



 **TSURUMI PUMP**™  
**BUILT FOR WORK**®  
SEWAGE AND WASTEWATER PUMPS



## SIMPLE DESIGN, EXTREME QUALITY | Tsurumi C Series CUTTER PUMP™

### Cable Entry

Cables are designed with an anti-wicking block at motor entry where each conductor insulation is window cut and the exposed stranded wire is encapsulated in molded rubber or epoxy which eliminates moisture from wicking into the motor.



### Motor

The air filled, continuous duty motors are designed to accommodate a maximum liquid temperature of 104°F. Higher temperature option is available upon request.

### Mechanical Seal

Design utilizes two silicon carbide seal faces, located within the oil chamber. The advantage being two-fold: eliminating corrosion, abrasion or fouling of the spring and seal faces due to contamination, and allowing constant cooling and lubrication of the seal faces, even in run-dry conditions. These are common points of failure in designs where the seal is lubricated by the pumpage.



### Oil Lifter

The Oil Lifter, utilizing centrifugal force, supplies lubricating oil to the upper seal faces even if lubricant falls below the rated volume, or pump is oriented horizontally.

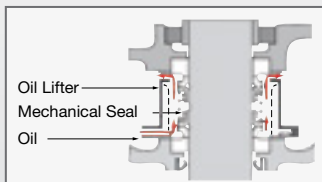

### Motor Protector

A Circle Thermal Protector (CTP) integrated in the motor housing directly cuts the motor circuit if excessive heat builds up or an overcurrent caused by an electrical or mechanical failure.

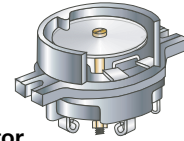

In pumps 15 HP and larger, a Miniature Thermal Protector (MTP) is embedded in each winding of larger motors.



Should the winding temperature rise to the actuating temperature, the bimetal strip opens to cause the control panel to shut the power supply.

### Moisture Sensor

An optional external sensor is available to detect the intrusion of water into the oil chamber and when wired to a control panel, alerts operator of this condition. An internal moisture sensor is standard for all pumps 30 HP and larger.



### Impeller & Cutter Plate

A tungsten carbide cutter is brazed onto the impeller vane, and rotates along the serrated entry of the cutter plate. Incoming fibrous matters are cut up which prevents clogging.



## GUIDE RAIL FITTING SYSTEM

The guide rail fitting system connects the pump to and from the piping easily just by lowering and hoisting the pump, allowing easy maintenance and inspection without the need to enter the sump. Pump models used in combination with the guide rail fitting system can be identified by the prefix "TO or TOS" and "TOK". Refer to standard specifications for availability and model numbers.

The **TOS / TO** is the standard guide rail fitting system made of cast-iron and is compatible with cast-iron pumps. Pumps having a discharge bore from 2 inches to 6 inches are available for the TOS, and from 8 inches to 32 inches are available for the TO.



The **TOK** guide rail connecting system is made of a high-quality corrosion resistant resin. This system is specifically designed for use with the corrosion resistant, light weight VANCS™ pumps (Page 16).



## MODEL NUMBER DESIGNATION

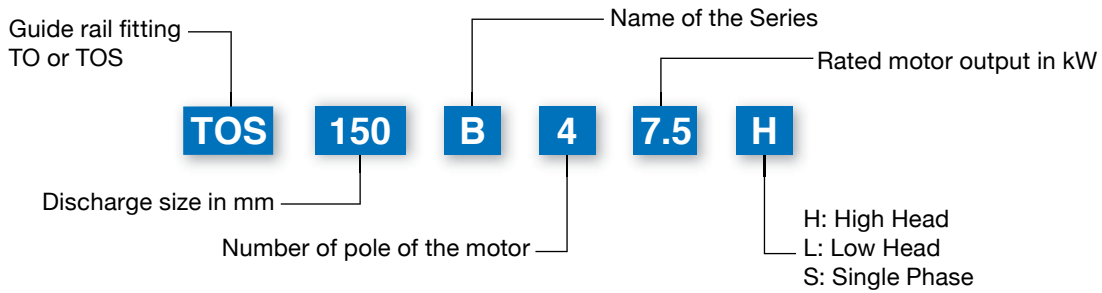

## INSTALLATION

### Free Standing

**Simple installation in the sump saves both money and space.**

This stationary pump, when equipped with flexible discharge hose, can easily be relocated out of the pit. Install the pump on a pump base if waste could clog or block its suction inlet.

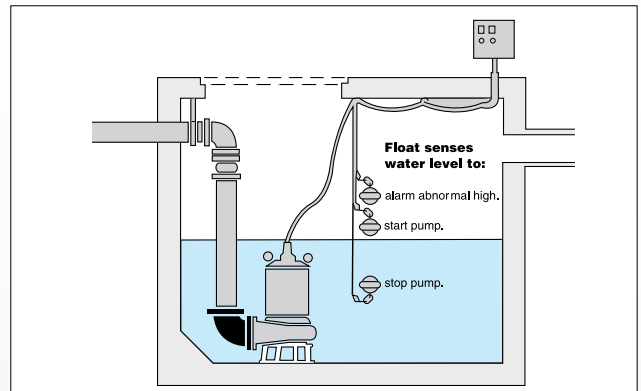

### Guide-Rail Fitting

**A guide rail suspends the pump with a chain for quick, easy installation or removal.**

Mount the pump on the rails using a guide hook at its discharge bore. Lower the pump, match the discharge bore flange to the discharge pipe flange. No need for bolting the flanges; pump weight prevents discharge pressure from separating the mated flanges. To disconnect, simply lift the pump.

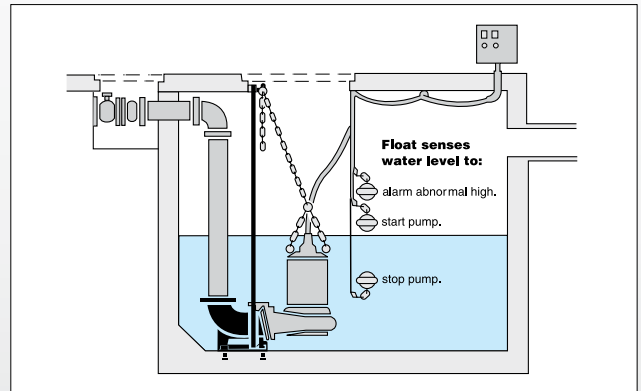

## DIMENSIONAL DRAWING DESCRIPTION

Dimension: Free Standing A / B / C

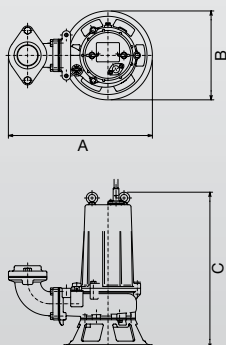

Dimension: Guide Rail Fitting (TO / TOS) D / E / F

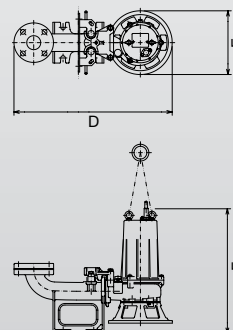

## B SERIES | Sewage & Wastewater Non-Clog Submersible Pump

Our B Series non-clog pumps are used primarily in municipal water supply stations and sewage treatment plants for pumping water, sewage, and digested sludge. In industry, these pumps are efficient for controlling cooling water, process and wastewater, and abrasive materials.

Solids handling, non-clog submersible pump designed for raw sewage and wastewater in municipal, industrial and commercial applications. Multiple impeller types for maximum flexibility. 2"- 8" discharge size.



100B42.2



With TO /TOS Guide Rail System

### Discharge Size: 2"- 3"

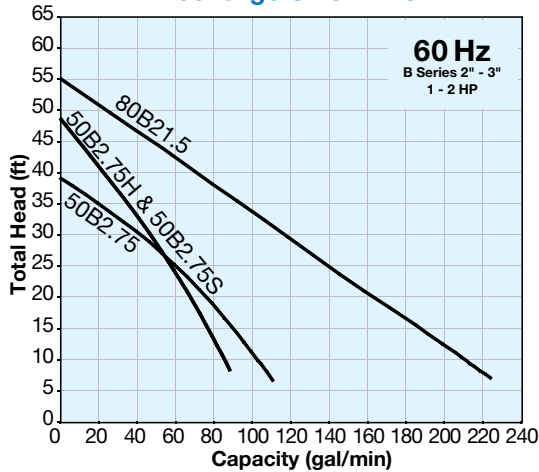

### Discharge Size: 4"

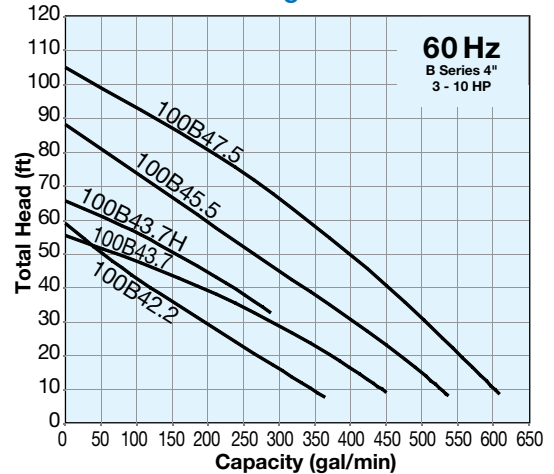

### Discharge Size: 6"

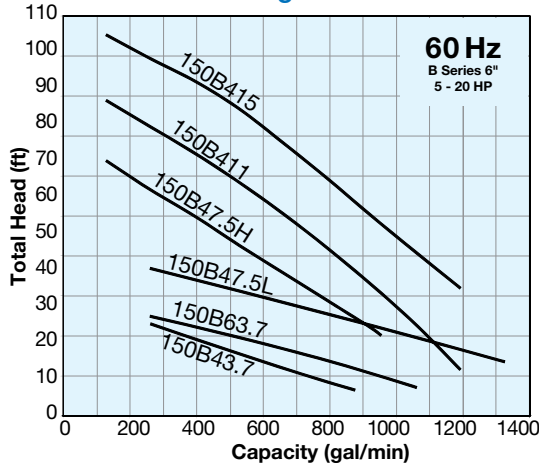

### Discharge Size: 8"

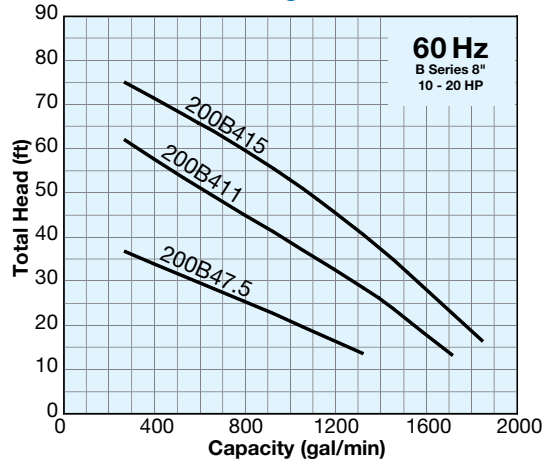

Impeller types for B series



With multiple impeller designs available in the B Series, Tsurumi has the right model to handle every application to efficiently transfer the most aggressive liquids.



Dimension: Free Standing A / B / C

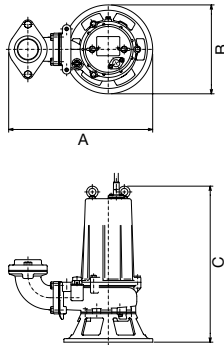

Dimension: Guide Rail Fitting (TO / TOS) D / E / F

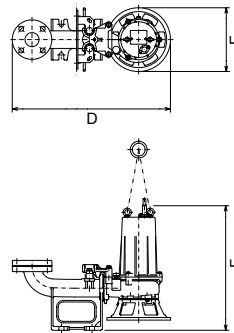

Single Phase Model	Motor Output (HP)	Rated Current (A)				*S.S. (RPM)	Discharge Size (in.)	Dimensions (in. / lbs.)						Max. Solids Dia. (in.)
		115V		230V				Free Standing Models			TOS Guide Rail Models			
		A	B	C	D			E	F					
50B2.75S	1	11.7	5.9			3600	2	15 15/16	9 13/16	20 9/16	24 7/16	9 13/16	9 13/16	0.79

Three Phase Model	Motor Output (HP)	Rated Current (A)				*S.S. (RPM)	Discharge Size (in.)	Dimensions (in. / lbs.)						Max. Solids Dia. (in.)
		208V	230V	460V	575V			Free Standing Models			TOS & TO Guide Rail Models			
		A	B	C	D			E	F					
50B2.75H	1	3.5	3.5	1.8	1.4	3600	2	15 15/16	9 13/16	16 5/16	24 7/16	9 13/16	18 1/16	0.79
50B2.75	1	3.5	3.5	1.8	1.4	3600	2	15 15/16	9 13/16	17 5/16	24 7/16	9 13/16	18 7/8	0.94
80B21.5	2	6.2	5.9	3.1	2.3	3600	3	17 9/16	9 13/16	21 1/8	26 5/8	9 13/16	23 1/16	1.38
100B42.2	3	9.4	8.5	4.3	3.5	1800	4 or 3	24 1/4	12 3/4	24 1/4	30 1/16	12 3/4	24 13/16	1.77
100B43.7H	5	15.0	13.8	6.9	5.4	1800	4 or 3	24 1/2	13 9/16	26 1/4	30 5/16	13 9/16	26 13/16	1.38
100B43.7	5	15.0	13.8	6.9	5.4	1800	4 or 3	24 1/2	13 1/8	27 3/16	30 5/16	13 1/8	27 9/16	1.77
150B43.7	5	15.3	13.8	6.9	5.4	1800	6	34 5/16	19 1/8	34 7/16	41 15/16	18 1/16	32 5/16	2.01
150B63.7	5	16.0	15.6	7.8	6.0	1200	6	33	16 11/16	35 9/16	40 1/2	15 9/16	36 7/16	2.17
100B45.5	7.5	22.2	20.8	10.4	8.3	1800	4	27 13/16	16 1/8	35 3/4	36	15 1/8	35 11/16	1.57
100B47.5	10	29.8	28.0	14.0	11.5	1800	4	27 13/16	16 1/8	36 9/16	36	15 1/8	36 1/2	1.57
150B47.5H	10	29.8	28.0	14.0	11.5	1800	6	32 13/16	16 7/16	37 1/2	40 1/2	15 7/8	38 7/16	2.76
150B47.5L	10	29.8	28.0	14.0	11.5	1800	6	34 5/16	19 1/8	42 11/16	41 15/16	18 1/16	40 9/16	1.97
200B47.5	10	29.8	28.0	14.0	11.5	1800	8	36 7/16	19 1/8	42 11/16	49 13/16	18 1/16	41 5/16	1.97
150B411	15	41.4	38.0	19.0	14.7	1800	6	35 1/4	19 5/16	43 3/16	42 7/8	18 1/4	41 7/16	2.95
200B411	15	41.4	38.0	19.0	14.7	1800	8	36 7/16	19 1/8	44 1/2	49 13/16	18 1/16	43 1/8	2.28
150B415	20	55.8	51.6	25.8	20.6	1800	6	35 1/4	19 5/16	45 15/16	42 7/8	18 1/4	44 3/16	2.95
200B415	20	55.8	51.6	25.8	20.6	1800	8	38 1/4	20 11/16	47 1/16	48 9/16	17 1/16	45 11/16	2.36

\* Synchronous Speed

## BK SERIES | Non-Clog Submersible Pump • Jacketed

The BK Series features with a standard built in internal cooling jacket design. The BK series offers continued cooling when low sump level may be present. Solids handling non-clog submersible pump featuring a standard cooling jacket for operating at low water levels without overheating. 30HP - 50HP, three phase. 6"-12" discharge sizes.

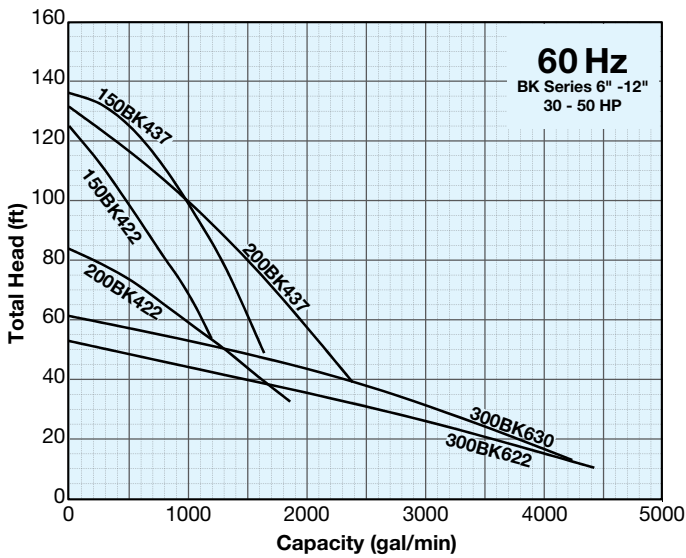

Dimension: Free Standing A / B / C

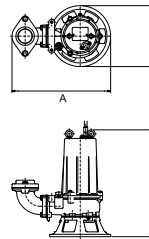

Dimension: Guide Rail Fitting (TO / TOS) D / E / F

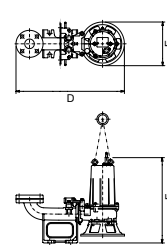

Three Phase Model	Motor Output (HP)	Rated Current (A)		*S.S. (RPM)	Discharge Size (in.)	Dimensions (in.)						Max. Solids Dia. (in.)
		460V	575V			Free Standing Models			TOS & TO Guide Rail Models			
						A	B	C	D	E	F	
150BK422	30	39	31.5	1800	6	38 7/8	21 1/4	52 1/8	46 1/4	20 1/2	51 5/16	2.95
200BK422	30	39	31.5	1800	8	42 13/16	24 7/16	51 15/16	53 3/8	21 5/8	51 15/16	2.95
300BK622	30	41	33	1200	12	53 3/4	29 15/16	63 9/16	66 5/16	27 3/8	63 11/16	3.27
300BK630	40	56	45	1200	12	53 3/4	29 15/16	67 3/16	66 5/16	27 3/8	67 5/16	2.76
150BK437	50	63	50	1800	6	42 11/16	28 1/2	63 11/16	51 7/16	24 7/16	57 1/16	1.57
200BK437	50	63	50	1800	8	46 7/8	28 1/2	64 9/16	56 1/4	24 3/8	60 1/8	1.57

\* Synchronous Speed

## BZ SERIES | Non-Clog Submersible Pump • Jacketed & Non-Jacketed

Highly reliable and durable, Tsurumi BZ Series pumps are designed and built for sound quality and continuous duty that can help you keep your systems - whether for wastewater drainage, pumping or flood control - running stably and greatly reduce your maintenance costs. As an option, the pumps can be adapted for seawater, high temperature liquids or other special application, paving the way for their use at shipyards and power plants for water intake and discharge.



100BZ47.5



250BZ455



200BZ622

### **Shrouded Channel Impeller with Wide Passages to Prevent Clogging**

#### **– Over 3 Inches Passage –**

BZ Series pumps come with wide passages of over 3 inches in diameter to minimize trouble due to clogged solids and fibrous matter. They adopt a shrouded single/two-channel impeller.



**Shrouded Channel Impeller**

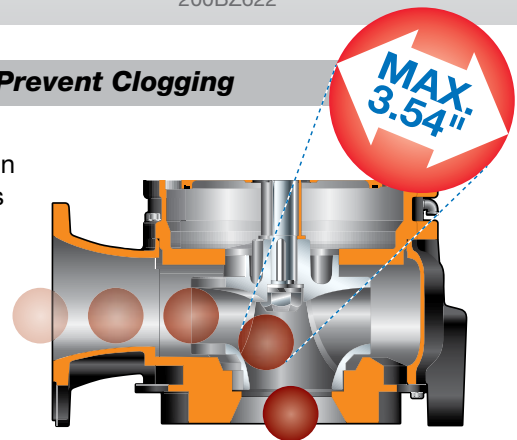

**BZ SERIES | Non-Clog Submersible Pump • Jacketed & Non-Jacketed**

**Group Curves**

**BZ Series: Jacketed**

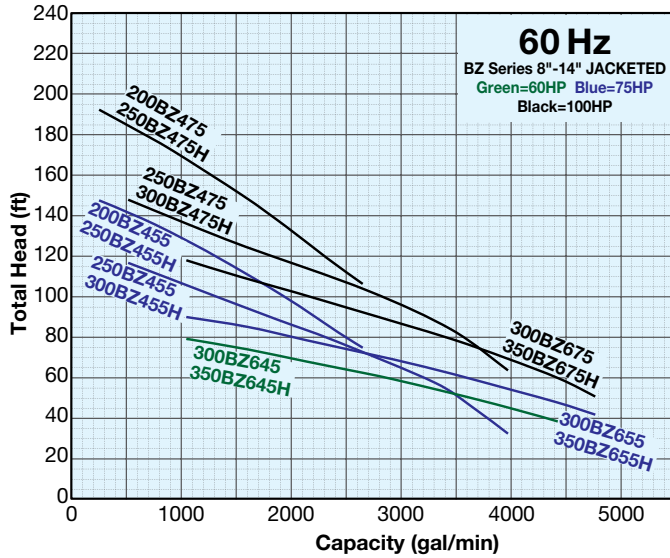

**BZ Series: Non-Jacketed**

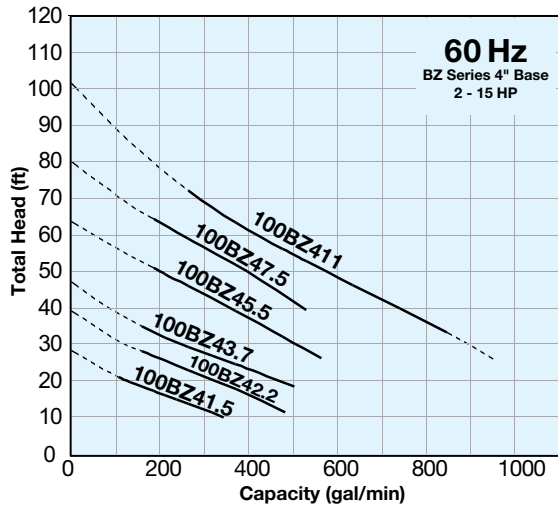

REMARKS: Not Recommended for Continuous Operation On Dashed Curve.

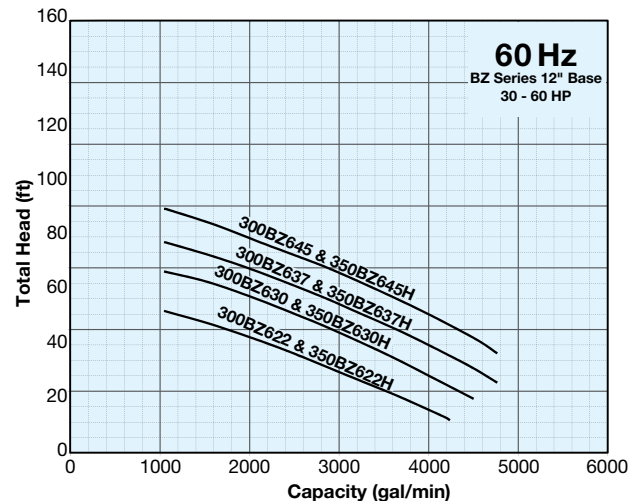
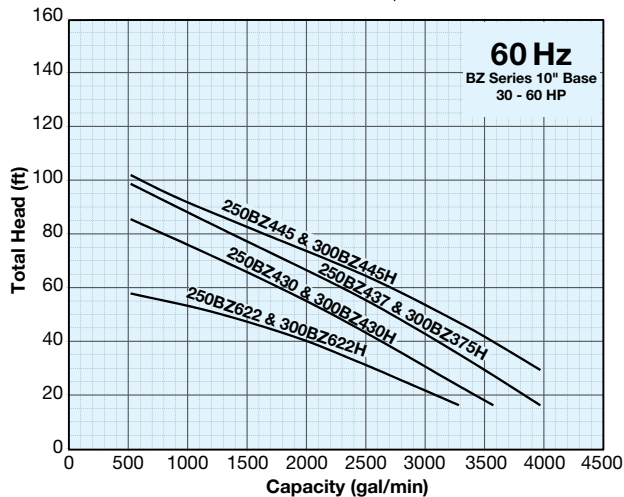
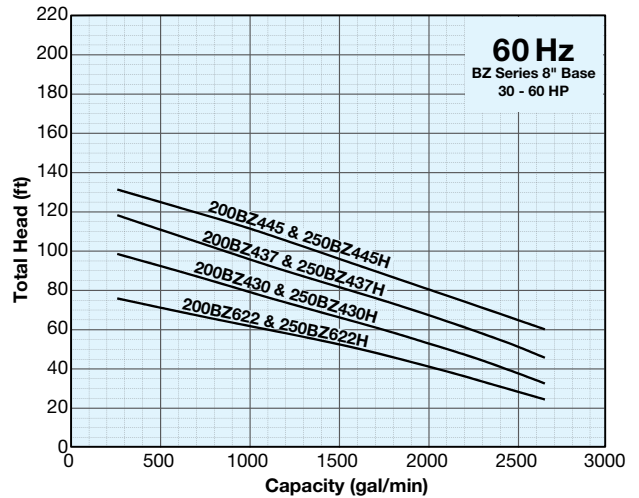



# BZ SERIES | Non-Clog Submersible Pump • Jacketed & Non-Jacketed

## Specifications

### BZ Series: Jacketed

Three Phase Model	Motor Output (HP)	Rated Current (A)				*S.S. (RPM)	Discharge Size (in.)	Dimensions (in.)						Max. Solids Dia. (in.)
		208V	230V	460V	575V			Free Standing Models			TOS Guide Rail Models			
								A	B	C	D	E	F	
200BZ455	75	N/A	N/A	CF	CF	1800	8	47 9/16	29 15/16	68 3/8	57 1/2	26	64 13/16	3.00
250BZ455H	75	N/A	N/A	CF	CF	1800	10	51 11/16	29 15/16	68 3/8	62 3/16	26	63 3/4	3.00
200BZ475	100	N/A	N/A	CF	CF	1800	8	47 9/16	29 15/16	68 3/8	57 1/2	26	64 13/16	3.00
250BZ475H	100	N/A	N/A	CF	CF	1800	10	51 11/16	29 15/16	68 3/8	62 3/16	26	63 3/4	3.00
250BZ455	75	N/A	N/A	CF	CF	1800	10	48 5/8	28 1/2	70 15/16	59 13/16	25 1/16	65 9/16	3.15
300BZ455H	75	N/A	N/A	CF	CF	1800	12	50 11/16	28 1/2	70 15/16	63 1/2	25 1/16	66 1/2	3.15
250BZ475	100	N/A	N/A	CF	CF	1800	10	48 5/8	28 1/2	70 15/16	59 13/16	25 1/16	65 9/16	3.15
300BZ475H	100	N/A	N/A	CF	CF	1800	12	50 11/16	28 1/2	70 15/16	63 1/2	25 1/16	66 1/2	3.15
300BZ645	60	N/A	N/A	CF	CF	1200	12	54 9/16	31 1/2	72 5/8	66 9/16	26 3/4	67 5/8	3.54
350BZ645H	60	N/A	N/A	CF	CF	1200	14	59 3/8	31 1/2	72 5/8	69 1/2	26 3/4	69 7/16	3.54
300BZ655	75	N/A	N/A	CF	CF	1200	12	54 9/16	31 1/2	72 5/8	66 9/16	26 3/4	67 5/8	3.54
350BZ655H	75	N/A	N/A	CF	CF	1200	14	59 3/8	31 1/2	72 5/8	69 1/2	26 3/4	69 7/16	3.54
300BZ475	100	N/A	N/A	CF	CF	1800	12	54 9/16	31 1/2	72	65 7/8	26 3/4	67	3.54
350BZ475H	100	N/A	N/A	CF	CF	1800	14	59 3/8	31 1/2	72	68 7/8	26 3/4	68 3/4	3.54

\* Synchronous Speed

### BZ Series: Non-Jacketed

Three Phase Model	Motor Output (HP)	Rated Current (A)				*S.S. (RPM)	Discharge Size (in.)	Dimensions (in.)						Max. Solids Dia. (in.)
		208V	230V	460V	575V			Free Standing Models			TOS Guide Rail Models			
								A	B	C	D	E	F	
100BZ41.5	2	8.0	8.0	4.0	3.0	1800	4	22 1/2	10 3/4	24 13/16	28 5/16	10 3/4	25 7/16	3.15
100BZ42.2	3	9.8	9.2	4.9	3.6	1800	4	22 1/2	10 3/4	24 13/16	28 5/16	10 3/4	25 7/16	3.15
100BZ43.7	5	15.0	14.2	7.3	5.4	1800	4	23 13/16	11 3/8	26 13/16	29 5/8	11 3/8	27 3/8	3.15
100BZ45.5	7.5	22.2	20.8	10.4	8.3	1800	4	29	16 9/16	36 7/16	37 3/16	16	36	3.15
100BZ47.5	10	29.8	28.0	14.0	11.5	1800	4	29	16 9/16	37 3/16	37 3/16	16	36 13/16	3.15
100BZ411	15	41.4	38.0	19.0	14.7	1800	4	29 7/16	16 15/16	40 1/4	37 5/8	16 7/8	40	3.15
200BZ622	30	N/A	N/A	CF	CF	1200	8	47 9/16	29 15/16	62 3/8	57 1/2	26	58 13/16	3.00
250BZ622H	30	N/A	N/A	CF	CF	1200	10	51 11/16	29 15/16	62 3/8	62 1/8	26	57 3/4	3.00
200BZ430	40	N/A	N/A	CF	CF	1800	8	47 9/16	29 15/16	59 3/16	57 1/2	26	55 1/2	3.00
250BZ430H	50	N/A	N/A	CF	CF	1800	10	51 11/16	29 15/16	59 3/16	62 1/8	26	54 1/2	3.00
200BZ437	50	N/A	N/A	CF	CF	1800	8	47 9/16	29 15/16	62 1/16	57 1/2	26	58 1/2	3.00
250BZ437H	50	N/A	N/A	CF	CF	1800	10	51 11/16	29 15/16	62 1/16	62 1/8	26	57 1/2	3.00
200BZ445	60	N/A	N/A	CF	CF	1800	8	47 9/16	29 15/16	62 3/8	57 1/2	26	58 13/16	3.00
250BZ445H	60	N/A	N/A	CF	CF	1800	10	51 11/16	29 15/16	62 3/8	62 1/8	26	57 3/4	3.00
250BZ622	30	N/A	N/A	CF	CF	1200	10	48 5/8	28 1/2	64 15/16	58 1/2	24 1/4	59 5/8	3.15
300BZ622H	30	N/A	N/A	CF	CF	1200	12	50 11/16	28 1/2	64 15/16	62 3/16	24 1/4	60 1/2	3.15
250BZ430	40	N/A	N/A	CF	CF	1800	10	48 5/8	28 1/2	61 13/16	58 1/2	24 1/4	56 7/16	3.11
300BZ430H	40	N/A	N/A	CF	CF	1800	12	50 11/16	28 1/2	61 13/16	62 3/16	24 1/4	57 3/8	3.11
250BZ437	50	N/A	N/A	CF	CF	1800	10	48 5/8	28 1/2	64 11/16	58 1/2	24 1/4	59 5/16	3.11
300BZ437H	50	N/A	N/A	CF	CF	1800	12	50 11/16	28 1/2	64 11/16	62 3/16	24 1/4	60 1/4	3.11
250BZ445	60	N/A	N/A	CF	CF	1800	10	48 5/8	28 1/2	64 15/16	58 1/2	24 1/4	59 5/8	3.11
300BZ445H	50	N/A	N/A	CF	CF	1800	12	50 11/16	28 1/2	64 15/16	62 3/16	24 1/4	60 1/2	3.11
300BZ622	30	N/A	N/A	CF	CF	1200	12	54 9/16	31 1/2	66	65 7/8	25 7/8	61	3.54
350BZ622H	30	N/A	N/A	CF	CF	1200	14	59 3/8	31 1/2	66	68 7/8	25 7/8	62 13/16	3.54
300BZ630	40	N/A	N/A	CF	CF	1200	12	54 9/16	31 1/2	66	65 7/8	25 7/8	61	3.54
350BZ630H	40	N/A	N/A	CF	CF	1200	14	59 3/8	31 1/2	66	68 7/8	25 7/8	62 13/16	3.54
300BZ637	50	N/A	N/A	CF	CF	1200	12	54 9/16	31 1/2	66	65 7/8	25 7/8	61	3.54
350BZ637H	50	N/A	N/A	CF	CF	1200	14	59 3/8	31 1/2	66	68 7/8	25 7/8	62 13/16	3.54

\* Synchronous Speed

Dimension: Free Standing A / B / C

Dimension: Guide Rail Fitting (TO / TOS) D / E / F

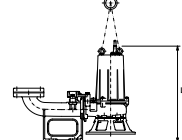
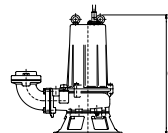
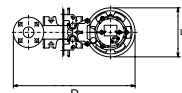
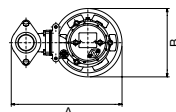

## C SERIES | Tsurumi C Series CUTTER PUMP™

Tsurumi C Series Cutter Pump™ is solids handling non-clog submersible pump with a unique tungsten carbide tipped single or multi-vane impeller and high chrome serrated wear plate for shredding of solids. Municipal, industrial and commercial applications. 1HP to 30HP, Single phase and three phase available.

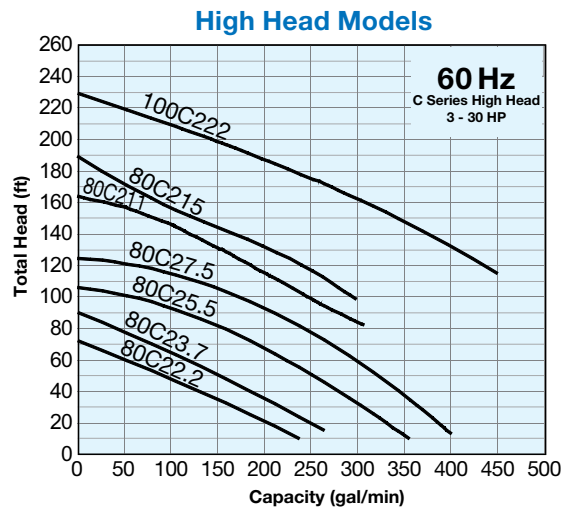
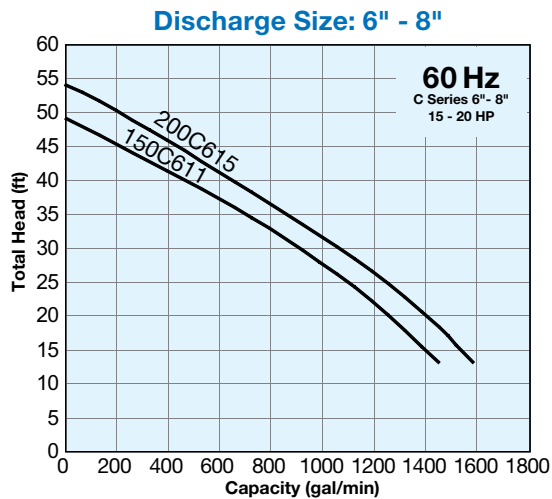
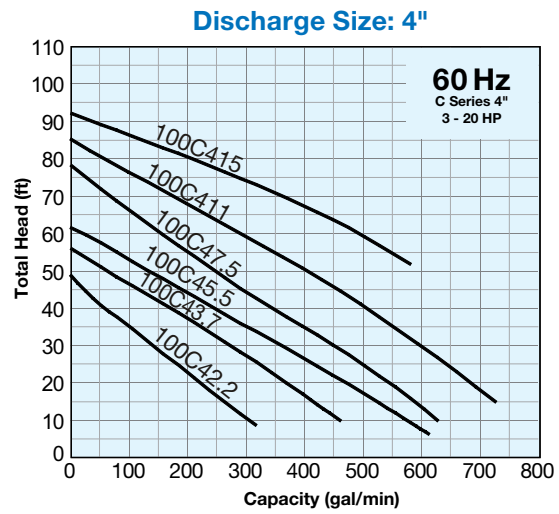
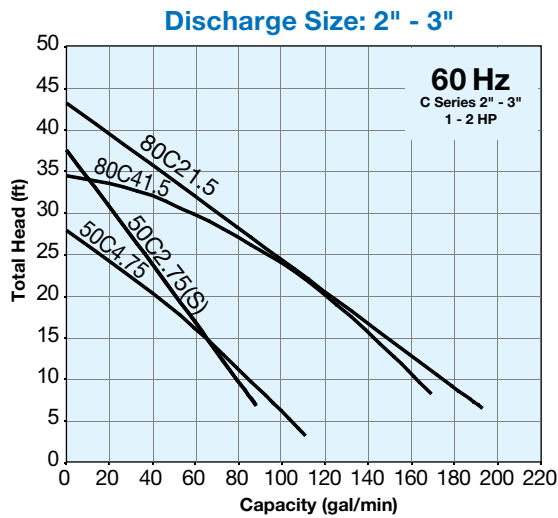

## Applications

- Municipal wet well lift stations
- Municipal dry pit stations
- Retail stores / restaurants
- Sewer bypass
- Nursing homes / housing developments
- Prisons
- Hospitals
- Pulp and paper mills
- Industrial processing
- Oil refining
- Food processing
- Farming
- Campgrounds
- Hotels

## Optional Discharge with 3" & 4" Discharge Size

Reduced overall width allows pump to be used in confined areas, including sewer bypass applications. Please contact factory for specific dimensions. (Also compatible with other models)



Dimension: Free Standing A / B / C

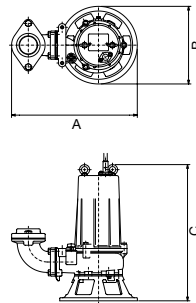

Dimension: Guide Rail Fitting (TO / TOS) D / E / F

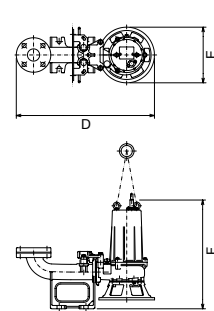

Single Phase Model	Motor Output (HP)	Rated Current (A)				*S.S. (RPM)	Discharge Size (in.)	Dimensions (in.)						Max. Solids Dia. (in.)
		115V		230V				Free Standing Models			TOS Guide Rail Models			
		A	B	C	D			E	F					
50C2.75S*	1	11.7	5.9			3600	2	15 15/16	9 13/16	20 9/16	24 7/16	9 13/16	22 5/16	0.827

Three Phase Model	Motor Output (HP)	Rated Current (A)				*S.S. (RPM)	Discharge Size (in.)	Dimensions (in.)						Max. Solids Dia. (in.)
		208V	230V	460V	575V			Free Standing Models			TOS Guide Rail Models			
		A	B	C	D			E	F					
50C2.75*	1	3.5	3.5	1.8	1.4	3600	2	15 15/16	9 13/16	16 5/16	24 7/16	9 13/16	18 1/16	0.827
50C4.75	1	3.5	3.6	1.8	1.5	3600	2	16 13/16	11 3/16	19 5/8	25 5/16	11 3/16	21 9/16	1.02
80C21.5*	2	6.2	5.9	3.1	2.3	3600	3	17 9/16	9 13/16	21 1/8	26 5/8	9 13/16	23 1/16	1.18
80C41.5	2	6.6	6.4	3.2	2.6	1800	3	19 5/8	12 7/16	22 5/8	28 11/16	12 7/16	23 7/8	1.26
100C42.2	3	9.4	8.5	4.3	3.5	1800	4 or 3	24 3/16	12 3/4	24 1/4	30 1/16	12 3/4	24 13/16	1.73
100C43.7	5	15.0	13.8	6.9	5.4	1800	4 or 3	24 3/8	13 1/8	27 3/16	30 1/4	13 1/8	27 9/16	2.17
100C45.5	7.5	22.2	20.8	10.4	8.3	1800	4	27 13/16	16 1/8	35 3/4	36	15 1/8	35 11/16	1.57
100C47.5	10	29.8	28.0	14.0	11.5	1800	4	27 13/16	16 1/8	36 9/16	36	15 1/8	36 1/2	1.57
100C411	15	41.4	38.0	19.0	14.7	1800	4	28 11/16	17 3/16	39 3/8	36 15/16	16 15/16	39 5/16	1.97
100C415	20	55.8	51.6	25.8	20.6	1800	4	28 5/8	17 3/16	42 1/2	36 7/8	16 11/16	42 7/16	1.57
150C611	15	43	40	20	16	1200	6	41 1/16	23 11/16	47 11/16	48 3/8	22	46 5/16	3.62
200C615	20	58	52	26	21	1200	8	43 1/4	23 11/16	49 5/8	56 1/4	22	49 1/16	3.62

\* Not for use in commercial applications (Residential sewage only)

Three Phase Model: High Head	Motor Output (HP)	Rated Current (A)				*S.S. (RPM)	Discharge Size (in.)	Dimensions (in.)						Max. Solids Dia. (in.)
		208V	230V	460V	575V			Free Standing Models			TOS Guide Rail Models			
		A	B	C	D			E	F					
80C22.2	3	10.0	9.8	4.9	3.8	3600	3	21 1/8	10 1/4	24 1/16	27 5/16	10 1/4	25 3/16	0.787
80C23.7	5	14.4	13.6	6.8	5.3	3600	3	21 1/8	10 1/4	24 1/16	27 5/16	10 1/4	25 3/16	0.866
80C25.5	7.5	22.3	21.4	10.7	8.3	3600	3	24 15/16	13 9/16	34 5/8	31	12 5/8	34 1/2	0.906
80C27.5	10	26.9	25.6	12.8	10.2	3600	3	24 15/16	13 9/16	34 5/8	31	12 5/8	34 1/2	0.906
80C211	15	40.8	39.2	19.6	15.4	3600	3	24 15/16	13 9/16	36 1/2	31	12 5/8	36 7/16	0.984
80C215	20	54	50	25	20.0	3600	3	28 3/4	16 15/16	42 3/4	36 7/8	16 15/16	42 3/4	1.02
100C222	30	---	---	35	28	3600	4	33 3/4	20 1/16	46 5/8	40 3/8	20 1/16	46 5/8	1.02

\* S.S. = Synchronous Speed

## U SERIES | Semi-Vortex Cast Iron Impeller

Tsurumi's U Series pumps provide exceptional capabilities for those small to mid-range applications in which solids and stringy materials can be problematic.

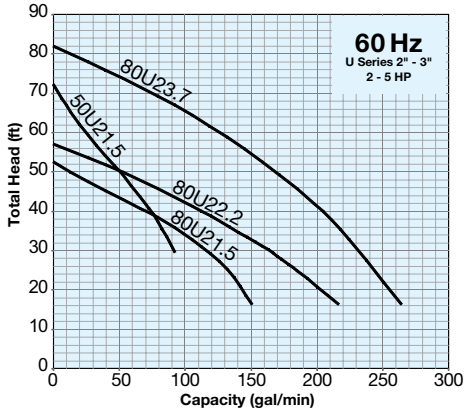

U Series pump with elbow

Dimension: Free Standing A / B / C    Dimension: Guide Rail Fitting (TO / TOS) D / E / F

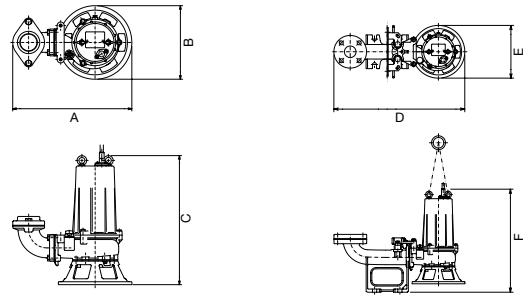

Three Phase Model	Motor Output (HP)	Rated Current (A)				*S.S. (RPM)	Discharge Size (in.)	Dimensions (in.)						Max. Solids Dia. (in.)
		208V	230V	460V	575V			Free Standing Models			TOS Guide Rail Models			
								A	B	C	D	E	F	
50U21.5	2	6.2	5.9	3.1	2.3	3600	2	11 11/16	7 15/16	18 3/8	25 7/8	7 15/16	18 13/16	1.38
80U21.5	2	6.2	5.9	3.1	2.3	3600	3	16 9/16	7 15/16	19 5/8	24 1/8	7 15/16	23 11/16	1.81
80U22.2	3	9.4	8.8	4.4	3.5	3600	3	20 1/29	9 7/16	22 1/8	25 1/4	9 7/16	25 1/2	2.20
80U23.7	5	14.4	13.6	6.8	5.3	3600	3	20 1/29	9 3/16	22 1/4	25 1/4	9 3/16	25 9/16	1.81

\* Synchronous Speed

## UT • UTZ SERIES | Single Phase Cast Iron Submersible Sewage Pump

The UT pump is a compact economical cast iron pump, which has a large passage that makes it ideal for liquid containing various solids. Available in automatic operation (50UTZ2.4S / 2.75S), which are equipped with floats.

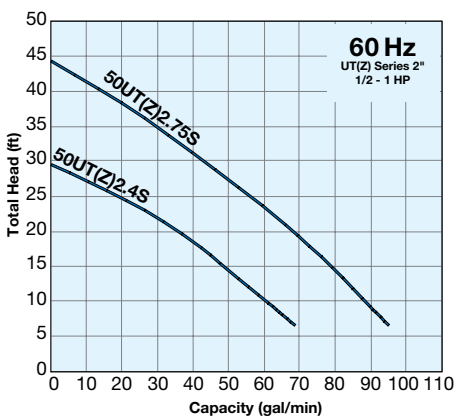

50UT2.4S



50UTZ2.4S

Dimension: 50UT2.4S/2.75S

Dimension: 50UTZ2.4S/2.75S

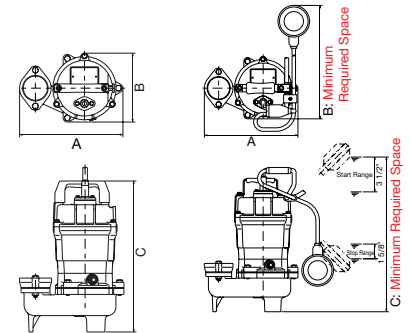

Single Phase Model	Motor Output (HP)	Rated Current (A)		*S.S. (RPM)	Discharge Size (in.)	Dimensions (in.)			Max. Solids Dia. (in.)
		115V	230V			Free Standing Models			
						A	B	C	
50UT2.4S	1/2	5.7	3.4	3600	2	9 1/2	6 3/8	13 3/4	1.40
50UTZ2.4S	1/2	5.7	3.4	3600	2	9 1/2	11 5/8 <sup>*1</sup>	15 3/4 <sup>*1</sup>	1.40
50UT2.75S	1	9.9	5.2	3600	2	9 1/2	6 3/8	16	1.40
50UTZ2.75S	1	9.9	5.2	3600	2	9 1/2	11 5/8 <sup>*1</sup>	18 <sup>*1</sup>	1.40

(Suffix Z: Automatic Operation)

\* Synchronous Speed

<sup>\*1</sup>: Minimum Required Space

## UZ SERIES | Full-Vortex Cast Iron Impeller

Features a vortex impeller and wide pump casing interior, effectively pumping and discharging water containing solids and fibrous foreign matters.



UZ Series pump with elbow



With TOS Guide Rail System

### Discharge Size: 2" - 3"

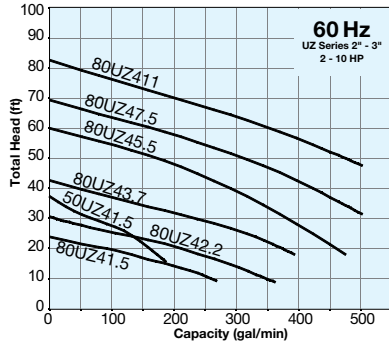

### Discharge Size: 4"

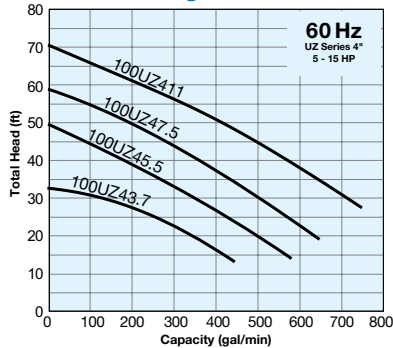

Dimension: Free Standing A / B / C

Dimension: Guide Rail Fitting (TO / TOS) D / E / F

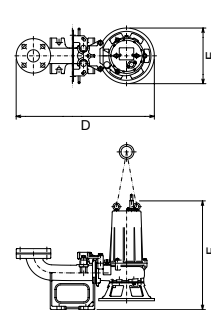
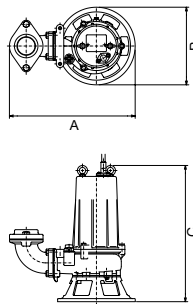

Three Phase Model	Motor Output (HP)	Rated Current (A)				*S.S. (RPM)	Discharge Size (in.)	Dimensions (in.)						Max. Solids Dia. (in.)
		208V	230V	460V	575V			Free Standing Models			TOS Guide Rail Models			
								A	B	C	D	E	F	
50UZ41.5	2	7.3	7.0	3.5	2.9	1800	2	15 15/16	9 3/4	22 5/16	24 7/16	9 3/4	24 5/8	1.97
80UZ41.5	2	7.3	7.0	3.5	2.9	1800	3	21 5/8	10 1/4	25 1/16	28 1/16	10 1/4	26 3/8	3.15
80UZ42.2	3	9.4	8.5	4.3	3.5	1800	3	21 5/8	10 1/4	25 1/16	28 1/16	10 1/4	26 3/8	3.15
80UZ43.7	5	15.0	13.8	6.9	5.4	1800	3	22 11/16	11 7/16	27 1/16	29 1/8	11 7/16	28 3/8	3.15
100UZ43.7	5	15.0	13.8	6.9	5.4	1800	4	25 1/2	12 3/8	29	33 11/16	12 3/8	30 9/16	3.94
80UZ45.5	7.5	22.2	20.8	10.4	8.3	1800	3	24 1/8	14 1/8	35 3/8	30 9/16	14 1/8	36 1/2	3.15
100UZ45.5	7.5	22.2	20.8	10.4	8.3	1800	4	26 7/16	14 1/8	36 15/16	34 11/16	14 1/8	38 3/8	3.94
80UZ47.5	10	29.8	28.0	14.0	11.5	1800	3	24 1/8	14 1/8	36 1/4	30 9/16	14 1/8	37 5/16	3.15
100UZ47.5	10	29.8	28.0	14.0	11.5	1800	4	26 7/16	14 1/8	37 13/16	34 11/16	14 1/8	39 3/16	3.94
80UZ411	15	41.4	38.0	19.0	14.7	1800	3	24 7/16	14 1/8	38 5/8	30 7/8	14 1/8	39 5/8	3.15
100UZ411	15	41.4	38.0	19.0	14.7	1800	4	26 3/4	14 1/8	40 3/16	35	14 1/8	41 1/2	3.94

\* Synchronous Speed

## MG SERIES | Semi-Vortex High Chrome Impeller

Foreign matter is finely ground up by the built-in grinder mechanism and discharged by a vortex impeller. Tsurumi submersible grinder pumps utilize a grinding mechanism in the suction port to crush foreign matter into fine particles before discharging the waste.

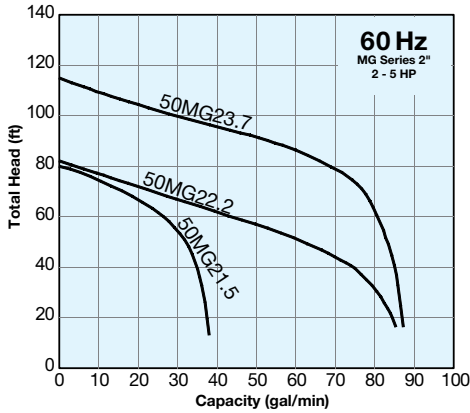

Grinding Mechanism

Dimension: Free Standing A / B / C    Dimension: Guide Rail Fitting (T0 / TOS) D / E / F

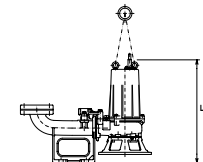
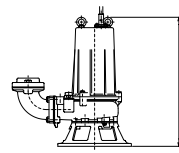
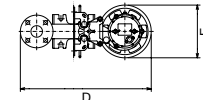
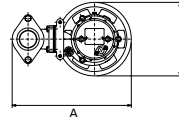

Three Phase Model	Motor Output (HP)	Rated Current (A)				*S.S. (RPM)	Discharge Size (in.)	Dimensions (in.)						Max. Solids Dia. (in.)
		208V	230V	460V	575V			Free Standing Models			TOS Guide Rail Models			
								A	B	C	D	E	F	
50MG21.5	2	6.7	6.6	3.3	2.6	3600	2	14 5/16	8 9/16	21 15/16	24 7/16	8 9/16	23 1/8	0.197
50MG22.2	3	10.0	9.8	4.9	3.8	3600	2	17 1/4	8 7/8	23 3/8	24 7/16	8 7/8	24 11/16	0.197
50MG23.7	5	14.4	13.6	6.8	5.3	3600	2	17 1/4	8 7/8	23 3/8	24 7/16	8 7/8	24 11/16	0.197

\* Synchronous Speed

## SQ SERIES | Compact & Lightweight Corrosion Resistant Pump

The SQ pump features a top discharge, flow-thru design with forced motor cooling that enables extended running at low water level. In addition, the SQ pump fits into an 8-inch pipe.

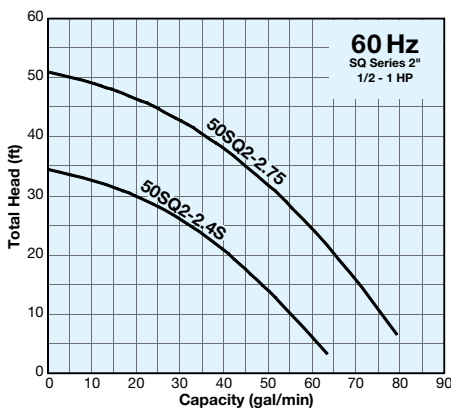

- It is made of 304 / 316 stainless steel, Nitrile Butadiene Rubber and special resin to stand up to rust and corrosion, and sport a new structural design that makes them even lighter and easier to carry
- Non-toxic white mineral oil used to lubricate mechanical seals allows for use in food / agriculture industries
- Motor protector protects against overheating and run-dry
- Designed to fit into an 8-inch pipe



50SQ2-2.4S

Single Phase Model	Motor Output (HP)	Rated Current (A)		*S.S. (RPM)	Discharge Size (in.)	Dimensions (in.)			Max. Solids Dia. (in.)		
		115V	230V			Free Standing Models					
		A	B	C							
50SQ2-2.4S	1/2	5.1	2.9	3600	2	7 1/16	7 1/16	14 7/16	0.236		
Three Phase Model	Motor Output (HP)	Rated Current (A)				*S.S. (RPM)	Discharge Size (in.)	Dimensions (in.)			Max. Solids Dia. (in.)
		208V	220V	460V	575V			Free Standing Models			
		A	B	C							
50SQ2-2.75	1	3.4	3.5	2.0	1.5	3600	2	7 1/16	7 1/16	15 3/16	0.236

\* Synchronous Speed

Dimension: Free Standing

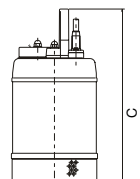
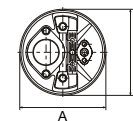

## SFQ SERIES | Stainless Steel Pump

Submersible drainage/dewatering pump designed for corrosive liquids and atmospheres. All cast 316 Stainless Steel construction with viton elastomers and semi-open Stainless Steel impeller type. Three phase, 1HP - 15HP models at 208V - 230V, 460V and 575V & 2", 3" and 4" discharge sizes.



80SFQ211

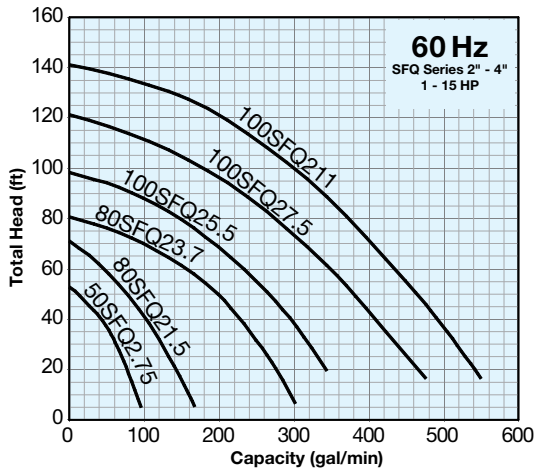

- All wetted material components are 316 Stainless Steel
- Dual inside mechanical seals with Silicon Carbide faces, running in an oil filled chamber and further protected by exclusionary lip seal, providing the most durable seal available
- Optional 316 Stainless Steel slide rail system is available for models from 7.5HP - 15HP
- Seal pressure relief system features an independent chamber separate from the oil casing in which the mechanical seal is housed
- Optional: High temperature winding (available on all series)

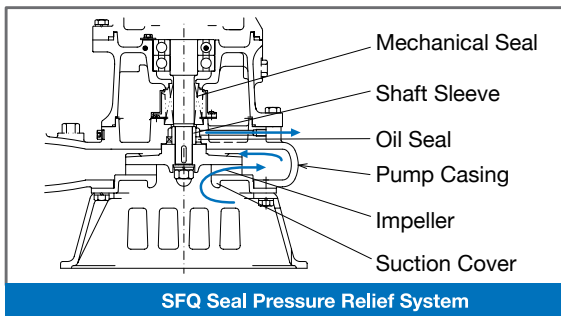

Dimension: Free Standing A / B / C

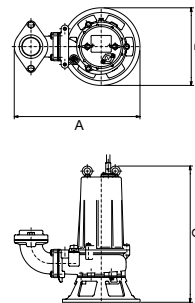

Dimension: Guide Rail Fitting (TO / TOS) D / E / F

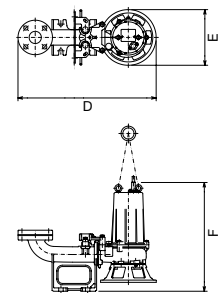

Three Phase Model	Motor Output (HP)	Rated Current (A)				*S.S. (RPM)	Discharge Size (in.)	Dimensions (in.)						Max. Solids Dia. (in.)
		208V	230V	460V	575V			Free Standing Models			TO Guide Rail Models			
								A	B	C	D	E	F	
50SFQ2.75	1	3.5	3.1	1.6	1.4	3600	2	9 15/16	7 11/16	15 11/16	N/A	N/A	N/A	0.236
80SFQ21.5	2	6.9	6.7	3.4	2.7	3600	3	12 15/16	8 11/16	19 1/16	N/A	N/A	N/A	0.236
80SFQ23.7	5	13.8	12.8	6.4	5.0	3600	3	14 1/8	10 1/8	21 5/16	N/A	N/A	N/A	0.591
100SFQ25.5	7.5	19.3	18.2	9.4	7.5	3600	4	25 3/8	14 3/16	33 1/4	37 3/16	14 3/16	35 7/8	0.787
100SFQ27.5	10	26.0	24.4	12.2	9.5	3600	4	25 3/8	14 3/16	33 1/4	37 3/16	14 3/16	35 7/8	0.787
100SFQ211	15	37.0	35.2	17.6	13.9	3600	4	25 3/8	14 3/16	35 1/8	37 3/16	14 3/16	37 13/16	0.906

\* Synchronous Speed

The **VANCS™ - OM, PU, PN, PSF and TM Series** submersible pump is designed for handling raw sewage, wastewater, industrial and commercial sump pump applications. The VANCS™ pumps have a proven track record for offering long lifecycles in both continuous and intermittent sump applications. With the pump made of complete molded resin material and all other parts coming in contact with the pump liquid in either 304 Stainless Steel or Titanium.

**VANCS™**



- Residential, commercial, industrial, effluent, wastewater and site drainage
- Chemical spill containment
- Raw water supply from rivers or lakes
- For TM Series: Titanium components increases corrosion resistance in a wide variety of applications. Ideal use for salt wastewater, site drainage and bilge pumps
- Automatic Operation (A) and Auto Alternating Operation (W) are available

✓ **VANCS™ Pumps: TOK Guide Rail Fitting System**

The TOK guide rail fitting system connects the pump to and from the piping easily just by lowering and hoisting the pump, allowing easy maintenance and inspection without the need to enter the sump.

Made of high-quality resin, the TOK is designed for lightweight, small to middle sized pumps. Rubber bellows attached to the guide hook are inverted to the duckfoot bend when the pump starts operating, and it seals by the pumping pressure. This eliminates leakage at the seal even if a lightweight pump is used in combination with the TOK.

The TOK is available in all motor output ranges of the PU, PN, and PSF Series.

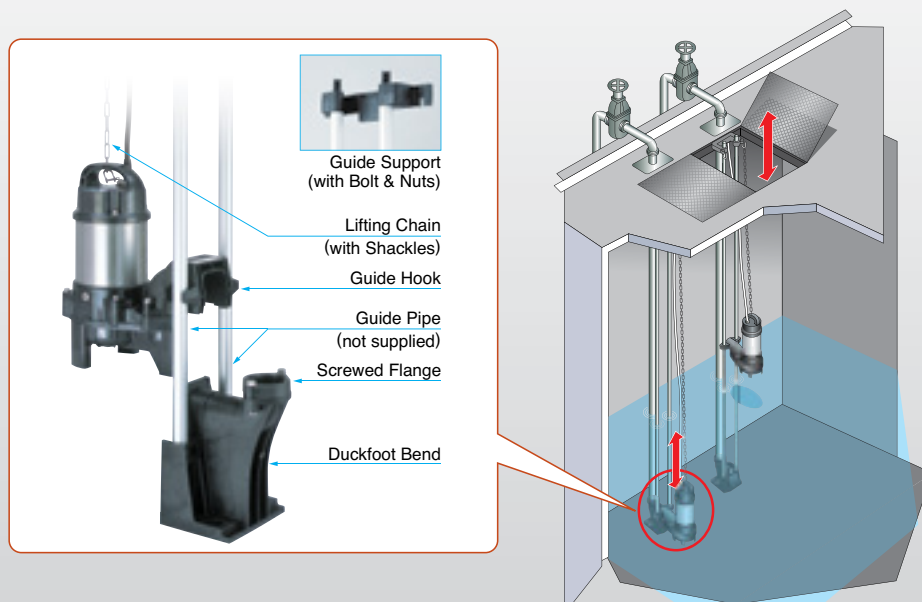



**Automatic & Auto-Alternation Models**

The VANCS™ pumps are available with automatic duplexing capabilities eliminating the need for a duplexing control panel\*. The auto-alternating model has three floats and can be identified by the suffix “W”. Refer to standard specifications for availability and model numbers. It is available in the same output range of the automatic pumps.

*\*Note: Must be installed in accordance with all National or Local Electrical or Building Codes.*



PNA: Automatic (A) Model      PUW: Auto-alternation (W) Model

**VANCS™ Pumps: Selection Table**

Category	Series	Discharge Size inch	Impeller	Model	Motor Output HP							
					1/5	1/3	1/2	1	2	3	5	
Wastewater	OM	1.5	Vortex	Standard	Available							
				Automatic (A)	Available							
Wastewater	PN	2 – 3	Vortex	Standard		Available	Available	Available	Available	Available	Available	Available
				Automatic (A)		Available	Available	Available	Available	Available	Available	Available
				Auto-alternation (W)		Available	Available	Available	Available	Available	Available	Available
Wastewater -High Head-	PSF	2 – 3	Closed	Standard		Available	Available	Available	Available	Available	Available	Available
				Automatic (A)		Available	Available	Available	Available	Available	Available	Available
				Auto-alternation (W)		Available	Available	Available	Available	Available	Available	Available
Sewage	PU	2– 3	Vortex	Standard	Available	Available	Available	Available	Available	Available	Available	Available
				Automatic (A)	Available	Available	Available	Available	Available	Available	Available	Available
				Auto-alternation (W)	Available	Available	Available	Available	Available	Available	Available	Available
Seawater	TM	2 – 3	Vortex	Standard		Available	Available	Available	Available	Available	Available	
				Automatic (A)		Available	Available	Available	Available	Available	Available	Available

**VANCS™ Pumps: Type of Impeller**

**Vortex**



The vortex impeller is adopted in every series except for the PSF Series. Rotation of the impeller produces a whirling, centrifugal action between the impeller and the pump casing, and it moves the fluid through the pump. Being coupled with a wide pump casing, wastewater containing solid matters can be pumped out without obstruction.

**Closed**



The closed impeller is adopted in the PSF Series. The impeller is also referred to as shrouded impeller, as it has circular shrouds at both sides of the impeller vanes. Although the pump has a limited solids passage capability, it can be used for higher pumping head applications.

**VANCS™ Pumps Group Curves**

**OM Series**

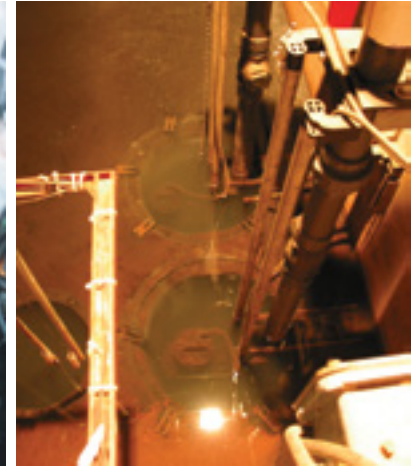
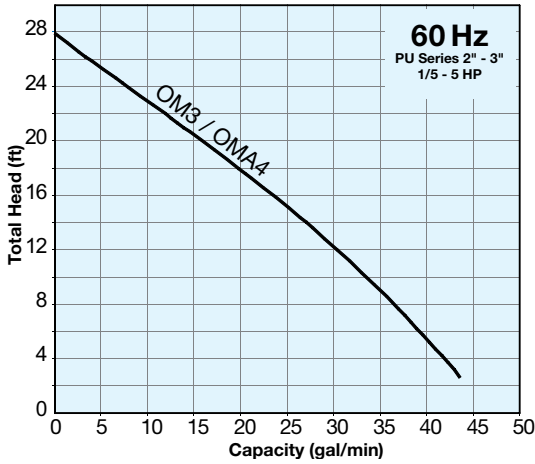

**PN Series**

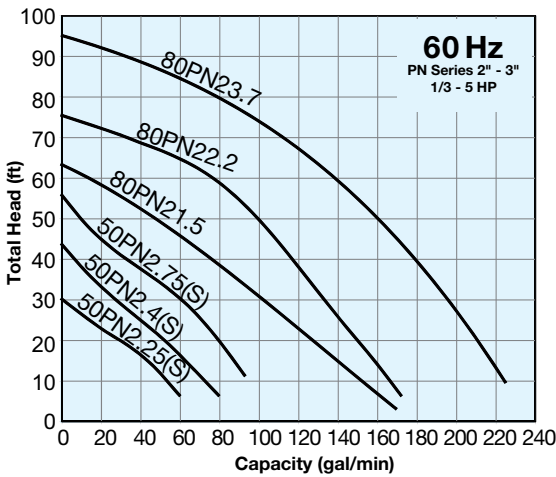

**PSF Series**

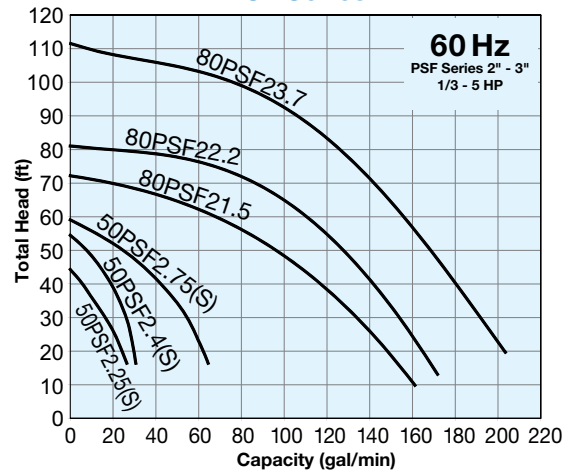

**PU Series**

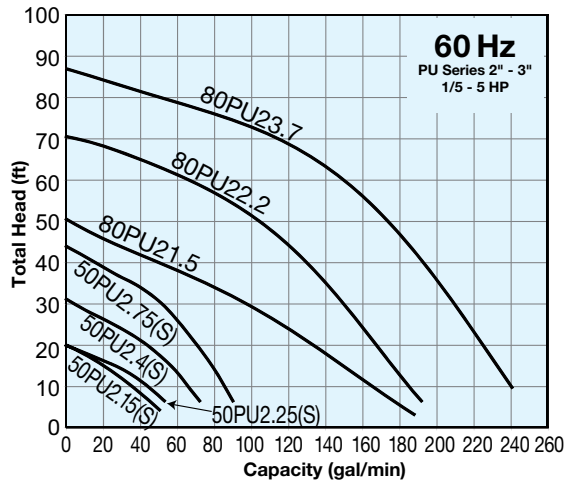

**TM Series**

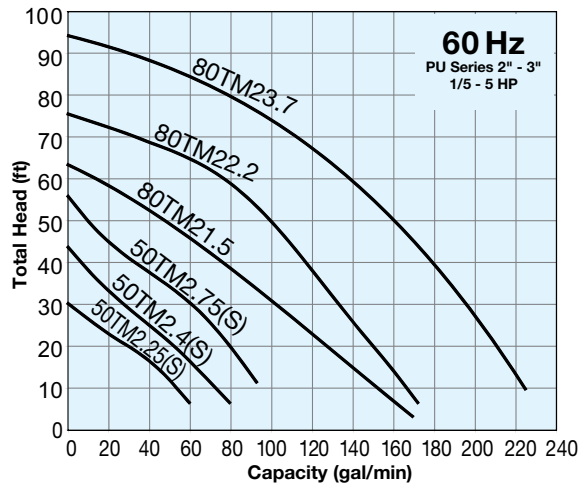

# VANCS™ Pumps Specifications

\* S.S. = Synchronous Speed

OM Series	Single Phase Model	Motor Output (HP)	Rated Current (A)		*S.S. (RPM)	Discharge Size (in.)	Dimensions (in.)			Max. Solids Dia. (in.)
			115V	230V			Free Standing Models			
			A	B			C			
OM3 ★	1/5	3.2	1.6	3600	1.5	8	5 1/2	12 7/16	0.394	
OMA4 ★	1/5	3.2	1.6	3600	1.5	8	7	12 5/8	0.394	

★ For VANCS™ pumps 1HP and smaller: These pumps should not be operated on a VFD. Contact factory for more information.

PN Series	Single Phase Model	Motor Output (HP)	Rated Current (A)				*S.S. (RPM)	Discharge Size (in.)	Dimensions (in.)						Max. Solids Dia. (in.)
			115V		230V				Free Standing Models			TOK Guide Rail Models			
			A	B	C	D			E	F					
50PN2.25S ★	1/3	4.6	2.3	3600	2	9 5/16	6 3/8	14 3/16	17 3/16	6 3/8	15 3/16	0.394			
50PN2.4S ★	1/2	5.8	2.9	3600	2	9 5/16	6 3/8	14 3/16	17 3/16	6 3/8	15 3/16	0.394			
50PN2.75S ★	1	9.2	4.6	3600	2	9 5/16	6 3/8	14 15/16	17 3/16	6 3/8	16	0.394			
PN Series	Three Phase Model	Motor Output (HP)	Rated Current (A)				*S.S. (RPM)	Discharge Size (in.)	Dimensions (in.)						Max. Solids Dia. (in.)
			208V	220V	460V	575V			Free Standing Models			TOK Guide Rail Models			
			A	B	C	D			E	F					
50PN2.25 ★	1/3	1.65	1.6	0.75	---	3600	2	9 5/16	6 3/8	13 3/4	17 3/16	6 3/8	14 3/4	0.394	
50PN2.4 ★	1/2	2.1	2.0	0.95	---	3600	2	9 5/16	6 3/8	14 3/16	17 3/16	6 3/8	15 3/16	0.394	
50PN2.75 ★	1	3.2	3.2	1.5	---	3600	2	9 5/16	6 3/8	14 3/4	17 3/16	6 3/8	15 3/4	0.394	
80PN21.5	2	6.9	6.6	*3.6	---	3600	3	11 5/8	7 11/16	17 1/8	20 11/16	7 11/16	19 5/16	0.787	
80PN22.2	3	9.1	8.5	4.2	3.3	3600	3	12 1/4	8 3/8	22	21 5/16	8 3/8	23 3/8	0.787	
80PN23.7	5	14.4	13.4	6.5	5.0	3600	3	12 1/4	8 3/8	23 3/8	21 5/16	8 3/8	24 3/4	0.787	

\*440V

Dimension: Free Standing (PU, PN, PSF, TM, OM Series)

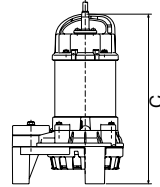
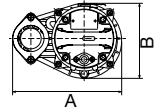

PSF Series	Single Phase Model	Motor Output (HP)	Rated Current (A)				*S.S. (RPM)	Discharge Size (in.)	Dimensions (in.)						Max. Solids Dia. (in.)
			115V	230V	Free Standing Models				TOK Guide Rail Models						
			A	B	C	D			E	F					
50PSF2.25S ★	1/3	4.6	2.3	3600	2	9 5/16	6 3/8	14 3/16	17 3/16	6 3/8	15 3/16	0.315			
50PSF2.4S ★	1/2	5.8	2.9	3600	2	9 5/16	6 3/8	14 3/16	17 3/16	6 3/8	15 3/16	0.315			
50PSF2.75S ★	1	9.2	4.6	3600	2	9 5/16	6 3/8	14 15/16	17 3/16	6 3/8	16	0.315			
PSF Series	Three Phase Model	Motor Output (HP)	Rated Current (A)				*S.S. (RPM)	Discharge Size (in.)	Dimensions (in.)						Max. Solids Dia. (in.)
			208V	220V	460V	575V			Free Standing Models			TOK Guide Rail Models			
			A	B	C	D			E	F					
50PSF2.25 ★	1/3	1.65	1.6	0.75	---	3600	2	9 5/16	6 3/8	13 3/4	17 3/16	6 3/8	14 3/4	0.315	
50PSF2.4 ★	1/2	2.1	2.0	0.95	---	3600	2	9 5/16	6 3/8	14 3/16	17 3/16	6 3/8	15 3/16	0.315	
50PSF2.75 ★	1	3.2	3.2	1.5	---	3600	2	9 5/16	6 3/8	14 3/4	17 3/16	6 3/8	15 3/4	0.315	
80PSF21.5	2	6.9	6.6	*3.6	---	3600	3	11 5/8	7 11/16	17 1/8	20 11/16	7 11/16	19 5/16	0.512	
80PSF22.2	3	9.1	8.5	4.2	3.3	3600	3	12 1/4	8 3/8	22	21 5/16	8 3/8	23 3/8	0.512	
80PSF23.7	5	14.4	13.4	6.5	5.0	3600	3	12 1/4	8 3/8	23 3/8	21 5/16	8 3/8	24 3/4	0.512	

\*440V

Dimension: Free Standing (PUF2.15S, OMA4)

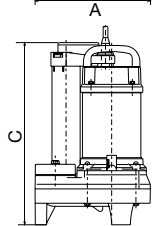
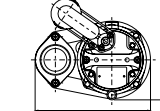

PU Series	Single Phase Model	Motor Output (HP)	Rated Current (A)				*S.S. (RPM)	Discharge Size (in.)	Dimensions (in.)						Max. Solids Dia. (in.)
			115V	230V	Free Standing Models				TOK Guide Rail Models						
			A	B	C	D			E	F					
50PU2.15S ★	1/5	3.2	1.6	3600	2	8 7/8	6 1/16	14 13/16	16 13/16	6 1/16	16 1/8	1.38			
50PU2.25S ★	1/3	4.6	2.3	3600	2	9 5/16	6 3/8	14 3/16	17 3/16	6 3/8	15 3/16	1.38			
50PU2.4S ★	1/2	5.8	2.9	3600	2	9 5/16	6 3/8	14 3/16	17 3/16	6 3/8	15 3/16	1.38			
50PU2.75S ★	1	9.2	4.6	3600	2	9 5/16	6 3/8	14 15/16	17 3/16	6 3/8	16	1.38			
PU Series	Three Phase Model	Motor Output (HP)	Rated Current (A)				*S.S. (RPM)	Discharge Size (in.)	Dimensions (in.)						Max. Solids Dia. (in.)
			208V	220V	460V	575V			Free Standing Models			TOK Guide Rail Models			
			A	B	C	D			E	F					
50PU2.25 ★	1/3	1.65	1.6	0.75	---	3600	2	9 5/16	6 3/8	13 3/4	17 3/16	6 3/8	14 3/4	1.38	
50PU2.4 ★	1/2	2.1	2.0	0.95	---	3600	2	9 5/16	6 3/8	14 3/16	17 3/16	6 3/8	15 3/16	1.38	
50PU2.75 ★	1	3.2	3.2	1.5	---	3600	2	9 5/16	6 3/8	14 3/4	17 3/16	6 3/8	15 3/4	1.38	
80PU21.5	2	6.9	6.6	*3.6	---	3600	3	11 5/8	7 11/16	18 11/16	20 11/16	7 11/16	19 5/16	1.81	
80PU22.2	3	9.1	8.5	4.2	3.3	3600	3	12 1/4	8 3/8	22 15/16	21 5/16	8 3/8	23 3/8	1.81	
80PU23.7	5	14.4	13.4	6.5	5.0	3600	3	12 1/4	8 3/8	24 5/16	21 5/16	8 3/8	24 3/4	1.81	

\*440V

Dimension: Guide Rail Fitting TOK (PU, PN, PSF, TM Series)

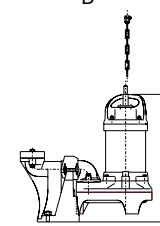
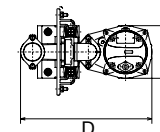

TM Series	Single Phase Model	Motor Output (HP)	Rated Current (A)				*S.S. (RPM)	Discharge Size (in.)	Dimensions (in.)						Max. Solids Dia. (in.)
			115V	230V	Free Standing Models				TOK Guide Rail Models						
			A	B	C	D			E	F					
50TM2.25S ★	1/3	4.6	2.3	3600	2	9 5/16	6 3/8	14 3/16	N/A	N/A	N/A	0.394			
50TM2.4S ★	1/2	5.8	2.9	3600	2	9 5/16	6 3/8	14 3/16	N/A	N/A	N/A	0.394			
50TM2.75S ★	1	9.2	4.6	3600	2	9 5/16	6 3/8	14 15/16	N/A	N/A	N/A	0.394			
TM Series	Three Phase Model	Motor Output (HP)	Rated Current (A)				*S.S. (RPM)	Discharge Size (in.)	Dimensions (in.)						Max. Solids Dia. (in.)
			208V	220V	460V	575V			Free Standing Models			TOK Guide Rail Models			
			A	B	C	D			E	F					
50TM2.25 ★	1/3	1.65	1.6	0.75	---	3600	2	9 5/16	6 3/8	13 3/4	N/A	N/A	N/A	0.394	
50TM2.4 ★	1/2	2.1	2.0	0.95	---	3600	2	9 5/16	6 3/8	14 3/16	N/A	N/A	N/A	0.394	
50TM2.75 ★	1	3.2	3.2	1.5	---	3600	2	9 5/16	6 3/8	14 3/4	N/A	N/A	N/A	0.394	
80TM21.5	2	6.9	6.6	*3.6	---	3600	3	11 5/8	7 11/16	17 1/8	N/A	N/A	N/A	0.787	
80TM22.2	3	9.1	8.5	4.2	3.3	3600	3	12 1/4	8 3/8	22	N/A	N/A	N/A	0.787	
80TM23.7	5	14.4	13.4	6.5	5.0	3600	3	12 1/4	8 3/8	23 3/8	N/A	N/A	N/A	0.787	

\*440V

## CONTROL PANELS & MOISTURE DETECTOR

### ■ TS SERIES CONTROL PANELS



- Lockable – 4X Enclosures
- HOA Switch – Heavy Duty Oil Tight
- Terminal Block – For Field Wiring
- Pump Run Indicator – Heavy Duty Oil Tight
- Multi-Tap Control Transformer 208 / 230 / 460 VAC Operation
- Control Alarm Fuse
- Motor Protective Switch
- Adjustable Overload Protection
- IEC Rated Magnetic Contactor
- Horn Silence Switch – Heavy Duty Oil Tight
- Auto Reset Horn Silence
- Buzzer – 95db warble
- Red Alarm Beacon
- Includes three (3) Mechanical Float Switches & Pipe Clamp

### ■ SEAL MOISTURE PROBE

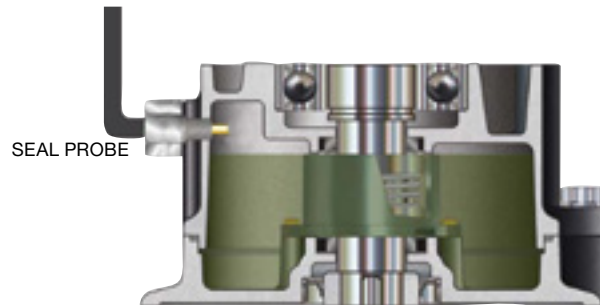

The **TSMP SEAL MOISTURE PROBE** is designed to detect moisture in the mechanical seal chamber, alerting customers of potential motor failure. The TSMP SEAL MOISTURE PROBE can be field installed on any new or existing Tsurumi pump models and connected to the control panel for the appropriate alarm or notification.

#### Principle of Operation:

- Sensor is installed through the oil port and directly into the mechanical seal chamber which contains an electrically non-conductive oil.
- The presence of water changes the chamber fluid mixture to a conductive condition and therefore completes the circuit which will result in a leakage indication on the control panel.

#### Electrical Specification

Sensor Type:	Conductive
Suggested Seal Fail Relay Voltage:	24 VAC
Required Wiring:	Single wire in separate sensor cable to be connected to seal leak relay in control panel by customer.

 **TSURUMI PUMP™**  
**BUILT FOR WORK®**

TSURUMI (AMERICA), INC.  
 Headquarters: 1625 Fullerton Ct, Glendale Heights, IL 60139  
 Utah Office: 3822 West 1987 South, Salt Lake City, UT 84104  
 Tel: 1-888-878-7864 (Toll-Free) • 1-630-793-0127  
 Fax: 1-630-793-0146 • [www.tsurumipump.com](http://www.tsurumipump.com)



Your Dealer



Find us @[tsurumiamerica](https://www.instagram.com/tsurumiamerica)