



ANDERSON
PROCESS

Corporate
Capabilities

Since
1958

Anderson Process has been the Midwest's trusted supplier of fluid process equipment and reliable, value-added service.

Originally founded as A.A. Anderson, a distributor of industry-leading pumping equipment, Anderson Process has evolved to become a single-source partner dedicated to enhancing the profitability of your fluid-handling processes. Whether it be through equipment, aftermarket services or expert-driven consultation, our mission is to ensure that our clients transfer their critical fluids in the safest, most efficient and effective manner.

Our **MISSION**

Enhancing the profitability of each of our customers by providing expert-driven equipment integration and services that increase production output, reduce maintenance costs and drive operational efficiency.

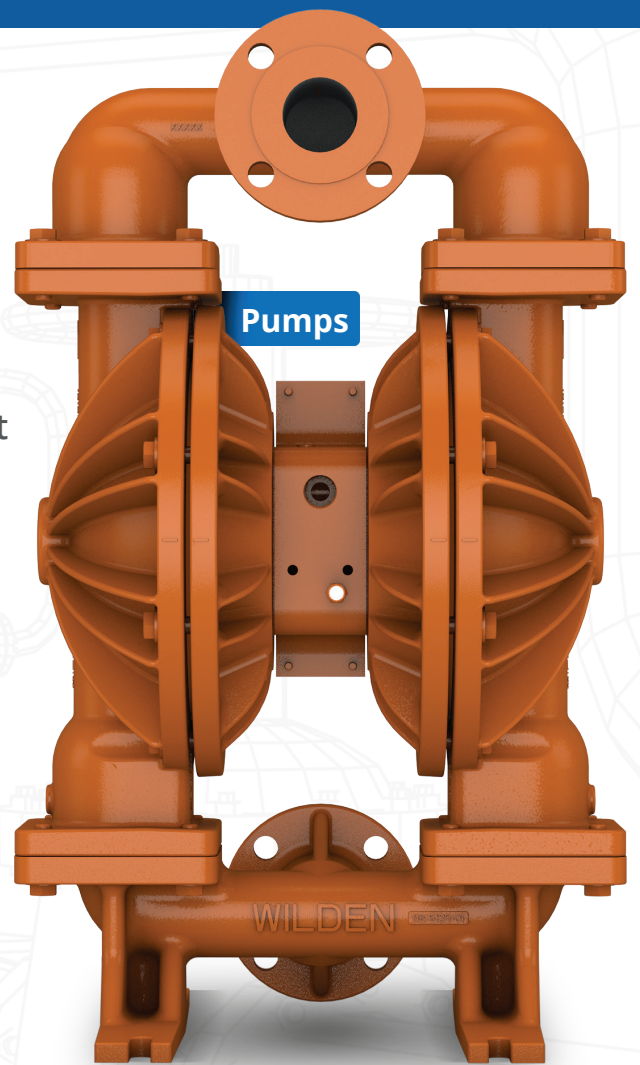

MARKETS SERVED



Automotive

Chemical

Food & Beverage

General Industrial

The **ANDERSON DIFFERENCE**

Determined to Earn It - The Anderson Way
Integrity. Trust. Experience. Knowledge.

Through close collaboration with our customers, we strive to add value in ways that simple warehouse suppliers can't. We offer what you'd expect from a distributor, but with the added ability to consult, design, and build complex systems to meet unique requirements.



Expertise You Can Trust

- 140+ Process Equipment Professionals
- Application and Systems Engineers
- Dedicated Product Managers and Support Staff
- Comprehensive Process Equipment Experience and Knowledge
- Customer-Driven Integrated Solutions Approach
- Committed to the Profitability of our Clients



Technology to Serve You Better

- Streamlined Ordering Through E-commerce
- Electronic Data Interchange (EDI) Capabilities
- Order Tracking and Inventory Management
- RFID-Driven Automated Tracking Systems
- Comprehensive Invoice and Quoting Systems
- 2D/3D CAD Modeling Services



Streamlining Your Process

- Integrated Solutions Across All Process Equipment Categories
- One Source Supplier for Your Process Needs
- Product Recommendations that:
 - Reduce downtime
 - Drive yield output
 - Lower maintenance costs
 - Increase Mean Time Between Failures (MTBFs)
 - Enhance profitability

"The reason we went with Blackmer and Wilden was our partnership with Anderson. Another reason for choosing them was the way they have handled and stood behind their products. That has made them a partner forever."

- A Chemical Manufacturer



Paints & Resins



Power Generation



Pulp & Paper



Water & Wastewater

INTEGRATED PROCESS SOLUTIONS

At Anderson, our approach to service and support makes us true “solutions integrators” in every sense of the words. Through hands-on, direct collaboration, our team works closely with each of our customers to come to a 360-degree understanding of your fluid-handling process. Once this is achieved, we leverage our expertise to recommend the best equipment and system integration to optimize your processes and increase plant profitability.

PUMPS

The pump is the heart
of any fluid movement.

Proper pump selection is critical to maximizing the output of your operation. Anderson’s in-house pump experts will ensure that the pump we specify will be the ideal type and size, and configured to meet the needs of even the harshest and most demanding process applications.



VACUUM PUMPS & BLOWERS

Find the optimum vacuum or blower
for any application.

A vacuum pump is a device that creates a negative pressure condition by removing gas molecules or air particles from a sealed volume. A blower does just the opposite, creating a positive pressure condition by introducing gas molecules or air particles to a sealed volume. When designing or operating a vacuum or blower system, it is critical to understand all variables of an application. Let us help you pick the proper style and technology of equipment for your process to ensure optimum productivity.



FLUID SEALING

Reliable sealing
for any fluid process application.

Not all seals are created equal; unique industrial process applications require specialized sealing technology. Ineffective sealing in an industrial process operation can lead to catastrophic failures and untold revenue losses resulting from unexpected shut-downs. Finding the correct sealing method minimizes unnecessary resource consumption, and can greatly reduce overall process efficiency and safety.

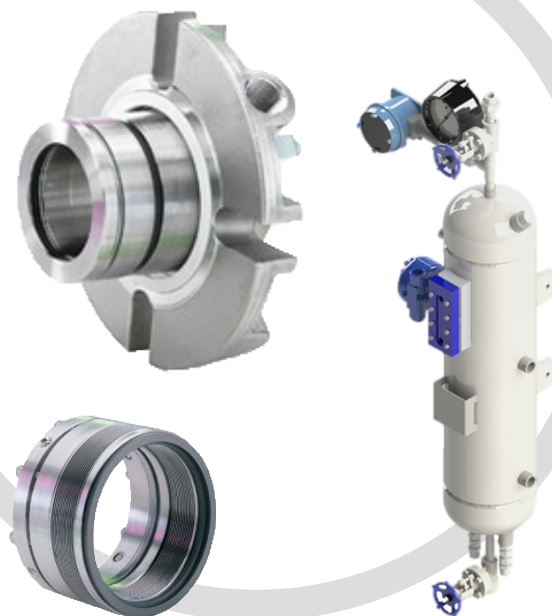

HEAT EXCHANGERS

Process temperature management
presents a complex logistics challenge.

Properly managing material temperatures is critical to overall process efficiency and maintaining a consistent product quality. The selection and integration of a heat exchanger is one of the most effective ways to transfer the energy utilized for heating and cooling, and reduce operational expenses. The heat exchangers we carry have been engineered with consistent, long-term performance in mind.

Standard **Xchange**
a xylem brand

THERMALINE



MIXERS

Improperly mixed materials
cause product loss & inefficient production.

Ineffective mixing can lead to inconsistent quality, product loss or even missed deliveries. Our mixers, supplied by two of the industry's leading mixer manufacturers, provide reliable mixing, minimal maintenance and maximum uptime.

Ampco Pumps Company



Hayward Gordon

Sharpe Mixers
A Hayward Gordon Company

MixMOR



GENERAL PROCESS EQUIPMENT

The equipment you need
for everything else.

We offer Valves, Gauges, Gearboxes, Motors, Couplings, Pulsation Dampeners, Flow Meters, Instrumentation and much more.

**BALDOR
RELIANCE**



BLACOHTM
FLUID CONTROL



Endress+Hauser
People for Process Automation

Fulflo



DRIVESYSTEMS



FLUID FILL SYSTEMS

Semi-automated systems
for a range of fluids and flow rates.

We engineer, design and build automated systems to dispense hazardous and non-hazardous fluids in an assembly line setting in a myriad of industries. We have experience with pressure fill systems used to fill Gas, Diesel, DEF fluids, Windshield Wiper Fluid and Oils. In addition, we work with fluids such as Refrigerant and Brake Lines, which require pulling a vacuum and evacuating a line before the fill process. These projects often start with standard systems and then are engineered to order, accommodating variances in automation, size, scope and equipment type. Commissioning and start-up and services such as leak and vacuum testing are also offered.

AD ANDERSON
PROCESS



FILTRATION

Poorly filtered fluids are one of the leading causes
of premature wear and failure.

Improper filter selection is one of the primary sources of product contamination and process consistency issues. Our filtration offerings, including replacement schedule and maintenance assistance, help ensure that your equipment can achieve maximum life and uptime.



HOSE & FITTINGS

Each and every hose
has its own ideal application.

Using the incorrect hose is dangerous to both your people and your profits. Our line of NAHAD-certified hose assemblies, combined with our reconditioning and maintenance-tracking services, keep your operation running safely and reliably at all times.



We've tested over 10,000 hoses in dozens of facilities. **THE AVERAGE FAILURE RATE IS 18%**
Improve Safety and Reduce Unforeseen Downtime with our Hose Audit Programs.



Traceable Data



Efficient Testing



Mobile & Convenient

SERVICE & REPAIR

Equipment service and repair
designed with uptime in mind.

With decades of experience in the rotating equipment market and a robust inventory of OEM parts at our disposal, Anderson Process is uniquely positioned to deliver superior refurbishment and aftermarket services for even the most complex liquid process equipment. As an Authorized Service Center for many of the industrial market's top rotating equipment manufacturers, our technicians provide the expert, hands-on service needed to get equipment back on-line quickly and to keep your fluid process operation running as efficiently as possible for as long as possible.

Authorized Service Center

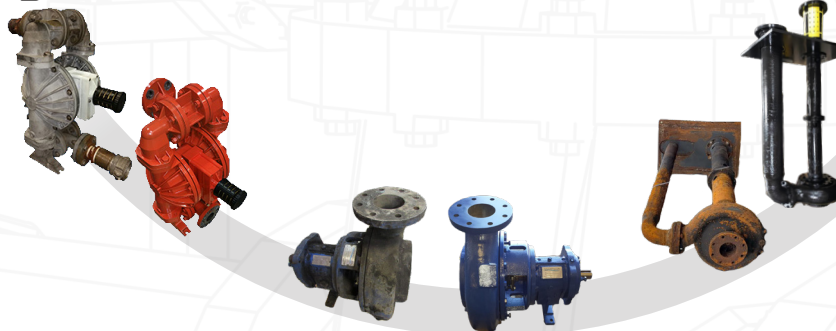

REPAIR SERVICES

- ▶ Comprehensive Inspection
- ▶ OEM Repair & Rebuild
- ▶ Bearing Replacement
- ▶ Heat Exchanger Refurbishment
- ▶ Impeller Trimming & Balancing
- ▶ Machining & Fabrication
- ▶ Mechanical Seal Repair & Upgrades
- ▶ Sanitary Pump Re-manufacturing
- ▶ Meter Calibration
- ▶ Motor Testing
- ▶ Root Cause Analysis
- ▶ Sandblasting & Painting
- ▶ Shaft Alignment & Refurbishment
- ▶ Skid System Refurbishment
- ▶ Hydrostatic Testing
- ▶ Run testing up to 100 HP

FIELD SERVICES

- ▶ Laser Alignment
- ▶ Meter Calibration
- ▶ On-Site Repair
- ▶ Replacements & Retrofits
- ▶ Root Cause Analysis
- ▶ Start-up & Training
- ▶ Troubleshooting
- ▶ Vibration Analysis

EXCHANGE PROGRAMS

- ▶ API Pump Gearboxes
- ▶ ANSI Pump Power Ends
- ▶ Blowers
- ▶ Mechanical Seals
- ▶ Sanitary Circumferential Piston Pumps
- ▶ Shaft Assemblies
- ▶ Vacuum Pumps

PLANNED MAINTENANCE & AUDITS

- ▶ Equipment Surveys
- ▶ Flow Measurement
- ▶ Laser Alignments
- ▶ Oil & Filter Changes
- ▶ Oil Analysis
- ▶ System Upgrades
- ▶ Troubleshooting
- ▶ Vibration Analysis

VALUE-ADDED SERVICES

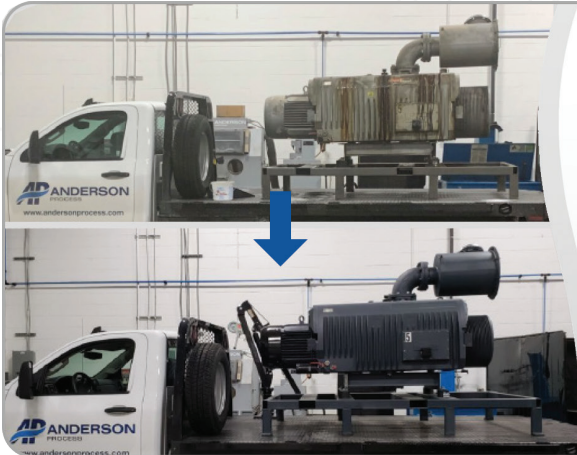

Aftermarket Service and Repair

As an Authorized Service Center for many of our brands, we provide the hands-on service required to keep your equipment running as long as possible, and reduce spend while increasing process uptime.



Commissioning and Start-Up Services

Getting a fluid process operation up and running is a complex procedure that requires specialized knowledge in various equipment categories. Our versatile staff of fluid process experts ensures that you can consistently achieve optimal production and performance from the moment you're ready to run.

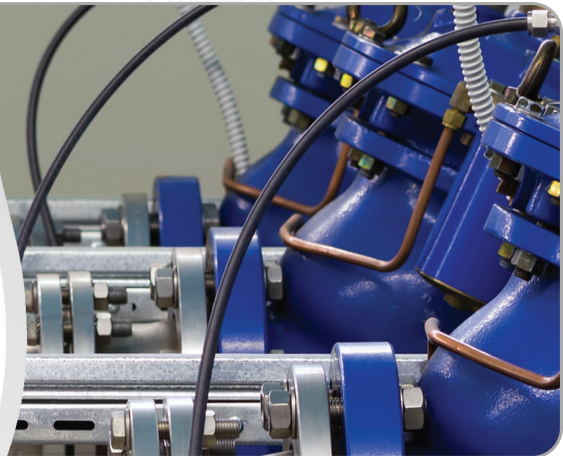

Custom-Built Control Panel Systems

Our control panels are built to UL508A specifications and deliver complete functionality regarding the needs of the user and system. They are easy to use, increase productivity, reduce waste, and increase efficiency. Every panel is tested and guaranteed as a turn-key solution, with on-site start-up and commission services available.



Custom-Engineered Skids and Fabrication

Our team of engineers and technicians work together to develop standalone or integrated skids and systems that can help meet your unique fluid process challenges. We have the ability consult, design & engineer, build, test, install and start-up custom skids & systems to fit seamlessly into any fluid-process environment.



Adding Value Through Integrated Service Solutions.

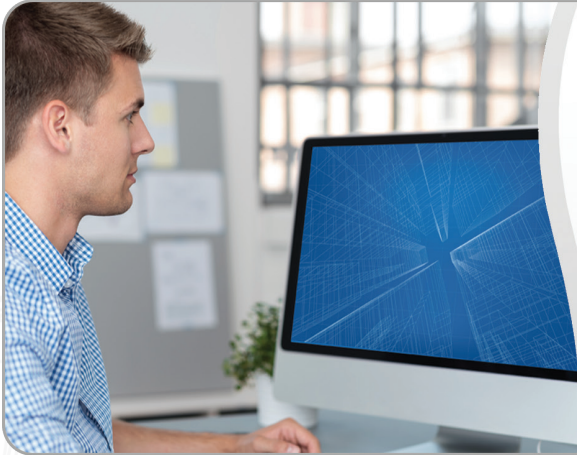

Engineering/CAD Drawing Support

An in-house staff of engineers allows us to offer custom-designed process systems that will result in optimized production, driven by practical, cost-effective product specifications and configurations.



Hose Tracking and Testing

Proper hose maintenance is critical to maintaining a safe and compliant work environment. Leveraging powerful RFID technology, we offer tracking services that provide complete hose assembly information and visibility over ideal service intervals. All hose assemblies are manufactured and tested to NAHAD specifications.



Inventory Management

With a comprehensive ERP system that provides real-time access to inventory, order history, and purchasing trends, we have the tools necessary to make your procurement and stocking procedures simple. We can also design an inventory or consignment program to meet your specific needs.



Training and Certification Programs

Our team of experienced process professionals has developed accessible training and safety certification programs designed to prepare your team for maintaining a safe and compliant work environment.



Our full LINE CARD

Pump Manufacturers

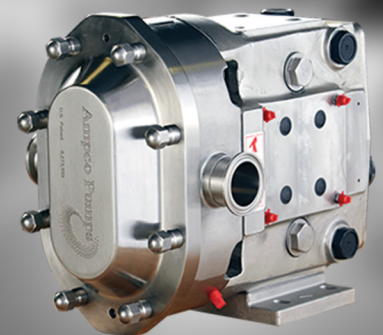

Process

BALDOR • RELIANCE™



Endress+Hauser
People for Process Automation



THERMALINE



Filtration



Hose & Fittings



Packaged Skids, Systems

Integrated Systems
OEM Sub-Assemblies
Procurement
Pump System Design

Value-Added Services

Aftermarket Service and Repair
Commissioning and Start-Up Services
Custom-Built Control Panel Systems
Custom-Engineered Skids and Fabrication
Engineering/CAD Drawing Support
Hose Tracking and Testing
Inventory Management
Training and Certification Programs

Factory Authorized Service Center

Ampco
Atlas Copco
Blackmer
Griswold
Gusher

Hayward Gordon
Sundyne
Thomas Pump
Wilden
Xylem

*Not all products available in all locations

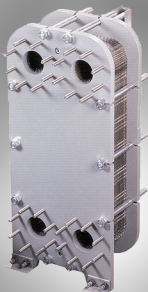



Leverage our experience & expertise to enhance the profitability of your fluid processes.

We Keep Your Business Flowing

Wisconsin Corporate
21365 Gateway Court
Brookfield, WI 53045
(262) 784-3340

Illinois Branch
960 Oak Creek Drive
Lombard, IL 60148
(630) 782-6834

Indiana Branch
8104 Woodland Drive
Indianapolis, IN 46278
(317) 875-6900

Michigan Branch
41304 Concept Drive
Plymouth, MI 48170
(248) 476-7782

Ohio Branch
4891 Van Epps Road
Brooklyn Heights, OH 44131
(216) 739-1600

AndersonProcess.com · Sales@AndersonProcess.com

Serving Illinois, Indiana, Iowa, Kentucky, Michigan, Ohio and Wisconsin