

3642/3742

REPAIR PARTS

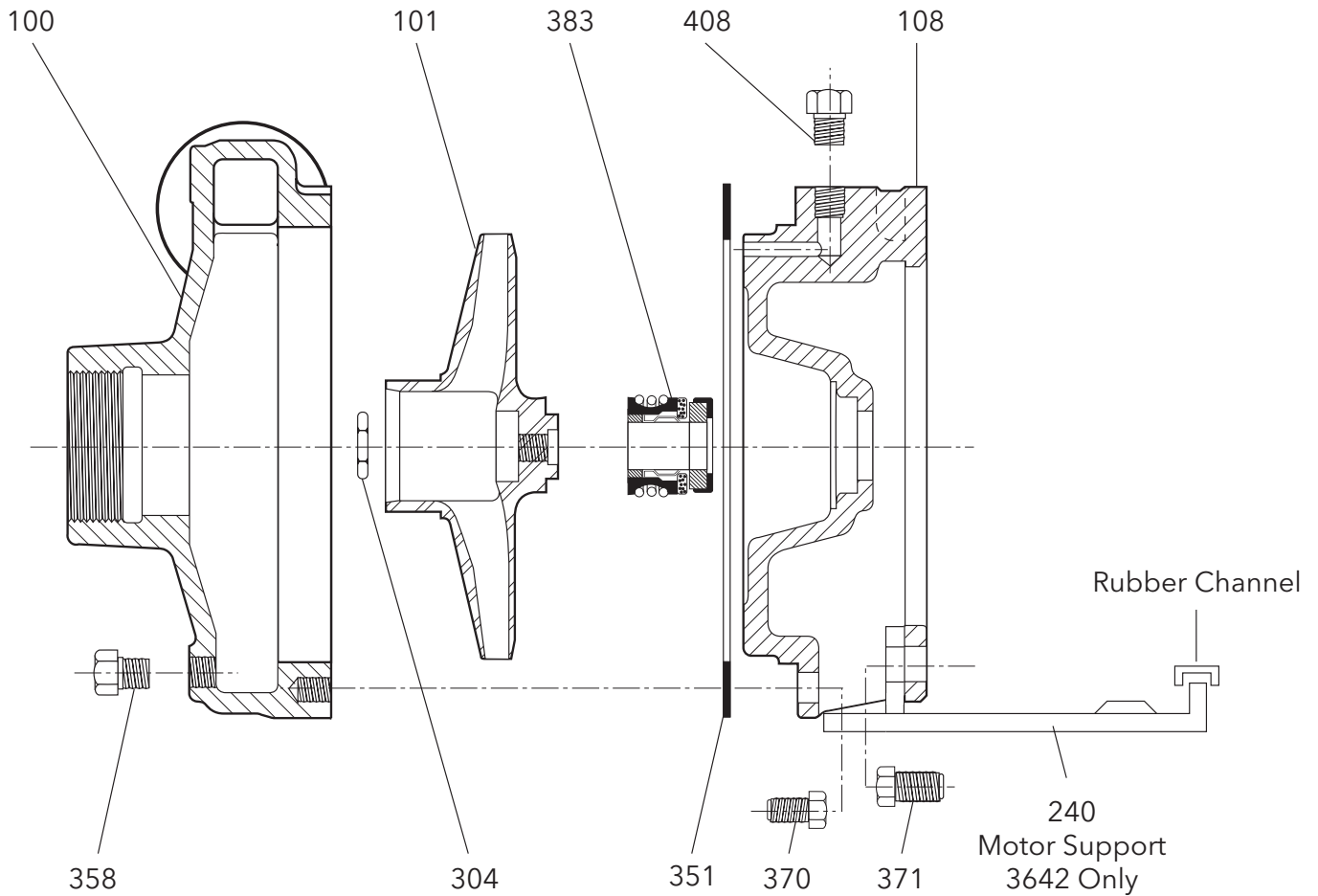

For XS-Group power frame individual parts,
see XS-Group power frame repair parts page.

REPLACEMENT PARTS LISTING		PART ORDER NO.					
Item No.	Description	Material					
		Bronze Fitted		All Iron		All Bronze	
		Pump Size					
		1BF	2BF	1AI	2AI	1AB	2AB
100	Casing with plug	1K70	1K73	1K70	1K73	1K72	1K75
101	Impeller diameter - 5 $\frac{3}{8}$ "	2K36	2K920	2K75	2K90	2K36	2K920
	5 $\frac{1}{8}$ "	2K37	-	2K76	-	2K37	-
	5"	-	2K921	-	2K91	-	2K921
	4 $\frac{7}{16}$ "	2K38	-	2K77	-	2K38	-
	4 $\frac{3}{8}$ "	-	2K922	-	2K92	-	2K922
	3 $\frac{7}{8}$ "	2K39	2K923	2K78	2K93	2K39	2K923
	3 $\frac{5}{8}$ "	-	2K924	-	2K94	-	2K924
	3 $\frac{3}{16}$ "	2K40	-	2K79	-	2K40	-
	3 $\frac{1}{16}$ "	2K41	-	2K80	-	2K41	-
	3 $\frac{1}{8}$ "	-	2K925	-	2K95	-	2K925
	2 $\frac{1}{8}$ "	-	2K926	-	2K96	-	2K926
108	Frame adapter	1K265			1K266		
240	Motor Support	4K520					
	Rubber Channel						
304	Impeller locknut - three phase only	13K286					
351	Casing gasket	5K115					
358	Drain plug	6K1					
370	Hex head screws - casing	13K108					
371	Hex head screws - adapter	13K179					
383	Mechanical Seal						
	Carbon/ceramic/BUNA	10K10					
	Carbon/Ni-resist/BUNA	10K6					
	Carbon/sil-car/EPR	10K18					
	Carbon/sil-car/viton	10K55					
408	Prime plug	6K2					

* Lubrication of socket head screw is recommended to avoid galling of stainless steel parts.

MOTOR REFERENCE CHART (for 3642 only)

Motor RPM	NEMA Standard 56J Flange	Single Phase		Three Phase	
		ODP	TEFC	ODP	TEFC
1/2 HP		E04853S	E04821	E04873S	E04876
3/4 HP		E05853S	E05821	E05873S	E05876
1 HP		E06853S	E06821	E06873S	E06876
1 1/2 HP		E07858S	E07821	E07878S	E07876
2 HP		E08854S	E08821	E08874S	E08876
3 HP		E09854S	E09821	E09874S	E09876

NOTE: For motor pricing see end suction price booklet. For complete power frame assembly use part no. 14L61.

1AI, 1BF, 1AB = 1 x 1 $\frac{1}{4}$ - 5
 2AI, 2BF, 2AB = 1 $\frac{1}{4}$ x 1 $\frac{1}{2}$ - 5

Xylem Inc.

2881 East Bayard Street Ext., Suite A, Seneca Falls, NY 13148

Phone: (800) 453-6777 Fax: (888) 322-5877

www.gouldswatertechnology.com

