

<b>Threaded Pipe Fittings ..... J-2 to J-28</b>	<b>Pipe Couplings ..... J-34, J-35</b>
NPT threaded bell reducers..... J-2, J-3	Strab Grip-L..... J-34
Adapters ..... J-3	Straub Open-Flex ..... J-35
NPT threaded couplings - both ends ..... J-4	<b>Flanges &amp; Flange Adapters .J-36, J-37</b>
Merchant couplings ..... J-4	150 lb. ASA..... J-36, J-37
Threaded unions..... J-5	King™ turned back weld-to-metal hose nipples ..... J-37
NPT threaded reducing union..... J-5	<b>Grooved Fittings ..... J-38 to J-50</b>
Hex couplings ..... J-5	Quick release..... J-38
Reducer hex bushings..... J-6, J-7	Standard couplings..... J-39
Adapters ..... J-7	Lightweight flexible ..... J-40
Nipples..... J-8 to J-11	Lite® couplings ..... J-41
Pipe..... J-8, J-9	Rigid couplings ..... J-42
Adapters..... J-8	Bolted clamps ..... J-43
Close..... J-9, J-10	Painted iron clamps with Baylast™ gaskets..... J-43
Hex..... J-10	Mechanical tees..... J-44
Adapters..... J-11	Flange adapters..... J-45
90° Elbows ..... J-12 to J-14	ANSI split flange..... J-45
NPT threaded..... J-12	Reducing adapters ..... J-45
Female pipe ..... J-12	End fittings..... J-46
NPT threaded reducing..... J-13	Caps ..... J-47
Street ..... J-13	Nipples..... J-47
NPT threaded street..... J-14	Butterfly valves ..... J-47
45° Elbows ..... J-15	Gaskets ..... J-48
Tees ..... J-16 to J-18	Accessories ..... J-49
NPT threaded female..... J-16	High density polyethylene couplings ..... J-50
Female extruded ..... J-16	<b>Line Strainers ..... J-51</b>
Reducing..... J-17	Y line..... J-51
Street service..... J-17	Polypropylene T line ..... J-51
Bull head ..... J-17	<b>LP Gas Fittings..... J-52 to J-54</b>
Side outlet..... J-17	Adapters ..... J-52
Street ..... J-18	Couplings..... J-53
Male branch ..... J-18	Gaskets ..... J-53
Crosses ..... J-18	Spanner wrench ..... J-53
Caps ..... J-19	Caps and plugs..... J-54
Plugs..... J-20	<b>Tubing Fittings ..... J-55 to J-78</b>
Schedule 80 plastic fittings..... J-21 to J-24	Instrumentation..... J-55 to J-58
Tuff-Lite™ plastic fittings ..... J-21 to J-24	Compression ..... J-59 to J-64
Bulkhead..... J-25	Brass SAE 45° flare..... J-65 to J-67
Bolted fittings..... J-26	Flareless bite ..... J-68 to J-70
Swage nipples ..... J-27	Sharkbite® push to connect ..... J-71 to J-72
Bull plugs..... J-28	LIQUIfit™ ..... J-73 to J-76
<b>Hammer Unions ..... J-29 to J-31</b>	TrueSeal™ ball valves..... J-77 to J-78
Series 100, 200, 206, 400, 602, 1002, 1502 ..... J-29 to J-31	
Hookie hook lifters ..... J-31	
<b>Weld to Metal Hose Fittings ..... J-32</b>	
<b>Wrench Grips..... J-33</b>	

**Fire Adapters & Connections ..... J-79 to J-129**

Double female hex adapters..... J-79

Female rocker lug - suction with poly screen ..... J-79

Female swivel adapters..... J-80

    Pin lug..... J-80

    Rocker lug..... J-80

Double female swivels with pin lugs ..... J-81

Aluminum female swivels with rocker lug..... J-82, J-83

Aluminum double female swivels with long handle ..... J-83

Hydrant adapters..... J-84 to J-87

    Pin lugs ..... J-84, J-86, J-87

    Rocker lugs..... J-85, J-87

    Long handle ..... J-85

Hazmat with pin lugs ..... J-86

Hex nipples..... J-87 to J-89

Single male outlet with hex..... J-88

Female x male with rocker lug..... J-90 to J-91

Brass female swivel to male ..... J-92

    Pin lugs ..... J-92

    Rocker lugs..... J-92

Male rocker lug - suction ..... J-93

Female swivel to male with rocker lug..... J-94

Female swivel to male with long handle..... J-94

Double male hex nipple ..... J-95 to J-96

Double male with pin and rocker lug ..... J-97

Double male with rocker lugs ..... J-98

Cam & groove hydrant adapters..... J-99

Caps ..... J-100 to J-104

    Brass with pin and rocker lugs..... J-100

    Brass test..... J-100

    Aluminum rocker lug and long handle with cable..... J-101

    Aluminum test ..... J-101

    Thermoplastic ..... J-102

    Breakable..... J-103

    Specialty ..... J-104

Plugs..... J-104, J-105

    FDC..... J-104

    Adjust-A-Plug..... J-104

    Brass with pin and rocker lug..... J-105

Brass replacement swivels and accessories..... J-106

Storz ..... J-107 to J-112

    Rigid female..... J-107

    Female swivel with rocker lug and long handle ..... J-108

    Rigid male ..... J-109

    Female swivel 30° elbow ..... J-110

    150 lbs. flange..... J-110

    Storz x storz..... J-111

    Accessories..... J-112

**Fire Adapters & Connections (cont.) . J-79 to J-129**

Wrenches ..... J-113 to J-116

Long handle short shank suction hose females ..... J-117

Angle and suction elbows..... J-117

Continuous swivel elbows ..... J-117

Pump test headers ..... J-118

Hydrant diffusers ..... J-118

Roof connections..... J-119 to J-121

    Two way male outlet ..... J-119 to J-120

    Three way male outlet..... J-121

Sleeve for sidewalk connections ..... J-121

Identification plates..... J-122

British instantaneous ..... J-123 to J-124

International shore connections..... J-125

Dry hydrants ..... J-126

Strainers ..... J-127 to J-131

    Low level with siphon jet..... J-127

    Barrel and basket..... J-128

    Floating ..... J-129

    Tank round hole ..... J-129

**Sanitary Tube Fittings ..... J-130 to J-195**

Clamps ..... J-130 to J-132

Clamp accessories ..... J-132

Clamp fittings..... J-133 to J-141

    Ferrules..... J-133, J-134

    Caps..... J-135

    Adapters..... J-135 to J-138

    Elbows ..... J-138, J-139

    Tees ..... J-140

    Reducers..... J-141

    Crosses..... J-141

    Miscellaneous configurations..... J-142

    Covers..... J-142

    Quick weld ferrules ..... J-143

    Breakaway couplings..... J-143

    Gaskets..... J-144 to J-149

Cam and groove transition ..... J-150

Dixon® weld to tube cam and groove..... J-150

European fittings..... J-151 to J-154

    Bevel seat..... J-155 to J-159

        Hex nuts..... J-155

        Hex wrenches ..... J-155

        Ferrules..... J-156, J-157

End caps..... J-157

    Adapters..... J-157

    Elbows ..... J-158

    Reducers..... J-158

    Breakaway couplings..... J-158

    Gaskets..... J-159

Sanitary Tube Fittings (cont.) ..... J-130 to J-195

I-line / Q-line ..... J-160 to J-164

    Clamps..... J-160

    Ferrules..... J-161, J-162

    End caps..... J-162

    Gaskets..... J-163, J-164

Pipe size ..... J-165 to J-168

    Clamps..... J-165

    Ferrules..... J-165, J-166

    End caps..... J-166

    Adapters..... J-167

    Hangers ..... J-168

    Gaskets..... J-169

Polished weld ..... J-170 to J-176

    Elbows ..... J-171, J-172

    Sweep elbows..... J-172

    Tees ..... J-173

    Adapters..... J-174

    Reducers..... J-174

    Crosses..... J-175

    Miscellaneous configurations..... J-175

Unpolished weld ..... J-176 to J-180

    Elbows ..... J-176, J-177

    End caps..... J-177

    Adapters..... J-177

    Tees ..... J-178

    Reducers..... J-179

    Type A stub ends..... J-179

    Miscellaneous configurations..... J-180

    Flanges ..... J-181

Spray balls..... J-182

Sight glasses ..... J-183

Compact sight glasses ..... J-184

Swivels ..... J-185

Pressure gauges ..... J-186

Strainers ..... J-187, J-188

Tube Hangers..... J-189, J-190

Wall Flanges..... J-190

High Purity Biopharm fittings ..... J-191 to J-196

Technical Information..... J-197

NPT Threaded Bell Reducers

Features:

- other sizes available
- 304 stainless steel fittings are also available, consult Dixon® for pricing and availability



300# iron



150# iron



150# galvanized iron

Female NPT	Female NPT	300# Iron		150# Iron		150# Galvanized Iron	
		Part #	Price/E	Part #	Price/E	Part #	Price/E
1/4"	1/8"	---	---	<b>BR1418</b>	<b>\$4.05</b>	---	---
3/8"	1/8"	---	---	<b>BR3818</b>	<b>4.05</b>	---	---
	1/4"	---	---	<b>BR3825</b>	<b>4.05</b>	---	---
1/2"	1/4"	<b>300BR5025</b>	<b>\$25.15</b>	<b>BR5025</b>	<b>3.70</b>	<b>BR5025G</b>	<b>\$4.60</b>
	3/8"	---	---	<b>BR5038</b>	<b>3.50</b>	<b>BR5038G</b>	<b>4.30</b>
3/4"	1/4"	---	---	<b>BR7525</b>	<b>4.60</b>	---	---
	3/8"	---	---	<b>BR7538</b>	<b>4.60</b>	---	---
	1/2"	<b>300BR7550</b>	<b>25.70</b>	<b>BR7550</b>	<b>4.00</b>	<b>BR7550G</b>	<b>5.00</b>
1"	1/4"	---	---	<b>BR1025</b>	<b>7.10</b>	---	---
	3/8"	---	---	<b>BR1038</b>	<b>7.20</b>	---	---
	1/2"	---	---	<b>BR1050</b>	<b>6.25</b>	<b>BR1050G</b>	<b>8.35</b>
1 1/4"	3/4"	<b>300BR1075</b>	<b>30.70</b>	<b>BR1075</b>	<b>6.25</b>	<b>BR1075G</b>	<b>7.75</b>
	1"	---	---	<b>BR1250</b>	<b>8.95</b>	---	---
1 1/2"	3/4"	---	---	<b>BR1275</b>	<b>7.80</b>	---	---
	1"	<b>300BR1210</b>	<b>40.35</b>	<b>BR1210</b>	<b>7.80</b>	<b>BR1210G</b>	<b>10.60</b>
	3/4"	---	---	<b>BR1575</b>	<b>12.90</b>	---	---
2"	1"	<b>300BR1510</b>	<b>55.35</b>	<b>BR1510</b>	<b>11.40</b>	<b>BR1510G</b>	<b>13.70</b>
	1 1/4"	<b>300BR1512</b>	<b>62.95</b>	<b>BR1512</b>	<b>9.85</b>	<b>BR1512G</b>	<b>12.90</b>
	3/4"	---	---	<b>BR2075</b>	<b>16.30</b>	---	---
2 1/2"	1"	<b>300BR2010</b>	<b>80.20</b>	<b>BR2010</b>	<b>15.40</b>	<b>BR2010G</b>	<b>18.60</b>
	1 1/4"	<b>300BR2012</b>	<b>94.50</b>	<b>BR2012</b>	<b>16.30</b>	---	---
	1 1/2"	<b>300BR2015</b>	<b>79.50</b>	<b>BR2015</b>	<b>14.25</b>	<b>BR2015G</b>	<b>18.65</b>
3"	1"	---	---	<b>BR2510</b>	<b>41.50</b>	---	---
	1 1/2"	---	---	<b>BR2515</b>	<b>42.40</b>	---	---
	2"	---	---	<b>BR2520</b>	<b>36.40</b>	<b>BR2520G</b>	<b>57.75</b>
	1"	---	---	<b>BR3010</b>	<b>57.75</b>	---	---
4"	1 1/4"	---	---	<b>BR3012</b>	<b>61.80</b>	---	---
	1 1/2"	---	---	<b>BR3015</b>	<b>56.50</b>	---	---
	2"	---	---	<b>BR3020</b>	<b>47.00</b>	<b>BR3020G</b>	<b>72.25</b>
	2 1/2"	---	---	<b>BR3025</b>	<b>56.50</b>	<b>BR3025G</b>	<b>76.50</b>
6"	1"	---	---	<b>BR4010</b>	<b>113.50</b>	---	---
	1 1/2"	---	---	<b>BR4015</b>	<b>114.00</b>	---	---
	2"	---	---	<b>BR4020</b>	<b>114.00</b>	---	---
	2 1/2"	---	---	<b>BR4025</b>	<b>114.00</b>	---	---
	3"	---	---	<b>BR4030</b>	<b>114.00</b>	<b>BR4030G</b>	<b>165.75</b>
6"	3"	---	---	<b>BR6030</b>	<b>285.00</b>	---	---
	4"	---	---	<b>BR6040</b>	<b>285.00</b>	---	---

• For additional information on pipe dimensions please reference [dixonvalve.com](http://dixonvalve.com).

## NPT Threaded Bell Reducers

Features:

- other sizes available
- 304 stainless steel fittings are also available, consult Dixon® for pricing and availability

Female NPT	Female NPT	150# 316 Stain.Steel		3000# Forged Steel		125# Brass	
		Part #	Price/E	Part #	Price/E	Part #	Price/E
1/4"	1/8"	---	---	---	---	---	---
3/8"	1/8"	---	---	---	---	---	---
	1/4"	<b>BR3825SS</b>	<b>\$6.80</b>	---	---	---	---
1/2"	1/4"	<b>BR5025SS</b>	<b>9.25</b>	---	---	---	---
	3/8"	<b>BR5038SS</b>	<b>8.60</b>	<b>BR5038FS</b>	<b>\$9.40</b>	<b>BR5038B<sup>1</sup></b>	<b>\$10.50</b>
3/4"	3/8"	<b>BR7538SS</b>	<b>11.85</b>	---	---	<b>3771206C</b>	<b>11.91</b>
	1/2"	<b>BR7550SS</b>	<b>11.10</b>	<b>BR7550FS</b>	<b>11.15</b>	<b>BR7550B<sup>1</sup></b>	<b>15.50</b>
1"	1/2"	<b>BR1050SS</b>	<b>16.80</b>	---	---	<b>BR1050B</b>	<b>26.00</b>
	3/4"	<b>BR1075SS</b>	<b>16.80</b>	<b>BR1075FS</b>	<b>14.60</b>	<b>BR1075B</b>	<b>25.40</b>
1 1/4"	1"	<b>BR1210SS</b>	<b>22.00</b>	---	---	<b>BR1210B</b>	<b>41.00</b>
1 1/2"	3/4"	---	---	---	---	<b>BR1575B</b>	<b>64.60</b>
	1"	<b>BR1510SS</b>	<b>29.25</b>	<b>BR1510FS</b>	<b>27.55</b>	<b>BR1510B</b>	<b>51.70</b>
2"	1 1/4"	<b>BR1512SS</b>	<b>29.25</b>	<b>BR1512FS</b>	<b>27.55</b>	---	---
	1"	<b>BR2010SS</b>	<b>49.50</b>	<b>BR2010FS</b>	<b>39.95</b>	<b>BR2010B</b>	<b>86.50</b>
2 1/2"	1 1/2"	<b>BR2015SS</b>	<b>49.95</b>	<b>BR2015FS</b>	<b>39.95</b>	<b>BR2015B</b>	<b>77.00</b>
	2"	---	---	---	---	<b>BR2520B</b>	<b>134.50</b>
3"	2"	<b>BR3020SS</b>	<b>146.00</b>	---	---	<b>BR3020B</b>	<b>180.20</b>
4"	3"	---	---	---	---	<b>BR4030B</b>	<b>428.25</b>



150# 316 stainless steel



3000# forged steel



125# brass

Pipe, Welding & Tube Fittings

<sup>1</sup> items will be discontinued as stock is depleted

## Adapters

### Reducer Couplings

Feature:

- ref SAE 130138

Female NPTF	Brass			Optional Qty	Lead Free Brass <sup>1,2,3</sup>	
	Previous Part #	Part #	Price/E		Part #	Price/E
1/4" x 1/8"	RC2F1F	<b>3770402C</b>	<b>\$4.80</b>	50	---	---
3/8" x 1/8"	RC3F1F	<b>3770602C</b>	<b>7.69</b>	50	---	---
3/8" x 1/4"	RC3F2F	<b>3770604C</b>	<b>5.34</b>	50	---	---
1/2" x 1/4"	RC4F2F	<b>3770804C</b>	<b>7.32</b>	25	---	---
1/2" x 3/8"	RC4F3F	<b>3770806C</b>	<b>7.09</b>	10	<b>3770806CLF</b>	<b>\$17.74</b>
3/4" x 3/8"	RC6F3F	<b>3771206C</b>	<b>11.91</b>	10	---	---
3/4" x 1/2"	RC6F4F	<b>3771208C</b>	<b>11.66</b>	10	<b>3771208CLF</b>	<b>23.18</b>



<sup>1</sup> lead free brass <=0.25% lead; Alloy CA2745; Alloy C46400

<sup>2</sup> conforms To: Safe Water Drinking Act (SWDA) of Jan. 4, 2014; California AB1953; RoHS Compliant

<sup>3</sup> NPT threads

• For additional information on pipe dimensions please reference dixonvalve.com.

NPT Threaded Couplings



300# iron



150# iron



150# galvanized iron



150# 316 stainless steel



3000# forged steel



125# brass

Female NPT	300# Iron		150# Iron		150# Galvanized Iron	
	Part #	Price/E	Part #	Price/E	Part #	Price/E
1/8"	---	---	<i>RHC18</i>	\$4.95	<i>RHC18G</i>	\$5.75
1/4"	<i>300RHC25</i>	\$15.80	<i>RHC25</i>	4.20	<i>RHC25G</i>	5.35
3/8"	<i>300RHC38</i>	15.80	<i>RHC38</i>	4.20	<i>RHC38G</i>	5.35
1/2"	<i>300RHC50</i>	17.65	<i>RHC50</i>	3.40	<i>RHC50G</i>	4.30
3/4"	<i>300RHC75</i>	20.25	<i>RHC75</i>	4.00	<i>RHC75G</i>	4.95
1"	<i>300RHC100</i>	23.20	<i>RHC100</i>	6.05	<i>RHC100G</i>	8.15
1 1/4"	<i>300RHC125</i>	27.55	<i>RHC125</i>	7.80	<i>RHC125G</i>	11.25
1 1/2"	<i>300RHC150</i>	41.25	<i>RHC150</i>	10.40	<i>RHC150G</i>	12.80
2"	<i>300RHC200</i>	59.40	<i>RHC200</i>	15.10	<i>RHC200G</i>	18.60
2 1/2"	---	---	<i>RHC250</i>	41.00	---	---
3"	---	---	<i>RHC300</i>	55.75	<i>RHC300G</i>	76.00
4"	---	---	<i>RHC400</i>	111.00	<i>RHC400G</i>	161.50
5"	---	---	<i>RHC500</i>	436.90	---	---
6"	---	---	<i>RHC600</i>	297.75	---	---

Female NPT	150# 316 Stain.Steel		3000# Forged Steel		125# Brass	
	Part #	Price/E	Part #	Price/E	Part #	Price/E
1/4"	<i>RHC25SS</i>	\$4.55	<i>RHC25FS</i>	\$7.55	<i>RHC25B</i>	\$8.55
3/8"	<i>RHC38SS</i>	5.70	<i>RHC38FS</i>	7.55	<i>RHC38B</i>	7.75
1/2"	<i>RHC50SS</i>	7.65	<i>RHC50FS</i>	4.75	<i>RHC50B</i>	9.65
3/4"	<i>RHC75SS</i>	11.35	<i>RHC75FS</i>	6.15	<i>RHC75B</i>	12.70
1"	<i>RHC100SS</i>	15.85	<i>RHC100FS</i>	10.75	<i>RHC100B</i>	19.25
1 1/4"	<i>RHC125SS</i>	21.15	<i>RHC125FS</i>	17.85	<i>RHC125B</i>	31.00
1 1/2"	<i>RHC150SS</i>	29.65	<i>RHC150FS</i>	23.15	<i>RHC150B</i>	40.90
2"	<i>RHC200SS</i>	43.70	<i>RHC200FS</i>	38.00	<i>RHC200B</i>	67.30
3"	<i>RHC300SS</i>	114.40	---	---	---	---
4"	<i>RHC400SS</i>	177.75	---	---	---	---

Merchant Couplings

- other sizes are also available, consult Dixon® for pricing



Female NPSM	Black Iron	
	Part #	Price/E
1/4"	<i>MRCH25</i>	\$3.70
3/8"	<i>MRCH38</i>	4.45
1/2"	<i>MRCH50</i>	4.75
3/4"	<i>MRCH75</i>	6.00
1"	<i>MRCH100</i>	8.40
1 1/4"	<i>MRCH125</i>	10.75
1 1/2"	<i>MRCH150</i>	13.60
2"	<i>MRCH200</i>	19.50
3"	<i>MRCH300<sup>1</sup></i>	77.80

<sup>1</sup> has female NPT thread

• For additional information on pipe dimensions please reference [dixonvalve.com](http://dixonvalve.com).



NPT Threaded Unions

Features:

- other sizes are also available
- 304 stainless steel fittings are also available, consult Dixon® for pricing and availability

Female NPT	300# Iron		150# Iron		150# Galvanized Iron	
	Part #	Price/E	Part #	Price/E	Part #	Price/E
1/8"	---	---	<b>MIU18</b>	<b>\$18.10</b>	---	---
1/4"	---	---	<b>MIU25</b>	<b>17.20</b>	---	---
3/8"	---	---	<b>MIU38</b>	<b>11.60</b>	<b>TUN038G</b>	<b>\$13.75</b>
1/2"	<b>300MIU50</b>	<b>\$29.30</b>	<b>MIU50</b>	<b>11.10</b>	<b>TUN050G</b>	<b>13.90</b>
3/4"	<b>300MIU75</b>	<b>32.45</b>	<b>MIU75</b>	<b>13.25</b>	<b>TUN075G</b>	<b>16.50</b>
1"	<b>300MIU100</b>	<b>42.35</b>	<b>MIU100</b>	<b>17.30</b>	<b>TUN100G</b>	<b>20.50</b>
1 1/4"	---	---	<b>MIU125</b>	<b>22.90</b>	<b>TUN125G</b>	<b>27.80</b>
1 1/2"	<b>300MIU150</b>	<b>72.25</b>	<b>MIU150</b>	<b>28.00</b>	<b>TUN150G</b>	<b>35.75</b>
2"	---	---	<b>MIU200</b>	<b>42.25</b>	<b>TUN200G</b>	<b>47.60</b>
2 1/2"	---	---	<b>MIU250</b>	<b>102.00</b>	---	---
3"	<b>300MIU300</b>	<b>373.25</b>	<b>MIU300</b>	<b>123.75</b>	---	---
4"	---	---	<b>MIU400</b>	<b>306.00</b>	---	---

Female NPT	150# 316 Stainless Steel		3000# Forged Steel		125# Brass	
	Part #	Price/E	Part #	Price/E	Part #	Price/E
1/4"	<b>TUN025SS</b>	<b>\$19.20</b>	---	---	<b>TUN2F</b>	<b>\$27.50</b>
3/8"	<b>TUN038SS</b>	<b>22.50</b>	---	---	<b>TUN3F</b>	<b>27.50</b>
1/2"	<b>TUN050SS</b>	<b>21.25</b>	<b>TUN050FS</b>	<b>\$20.10</b>	<b>TUN4F</b>	<b>29.90</b>
3/4"	<b>TUN075SS</b>	<b>27.00</b>	<b>TUN075FS</b>	<b>33.05</b>	<b>TUN5F</b>	<b>41.00</b>
1"	<b>TUN100SS</b>	<b>41.40</b>	<b>TUN100FS</b>	<b>43.20</b>	<b>TUN6F</b>	<b>54.50</b>
1 1/4"	<b>TUN125SS</b>	<b>70.00</b>	---	---	<b>TUN7F</b>	<b>79.50</b>
1 1/2"	<b>TUN150SS</b>	<b>79.00</b>	<b>TUN150FS</b>	<b>60.80</b>	<b>TUN8F</b>	<b>94.70</b>
2"	<b>TUN200SS</b>	<b>101.90</b>	<b>TUN200FS</b>	<b>82.35</b>	<b>TUN9F</b>	<b>145.00</b>



300# iron



150# iron



150# galvanized iron



150# 316 stainless steel



3000# forged steel



brass

Pipe, Welding & Tube Fittings

NPT Threaded Reducing Union

Female NPT	Female NPT	150# Iron	
		Part #	Price/E
3/4"	1/2"	<b>MIRU7550</b>	<b>\$21.50</b>



Feature:

- ref SAE 130138

Female Hex Couplings

NPTF	Brass			Pkg Qty	Lead Free Brass <sup>1, 2, 3</sup>	
	Previous Part #	Part #	Price/E		Part #	Price/E
1/8" x 1/8"	BA1F1F	<b>3710202C</b>	<b>\$3.14</b>	25	<b>3710202CLF</b>	<b>\$10.51</b>
1/4" x 1/4"	BA2F2F	<b>3710404C</b>	<b>4.85</b>	25	<b>3710404CLF</b>	<b>11.70</b>
3/8" x 3/8"	BA3F3F	<b>3710606C</b>	<b>5.70</b>	25	<b>3710606CLF</b>	<b>17.48</b>
1/2" x 1/2"	BA4F4F	<b>3710808C</b>	<b>8.70</b>	25	<b>3710808CLF</b>	<b>19.76</b>
3/4" x 3/4"	BA6F6F	<b>3711212C</b>	<b>15.38</b>	10	---	---



<sup>1</sup> lead free brass <=0.25% lead; Alloy CA2745; Alloy C46400  
<sup>2</sup> conforms To: Safe Water Drinking Act (SWDA) of Jan. 4, 2014; California AB1953; RoHS Compliant  
<sup>3</sup> NPT threads

• For additional information on pipe dimensions please reference [dixonvalve.com](http://dixonvalve.com).

NPT Threaded Reducer Hex Bushings



150# iron



150# galvanized iron



150# 316 stainless steel



3000# forged steel



125# brass

Male NPT	Female NPT	150# Iron		150# Galvanized Iron		150# 316 Stainless Steel	
		Part #	Price/E	Part #	Price/E	Part #	Price/E
1/4"	1/8"	<b>HB2518</b>	<b>\$4.50</b>	<b>HB2518G</b>	<b>\$6.45</b>	<b>HB2518SS</b>	<b>\$3.70</b>
3/8"	1/8"	<b>HB3818</b>	<b>4.50</b>	---	---	---	---
	1/4"	<b>HB3825</b>	<b>4.50</b>	<b>HB3825G</b>	<b>6.45</b>	<b>HB3825SS</b>	<b>4.25</b>
1/2"	1/8"	<b>HB5018</b>	<b>4.50</b>	---	---	---	---
	1/4"	<b>HB5025</b>	<b>4.50</b>	<b>HB5025G</b>	<b>6.45</b>	<b>HB5025SS</b>	<b>5.45</b>
	3/8"	<b>HB5038</b>	<b>4.50</b>	<b>HB5038G</b>	<b>6.45</b>	<b>HB5038SS</b>	<b>5.45</b>
3/4"	1/8"	<b>HB7518</b>	<b>4.40</b>	---	---	---	---
	1/4"	<b>HB7525</b>	<b>4.40</b>	<b>HB7525G</b>	<b>6.65</b>	<b>HB7525SS</b>	<b>8.10</b>
	3/8"	<b>HB7538</b>	<b>4.40</b>	<b>HB7538G</b>	<b>7.40</b>	<b>HB7538SS</b>	<b>8.10</b>
	1/2"	<b>HB7550</b>	<b>4.05</b>	<b>HB7550G</b>	<b>6.00</b>	<b>HB7550SS</b>	<b>8.65</b>
1"	1/8"	<b>HB1018</b>	<b>5.10</b>	---	---	---	---
	1/4"	<b>HB1025</b>	<b>5.45</b>	<b>HB1025G</b>	<b>7.90</b>	<b>HB1025SS</b>	<b>12.20</b>
	3/8"	<b>HB1038</b>	<b>5.60</b>	<b>HB1038G</b>	<b>12.40</b>	<b>HB1038SS</b>	<b>11.85</b>
	1/2"	<b>HB1050</b>	<b>4.20</b>	<b>HB1050G</b>	<b>7.15</b>	<b>HB1050SS</b>	<b>11.45</b>
	3/4"	<b>HB1075</b>	<b>4.20</b>	<b>HB1075G</b>	<b>6.75</b>	<b>HB1075SS</b>	<b>11.45</b>
1 1/4"	1/2"	<b>HB1250</b>	<b>6.00</b>	---	---	---	---
	3/4"	<b>HB1275</b>	<b>5.40</b>	---	---	<b>HB1275SS</b>	<b>20.50</b>
	1"	<b>HB1210</b>	<b>5.40</b>	<b>HB1210G</b>	<b>9.15</b>	<b>HB1210SS</b>	<b>20.50</b>
1 1/2"	1/2"	<b>HB1550</b>	<b>6.85</b>	---	---	---	---
	3/4"	<b>HB1575</b>	<b>6.85</b>	<b>HB1575G</b>	<b>13.25</b>	<b>HB1575SS</b>	<b>24.15</b>
	1"	<b>HB1510</b>	<b>6.00</b>	<b>HB1510G</b>	<b>11.90</b>	<b>HB1510SS</b>	<b>24.15</b>
	1 1/4"	<b>HB1512</b>	<b>6.85</b>	<b>HB1512G</b>	<b>11.00</b>	<b>HB1512SS</b>	<b>24.15</b>
2"	1/2"	<b>HB2050</b>	<b>10.30</b>	<b>HB2050G</b>	<b>16.50</b>	---	---
	3/4"	<b>HB2075</b>	<b>8.75</b>	<b>HB2075G</b>	<b>15.40</b>	<b>HB2075SS</b>	<b>35.90</b>
	1"	<b>HB2010</b>	<b>8.20</b>	<b>HB2010G</b>	<b>14.50</b>	<b>HB2010SS</b>	<b>35.90</b>
	1 1/4"	<b>HB2012</b>	<b>8.20</b>	<b>HB2012G</b>	<b>14.50</b>	<b>HB2012SS</b>	<b>35.90</b>
	1 1/2"	<b>HB2015</b>	<b>9.15</b>	<b>HB2015G</b>	<b>12.75</b>	<b>HB2015SS</b>	<b>38.40</b>
2 1/2"	1 1/2"	<b>HB2515</b>	<b>13.80</b>	---	---	---	---
	2"	<b>HB2520</b>	<b>13.75</b>	<b>HB2520G</b>	<b>20.80</b>	<b>HB2520SS</b>	<b>64.40</b>
3"	1"	<b>HB3010</b>	<b>20.60</b>	---	---	---	---
	1 1/2"	<b>HB3015</b>	<b>20.20</b>	---	---	---	---
	2"	<b>HB3020</b>	<b>18.90</b>	<b>HB3020G</b>	<b>28.00</b>	<b>HB3020SS</b>	<b>94.40</b>
	2 1/2"	<b>HB3025</b>	<b>19.10</b>	---	---	<b>HB3025SS</b>	<b>92.15</b>
4"	1"	<b>HB4010</b>	<b>39.40</b>	---	---	---	---
	1 1/2"	<b>HB4015</b>	<b>39.40</b>	---	---	---	---
	2"	<b>HB4020</b>	<b>37.25</b>	<b>HB4020G</b>	<b>58.25</b>	<b>HB4020SS</b>	<b>162.00</b>
	2 1/2"	<b>HB4025</b>	<b>37.25</b>	---	---	---	---
	3"	<b>HB4030</b>	<b>37.25</b>	<b>HB4030G</b>	<b>61.75</b>	<b>HB4030SS</b>	<b>162.00</b>
5"	4"	<b>HB5040</b>	<b>68.00</b>	---	---	---	
6"	3"	<b>HB6030</b>	<b>98.50</b>	---	---	---	---
	4"	<b>HB6040</b>	<b>98.50</b>	---	---	---	---

Male NPT	Female NPT	3000# Forged Steel		125# Brass	
		Part #	Price/E	Part #	Price/E
1/4"	1/8"	<b>HB2518FS</b>	<b>\$3.50</b>	---	---
3/8"	1/8"	---	---	---	---
	1/4"	<b>HB3825FS</b>	<b>3.50</b>	---	---
1/2"	1/8"	---	---	---	---
	1/4"	<b>HB5025FS</b>	<b>3.50</b>	---	---
	3/8"	<b>HB5038FS</b>	<b>3.50</b>	---	---
3/4"	1/8"	---	---	---	---
	1/4"	<b>HB7525FS</b>	<b>4.30</b>	---	---
	3/8"	<b>HB7538FS</b>	<b>4.30</b>	---	---
	1/2"	<b>HB7550FS</b>	<b>4.30</b>	---	---
1"	1/4"	<b>HB1025FS</b>	<b>7.00</b>	---	---
	3/8"	<b>HB1038FS</b>	<b>7.00</b>	---	---
	1/2"	<b>HB1050FS</b>	<b>7.00</b>	---	---
	3/4"	<b>HB1075FS</b>	<b>7.00</b>	---	---
1 1/4"	3/4"	<b>HB1275FS</b>	<b>11.35</b>	---	---
	1"	<b>HB1210FS</b>	<b>11.35</b>	<b>HB1210B</b>	<b>\$21.60</b>
1 1/2"	3/4"	<b>HB1575FS</b>	<b>13.15</b>	<b>HB1575B</b>	<b>33.75</b>
	1"	<b>HB1510FS</b>	<b>13.15</b>	<b>HB1510B</b>	<b>27.60</b>
	1 1/4"	<b>HB1512FS</b>	<b>13.15</b>	<b>HB1512B</b>	<b>27.60</b>
2"	1/2"	---	---	<b>HB2050B</b>	<b>49.50</b>
	3/4"	<b>HB2075FS</b>	<b>19.70</b>	<b>HB2075B</b>	<b>49.50</b>
	1"	<b>HB2010FS</b>	<b>19.70</b>	<b>HB2010B</b>	<b>49.15</b>
	1 1/4"	<b>HB2012FS</b>	<b>19.70</b>	<b>HB2012B</b>	<b>40.90</b>
	1 1/2"	<b>HB2015FS</b>	<b>19.70</b>	<b>HB2015B</b>	<b>40.90</b>
2 1/2"	1 1/2"	---	---	<b>HB2515B</b>	<b>84.25</b>
	2"	<b>HB2520FS</b>	<b>61.60</b>	<b>HB2520B</b>	<b>82.00</b>
3"	2"	<b>HB3020FS</b>	<b>95.30</b>	<b>HB3020B</b>	<b>123.75</b>
	2 1/2"	<b>HB3025FS</b>	<b>95.30</b>	<b>HB3025B</b>	<b>123.65</b>
4"	2"	---	---	<b>HB4020B</b>	<b>371.15</b>
	3"	<b>HB4030FS</b>	<b>206.50</b>	<b>HB4030B</b>	<b>283.45</b>

• For additional information on pipe dimensions please reference dixonvalve.com.



Reducer Hex Bushings

Feature:

- ref SAE 130140

Female NPTF	Male NPTF	Previous Part #	Brass			Lead Free Brass <sup>2, 3, 4</sup>	
			Part #	Price/E	Optional Qty	Part #	Price/E
1/8"	1/4"	HB1F2M	<b>3730402C</b>	<b>\$2.10</b>	100	<b>3730402CLF</b>	<b>\$4.30</b>
1/8"	3/8"	HB1F3M	<b>3730602C</b>	<b>3.30</b>	100	---	---
1/4"	3/8"	HB2F3M	<b>3730604C</b>	<b>2.73</b>	100	<b>3730604CLF</b>	<b>6.06</b>
1/8"	1/2"	HB1F4M	<b>3730802C</b>	<b>4.79</b>	25	---	---
1/4"	1/2"	HB2F4M	<b>3730804C</b>	<b>4.27</b>	50	<b>3730804CLF</b>	<b>11.67</b>
3/8"	1/2"	HB3F4M	<b>3730806C</b>	<b>3.61</b>	50	<b>3730806CLF</b>	<b>10.05</b>
1/8"	3/4"	HB1F6M	<b>3731202C</b> <sup>1</sup>	<b>7.70</b>	25	---	---
1/4"	3/4"	HB2F6M	<b>3731204C</b>	<b>7.85</b>	25	---	---
3/8"	3/4"	HB3F6M	<b>3731206C</b>	<b>6.95</b>	25	---	---
1/2"	3/4"	HB4F6M	<b>3731208C</b>	<b>7.20</b>	25	<b>3731208CLF</b>	<b>15.53</b>
1/4"	1"	HB2F8M	<b>3731604C</b> <sup>1</sup>	<b>15.50</b>	10	---	---
3/8"	1"	HB3F8M	<b>3731606C</b> <sup>1</sup>	<b>14.86</b>	10	---	---
1/2"	1"	HB4F8M	<b>3731608C</b>	<b>14.08</b>	10	---	---
3/4"	1"	HB6F8M	<b>3731612C</b>	<b>11.60</b>	10	---	---



Pipe, Welding & Tube Fittings

- <sup>1</sup> SAE does not provide a standard for these sizes
- <sup>2</sup> lead free brass <=0.25% lead; Alloy CA2745; Alloy C46400
- <sup>3</sup> conforms To: Safe Water Drinking Act (SWDA) of Jan. 4, 2014; California AB1953; RoHS Compliant
- <sup>4</sup> NPT threads

Adapters

Female NPT x Male NPT Adapters

Feature:

- ref SAE 130139

Female NPTF	Male NPTF	Previous Part #	Brass			Lead Free Brass <sup>1, 2, 3</sup>	
			Part #	Price/E	Optional Qty	Part #	Price/E
1/8"	1/8"	RA1F1M	<b>3750202C</b>	<b>\$4.03</b>	100	---	---
1/4"	1/8"	RA2F1M	<b>3750402C</b>	<b>4.28</b>	50	<b>3750402CLF</b>	<b>\$8.96</b>
1/4"	1/4"	RA2F2M	<b>3750404C</b>	<b>4.36</b>	50	<b>3750404CLF</b>	<b>12.03</b>
3/8"	1/8"	RA3F1M	<b>3750602C</b>	<b>7.37</b>	50	---	---
3/8"	1/4"	RA3F2M	<b>3750604C</b>	<b>4.75</b>	50	<b>3750604CLF</b>	<b>15.61</b>
3/8"	3/8"	RA3F3M	<b>3750606C</b>	<b>5.98</b>	50	---	---
1/2"	1/4"	RA4F2M	<b>3750804C</b>	<b>7.05</b>	25	---	---
1/2"	3/8"	RA4F3M	<b>3750806C</b>	<b>6.21</b>	25	---	---
1/2"	1/2"	RA4F4M	<b>3750808C</b>	<b>7.73</b>	25	<b>3750808CLF</b>	<b>25.38</b>
3/4"	3/8"	RA6F3M	<b>3751206C</b>	<b>13.43</b>	10	---	---
3/4"	1/2"	RA6F4M	<b>3751208C</b>	<b>10.65</b>	10	---	---
3/4"	3/4"	RA6F6M	<b>3751212C</b>	<b>13.61</b>	10	<b>3751212CLF</b>	<b>38.25</b>



- <sup>1</sup> lead free brass <=0.25% lead; Alloy CA2745; Alloy C46400
- <sup>2</sup> conforms To: Safe Water Drinking Act (SWDA) of Jan. 4, 2014; California AB1953; RoHS Compliant
- <sup>3</sup> NPT threads

Pump Adapters

Features:

- used to convert BSP pump outlets to NPT
- hard-coated, extruded 6061-T6 aircraft aluminum alloy
- other sizes, configurations are available, contact Dixon®

Female BSP	Male NPT	Aluminum	
		Part #	Price/E
1 1/2"	1 1/2"	<b>AHA15BSP15T</b>	<b>\$105.70</b>
2"	2"	<b>AHA20BSP20T</b>	<b>138.50</b>
2 1/2"	2 1/2"	<b>AHA25BSP25T</b>	<b>95.00</b>
3"	3"	<b>AHA30BSP30T</b>	<b>207.05</b>
4"	4"	<b>AHA40BSP40T</b>	<b>286.40</b>



- For additional information on pipe dimensions please reference [dixonvalve.com](http://dixonvalve.com).

Pipe Nipples

Long Pipe Nipples

- carbon steel and stainless steel nipples are available on page J-9



NPT	Length	Brass			Optional Qty	Lead Free Brass <sup>1,2</sup>	
		Previous Part #	Part #	Price/E		Part #	Price/E
1/8"	1 1/2"	166-0215	<b>1660215C</b>	<b>\$2.51</b>	25	---	---
1/8"	2"	166-0220	<b>1660220C</b>	<b>3.47</b>	25	---	---
1/8"	2 1/2"	166-0225	<b>1660225C</b>	<b>4.22</b>	25	---	---
1/8"	3"	166-0230	<b>1660230C</b>	<b>4.26</b>	25	<b>1660230CLF</b>	<b>\$10.59</b>
1/8"	3 1/2"	166-0235	<b>1660235C</b>	<b>4.67</b>	10	---	---
1/8"	4"	166-0240	<b>1660240C</b>	<b>5.63</b>	10	<b>1660240CLF</b>	<b>8.47</b>
1/4"	1 1/2"	166-0415	<b>1660415C</b>	<b>3.92</b>	25	<b>1660415CLF</b>	<b>6.44</b>
1/4"	2"	166-0420	<b>1660420C</b>	<b>4.94</b>	25	<b>1660420CLF</b>	<b>9.27</b>
1/4"	2 1/2"	166-0425	<b>1660425C</b>	<b>6.57</b>	25	---	---
1/4"	3"	166-0430	<b>1660430C</b>	<b>6.00</b>	25	<b>1660430CLF</b>	<b>16.40</b>
1/4"	3 1/2"	166-0435	<b>1660435C</b>	<b>6.50</b>	10	---	---
1/4"	4"	166-0440	<b>1660440C</b>	<b>6.83</b>	10	<b>1660440CLF</b>	<b>11.39</b>
1/4"	5"	166-0450	<b>1660450C</b>	<b>8.58</b>	5	---	---
3/8"	1 1/2"	166-0615	<b>1660615C</b>	<b>3.87</b>	25	<b>1660615CLF</b>	<b>8.47</b>
3/8"	2"	166-0620	<b>1660620C</b>	<b>5.12</b>	25	<b>1660620CLF</b>	<b>11.42</b>
3/8"	2 1/2"	166-0625	<b>1660625C</b>	<b>7.90</b>	10	<b>1660625CLF</b>	<b>14.89</b>
3/8"	3"	166-0630	<b>1660630C</b>	<b>7.83</b>	10	<b>1660630CLF</b>	<b>17.56</b>
3/8"	3 1/2"	166-0635	<b>1660635C</b>	<b>9.17</b>	10	---	---
3/8"	4"	166-0640	<b>1660640C</b>	<b>10.55</b>	5	<b>1660640CLF</b>	<b>19.53</b>
1/2"	1 1/2"	166-0815	<b>1660815C</b>	<b>5.50</b>	10	<b>1660815CLF</b>	<b>10.38</b>
1/2"	2"	166-0820	<b>1660820C</b>	<b>6.30</b>	10	---	---
1/2"	2 1/2"	166-0825	<b>1660825C</b>	<b>9.45</b>	10	---	---
1/2"	3"	166-0830	<b>1660830C</b>	<b>11.31</b>	10	---	---
1/2"	3 1/2"	166-0835	<b>1660835C</b>	<b>11.79</b>	10	---	---
1/2"	4"	166-0840	<b>1660840C</b>	<b>11.90</b>	5	---	---
3/4"	2"	166-1220	<b>1661220C</b>	<b>9.40</b>	5	---	---
3/4"	2 1/2"	166-1225	<b>1661225C</b>	<b>12.00</b>	5	---	---
3/4"	3"	166-1230	<b>1661230C</b>	<b>13.04</b>	5	---	---
3/4"	3 1/2"	166-1235	<b>1661235C</b>	<b>13.70</b>	5	---	---
1"	2"	---	<b>TN100X2B</b>	<b>21.00</b>	---	---	---
1"	3"	---	<b>TN100X3B</b>	<b>31.50</b>	---	---	---
1"	4"	---	<b>TN100X4B</b>	<b>42.00</b>	---	---	---
1 1/2"	2"	---	<b>TN150X2B</b>	<b>34.15</b>	---	---	---
1 1/2"	3"	---	<b>TN150X3B</b>	<b>47.00</b>	---	---	---
2"	3"	---	<b>TN200X3B</b>	<b>63.00</b>	---	---	---
2"	4"	---	<b>TN200X4B</b>	<b>84.00</b>	---	---	---
2"	6"	---	<b>TN200X6B</b>	<b>116.30</b>	---	---	---

<sup>1</sup> lead free brass <=0.25% lead; Alloy CA2745; Alloy C46400

<sup>2</sup> conforms To: Safe Water Drinking Act (SWDA) of Jan. 4, 2014; California AB1953; RoHS Compliant

Female NPTF x Male NPSM Adapters



Female NPTF	Male NPSM	Brass			Optional Qty
		Previous Part #	Part #	Price/E	
1/4"	1/4"	174-0404	<b>1740404C</b>	<b>\$5.47</b>	100
3/8"	3/8"	174-0606	<b>1740606C</b>	<b>4.99</b>	50
1/2"	1/2"	174-0808	<b>1740808C</b>	<b>7.48</b>	50

- For additional information on pipe dimensions please reference [dixonvalve.com](http://dixonvalve.com).

Pipe Nipples - Threaded Both Ends

Features:

- made from schedule 40 welded pipe
- male NPT x male NPT design
- brass nipples are available, see page J-8
- other lengths are also available, consult Dixon® for pricing

Note: do not use pipe nipples as hose inserts. 

Male NPT	Overall Length	Carbon Steel		316 Stainless Steel	
		Part #	Price/E	Part #	Price/E
1/4"	2"	<b>TN025X2</b>	<b>\$2.45</b>	---	---
1/4"	6"	---	---	<b>TN025X6SS</b>	<b>\$16.80</b>
3/8"	2"	<b>TN038X2</b>	<b>2.70</b>	---	---
3/8"	4"	<b>TN038X4</b>	<b>4.05</b>	---	---
3/8"	6"	<b>TN038X6</b>	<b>6.45</b>	---	---
1/2"	2"	<b>TN050X2</b>	<b>2.10</b>	<b>TN050X2SS</b>	<b>9.75</b>
1/2"	3"	<b>TN050X3</b>	<b>2.50</b>	<b>TN050X3SS</b>	<b>13.80</b>
1/2"	4"	<b>TN050X4</b>	<b>2.95</b>	<b>TN050X4SS</b>	<b>19.80</b>
1/2"	6"	<b>TN050X6</b>	<b>3.90</b>	<b>TN050X6SS</b>	<b>31.20</b>
3/4"	2"	<b>TN075X2</b>	<b>2.60</b>	<b>TN075X2SS</b>	<b>12.20</b>
3/4"	3"	<b>TN075X3</b>	<b>2.95</b>	<b>TN075X3SS</b>	<b>15.50</b>
3/4"	4"	<b>TN075X4</b>	<b>3.60</b>	<b>TN075X4SS</b>	<b>20.25</b>
3/4"	6"	<b>TN075X6</b>	<b>5.15</b>	<b>TN075X6SS</b>	<b>35.15</b>
1"	2"	<b>TN100X2</b>	<b>3.80</b>	<b>TN100X2SS</b>	<b>16.40</b>
1"	3"	<b>TN100X3</b>	<b>4.05</b>	<b>TN100X3SS</b>	<b>23.00</b>
1"	4"	<b>TN100X4</b>	<b>5.00</b>	<b>TN100X4SS</b>	<b>30.00</b>
1"	6"	<b>TN100X6</b>	<b>7.15</b>	<b>TN100X6SS</b>	<b>47.50</b>
1 1/4"	2"	<b>TN125X2</b>	<b>5.00</b>	<b>TN125X2SS</b>	<b>19.00</b>
1 1/4"	3"	<b>TN125X3</b>	<b>5.05</b>	<b>TN125X3SS</b>	<b>26.75</b>
1 1/4"	4"	<b>TN125X4</b>	<b>6.25</b>	<b>TN125X4SS</b>	<b>35.00</b>
1 1/4"	6"	<b>TN125X6</b>	<b>8.90</b>	<b>TN125X6SS</b>	<b>61.20</b>
1 1/2"	2"	<b>TN150X2</b>	<b>5.90</b>	<b>TN150X2SS</b>	<b>21.75</b>
1 1/2"	3"	<b>TN150X3</b>	<b>6.60</b>	<b>TN150X3SS</b>	<b>31.50</b>
1 1/2"	4"	<b>TN150X4</b>	<b>7.40</b>	<b>TN150X4SS</b>	<b>41.00</b>
1 1/2"	6"	<b>TN150X6</b>	<b>10.35</b>	<b>TN150X6SS</b>	<b>71.80</b>
2"	3"	<b>TN200X3</b>	<b>8.55</b>	<b>TN200X3SS</b>	<b>41.00</b>
2"	4"	<b>TN200X4</b>	<b>10.35</b>	<b>TN200X4SS</b>	<b>53.00</b>
2"	5"	<b>TN200X5</b>	<b>12.00</b>	<b>TN200X5SS</b>	<b>66.00</b>
2"	6"	<b>TN200X6</b>	<b>13.95</b>	<b>TN200X6SS</b>	<b>94.15</b>
2"	8"	<b>TN200X8</b>	<b>23.35</b>	---	---
3"	3"	<b>TN300X3</b>	<b>30.05</b>	<b>TN300X3SS</b>	<b>91.00</b>
3"	4"	<b>TN300X4</b>	<b>35.60</b>	<b>TN300X4SS</b>	<b>116.00</b>
3"	6"	<b>TN300X6</b>	<b>42.65</b>	<b>TN300X6SS</b>	<b>191.20</b>
4"	4"	<b>TN400X4</b>	<b>48.15</b>	<b>TN400X4SS</b>	<b>148.00</b>
4"	6"	<b>TN400X6</b>	<b>58.75</b>	<b>TN400X6SS</b>	<b>255.75</b>
4"	8"	<b>TN400X8</b>	<b>81.00</b>	---	---
6"	6"	<b>TN600X6</b>	<b>170.00</b>	---	---
6"	8"	<b>TN600X8</b>	<b>210.00</b>	---	---



carbon steel



stainless steel

Close Pipe Nipples

NPT	Brass			Optional Qty	Lead Free Brass <sup>1,2</sup>	
	Previous Part #	Part #	Price/E		Part #	Price/E
1/8"	165-0202	<b>1650202C</b>	<b>\$1.62</b>	50	<b>1650202CLF</b>	<b>\$3.24</b>
1/4"	165-0404	<b>1650404C</b>	<b>2.20</b>	50	<b>1650404CLF</b>	<b>4.74</b>
3/8"	165-0606	<b>1650606C</b>	<b>2.52</b>	100	<b>1650606CLF</b>	<b>6.56</b>
1/2"	165-0808	<b>1650808C</b>	<b>6.29</b>	25	<b>1650808CLF</b>	<b>8.03</b>
3/4"	165-1212	<b>1651212C</b>	<b>9.60</b>	25	<b>1651212CLF</b>	<b>13.54</b>
1"	165-1616	<b>1651616C</b>	<b>12.70</b>	25	---	---
1 1/2"	---	<b>CN150B</b>	<b>31.75</b>	5	---	---
2"	---	<b>CN200B</b>	<b>48.35</b>	5	---	---
3"	---	<b>CN300B</b>	<b>173.40</b>	5	---	---



<sup>1</sup> lead free brass <=0.25% lead; Alloy CA2745; Alloy C46400

<sup>2</sup> conforms To: Safe Water Drinking Act (SWDA) of Jan. 4, 2014; California AB1953; RoHS Compliant

• For additional information on pipe dimensions please reference [dixonvalve.com](http://dixonvalve.com).

## Threaded Pipe Fittings

### Close Nipples

Pipe, Welding  
& Tube Fittings



**Features:**

- made from schedule 40 welded pipe
- male NPT x male NPT design

Male NPT	Overall Length	Carbon Steel		Galvanized		316 Stainless Steel		Optional Qty
		Part #	Price/E	Part #	Price/E	Part #	Price/E	
1/8"	3/4"	---	---	---	---	CN012SS	\$4.25	1
1/4"	7/8"	CN025	\$2.40	CN025G	\$2.70	CN025SS	4.75	25
3/8"	1"	CN037	2.50	---	---	CN037SS	5.85	25
1/2"	1 1/8"	CN050	2.10	CN050G	2.40	CN050SS	7.80	10
3/4"	1 3/8"	CN075	2.40	CN075G	2.95	CN075SS	10.10	10
1"	1 1/2"	CN100	3.50	CN100G	4.00	CN100SS	14.00	10
1 1/4"	1 5/8"	CN125	4.40	---	---	---	---	10
1 1/2"	1 1/2"	CN150	5.50	CN150G	6.30	CN150SS	23.70	10
2"	2"	CN200	7.45	CN200G	9.35	CN200SS	36.75	10
2 1/2"	2 1/2"	CN250	23.25	---	---	---	---	--
3"	2 5/8"	CN300	27.60	CN300G	31.45	CN300SS	98.80	1
4"	2 3/4"	CN400	41.60	---	---	CN400SS	133.45	5
6"	3 1/8"	CN600	126.75	---	---	---	---	--

### Hex Nipples

**Feature:**

- ref SAE 130137



NPTF	Previous Part #	Brass		Optional Qty	Lead Free Brass <sup>1,2,3</sup>	
		Part #	Price/E		Part #	Price/E
1/8" x 1/8"	BCN12	3700202C	\$3.00	100	3700202CLF	\$4.47
1/4" x 1/4"	BCN25	3700404C	2.81	100	3700404CLF	7.63
3/8" x 3/8"	BCN37	3700606C	4.32	50	3700606CLF	9.95
1/2" x 1/2"	BCN50	3700808C	5.70	25	3700808CLF	17.81
3/4" x 3/4"	BCN75	3701212C	7.50	20	---	---
1" x 1"	BCN100	3701616C	18.00	10	---	---

<sup>1</sup> lead free brass <=0.25% lead; Alloy CA2745; Alloy C46400

<sup>2</sup> conforms To: Safe Water Drinking Act (SWDA) of Jan. 4, 2014; California AB1953; RoHS Compliant

<sup>3</sup> NPT threads

### Straight Hex Nipples



Male NPT	316 Stainless Steel	
	Part #	Price/E
3/8"	HN38SS	\$5.30
1/2"	HN50SS	9.50
3/4"	HN75SS	11.90
1"	HN100SS	16.50
1 1/2"	HN150SS	29.35
2"	HN200SS	41.90

### Reducer Hex Nipples

**Feature:**

- ref SAE 130137



Male NPTF	Previous Part #	Brass		Optional Qty
		Part #	Price/E	
1/4" x 1/8"	HN2M1M	3790402C	\$3.53	100
3/8" x 1/8"	HN3M1M	3790602C	5.62	50
3/8" x 1/4"	HN3M2M	3790604C	4.24	50
1/2" x 1/4"	HN4M2M	3790804C	5.50	50
1/2" x 3/8"	HN4M3M	3790806C	5.57	50
3/4" x 1/2"	HN6M4M	3791208C	8.65	25



Male NPT	Male NPT	316 Stainless Steel	
		Part #	Price/E
3/8"	1/4"	RHN3825SS	\$6.05
1/2"	3/8"	RHN5038SS	6.90
3/4"	1/2"	RHN7550SS	10.20

Note: do not use pipe nipples as hose inserts.



- For additional information on pipe dimensions please reference dixonvalve.com.

Adapters

Ball Seat to Male Pipe

NPSM	NPTF	Previous Part #	Brass		Optional Qty
			Part #	Price/E	
1/8"	1/8"	BSM11	<b>1720202C</b>	<b>\$2.40</b>	100
1/4"	1/8"	BSM21	<b>1720402C</b>	<b>3.20</b>	100
1/4"	1/4"	BSM22	<b>1720404C</b>	<b>2.61</b>	100
3/8"	1/4"	BSM32	<b>1720604C</b>	<b>4.25</b>	100
3/8"	3/8"	BSM33	<b>1720606C</b>	<b>4.24</b>	50
3/8"	1/2"	BSM34	<b>1720608C</b>	<b>8.43</b>	50
1/2"	3/8"	BSM43	<b>1720806C</b>	<b>4.94</b>	50
1/2"	1/2"	BSM44	<b>1720808C</b>	<b>5.80</b>	50
3/4"	3/4"	BSM66	<b>1721212C</b>	<b>7.82</b>	25



Pipe, Welding  
& Tube Fittings

Male Unions

NPSM	NPSM	Previous Part #	Brass		Pkg Qty
			Part #	Price/E	
1/8"	1/8"	176-0202	<b>1760202C</b>	<b>\$3.11</b>	100
1/4"	1/4"	176-0404	<b>1760404C</b>	<b>3.82</b>	100
3/8"	3/8"	176-0606	<b>1760606C</b>	<b>6.23</b>	100
1/2"	1/2"	176-0808	<b>1760808C</b>	<b>7.33</b>	50



• For additional information on pipe dimensions please reference [dixonvalve.com](http://dixonvalve.com).





NPT Threaded 90° Threaded Elbows



300# iron



150# iron



150# galvanized iron



150# 316 stainless steel



2000# forged steel



125# brass

Features:

- other sizes are also available
- 304 stainless steel fittings are also available, consult Dixon® for pricing and availability

Female NPT	300# Iron		150# Iron		150# Galvanized Iron	
	Part #	Price/E	Part #	Price/E	Part #	Price/E
1/8"	---	---	EL9018	\$3.55	EL9018G	\$4.85
1/4"	300EL9025	\$17.55	EL9025	3.35	EL9025G	4.60
3/8"	300EL9038	15.60	EL9038	3.35	EL9038G	4.60
1/2"	300EL9050	20.15	EL9050	2.50	EL9050G	3.05
3/4"	300EL9075	22.80	EL9075	3.05	EL9075G	3.65
1"	300EL90100	30.80	EL90100	5.35	EL90100G	6.85
1 1/4"	300EL90125	42.45	EL90125	8.65	EL90125G	10.50
1 1/2"	300EL90150	50.05	EL90150	11.40	EL90150G	13.90
2"	300EL90200	72.00	EL90200	19.50	EL90200G	23.10
2 1/2"	---	---	EL90250	42.30	---	---
3"	---	---	EL90300	63.00	EL90300G	96.90
4"	---	---	EL90400	134.00	EL90400G	167.50
5"	---	---	EL90500	298.00	---	---
6"	---	---	EL90600	502.00	---	---

Female NPT	150# 316 Stain. Steel		2000# Forged Steel		125# Brass	
	Part #	Price/E	Part #	Price/E	Part #	Price/E
1/8"	EL9018SS	\$6.40	---	---	---	---
1/4"	EL90025SS	6.40	EL9025FS	\$10.40	---	---
3/8"	EL90038SS	7.80	EL9038FS	11.95	---	---
1/2"	EL90050SS	8.60	EL9050FS	10.50	---	---
3/4"	EL90075SS	12.50	EL9075FS	11.45	---	---
1"	EL90100SS	17.60	EL90100FS	14.65	EL90100B	\$24.50
1 1/4"	EL90125SS	26.80	EL90125FS	29.25	---	---
1 1/2"	EL90150SS	35.90	EL90150FS	35.70	EL90150B	48.00
2"	EL90200SS	47.35	EL90200FS	48.95	EL90200B	75.10
3"	EL90300SS	149.00	---	---	---	---
4"	EL90400SS	251.00	---	---	---	---

90° Female Pipe Elbows - Extruded

Feature:

- ref SAE 130238



brass



lead free brass

Female NPTF	Brass			Optional Qty	Lead Free Brass <sup>1,2,3</sup>	
	Previous Part #	Part #	Price/E		Part #	Price/E
1/8"	EL1F1F	3020202C	\$4.50	25	---	---
1/4"	EL2F2F	3020404C	7.11	25	3020404CLF	\$26.79
3/8"	EL3F3F	3020606C	9.69	25	3020606CLF	26.46
1/2"	EL4F4F	3020808C	17.85	25	3020808CLF	26.25
3/4"	EL6F6F	3021212C	26.50	10	3021212CLF	79.08

<sup>1</sup> lead free brass <=0.25% lead; Alloy CA2745; Alloy C46400

<sup>2</sup> conforms To: Safe Water Drinking Act (SWDA) of Jan. 4, 2014; California AB1953; RoHS Compliant

<sup>3</sup> NPT thread

• For additional information on pipe dimensions please reference [dixonvalve.com](http://dixonvalve.com).



NPT Threaded Reducing Elbows

Feature:

- other sizes are also available, consult Dixon® for pricing and availability

Female NPT		Female NPT		150# Iron	
				Part #	Price/E
1/4"	1/8"			<b>REL2518</b>	<b>\$6.55</b>
1/2"	1/4"			<b>REL5025</b>	<b>4.70</b>
1/2"	3/8"			<b>REL5038</b>	<b>4.60</b>
3/4"	1/2"			<b>REL7550</b>	<b>4.75</b>
1"	1/2"			<b>REL1050</b>	<b>6.45</b>
1"	3/4"			<b>REL1075</b>	<b>6.10</b>
1 1/4"	1"			<b>REL1210</b>	<b>9.90</b>
1 1/2"	1"			<b>REL1510</b>	<b>16.25</b>
1 1/2"	1 1/4"			<b>REL1525</b>	<b>16.25</b>
2"	1"			<b>REL2010</b>	<b>23.40</b>
2"	1 1/2"			<b>REL2015</b>	<b>20.60</b>
2 1/2"	2"			<b>REL2520</b>	<b>56.30</b>
3"	2"			<b>REL3020</b>	<b>91.00</b>
4"	2"			<b>REL4020</b>	<b>156.00</b>
4"	3"			<b>REL4030</b>	<b>156.00</b>



Pipe, Welding  
& Tube Fittings

90° Street Elbows - Extruded

Feature:

- ref SAE 130239

Female NPTF	Male NPTF	Previous Part #	Brass			Lead Free Brass <sup>1,2</sup>	
			Part #	Price/E	Optional Qty	Part #	Price/E
1/8"	1/8"	SE1F1M	<b>3040202C</b>	<b>\$4.41</b>	25	<b>3040202CLF</b>	<b>\$16.58</b>
1/4"	1/8"	SE2F1M	<b>3040402C</b>	<b>6.43</b>	25	---	---
1/4"	1/4"	SE2F2M	<b>3040404C</b>	<b>7.03</b>	25	<b>3040404CLF</b>	<b>9.34</b>
3/8"	1/4"	SE3F2M	<b>3040604C</b>	<b>8.59</b>	25	---	---
3/8"	3/8"	SE3F3M	<b>3040606C</b>	<b>9.71</b>	25	<b>3040606CLF</b>	<b>12.96</b>
1/2"	3/8"	SE4F3M	<b>3040806C</b>	<b>15.55</b>	25	---	---
1/2"	1/2"	SE4F4M	<b>3040808C</b>	<b>17.35</b>	25	<b>3040808CLF</b>	<b>24.67</b>
3/4"	1/2"	SE6F4M	<b>3041208C</b>	<b>20.77</b>	25	---	---
3/4"	3/4"	SE6F6M	<b>3041212C</b>	<b>25.95</b>	10	---	---



brass



lead free brass

<sup>1</sup> lead free brass <=0.25% lead; Alloy CA2745; Alloy C46400

<sup>2</sup> conforms To: Safe Water Drinking Act (SWDA) of Jan. 4, 2014; California AB1953; RoHS Compliant

<sup>3</sup> NPT thread

90° Male Pipe Elbows - Forged

Male NPTF	Previous Part #	Brass		Optional Qty
		Part #	Price/E	
1/8"	169-0202	<b>1690202C</b>	<b>\$3.45</b>	25
1/4"	169-0404	<b>1690404C</b>	<b>4.76</b>	25
3/8"	169-0606	<b>1690606C</b>	<b>6.85</b>	25
1/2"	169-0808	<b>1690808C</b>	<b>11.45</b>	25



• For additional information on pipe dimensions please reference [dixonvalve.com](http://dixonvalve.com).

NPT Threaded 90° Street Elbows



150# iron

**Features:**

- other sizes are also available
- 304 stainless steel fittings are also available, consult Dixon® for pricing and availability



150# galvanized iron



150# 316 stainless steel

Male NPT	Female NPT	150# Iron		150# Galvanized Iron		150# 316 Stain. Steel	
		Part #	Price/E	Part #	Price/E	Part #	Price/E
1/8"	1/8"	<b>SE9018</b>	<b>\$5.05</b>	<b>SE9018G</b>	<b>\$6.55</b>	<b>SE9018SS</b>	<b>\$8.60</b>
1/4"	1/4"	<b>SE9025</b>	<b>5.05</b>	<b>SE9025G</b>	<b>6.30</b>	<b>SE9025SS</b>	<b>8.75</b>
3/8"	3/8"	<b>SE9038</b>	<b>5.05</b>	<b>SE9038G</b>	<b>6.30</b>	<b>SE9038SS</b>	<b>10.80</b>
1/2"	1/2"	<b>SE9050</b>	<b>5.20</b>	<b>SE9050G</b>	<b>6.50</b>	<b>SE9050SS</b>	<b>12.70</b>
3/4"	3/4"	<b>SE9075</b>	<b>5.05</b>	<b>SE9075G</b>	<b>6.30</b>	<b>SE9075SS</b>	<b>16.70</b>
1"	1"	<b>SE9010</b>	<b>7.30</b>	<b>SE9010G</b>	<b>8.60</b>	<b>SE9010SS</b>	<b>26.75</b>
1 1/4"	1 1/4"	<b>SE9012</b>	<b>11.10</b>	<b>SE9012G</b>	<b>14.40</b>	<b>SE9012SS</b>	<b>39.75</b>
1 1/2"	1 1/2"	<b>SE9015</b>	<b>14.90</b>	<b>SE9015G</b>	<b>17.80</b>	<b>SE9015SS</b>	<b>52.00</b>
2"	2"	<b>SE9020</b>	<b>24.00</b>	<b>SE9020G</b>	<b>30.75</b>	<b>SE9020SS</b>	<b>64.00</b>
2 1/2"	2 1/2"	<b>SE90250</b>	<b>59.50</b>	---	---	---	---
3"	3"	<b>SE90300</b>	<b>90.75</b>	<b>SE9030G</b>	<b>126.00</b>	---	---
4"	4"	<b>SE90400</b>	<b>147.80</b>	---	---	---	---
6"	6"	<b>SE90600</b>	<b>486.60</b>	---	---	---	---



3000# forged steel



125# brass

Male NPT	Female NPT	3000# Forged Steel		125# Brass	
		Part #	Price/E	Part #	Price/E
1/8"	1/8"	---	---	---	---
1/4"	1/4"	<b>SE9025FS</b>	<b>\$22.15</b>	---	---
3/8"	3/8"	<b>SE9038FS</b>	<b>21.30</b>	---	---
1/2"	1/2"	<b>SE9050FS</b>	<b>21.30</b>	---	---
3/4"	3/4"	<b>SE9075FS</b>	<b>26.95</b>	<b>SE9075B</b>	<b>\$20.50</b>
1"	1"	<b>SE9010FS</b>	<b>35.95</b>	<b>SE9010B</b>	<b>33.75</b>
1 1/4"	1 1/4"	<b>SE9012FS</b>	<b>65.10</b>	<b>SE9012B</b>	<b>51.70</b>
1 1/2"	1 1/2"	<b>SE9015FS</b>	<b>78.70</b>	<b>SE9015B</b>	<b>67.50</b>
2"	2"	<b>SE9020FS</b>	<b>113.50</b>	<b>SE9020B</b>	<b>114.50</b>

• For additional information on pipe dimensions please reference [dixonvalve.com](http://dixonvalve.com).

NPT Threaded 45° Threaded Elbows

Female NPT	150# Iron	
	Part #	Price/E
1/8"	<b>EL4518</b>	<b>\$5.10</b>
1/4"	<b>EL4525</b>	<b>5.20</b>
3/8"	<b>EL4538</b>	<b>4.70</b>
1/2"	<b>EL4550</b>	<b>4.10</b>
3/4"	<b>EL4575</b>	<b>5.00</b>
1"	<b>EL45100</b>	<b>6.35</b>
1 1/4"	<b>EL45125</b>	<b>11.10</b>
1 1/2"	<b>EL45150</b>	<b>13.75</b>
2"	<b>EL45200</b>	<b>20.75</b>
2 1/2"	<b>EL45250</b>	<b>58.40</b>
3"	<b>EL45300</b>	<b>75.90</b>
4"	<b>EL45400</b>	<b>147.25</b>
5"	<b>EL45500</b>	<b>488.25</b>
6"	<b>EL45600</b>	<b>502.00</b>



Pipe, Welding  
& Tube Fittings

NPT Threaded 45° Street Elbows

Size	150# Iron		150# Galvanized Iron	
	Part #	Price/E	Part #	Price/E
1/8"	<b>SE4518</b>	<b>\$7.85</b>	---	---
1/4"	<b>SE4525</b>	<b>5.90</b>	<b>SE4525G</b>	<b>\$7.75</b>
3/8"	<b>SE4538</b>	<b>6.65</b>	---	---
1/2"	<b>SE4550</b>	<b>5.35</b>	<b>SE4550G</b>	<b>6.80</b>
3/4"	<b>SE4575</b>	<b>8.25</b>	<b>SE4575G</b>	<b>11.10</b>
1"	<b>SE45100</b>	<b>9.55</b>	---	---
1 1/4"	<b>SE45125</b>	<b>16.50</b>	<b>SE45125G</b>	<b>20.50</b>
1 1/2"	<b>SE45150</b>	<b>20.50</b>	<b>SE45150G</b>	<b>24.75</b>
2"	<b>SE45200</b>	<b>34.60</b>	<b>SE45200G</b>	<b>42.50</b>
2 1/2"	<b>SE45250</b>	<b>73.50</b>	<b>SE45250G</b>	<b>100.00</b>
3"	<b>SE45300</b>	<b>112.60</b>	<b>SE45300G</b>	<b>149.50</b>
4"	<b>SE45400</b>	<b>211.00</b>	<b>SE45400G</b>	<b>243.10</b>



150# galvanized iron

Elbows

45° Street Elbows - Extruded

Feature:

- ref SAE 130339

Female NPTF	Male NPTF	Previous Part #	Brass		Optional Qty
			Part #	Price/E	
1/8"	1/8"	306-0202	<b>3060202C</b>	<b>\$4.55</b>	25
1/4"	1/4"	306-0404	<b>3060404C</b>	<b>4.91</b>	25
3/8"	3/8"	306-0606	<b>3060606C</b>	<b>7.55</b>	25
1/2"	1/2"	306-0808	<b>3060808C</b>	<b>13.23</b>	25
3/4"	3/4"	306-1212	<b>3061212C</b>	<b>21.45</b>	10



• For additional information on pipe dimensions please reference dixonvalve.com.

NPT Threaded Female Tees



300# iron



150# iron



150# galvanized iron



150# 316 stainless steel



2000# forged steel



125# brass

Female NPT	300# Iron		150# Iron		150# Galvanized Iron	
	Part #	Price/E	Part #	Price/E	Part #	Price/E
1/8"	---	---	<b>FT18</b>	<b>\$5.55</b>	---	---
1/4"	<b>300FT25</b>	<b>\$22.05</b>	<b>FT25</b>	<b>5.05</b>	<b>FT25G</b>	<b>\$6.00</b>
3/8"	<b>300FT38</b>	<b>23.35</b>	<b>FT38</b>	<b>5.05</b>	<b>FT38G</b>	<b>6.00</b>
1/2"	<b>300FT50</b>	<b>29.70</b>	<b>FT50</b>	<b>3.30</b>	<b>FT50G</b>	<b>3.70</b>
3/4"	---	---	<b>FT75</b>	<b>4.65</b>	<b>FT75G</b>	<b>6.20</b>
1"	<b>300FT10</b>	<b>38.60</b>	<b>FT10</b>	<b>8.20</b>	<b>FT100G</b>	<b>10.10</b>
1 1/4"	<b>300FT120</b>	<b>55.30</b>	<b>FT120</b>	<b>13.30</b>	<b>FT120G</b>	<b>16.00</b>
1 1/2"	---	---	<b>FT15</b>	<b>16.50</b>	<b>FT150G</b>	<b>20.00</b>
2"	<b>300FT200</b>	<b>95.15</b>	<b>FT200</b>	<b>28.00</b>	<b>FT200G</b>	<b>33.30</b>
2 1/2"	---	---	<b>FT250</b>	<b>57.70</b>	---	---
3"	---	---	<b>FT30</b>	<b>86.60</b>	<b>FT300G</b>	<b>104.90</b>
4"	---	---	<b>FT40</b>	<b>203.40</b>	<b>FT400G</b>	<b>247.90</b>
5"	---	---	<b>FT500</b>	<b>548.25</b>	---	---
6"	---	---	<b>FT60</b>	<b>581.10</b>	---	---

Female NPT	150# 316 Stainless Steel		2000# Forged Steel		125# Brass	
	Part #	Price/E	Part #	Price/E	Part #	Price/E
1/8"	---	---	---	---	---	---
1/4"	<b>FT25SS</b>	<b>\$8.00</b>	<b>FT25FS</b>	<b>\$13.25</b>	---	---
3/8"	<b>FT38SS</b>	<b>10.60</b>	---	---	---	---
1/2"	<b>FT50SS</b>	<b>11.20</b>	<b>FT50FS</b>	<b>12.70</b>	---	---
3/4"	<b>FT75SS</b>	<b>16.50</b>	<b>FT75FS</b>	<b>17.20</b>	<b>FT75B</b>	<b>\$19.40</b>
1"	<b>FT10SS</b>	<b>23.40</b>	<b>FT100FS</b>	<b>23.90</b>	<b>FT10B</b>	<b>34.50</b>
1 1/4"	<b>FT120SS</b>	<b>41.00</b>	<b>FT120FS</b>	<b>42.20</b>	---	---
1 1/2"	<b>FT150SS</b>	<b>50.00</b>	<b>FT150FS</b>	<b>51.10</b>	<b>FT15B</b>	<b>66.10</b>
2"	<b>FT200SS</b>	<b>65.00</b>	<b>FT200FS</b>	<b>63.90</b>	<b>FT20B</b>	<b>108.25</b>

Female Tees - Extruded

Feature:

- ref SAE 130438



brass



lead free brass

NPTF Thread	Brass			Optional Qty	Lead Free Brass <sup>1,2,3</sup>	
	Previous Part #	Part #	Price/E		Part #	Price/E
1/8"	322-0202	<b>3220202C</b>	<b>\$5.00</b>	25	<b>3220202CLF</b>	<b>\$20.17</b>
1/4"	322-0404	<b>3220404C</b>	<b>8.60</b>	25	<b>3220404CLF</b>	<b>16.86</b>
3/8"	322-0606	<b>3220606C</b>	<b>11.61</b>	25	<b>3220606CLF</b>	<b>25.71</b>
1/2"	322-0808	<b>3220808C</b>	<b>22.28</b>	25	<b>3220808CLF</b>	<b>34.06</b>
3/4"	322-1212	<b>3221212C</b>	<b>29.60</b>	10	<b>3221212CLF</b>	<b>124.45</b>

<sup>1</sup> lead free brass <=0.25% lead; Alloy CA2745; Alloy C46400

<sup>2</sup> conforms To: Safe Water Drinking Act (SWDA) of Jan. 4, 2014; California AB1953; RoHS Compliant

<sup>3</sup> NPT thread

• For additional information on pipe dimensions please reference dixonvalve.com.

NPT Threaded Side Outlet Elbows

Female NPT	150# Iron	
	Part #	Price/E
1/8"	<b>SOE18</b>	<b>\$11.10</b>
1/4"	<b>SOE25</b>	<b>11.10</b>
3/8"	<b>SOE38</b>	<b>11.10</b>
1/2"	<b>SOE50</b>	<b>11.10</b>
3/4"	<b>SOE75</b>	<b>11.90</b>
1"	<b>SOE100</b>	<b>30.45</b>
1 1/4"	<b>SOE120</b>	<b>26.60</b>
1 1/2"	<b>SOE150</b>	<b>35.65</b>
2"	<b>SOE200</b>	<b>68.50</b>



Pipe, Welding  
& Tube Fittings

NPT Threaded Female Reducing Tees

Female NPT	Female NPT	150# Iron	
		Part #	Price/E
3/8"	1/4"	<b>FRT3825</b>	<b>\$6.75</b>
1/2"	3/8"	<b>FRT5038</b>	<b>7.00</b>
3/4"	1/2"	<b>FRT7550</b>	<b>7.15</b>
1"	1/2"	<b>FRT1050</b>	<b>9.15</b>
1 1/4"	1"	<b>FRT1210</b>	<b>14.50</b>
1 1/2"	1"	<b>FRT1510</b>	<b>18.30</b>
2"	1"	<b>FRT2010</b>	<b>28.70</b>
2"	1 1/2"	<b>FRT2015</b>	<b>30.25</b>
3"	2"	<b>FRT3020</b>	<b>100.25</b>



NPT Threaded Street Service Tees

NPT	150# Iron	
	Part #	Price/E
1/2"	<b>SST50</b>	<b>\$11.75</b>
3/4"	<b>SST75</b>	<b>15.90</b>
1"	<b>SST100</b>	<b>21.00</b>
1 1/2"	<b>SST150</b>	<b>48.00</b>



NPT Threaded Bull Head Tees

Female NPT	Female NPT	150# Iron	
		Part #	Price/E
1/2"	3/4"	<b>BHT1575</b>	<b>\$8.15</b>
1/2"	1"	<b>BHT1510</b>	<b>11.90</b>
3/4"	1"	<b>BHT7510</b>	<b>10.40</b>
1"	1 1/2"	<b>BHT1015</b>	<b>28.75</b>
1"	2"	<b>BHT1020</b>	<b>35.20</b>
1 1/2"	2"	<b>BHT1520</b>	<b>35.20</b>
2"	2 1/2"	<b>BHT2025</b>	<b>75.25</b>



NPT Threaded Side Outlet Tees

Female NPT	150# Iron	
	Part #	Price/E
1/2"	<b>SOT50</b>	<b>\$14.40</b>
3/4"	<b>SOT75</b>	<b>18.55</b>
1"	<b>SOT100</b>	<b>33.65</b>
1 1/4"	<b>SOT120</b>	<b>46.60</b>
1 1/2"	<b>SOT150</b>	<b>49.75</b>
2"	<b>SOT200</b>	<b>76.50</b>



• For additional information on pipe dimensions please reference [dixonvalve.com](http://dixonvalve.com).

Street Tees - Extruded

Feature:

- ref SAE 130424



Female NPTF	Male NPTF	Brass			Optional Qty	Lead Free Brass <sup>1, 2, 3</sup>	
		Previous Part #	Part #	Price/E		Part #	Price/E
1/8"	1/8"	326-0202	<b>3260202C</b>	<b>\$5.15</b>	25	---	---
1/4"	1/4"	326-0404	<b>3260404C</b>	<b>8.25</b>	25	<b>3260404CLF</b>	<b>\$40.03</b>
3/8"	3/8"	326-0606	<b>3260606C</b>	<b>11.40</b>	25	---	---
1/2"	1/2"	326-0808	<b>3260808C</b>	<b>22.30</b>	25	---	---
3/4"	3/4"	326-1212	<b>3261212C</b>	<b>34.80</b>	10	---	---

<sup>1</sup> lead free brass <=0.25% lead; Alloy CA2745; Alloy C46400

<sup>2</sup> conforms To: Safe Water Drinking Act (SWDA) of Jan. 4, 2014; California AB1953; RoHS Compliant

<sup>3</sup> NPT thread

Male Branch Tees - Extruded

Feature:

- ref SAE 130425



NPTF	Brass			Optional Qty	Lead Free Brass <sup>1, 2, 3</sup>	
	Previous Part #	Part #	Price/E		Part #	Price/E
1/8"	324-0202	<b>3240202C</b>	<b>\$5.96</b>	25	---	---
1/4"	324-0404	<b>3240404C</b>	<b>9.25</b>	25	---	---
3/8"	324-0606	<b>3240606C</b>	<b>11.61</b>	25	<b>3240606CLF</b>	<b>\$46.88</b>
1/2"	324-0808	<b>3240808C</b>	<b>20.83</b>	25	---	---
3/4"	324-1212	<b>3241212C</b>	<b>35.19</b>	10	---	---

<sup>1</sup> lead free brass <=0.25% lead; Alloy CA2745; Alloy C46400

<sup>2</sup> conforms To: Safe Water Drinking Act (SWDA) of Jan. 4, 2014; California AB1953; RoHS Compliant

<sup>3</sup> NPT thread

NPT Threaded Crosses



Female NPT	150# Iron	
	Part #	Price/E
1/8"	<b>MIC18</b>	<b>\$12.10</b>
1/4"	<b>MIC25</b>	<b>10.30</b>
3/8"	<b>MIC38</b>	<b>10.50</b>
1/2"	<b>MIC50</b>	<b>11.90</b>
3/4"	<b>MIC75</b>	<b>14.50</b>
1"	<b>MIC100</b>	<b>17.90</b>
1 1/4"	<b>MIC125</b>	<b>29.00</b>
1 1/2"	<b>MIC150</b>	<b>36.00</b>
2"	<b>MIC200</b>	<b>59.50</b>
2 1/2"	<b>MIC250</b>	<b>105.00</b>
3"	<b>MIC300</b>	<b>156.50</b>
4"	<b>MIC400</b>	<b>319.50</b>

Pipe Crosses - Extruded



Female NPTF	Brass			Optional Qty
	Previous Part #	Part #	Price/E	
1/8"	228-0202	<b>2280202C</b>	<b>\$6.34</b>	25
1/4"	228-0404	<b>2280404C</b>	<b>10.67</b>	25
3/8"	228-0606	<b>2280606C</b>	<b>12.93</b>	25
1/2"	228-0808	<b>2280808C</b>	<b>27.50</b>	10
3/4"	228-1212	<b>2281212C</b>	<b>41.45</b>	10

- For additional information on pipe dimensions please reference dixonvalve.com.



NPT Threaded Caps

Features:

- other sizes are also available
- 304 stainless steel fittings are also available, consult Dixon® for pricing and availability

Female NPT	300# Iron		150# Iron	
	Part #	Price/E	Part #	Price/E
1/8"	---	---	<b>MICAP18</b>	<b>\$3.30</b>
1/4"	---	---	<b>MICAP25</b>	<b>3.30</b>
3/8"	---	---	<b>MICAP38</b>	<b>3.30</b>
1/2"	<b>300MICAP50</b>	<b>\$16.10</b>	<b>MICAP50</b>	<b>2.50</b>
3/4"	<b>300MICAP75</b>	<b>20.25</b>	<b>MICAP75</b>	<b>3.40</b>
1"	<b>300MICAP100</b>	<b>26.60</b>	<b>MICAP100</b>	<b>4.10</b>
1 1/4"	<b>300MICAP125</b>	<b>29.45</b>	<b>MICAP120</b>	<b>5.35</b>
1 1/2"	<b>300MICAP150</b>	<b>43.05</b>	<b>MICAP150</b>	<b>7.30</b>
2"	<b>300MICAP200</b>	<b>59.75</b>	<b>MICAP200</b>	<b>9.55</b>
2 1/2"	---	---	<b>MICAP250</b>	<b>23.70</b>
3"	---	---	<b>MICAP300</b>	<b>35.20</b>
4"	---	---	<b>MICAP400</b>	<b>55.00</b>
5"	---	---	<b>MICAP500</b>	<b>115.50</b>
6"	---	---	<b>MICAP600</b>	<b>219.50</b>



300# iron



150# iron



150# galvanized iron



150# 316 stainless steel

Female NPT	150# Galvanized Iron		150# 316 Stainless Steel	
	Part #	Price/E	Part #	Price/E
1/8"	---	---	<b>SSCAP18</b>	<b>\$3.35</b>
1/4"	---	---	<b>SSCAP25</b>	<b>4.10</b>
3/8"	---	---	<b>SSCAP38</b>	<b>4.90</b>
1/2"	<b>MICAP50G</b>	<b>\$3.20</b>	<b>SSCAP50</b>	<b>5.60</b>
3/4"	<b>MICAP75G</b>	<b>4.60</b>	<b>SSCAP75</b>	<b>7.40</b>
1"	---	---	<b>SSCAP10</b>	<b>9.85</b>
1 1/4"	---	---	<b>SSCAP12</b>	<b>19.50</b>
1 1/2"	---	---	<b>SSCAP15</b>	<b>25.00</b>
2"	<b>MICAP200G</b>	<b>11.80</b>	<b>SSCAP20</b>	<b>36.75</b>

NPT Pipe Caps

Female NPT	Optional Qty	Lead Free Brass <sup>1, 2, 3</sup>	
		Part #	Price/E
1/8"	50	<b>2130200CLF</b>	<b>\$3.10</b>
1/4"	100	<b>2130400CLF</b>	<b>3.72</b>
3/8"	25	<b>2130600CLF</b>	<b>6.20</b>
1/2"	25	<b>2130800CLF</b>	<b>10.77</b>
3/4"	25	<b>2131200CLF</b>	<b>15.66</b>



<sup>1</sup> lead free per NSF/ANSI 372

<sup>2</sup> lead free brass <=0.25% lead; Alloy CA2745; Alloy C46400

<sup>3</sup> conforms To: Safe Water Drinking Act (SWDA) of Jan. 4, 2014; California AB1953; RoHS Compliant

• For additional information on pipe dimensions please reference [dixonvalve.com](http://dixonvalve.com).

NPT Threaded Square Head Plugs

Feature:

- forged steel plugs are solid, all others are cored



150# iron



150# galvanized iron



150# 316 stainless steel



3000# forged steel

Male NPT	150# Iron		150# Galvanized Iron		150# 316 Stain. Steel	
	Part #	Price/E	Part #	Price/E	Part #	Price/E
1/8"	<b>SHP18</b>	<b>\$2.15</b>	<b>SHP18G</b>	<b>\$3.30</b>	<b>SHP18SS</b>	<b>\$3.20</b>
1/4"	<b>SHP14</b>	<b>2.15</b>	<b>SHP14G</b>	<b>3.50</b>	<b>SHP14SS</b>	<b>3.40</b>
3/8"	<b>SHP38</b>	<b>2.15</b>	<b>SHP38G</b>	<b>3.50</b>	<b>SHP38SS</b>	<b>3.90</b>
1/2"	<b>SHP50</b>	<b>2.30</b>	<b>SHP50G</b>	<b>4.40</b>	<b>SHP50SS</b>	<b>5.50</b>
3/4"	<b>SHP75</b>	<b>2.30</b>	<b>SHP75G</b>	<b>4.40</b>	<b>SHP75SS</b>	<b>6.75</b>
1"	<b>SHP100</b>	<b>2.90</b>	<b>SHP100G</b>	<b>4.85</b>	<b>SHP100SS</b>	<b>8.75</b>
1 1/4"	<b>SHP125</b>	<b>3.65</b>	<b>SHP125G</b>	<b>7.45</b>	<b>SHP125SS</b>	<b>20.00</b>
1 1/2"	<b>SHP150</b>	<b>5.05</b>	<b>SHP150G</b>	<b>10.00</b>	<b>SHP150SS</b>	<b>22.00</b>
2"	<b>SHP200</b>	<b>7.20</b>	<b>SHP200G</b>	<b>12.75</b>	<b>SHP200SS</b>	<b>30.50</b>
2 1/2"	<b>SHP250</b>	<b>13.10</b>	<b>SHP250G</b>	<b>24.80</b>	<b>SHP250SS</b>	<b>49.00</b>
3"	<b>SHP300</b>	<b>18.00</b>	<b>SHP300G</b>	<b>35.25</b>	<b>SHP300SS</b>	<b>59.50</b>
4"	<b>SHP400</b>	<b>37.80</b>	<b>SHP400G</b>	<b>73.10</b>	<b>SHP400SS</b>	<b>131.00</b>
5"	<b>SHP500</b>	<b>81.00</b>	---	---	---	---
6"	<b>SHP600</b>	<b>131.70</b>	<b>SHP600G</b>	<b>145.10</b>	---	---

Male NPT	3000# Forged Steel		125# Brass	
	Part #	Price/E	Part #	Price/E
1/8"	---	---	<b>2110200C</b> <sup>1,2</sup>	<b>\$2.41</b>
1/4"	<b>SHP14FS</b>	<b>\$2.55</b>	<b>2110400C</b> <sup>1,2</sup>	<b>4.00</b>
3/8"	<b>SHP38FS</b>	<b>2.65</b>	<b>2110600C</b> <sup>1,2</sup>	<b>6.00</b>
1/2"	<b>SHP50FS</b>	<b>2.75</b>	<b>2110800C</b> <sup>1,2</sup>	<b>10.88</b>
3/4"	<b>SHP75FS</b>	<b>3.50</b>	<b>2111200C</b> <sup>1,2</sup>	<b>16.78</b>
1"	<b>SHP100FS</b>	<b>5.30</b>	<b>SHP100B</b>	<b>16.50</b>
1 1/2"	<b>SHP150FS</b>	<b>12.35</b>	<b>SHP150B</b>	<b>23.00</b>
2"	<b>SHP200FS</b>	<b>19.90</b>	---	---
3"	<b>SHP300FS</b>	<b>84.15</b>	---	---

<sup>1</sup> lead free brass per NSF/ANSI 372, Brass Alloy 260/270

<sup>2</sup> threads are PTF-SAE

Hex Head Plugs

NPT	Brass			Pkg Qty	Lead Free Brass <sup>1,2</sup>	
	Previous Part #	Part #	Price/E		Part #	Price/E
1/8"	HHP1M	<b>1630200C</b>	<b>\$2.23</b>	50	<b>1630200CLF</b>	<b>\$2.36</b>
1/4"	HHP2M	<b>1630400C</b>	<b>2.04</b>	100	<b>1630400CLF</b>	<b>3.16</b>
3/8"	HHP3M	<b>1630600C</b>	<b>2.84</b>	25	---	---
1/2"	HHP4M	<b>1630800C</b>	<b>4.42</b>	25	---	---
3/4"	HHP6M	<b>1631200C</b>	<b>6.62</b>	25	---	---
1"	HHP8M	<b>1631600C</b>	<b>13.10</b>	10	---	---



- standard brass hex head plug is hollow; lead free brass is solid

<sup>1</sup> lead free brass <=0.25% lead; Alloy CA2745; Alloy C46400

<sup>2</sup> conforms To: Safe Water Drinking Act (SWDA) of Jan. 4, 2014; California AB1953; RoHS Compliant

Hex Socket Plugs

NPTF	Lead Free Brass <sup>1</sup>			Optional Qty
	Previous Part #	Part #	Price/E	
1/8"	219-0200	<b>2190200C</b>	<b>\$1.34</b>	50
1/4"	219-0400	<b>2190400C</b>	<b>2.40</b>	100
3/8"	219-0600	<b>2190600C</b>	<b>3.60</b>	25
1/2"	219-0800	<b>2190800C</b>	<b>6.84</b>	25
3/4"	219-1200	<b>2191200C</b>	<b>10.00</b>	25



<sup>1</sup> lead free brass per NSF/ANSI 372, Brass Alloy 260/270

- For additional information on pipe dimensions please reference dixonvalve.com.

Polypropylene Schedule 80 - Pipe Couplings

Female NPT	Polypropylene	
	Part #	Price/E
3/4"	<b>62238</b>	<b>\$5.45</b>
1"	<b>62239</b>	<b>6.50</b>
1 1/2"	<b>62241</b>	<b>15.00</b>
2"	<b>62194</b>	<b>16.10</b>



Pipe, Welding  
& Tube Fittings

Tuff-Lite™ - Female NPT x Female NPT Adapters

- sold in package quantity only

Female NPT	Female NPT	Nylon		Pkg Qty
		Part #	Price/E	
1/2"	1/2"	<b>TA994</b>	<b>\$4.35</b>	25
3/4"	3/4"	<b>TA996</b>	<b>4.70</b>	25



Polypropylene Schedule 80 - Reducer Bushings

Male NPT	Female NPT	Polypropylene	
		Part #	Price/E
1/2"	1/4"	<b>62267</b>	<b>\$3.35</b>
3/4"	1/2"	<b>62272</b>	<b>3.35</b>
1"	1/2"	<b>62275</b>	<b>3.60</b>
1"	3/4"	<b>62276</b>	<b>3.60</b>
1 1/4"	3/4"	<b>62277</b>	<b>3.70</b>
1 1/4"	1"	<b>62278</b>	<b>3.70</b>
1 1/2"	3/4"	<b>62279</b>	<b>5.35</b>
1 1/2"	1"	<b>62280</b>	<b>5.35</b>
1 1/2"	1 1/4"	<b>62281</b>	<b>5.35</b>
2"	3/4"	<b>62195</b>	<b>6.15</b>
2"	1"	<b>62196</b>	<b>6.15</b>
2"	1 1/4"	<b>62197</b>	<b>6.15</b>
2"	1 1/2"	<b>62198</b>	<b>6.15</b>
3"	2"	<b>60330</b>	<b>18.50</b>



Tuff-Lite™ - Male NPT x Female Threaded Swivel Nut Adapters

- female shipped with a red vinyl washer (**TVW7**), replacement washers on page E-47

Male NPT	Female Thread	Nylon	
		Part #	Price/E
1/4"	3/4" GHT	<b>TSA72</b>	<b>\$1.90</b>
3/8"	3/4" GHT	<b>TSA73</b>	<b>1.95</b>
1/4"	3/4" NPS	<b>TSA62</b>	<b>1.90</b>
3/8"	3/4" NPS	<b>TSA63</b>	<b>2.00</b>



Tuff-Lite™ - Reducing Bushings

Male NPT	Female NPT	Nylon	
		Part #	Price/E
3/8"	1/4"	<b>THB32</b>	<b>\$1.90</b>
1/2"	1/4"	<b>THB42</b>	<b>2.00</b>
1/2"	3/8"	<b>THB43</b>	<b>2.00</b>
3/4"	1/2"	<b>THB64</b>	<b>2.35</b>
1"	3/4"	<b>THB86</b>	<b>3.20</b>



• For additional information on pipe dimensions please reference [dixonvalve.com](http://dixonvalve.com).

## Tuff-Lite™ - Close Nipples

- sold in package quantity only



Male NPT	Part #	Nylon	
		Price/E	Pkg Qty
1/4"	<b>TCN202</b>	<b>\$0.72</b>	50
3/8"	<b>TCN303</b>	<b>0.81</b>	50
1/2"	<b>TCN404</b>	<b>0.93</b>	50
3/4"	<b>TCN606</b>	<b>1.10</b>	50

## Polypropylene Schedule 80 - Hex Nipples



Male NPT	Part #	Polypropylene	
		Price/E	
1/2"	<b>62221</b>	<b>\$1.90</b>	
3/4"	<b>60554</b>	<b>3.05</b>	
1"	<b>60555</b>	<b>3.60</b>	
1 1/4"	<b>60556</b>	<b>3.70</b>	
1 1/2"	<b>60547</b>	<b>5.25</b>	
2"	<b>60548</b>	<b>5.90</b>	
3"	<b>61769</b>	<b>20.00</b>	

## Polypropylene Schedule 80 - Reducer Nipples



Male NPT	Male NPT	Polypropylene	
		Part #	Price/E
3/4"	1/2"	<b>62233</b>	<b>\$2.90</b>
1"	3/4"	<b>62234</b>	<b>3.35</b>
1 1/4"	1"	<b>62235</b>	<b>3.90</b>
1 1/2"	1 1/4"	<b>62236</b>	<b>4.25</b>
2"	1 1/2"	<b>60549</b>	<b>5.05</b>

## Polypropylene Schedule 80 - Nipples



Male NPT	Length	Polypropylene	
		Part #	Price/E
3/4"	4"	<b>62223</b>	<b>\$3.60</b>
3/4"	6"	<b>62224</b>	<b>4.40</b>
1"	4"	<b>62225</b>	<b>3.85</b>
1"	6"	<b>62226</b>	<b>4.80</b>
2"	4"	<b>62192</b>	<b>12.60</b>
2"	6"	<b>62193</b>	<b>14.50</b>

- For additional information on pipe dimensions please reference [dixonvalve.com](http://dixonvalve.com).

Polypropylene Schedule 80 - 90° Elbows

Female NPT	Polypropylene	
	Part #	Price/E
1/2"	<b>62215</b>	<b>\$4.90</b>
3/4"	<b>62216</b>	<b>5.60</b>
1"	<b>62217</b>	<b>6.50</b>
1 1/2"	<b>62219</b>	<b>12.90</b>
2"	<b>62191</b>	<b>15.50</b>
3"	<b>62220</b>	<b>74.00</b>



Tuff-Lite™ - Street Female NPT x 90° Male NPT Elbows

Female NPT	Male NPT	Nylon	
		Part #	Price/E
1/4"	1/4"	<b>TSE22</b>	<b>\$4.05</b>
1/2"	1/2"	<b>TSE44</b>	<b>3.90</b>
3/4"	3/4"	<b>TSE66</b>	<b>5.30</b>



Polypropylene Schedule 80 - 90° Street Elbows

NPT Thread	Polypropylene	
	Part #	Price/E
1/2"	<b>62243</b>	<b>\$5.20</b>
3/4"	<b>62244</b>	<b>5.60</b>
1"	<b>62245</b>	<b>6.50</b>
1 1/4"	<b>62246</b>	<b>8.60</b>
1 1/2"	<b>62247</b>	<b>13.20</b>
2"	<b>62199</b>	<b>15.90</b>
3"	<b>62248</b>	<b>74.00</b>



Polypropylene Schedule 80 - Tees

Female NPT	Polypropylene	
	Part #	Price/E
1/2"	<b>62209</b>	<b>\$5.85</b>
3/4"	<b>62210</b>	<b>6.10</b>
1"	<b>62211</b>	<b>8.50</b>
1 1/4"	<b>62212</b>	<b>10.20</b>
1 1/2"	<b>62213</b>	<b>16.00</b>
2"	<b>62190</b>	<b>19.25</b>
3"	<b>62214</b>	<b>84.00</b>



Polypropylene Schedule 80 - Cross

Female NPT	Polypropylene	
	Part #	Price/E
1"	<b>62263</b>	<b>\$25.25</b>



• For additional information on pipe dimensions please reference [dixonvalve.com](http://dixonvalve.com).

Tuff-Lite™ - Female Threaded Swivel Nuts



Female Thread	Part #	Nylon	Price/E
3/4" NPSM	<b>TCF6</b>		<b>\$0.66</b>
3/4" GHT	<b>TCF7</b>		<b>0.62</b>

Tuff-Lite™ - Threaded Caps

- sold in package quantity only



Female Thread	Part #	Nylon	Price/E	Pkg Qty
1/4" NPT	<b>TTC2</b>		<b>\$0.48</b>	50
3/8" NPT	<b>TTC3</b>		<b>0.57</b>	50
1/2" NPT	<b>TTC4</b>		<b>0.71</b>	50
3/4" NPT	<b>TTC6</b>		<b>0.80</b>	50
3/4" GHT	<b>TTC7</b>		<b>0.80</b>	50

Tuff-Lite™ - Hex Head Drain Plugs

- sold in package quantity only



Male NPT	Part #	Nylon	Price/E	Pkg Qty
1/8"	<b>TPX1</b>		<b>\$0.64</b>	50
1/4"	<b>TPX2</b>		<b>0.68</b>	50
3/8"	<b>TPX3</b>		<b>0.71</b>	50
1/2"	<b>TPX4</b>		<b>0.82</b>	50
3/4"	<b>TPX6</b>		<b>0.96</b>	50
1"	<b>TPX8</b>		<b>1.17</b>	50
1 1/4"	<b>TPX10</b>		<b>1.55</b>	25

Tuff-Lite™ - Square Head Drain Plugs

- sold in package quantity only



Male NPT	Part #	Nylon	Price/E	Pkg Qty
1/8"	<b>TPS1</b>		<b>\$0.55</b>	50
1/4"	<b>TPS2</b>		<b>0.57</b>	50
3/8"	<b>TPS3</b>		<b>0.68</b>	50
1/2"	<b>TPS4</b>		<b>0.76</b>	50
3/4"	<b>TPS6</b>		<b>0.90</b>	50
1"	<b>TPS8</b>		<b>1.12</b>	50
1 1/4"	<b>TPS10</b>		<b>1.67</b>	25

Polypropylene Schedule 80 - Pipe Caps



Female NPT	Part #	Polypropylene	Price/E
3/4"	<b>62250</b>		<b>\$6.75</b>
1"	<b>62251</b>		<b>6.75</b>

Polypropylene Schedule 80 - Pipe Plugs



Male NPT	Part #	Polypropylene	Price/E
3/4"	<b>62256</b>		<b>\$3.35</b>
1"	<b>62257</b>		<b>3.35</b>
1 1/4"	<b>62258</b>		<b>3.70</b>
1 1/2"	<b>62259</b>		<b>5.90</b>
2"	<b>62201</b>		<b>6.25</b>

- For additional information on pipe dimensions please reference [dixonvalve.com](http://dixonvalve.com).



Bulkhead Fittings

**Application:**

- for use on most poly storage tanks and many steel and fiberglass tanks

**Features:**

- glass reinforced polypropylene provides strength and chemical resistance
- EPDM gaskets are standard
- FKM gaskets are available, contact Dixon® to order

Pipe, Welding  
& Tube Fittings

**female NPT fittings**

Female NPT	Hole Size	Polypropylene	
		Part #	Price/E
1/2"	1-7/16"	<b>62834</b>	<b>\$12.20</b>
3/4"	1-7/16"	<b>60401</b>	<b>9.75</b>
1"	2-1/4"	<b>60427</b>	<b>12.20</b>
1 1/4"	2-1/4"	<b>60403</b>	<b>12.20</b>
1 1/2"	2-3/8"	<b>63931</b> <sup>1</sup>	<b>14.50</b>
2"	3"	<b>60405</b>	<b>17.50</b>
2"	3"	<b>63481</b> <sup>2</sup>	<b>14.90</b>
2" HD <sup>3</sup>	3-1/4"	<b>63683</b>	<b>27.50</b>
3"	4-1/2"	<b>62299</b> <sup>1</sup>	<b>86.50</b>



<sup>1</sup> 1 1/2" and 3" do not contain a washer  
<sup>2</sup> designed for tank wall thickness less than 3/8" - low profile

**Gaskets**

Size	EPDM	
	Part #	Price/E
1/2" - 3/4"	<b>60402</b>	<b>\$2.15</b>
1" - 1 1/4"	<b>60404</b>	<b>3.05</b>
1 1/2"	<b>63938</b>	<b>6.55</b>
2"	<b>60406</b>	<b>4.15</b>
2" HD <sup>3</sup>	<b>60336</b>	<b>6.45</b>
3"	<b>60331</b>	<b>16.55</b>



<sup>3</sup> heavy duty

**Bulkhead Couplings**

Female NPTF	External Male UNS	Length	Brass	
			Part #	Price/E
1/8"	5/8"	1.50"	<b>207BH2</b>	<b>\$10.26</b>
1/4"	3/4"	1.50"	<b>207BH4</b>	<b>11.97</b>
1/4"	3/4"	.94"	<b>207BH4S</b>	<b>9.65</b>
3/8"	1"	1.31"	<b>207BH6</b>	<b>15.15</b>
1/2"	1-1/8"	1.50"	<b>207BH8</b>	<b>20.60</b>
3/4"	1-5/16"	1.50"	<b>207BH12</b>	<b>107.90</b>



## Bolted Fittings

## Polypropylene Female NPT fittings

## Features:

- Bolts thread into back plate of fitting leaving no welds, holes as potential points of leakage.
- 316 stainless steel bolts
- 2 required, EPDM gaskets are standard (sold separately)
- FKM gaskets are available, contact Dixon®



Size	Polypropylene	
	Part #	Price/E
3/4"	<b>60502</b>	<b>\$43.40</b>
1"	<b>60505</b>	<b>43.40</b>
1 1/2"	<b>60513</b>	<b>74.00</b>
2"	<b>60516</b>	<b>74.00</b>

## Gaskets



Size	EPDM	
	Part #	Price/E
3/4" - 1"	<b>60498</b>	<b>\$6.00</b>
1 1/2" - 2"	<b>60497</b>	<b>5.95</b>

## Stainless Steel Female NPT fittings

## Features:

- Bolts thread into back plate of fitting leaving no welds, holes as potential points of leakage.
- 316 stainless steel bolts
- required, cross-linked polyethylene gaskets are standard (*sold separately*)
- FKM and EPDM gaskets are available, contact Dixon®



Size	Stainless Steel	
	Part #	Price/E
3/4"	<b>63035</b>	<b>\$134.30</b>
1"	<b>62948</b>	<b>137.70</b>
1 1/2"	<b>63037</b>	<b>192.00</b>
2"	<b>63038</b>	<b>203.30</b>

## Gaskets



Size	Cross-Linked Polyethylene	
	Part #	Price/E
3/4" - 1"	<b>62950</b>	<b>\$4.90</b>
1 1/2"	<b>63042</b>	<b>9.40</b>
2"	<b>62848</b>	<b>10.45</b>

Swage Nipples

Features:

- manufactured in conformance with ASTM A234 and MSS SP-95
- threads on nipples conform to ASME B1.20.1
- schedule 40 nipples have blue caps
- schedule 80 nipples have green caps

Male NPT	Length	Zinc Plated Schedule 40	
		Part #	Price/E
2" x 1"	6.5"	SW40-200100	\$35.15
2" x 1¼"	6.5"	SW40-200125	35.15
2" x 1½"	6.5"	SW40-200150	35.15
2½" x 1"	7"	SW40-250100	47.10
2½" x 1½"	7"	SW40-250150	47.10
2½" x 2"	7"	SW40-250200	38.65
3" x 2"	8"	SW40-300200	43.20
3" x 2½"	8"	SW40-300250	43.20
4" x 2"	9"	SW40-400200	74.35
4" x 2½"	9"	SW40-400250	75.75
4" x 3"	9"	SW40-400300	62.75
6" x 3"	12"	SW40-600300	242.45
6" x 4"	12"	SW40-600400	231.30
8" x 4"	13"	SW40-800400	643.05
8" x 6"	13"	SW40-800600	491.80



Pipe, Welding  
& Tube Fittings

Male NPT	Length	Zinc Plated Schedule 80	
		Part #	Price/E
½" x ¼"	2.8"	SW80-050025	\$11.15
½" x ⅜"	2.8"	SW80-050038	11.80
¾" x ½"	3.0"	SW80-075050	13.10
1" x ¼"	3.5"	SW80-100025	14.75
1" x ½"	3.5"	SW80-100050	13.95
1" x ¾"	3.5"	SW80-100075	16.95
2" x ½"	6.5"	SW80-200050	40.95
2" x ¾"	6.5"	SW80-200075	38.80
2" x 1"	6.5"	SW80-200100	34.55
2" x 1¼"	6.5"	SW80-200125	35.15
2" x 1½"	6.5"	SW80-200150	35.15
2½" x 2"	7.0"	SW80-250200	40.35
3" x 1"	8.0"	SW80-300100	77.85
3" x 2"	8.0"	SW80-300200	57.25
3" x 2½"	8.0"	SW80-300250	54.05
4" x 2"	9.0"	SW80-400200	89.55
4" x 3"	9.0"	SW80-400300	83.60
4" x 4"	9.0"	SW80-400400	119.25
6" x 3"	12.0"	SW80-600300	286.05
6" x 4"	12.0"	SW80-600400	279.55
8" x 6"	13.0"	SW80-800600	571.05



• For additional information on pipe dimensions please reference [dixonvalve.com](http://dixonvalve.com).



schedule 80

### Bull Plugs

**Features:**

- manufactured in conformance with ASTM A234 and MSS SP-95
- threads on nipples conform to ASME B1.20.1
- schedule 40 nipples have blue caps
- schedule 80 nipples have green caps

Male NPT	Length	Zinc Plated Schedule 40		Zinc Plated Schedule 80	
		Part #	Price/E	Part #	Price/E
2"	4"	<b>BP40-200</b>	<b>\$30.40</b>	<b>BP80-200</b>	<b>\$29.90</b>
2½"	5"	<b>BP40-250</b>	<b>52.05</b>	<b>BP80-250</b>	<b>54.70</b>
3"	6"	<b>BP40-300</b>	<b>65.10</b>	<b>BP80-300</b>	<b>59.75</b>
4"	7"	<b>BP40-400</b>	<b>89.65</b>	<b>BP80-400</b>	<b>81.90</b>

### Bull Plugs with Tap



schedule 40

**Features:**

- manufactured in conformance with ASTM A234 and MSS SP-95
- threads on nipples conform to ASME B1.20.1
- schedule 40 nipples have blue caps
- schedule 80 nipples have green caps

Male NPT	Length	Zinc Plated Schedule 40		Zinc Plated Schedule 80	
		Part #	Price/E	Part #	Price/E
2" x ¼"	4"	<b>BP40-200T025</b>	<b>\$31.80</b>	<b>BP80-200T025</b>	<b>\$31.80</b>
2" x ½"	5"	<b>BP40-200T050</b>	<b>31.80</b>	<b>BP80-200T050</b>	<b>33.35</b>
3" x ½"	6"	<b>BP40-300T050</b>	<b>64.20</b>	<b>BP80-300T050</b>	<b>69.35</b>
4" x ½"	7"	<b>BP40-400T050</b>	<b>90.95</b>	<b>BP80-400T050</b>	<b>95.70</b>

• For additional information on pipe dimensions please reference [dixonvalve.com](http://dixonvalve.com).

Hammer Unions

**Features:**

- Socket weld configurations and other materials are available, contact Dixon® for further information.
- Hammer unions work at extremely high pressures. Mismatching components of one series with another (i.e. series 602 with series 1502) can lead to destruction of property, serious bodily injury or death.
- temperature range: **-20°F to 250°F (-29°C to 121°C)**
- non-shocking cold water pressure means that the rated value is the maximum operating pressure at ambient temperature
- no spikes higher than this pressure
- no instantaneous pressure increases (0-2000 PSIG in ¼ of a second)
- ambient temperature: **70°F (21°C)**



**100 Series**

**Features:**

- used on low pressure manifolds and lines and in applications running air, water, oil or gas up to **1,000 PSI NSCWP** (non-shock cold working pressure)
- yellow sub, black nut

Size	Configuration	NSCWP (PSI)	Forged Steel	
			Part #	Price/E
2"	threaded	1000	HU100200	\$52.90
2"	butt weld	1000	HU100200BW <sup>1</sup>	82.35
2½"	threaded	1000	HU100250	150.00
3"	threaded	1000	HU100300	139.05
4"	threaded	1000	HU100400	209.45
4"	butt weld	1000	HU100400BW <sup>1</sup>	272.70
6"	threaded	1000	HU100600	722.40
8"	threaded	1000	HU100800	981.65

<sup>1</sup> butt weld ends are schedule 40



**200 Series**

**Features:**

- used in general service applications running air, water, oil or gas up to **2,000 PSI NSCWP** (non-shock cold working pressure)
- grey sub, blue nut

Size	Configuration	NSCWP (PSI)	Forged Steel	
			Part #	Price/E
1"	threaded	2000	HU200100	\$35.35
1½"	threaded	2000	HU200150	116.15
2"	threaded	2000	HU200200	51.90
2"	butt weld	2000	HU200200BW <sup>1</sup>	87.10
2½"	threaded	2000	HU200250	229.60
3"	threaded	2000	HU200300	213.75
4"	threaded	2000	HU200400	271.80
6"	threaded	2000	HU200600	981.65
8"	threaded	2000	HU200800	1150.00

<sup>1</sup> butt weld ends are schedule 40



**206 Series**

**Features:**

- used in general service applications running air, water, oil and gas up to **2,000 PSI NSCWP** (non-shock cold working pressure)
- O-ring mounted sub provides excellent sealing properties
- grey sub, blue nut

Size	Configuration	NSCWP (PSI)	Forged Steel	
			Part #	Price/E
1"	threaded	2000	HU206100	\$39.15
1½"	threaded	2000	HU206150	101.10
2"	threaded	2000	HU206200	60.20
2½"	threaded	2000	HU206250	224.80
3"	threaded	2000	HU206300	224.30
4"	threaded	2000	HU206400	250.00
6"	threaded	2000	HU206600	1066.10
8"	threaded	2000	HU206800	1600.00



## Hammer Unions

## 400 Series

**Features:**

- used on manifold and line connections, pump, suction and mud service
- up to **4,000 PSI NSCWP** (non-shock cold working pressure)
- red sub, black nut

Size	Configuration	NSCWP (PSI)	Forged Steel	
			Part #	Price/E
2"	threaded	<b>4000</b>	<b>HU400200</b>	<b>\$148.00</b>
3"	threaded	<b>4000</b>	<b>HU400300</b>	<b>305.25</b>
4"	threaded	<b>4000</b>	<b>HU400400</b>	<b>387.45</b>

## 602 Series

**Features:**

- for use in mud, manifold service and truck mounting applications running water, oil or mud up to **6,000 PSI NSCWP** (non-shock cold working pressure)
- lip type seal ring minimizes fluid flow turbulence while creating a pressure seal
- orange sub, black nut



Size	Configuration	NSCWP (PSI)	Forged Steel	
			Part #	Price/E
1"	threaded	<b>6000</b>	<b>HU602100</b>	<b>\$116.00</b>
2"	threaded	<b>6000</b>	<b>HU602200</b>	<b>269.20</b>
2"	buttweld	<b>6000</b>	<b>HU602200BW<sup>1</sup></b>	<b>234.85</b>
3"	threaded	<b>6000</b>	<b>HU602300</b>	<b>375.00</b>
3"	buttweld	<b>6000</b>	<b>HU602300BW<sup>1</sup></b>	<b>446.15</b>
4"	threaded	<b>6000</b>	<b>HU602400</b>	<b>550.00</b>
4"	buttweld	<b>6000</b>	<b>HU602400BW<sup>1</sup></b>	<b>704.50</b>

<sup>1</sup> buttweld ends are schedule 80

## 1002 Series

**Features:**

- for use in high pressure systems and truck mounting applications running water, oil or mud up to **10,000 PSI NSCWP** (non-shock cold working pressure)
- lip type seal ring minimizes fluid flow turbulence while creating a pressure seal
- blue sub, red nut



Size	Configuration	NSCWP (PSI)	Forged Steel	
			Part #	Price/E
1"	threaded	<b>10000</b>	<b>HU1002100</b>	<b>\$223.15</b>
2"	threaded	<b>10000</b>	<b>HU1002200</b>	<b>293.40</b>
2"	buttweld	<b>10000</b>	<b>HU1002200BW<sup>1</sup></b>	<b>270.00</b>
3"	threaded	<b>10000</b>	<b>HU1002300</b>	<b>450.00</b>
3"	buttweld	<b>10000</b>	<b>HU1002300BW<sup>1</sup></b>	<b>610.55</b>
4"	threaded	<b>10000</b>	<b>HU1002400</b>	<b>758.20</b>
4"	buttweld	<b>10000</b>	<b>HU1002400BW<sup>1</sup></b>	<b>751.45</b>

<sup>1</sup> buttweld ends are schedule XXS



Hammer Unions

1502 Series

Features:

- for use in extreme high pressure applications running water, oil or mud up to **15,000 PSI** NSCWP (non-shock cold working pressure)
- lip type seal ring minimizes fluid flow turbulence while creating a pressure seal
- red sub, blue nut

Size	Configuration	NSCWP (PSI)	Forged Steel	
			Part #	Price/E
2"	threaded	<b>15000</b>	<b>HU1502200</b>	<b>\$303.85</b>
2"	buttweld	<b>15000</b>	<b>HU1502200BW<sup>1</sup></b>	<b>352.25</b>
3"	threaded	<b>15000</b>	<b>HU1502300</b>	<b>670.00</b>
3"	buttweld	<b>15000</b>	<b>HU1502300BW<sup>1</sup></b>	<b>730.30</b>
4"	threaded	<b>15000</b>	<b>HU1502400</b>	<b>1060.50</b>
4"	buttweld	<b>15000</b>	<b>HU1502400BW<sup>1</sup></b>	<b>1268.05</b>



Pipe, Welding  
& Tube Fittings

<sup>1</sup> buttweld ends are schedule XXS

Hookie - Hook Hose Lifter

Features:

- for use with hammer unions on pages J-29 - J-31
- safe working load is 4 tons, with a proof load test of 8 tons
- supplied complete with retaining clamp

Size	Forged Steel	
	Part #	Price/E
3"	<b>HA0900-3</b>	<b>\$666.60</b>
4"	<b>HA0900-4</b>	<b>666.60</b>
5"	<b>HA0900-5</b>	<b>727.20</b>



NPT Threaded Pipe Fittings



Size	Overall Length	Carbon Steel		304 Stainless Steel		Aluminum	
		Part #	Price/E	Part #	Price/E	Part #	Price/E
1/4"	2"	<b>PN250</b>	<b>\$4.95</b>	<b>PNS250</b>	<b>\$7.80</b>	---	---
3/8"	2"	<b>PN375</b>	<b>5.50</b>	<b>PNS375</b>	<b>9.95</b>	---	---
1/2"	2"	<b>PN500</b>	<b>4.90</b>	<b>PNS500</b>	<b>11.20</b>	---	---
3/4"	2"	<b>PN750</b>	<b>3.50</b>	<b>PNS750</b>	<b>13.90</b>	---	---
1"	2"	<b>PN1000</b>	<b>5.05</b>	<b>PNS1000</b>	<b>16.70</b>	---	---
1 1/4"	2"	<b>PN1250</b>	<b>7.15</b>	<b>PNS1250</b>	<b>20.85</b>	---	---
1 1/2"	2"	<b>PN1500</b>	<b>6.15</b>	<b>PNS1500</b>	<b>23.70</b>	---	---
2"	2"	<b>PN2000</b>	<b>7.15</b>	<b>PNS2000</b>	<b>33.65</b>	---	---
2 1/2"	3"	<b>PN2500</b>	<b>24.25</b>	<b>PNS2500</b>	<b>78.25</b>	---	---
3"	3"	<b>PN3000</b>	<b>28.00</b>	<b>PNS3000</b>	<b>105.80</b>	<b>APN3000</b>	<b>\$43.25</b>
4"	4"	<b>PN4000</b>	<b>46.00</b>	<b>PNS4000</b>	<b>161.35</b>	<b>APN4000</b>	<b>64.15</b>

Dixon® Hex Nipples for Welding to Metal Hose



carbon steel



machined brass



global stainless

Size	Carbon Steel <sup>1</sup>		Optional Qty	Machined Brass	
	Part #	Price/E		Part #	Price/E
1/4"	<b>FM250</b>	<b>\$3.50</b>	200	<b>FMB250</b>	<b>\$7.00</b>
3/8"	<b>FM375</b>	<b>3.65</b>	100	<b>FMB375</b>	<b>11.15</b>
1/2"	<b>FM500</b>	<b>4.55</b>	50	<b>FMB500</b>	<b>13.90</b>
3/4"	<b>FM750</b>	<b>5.55</b>	50	<b>FMB750</b>	<b>15.60</b>
1"	<b>FM1000</b>	<b>7.30</b>	50	<b>FMB1000</b>	<b>25.90</b>
1 1/4"	<b>FM1250</b>	<b>15.00</b>	50	---	---
1 1/2"	<b>FM1500</b>	<b>15.85</b>	50	---	---
2"	<b>FM2000</b>	<b>39.90</b>	10	---	---

Size	304 Stainless Steel <sup>1</sup>		Optional Qty	316 Stainless Steel <sup>1</sup>	
	Part #	Price/E		Part #	Price/E
1/4"	<b>FMS250</b>	<b>\$9.50</b>	200	---	---
3/8"	<b>FMS375</b>	<b>11.85</b>	100	---	---
1/2"	<b>FMS500<sup>2</sup></b>	<b>11.20</b>	50	<b>FMR500<sup>2</sup></b>	<b>\$12.75</b>
3/4"	<b>FMS750<sup>2</sup></b>	<b>12.60</b>	50	<b>FMR750<sup>2</sup></b>	<b>16.45</b>
1"	<b>FMS1000<sup>2</sup></b>	<b>19.50</b>	50	<b>FMR1000<sup>2</sup></b>	<b>28.20</b>
1 1/4"	<b>FMS1250</b>	<b>60.60</b>	50	---	---
1 1/2"	<b>FMS1500</b>	<b>60.80</b>	50	<b>FMR1500</b>	<b>63.10</b>

<sup>1</sup> Dixon® suggests using 308 LSI welding rod

<sup>2</sup> global stainless steel

Dixon® Octagonal Nipples for Welding to Metal Hose



Size	Overall Length	Weld-On Length	Hex Length	Carbon Steel		304 Stainless Steel	
				Part #	Price/E	Part #	Price/E
2"	2 1/2"	7/8"	9/16"	<b>OCTOE32</b>	<b>\$28.35</b>	<b>OCTOES32</b>	<b>\$53.85</b>

• For additional information on pipe dimensions please reference [dixonvalve.com](http://dixonvalve.com).

## Wrench Grips



### Dixon® Octagonal Wrench Grips

Size	Across Outside Flats	Across Inside Flats	Width	304 Stainless Steel	
				Part #	Price/E
1½"	2.230"	1.910"	9/16"	<b>OCTS24</b>	<b>\$14.30</b>
2"	2.781"	2.385"	9/16"	<b>OCTS32</b>	<b>16.85</b>
3"	3.750"	3.510"	7/8"	<b>OCTS48</b>	<b>37.70</b>

Size	Across Outside Flats	Across Inside Flats	Width	304 Stainless Steel	
				Part #	Price/E
2"	2.740"	2.510"	9/16"	<b>OCT32</b>	<b>\$9.40</b>



Pipe, Welding  
& Tube Fittings

### Dixon® Weld-On Hex Wrench Grips

Size	Global Investment Cast Steel	
	Part #	Price/E
1"	<b>WN12</b>	<b>\$6.30</b>
1¼"	<b>WN16</b>	<b>5.90</b>
1½"	<b>WN21</b>	<b>5.90</b>
2"	<b>WN26</b>	<b>6.45</b>
2½"	<b>WN31</b>	<b>8.60</b>
3"	<b>WN36</b>	<b>10.40</b>
4"	<b>WN46</b>	<b>21.00</b>



## Straub Grip-L Axial Restraint Pipe Couplings

**Application:**

- suitable for pipes within the lower pressure range, applications include, but are not limited to: ship building, water and waste water treatment plants and industrial process pipe work

**Features:**

- joins like or dissimilar pipe materials: steel, galvanized, painted, stainless steel, thin-wall stainless steel, PVC, copper
- requires no special tools or pipe-end preparation; only a torque wrench is required for a secure and safe pipe connection that seldom needs retightening
- accommodates up to 5° of pipe misalignment
- vary gap between pipe ends
- absorbs vibration, water hammer and sound
- special patented grip ring for superior holding power on hard-surfaced pipes
- 5 year limited warranty
- reusable
- EPDM sealing sleeve temperature range: - 4°F to 176°F (-20°C to 80°C)
- NBR and FKM sleeves available, contact Dixon® for information



**Materials:**

- casing: AISI 316Ti; screws: AISI 316 L; bolts: AISI 316 Ti; anchoring ring: AISI 301; sealing sleeve: EPDM standard

**Specifications:**

- American Bureau of Shipping (ABS) up to **232 PSI** on ¾" - 5"; **188 PSI** on 6"; **145 PSI** on 8"
- Underwriter's Laboratories (UL)
- National Sanitation Foundation (NSF)
- built to ASTM 1476, Type 2, Class 2 specifications

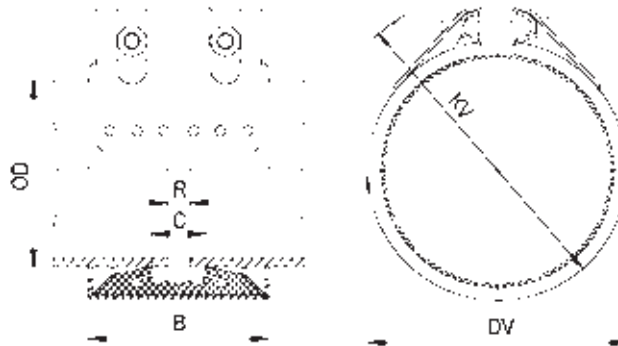

Size	Pipe OD Range		Working Pressure PSI	Coupling Dimensions		Assembled Dimensions		Maximum Distance Between Pipe End R	316 Ti Stainless Steel	
	actual	min to max		B	C	DV	KV		Part #	Price/E
¾"	1.05"	1.04" to 1.08"	<b>670</b>	1.8"	0.7"	1.7"	2.8"	0.2"	<b>STR20000</b> <sup>1</sup>	<b>\$169.30</b>
1"	1.31"	1.31" to 1.35"	<b>550</b>	1.8"	0.7"	2.0"	3.0"	0.2"	<b>STR20100</b> <sup>1</sup>	<b>179.30</b>
1½"	1.90"	1.88" to 1.92"	<b>440</b>	2.4"	1.0"	2.6"	3.9"	0.2"	<b>STR20300</b> <sup>1</sup>	<b>221.95</b>
2"	2.37"	2.35" to 2.40"	<b>320</b>	3.0"	1.5"	3.1"	4.3"	0.4"	<b>STR20450</b> <sup>1</sup>	<b>259.90</b>
2½"	2.87"	2.85" to 2.90"	<b>450</b>	3.7"	1.6"	3.9"	5.3"	0.4"	<b>STR20500</b>	<b>331.35</b>
3"	3.50"	3.46" to 3.54"	<b>320</b>	3.7"	1.6"	4.4"	5.9"	0.4"	<b>STR20650</b>	<b>365.00</b>
4"	4.50"	4.46" to 4.54"	<b>232</b>	3.7"	1.6"	5.4"	6.7"	0.4"	<b>STR20900</b>	<b>403.65</b>
5"	5.50"	5.51" to 5.62"	<b>232</b>	4.3"	2.1"	6.5"	8.3"	0.4"	<b>STR21150</b>	<b>598.10</b>
6"	6.63"	6.56" to 6.69"	<b>232</b>	4.3"	2.1"	7.6"	9.1"	0.4"	<b>STR21350</b>	<b>650.45</b>
8"	8.63"	8.54" to 8.71"	<b>232</b>	5.6"	3.1"	9.8"	11.6"	0.4"	<b>STR21400</b>	<b>1136.50</b>

<sup>1</sup> only has one bolt

Note: All Straub couplings require the correct use of a torque wrench for a safe and proper installation. Straub couplings must be torqued to the specified value as printed on each individual coupling. Failure to do so can result in serious injury or death.

**Not for steam or refrigerant service.**



## Straub Open-Flex 1L Couplings

**Applications:**

- suitable for repairing or joining pipes where access to the pipe end is difficult or impossible

**Features:**

- use to replace bolted sleeve type couplings (AWWA Std. C-219) or for permanent repairs or installation
- wrap-around design differs from similar type repair products because the installation or repair is permanent due to the unique flexible lip seal gasket design
- joins like or dissimilar pipe materials: steel, galvanized, painted, stainless steel, thin-wall stainless steel, PVC, copper
- requires no special tools or pipe-end preparation; only a torque wrench is required for a secure and safe pipe connection that seldom needs retightening
- accommodates up to 5° of pipe misalignment
- vary gap between pipe ends
- absorbs vibration, water hammer, and sound
- acts as an expansion joint; will accept up to .25" of axial movement
- EPDM sealing sleeve temperature range: - 4°F to 176°F (-20°C to 80°C)
- 5 year limited warranty
- reusable

**Materials:**

- casing: AISI 316Ti; screws: AISI 4135 steel; bolts: AISI 12L 14 galvanized

**Specifications:**

- American Bureau of Shipping (ABS) up to 232 PSI
- Underwriter's Laboratories (UL)
- National Sanitation Foundation (NSF)
- conforms to ASTM 1476, Type 2, Class 3 specifications

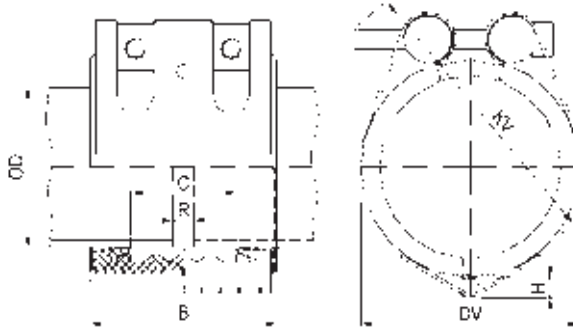

Size	Pipe OD Range		Working Pressure PSI	Coupling Dimensions			Assembled Dimensions		Maximum Distance Between Pipe End R	316 Ti Stainless Steel	
	actual	min to max		B	C	H	DV	KV		Part #	Price/E
1½"	1.90"	1.85" to 1.95"	363	3.0"	1.4"	.28"	2.8"	3.3"	.20"	STR35001	\$268.95
2"	2.38"	2.32" to 2.42"	232	3.0"	1.4"	.28"	3.2"	3.7"	.20"	STR35151	284.95
2½"	2.88"	2.81" to 2.93"	232	3.0"	1.4"	.36"	3.2"	3.7"	.20"	STR35201	310.00
3"	3.50"	3.44" to 3.56"	232	3.7"	2.0"	.36"	4.4"	4.9"	.20"	STR35351	324.95
4"	4.50"	4.43" to 4.57"	232	3.7"	2.0"	.36"	5.4"	5.9"	.20"	STR35651	343.65
5"	5.56"	5.49" to 5.57"	232	4.2"	2.4"	.38"	6.4"	7.1"	.20"	STR35901	433.80
6"	6.63"	6.54" to 6.71"	232	4.2"	2.4"	.38"	7.5"	8.1"	.20"	STR36051	464.80

**⚠ Note: Not pull-out resistant.** Ensure that pipes are properly anchored and supported.

### Assembly Tool

Part #	Price/E
STR6648	\$348.55



150 Lb. ASA Forged Lap Joint Flanges

Features:

- no raised face
- The lap joint flange is commonly called a Van Stone or a floating flange.



Size	Number of Bolts	Carbon Steel		316 Stainless Steel	
		Part #	Price/E	Part #	Price/E
1"	4	<b>LJ100</b>	<b>\$35.00</b>	---	---
1¼"	4	<b>LJ125</b>	<b>35.00</b>	---	---
1½"	4	<b>LJ150</b>	<b>26.00</b>	<b>LJR150</b>	<b>\$75.00</b>
2"	4	<b>LJ200</b>	<b>27.55</b>	<b>LJR200</b>	<b>125.00</b>
2½"	4	<b>LJ250</b>	<b>60.00</b>	---	---
3"	4	<b>LJ300</b>	<b>45.00</b>	<b>LJR300</b>	<b>190.00</b>
4"	8	<b>LJ400</b>	<b>62.00</b>	<b>LJR400</b>	<b>275.00</b>
5"	8	<b>LJ500</b>	<b>78.00</b>	---	---
6"	8	<b>LJ600</b>	<b>89.00</b>	<b>LJR600</b>	<b>430.00</b>
8"	8	<b>LJ800</b>	<b>158.00</b>	---	---
10"	12	<b>LJ1000</b>	<b>196.00</b>	---	---
12"	12	<b>LJ1200</b>	<b>325.00</b>	---	---

150 Lb. ASA Forged Slip-On Flanges

Feature:

- raised face



Size	Number of Bolts	Carbon Steel		316 Stainless Steel	
		Part #	Price/E	Part #	Price/E
1"	4	<b>SO100</b>	<b>\$22.05</b>	---	---
1¼"	4	<b>SO125</b>	<b>28.00</b>	---	---
1½"	4	<b>SO150</b>	<b>24.50</b>	<b>SOR150</b>	<b>\$78.00</b>
2"	4	<b>SO200</b>	<b>26.00</b>	<b>SOR200</b>	<b>102.00</b>
2½"	4	<b>SO250</b>	<b>41.00</b>	---	---
3"	4	<b>SO300</b>	<b>41.00</b>	<b>SOR300</b>	<b>170.00</b>
4"	8	<b>SO400</b>	<b>58.00</b>	<b>SOR400</b>	<b>225.00</b>
5"	8	<b>SO500</b>	<b>90.15</b>	---	---
6"	8	<b>SO600</b>	<b>79.00</b>	<b>SOR600</b>	<b>350.00</b>
8"	8	<b>SO800</b>	<b>133.00</b>	---	---
10"	12	<b>SO1000</b>	<b>182.00</b>	---	---
12"	12	<b>SO1200</b>	<b>288.00</b>	---	---

150 Lb. ASA Forged NPT Threaded Flanges

Feature:

- raised face

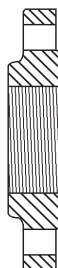

Size	Number of Bolts	Carbon Steel		316 Stainless Steel	
		Part #	Price/E	Part #	Price/E
1"	4	<b>T100</b>	<b>\$44.00</b>	---	---
1¼"	4	<b>T125</b>	<b>43.00</b>	---	---
1½"	4	<b>T150</b>	<b>39.00</b>	<b>TR150</b>	<b>\$99.00</b>
2"	4	<b>T200</b>	<b>42.00</b>	<b>TR200</b>	<b>135.00</b>
2½"	4	<b>T250</b>	<b>49.00</b>	---	---
3"	4	<b>T300</b>	<b>50.00</b>	<b>TR300</b>	<b>195.00</b>
4"	8	<b>T400</b>	<b>67.00</b>	<b>TR400</b>	<b>276.80</b>
5"	8	<b>T500</b>	<b>87.10</b>	---	---
6"	8	<b>T600</b>	<b>107.00</b>	<b>TR600</b>	<b>661.50</b>
8"	8	<b>T800</b>	<b>182.00</b>	---	---
10"	12	<b>T1000</b>	<b>520.00</b>	---	---
12"	12	<b>T1200</b>	<b>670.00</b>	---	---

• For flange dimensions, diagrams and additional information please reference [dixonvalve.com](http://dixonvalve.com).



150 Lb. Weld Neck ASA Forged Flanges

Feature:

- raised face

Size	Number of Bolts	Carbon Steel	
		Part #	Price/E
1"	4	<b>WN100</b>	<b>\$45.25</b>
1¼"	4	<b>WN125</b>	<b>47.00</b>
1½"	4	<b>WN150</b>	<b>47.25</b>
2"	4	<b>WN200</b>	<b>53.00</b>
3"	4	<b>WN300</b>	<b>62.75</b>
4"	8	<b>WN400</b>	<b>74.50</b>
5"	8	<b>WN500</b>	<b>115.00</b>
6"	8	<b>WN600</b>	<b>113.00</b>
8"	8	<b>WN800</b>	<b>198.00</b>
10"	12	<b>WN1000</b>	<b>310.00</b>

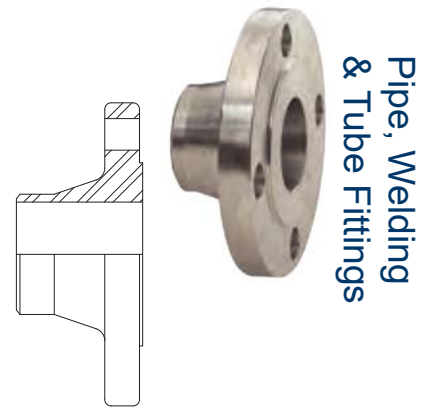

Pipe, Welding & Tube Fittings

Flange Gaskets

Features:

- standard drop-ring type all 1/16" thick
- reference page M-3 for joint sealant gasket material
- for dimensional information and diagrams please reference dixonvalve.com

Size	Carbon Steel		Klingersil® C-4401	
	Part #	Price/E	Part #	Price/E
1"	<b>NG10</b>	<b>\$1.60</b>	<b>AG10</b>	<b>\$2.80</b>
1¼"	<b>NG15</b>	<b>1.95</b>	<b>AG15</b>	<b>3.10</b>
1½"	<b>NG20</b>	<b>1.95</b>	<b>AG20</b>	<b>3.20</b>
2"	<b>NG25</b>	<b>2.10</b>	<b>AG25</b>	<b>3.35</b>
2½"	<b>NG30</b>	<b>2.80</b>	<b>AG30</b>	<b>4.10</b>
3"	<b>NG35</b>	<b>2.30</b>	<b>AG35</b>	<b>5.30</b>
4"	<b>NG40</b>	<b>3.20</b>	<b>AG40</b>	<b>6.40</b>
5"	<b>NG50</b>	<b>6.70</b>	---	---
6"	<b>NG60</b>	<b>4.15</b>	<b>AG60</b>	<b>9.85</b>
8"	<b>NG80</b>	<b>6.80</b>	<b>AG80</b>	<b>13.75</b>



carbon steel



Klingersil® C-4401

- For flange dimensions, diagrams and additional information please reference dixonvalve.com.

ANSI Flat Face Flange x Male NST (NH)

Features:

- flange - black powder coated carbon steel
- male adapter - black anodized aluminum

Size	PSI	Carbon Steel / Aluminum	
		Part #	Price/E
6" NST (NH)	<b>175</b>	<b>T600-60F</b>	<b>\$278.70</b>



King™ Turned Back Weld-To-Metal Hose Nipples

Features:

- MSS Length
- phono-finish face (type CS), except 10" and 12" have smooth face (type C)
- for use with Slip-On and Lap Joint flanges shown on page J-36

Size	Length	Schedule 40 Plated Carbon Steel		Schedule 40 304 Stainless Steel	
		Part #	Price/E	Part #	Price/E
1"	2"	<b>NW10</b>	<b>\$27.05</b>	<b>RNW10-40</b>	<b>\$50.00</b>
1¼"	2"	<b>NW15</b>	<b>41.15</b>	<b>RNW15-40</b>	<b>105.00</b>
1½"	2"	<b>NW20</b>	<b>37.70</b>	<b>RNW20-40</b>	<b>53.00</b>
2"	2½"	<b>NW25</b>	<b>40.65</b>	<b>RNW25-40</b>	<b>55.00</b>
2½"	2½"	<b>NW30</b>	<b>54.00</b>	<b>RNW30-40</b>	<b>110.00</b>
3"	2½"	<b>NW35</b>	<b>58.65</b>	<b>RNW35-40</b>	<b>75.00</b>
4"	3"	<b>NW40</b>	<b>76.30</b>	<b>RNW40-40</b>	<b>112.00</b>
6"	3½"	<b>NW60</b>	<b>114.60</b>	<b>RNW60-40</b>	<b>210.00</b>
8"	4"	<b>NW80</b>	<b>146.65</b>	<b>RNW80-40</b>	<b>375.00</b>
10"	5"	<b>NW100</b>	<b>295.00</b>	<b>RNW100-40</b>	<b>925.00</b>
12"	6"	<b>NW120</b>	<b>465.00</b>	<b>RNW120-40</b>	<b>1425.00</b>



Quick Release Couplings - Series Q

Features:

- designed for applications requiring a quick connection and/or disconnection of a pipe joint, a locking pin through the handle prevents accidental opening of the coupling
- ductile iron body with zinc plating and steel safety clip
- see page J-48 for replacement gaskets
- Comparable to: Victaulic's #78 Grinnell's #7003



Nominal Size	Pipe OD	Maximum Working Pressure PSI at 70°F (21°C)	Maximum End Load (Lbs.)	Ductile Iron		Price/E
				Part # with EPDM gasket	Part # with Buna-N gasket	
1½"	1.900"	300	850	<b>H315</b>	<b>H315BU</b>	\$135.00
2"	2.375"	300	1329	<b>H32</b>	<b>H32BU</b>	129.50
2½"	2.875"	300	2120	<b>H325</b>	<b>H325BU</b>	209.55
3"	3.500"	300	2886	<b>H33</b>	<b>H33BU</b>	166.50
4"	4.500"	300	4771	<b>H34</b>	<b>H34BU</b>	214.00
6"	6.625"	300	10341	<b>H36</b>	<b>H36BU</b>	460.00

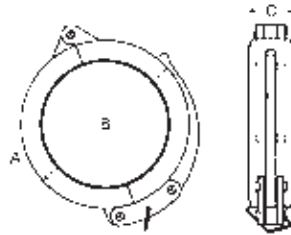

Dimensions

A	B	C
4¾"	3½"	1"
5½"	3¾"	1⅞"
5⅞"	4¾"	1⅞"
7¼"	5¼"	1⅞"
8½"	6½"	2"
10⅞"	8½"	2"

Standard Couplings - Series S, Style 11



Pipe, Welding & Tube Fittings

**Applications:**

- designed for a wide range of applications including commercial/industrial construction, mining, and process piping

**Features:**

- ductile iron body with rust inhibiting paint
- Underwriters Listed and Factory Mutual approved
- housing design allows for optimum strength without excessive casting weight.
- see pages J-48, J-49 for replacement gaskets, nuts and bolts
- Comparable to: Victaulic's #77  
Grinnell's #7001



Nominal Size	Pipe OD	Maximum Working Pressure PSI at 70°F (21°C)	Maximum End Load (Lbs.)	qty	Bolts		Ductile Iron		Price/E
					size	length	Part # w/EPDM gasket	Part # w/Buna-N gasket	
1½"	1.900"	1000	2835	2	¾"	2"	<b>C115</b>	<b>C115BU</b>	\$80.85
2"	2.375"	1000	4430	2	½"	2¾"	<b>C12</b>	<b>C12BU</b>	31.25
2½"	2.875"	1000	6492	2	½"	2¾"	<b>C125</b>	<b>C125BU</b>	33.30
3"	3.500"	1000	9621	2	½"	3"	<b>C13</b>	<b>C13BU</b>	40.55
4"	4.500"	1000	15904	2	⅝"	3¼"	<b>C14</b>	<b>C14BU</b>	67.40
6"	6.625"	1000	34472	2	¾"	4¼"	<b>C16</b>	<b>C16BU</b>	97.40
8"	8.625"	800	46741	2	⅞"	5"	<b>C18</b>	<b>C18BU</b>	232.40
10"	10.750"	800	72610	2	⅞"	5"	<b>C20</b>	<b>C20BU</b>	240.75
12"	12.750"	800	102141	2	⅞"	5"	<b>C24</b>	<b>C24BU</b>	350.50

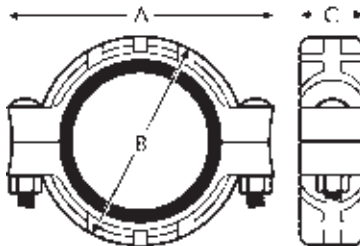

Dimensions

A	B	C
4-5/8"	3"	1-7/8"
5-15/64"	3-45/64"	1-27/32"
5-5/8"	4-1/4"	1-27/32"
6-21/32"	5"	1-27/32"
8-17/64"	6-3/8"	2-3/64"
11-7/32"	8-57/64"	2-3/64"
14-1/64"	11-3/8"	2-23/64"
16-5/8"	13-1/2"	2-5/8"
18-5/8"	15-1/2"	2-5/8"



Lightweight Flexible Couplings - Series L, Style 10

Pipe, Welding & Tube Fittings

Applications:

- designed for applications requiring moderate internal pressure or where weight is a factor such as general purpose, mining, irrigation, and compressed air where a deflection of 5% or less is required

Features:

- ductile iron body with rust inhibiting paint
- Underwriters Listed and Factory Mutual approved
- see pages J-48, J-49 for replacement gaskets, nuts and bolts
- Comparable to: Victaulic's #75 Grinnell's #7000



Nominal Size	Pipe OD	Maximum Working Pressure PSI at 70°F (21°C)	Maximum End Load (Lbs.)	qty	Bolts		Ductile Iron		Price/E
					size	lgth	Part # w/EPDM gasket	Part # w/Buna-N gasket	
1½"	1.900"	500	1418	2	⅜"	2¼"	L215	L215BU	\$64.50
2"	2.375"	500	2215	2	⅜"	2"	L02	L02BU	17.65
2½"	2.875"	300	3246	2	⅜"	2"	L025	L025BU	20.20
3"	3.500"	300	4811	2	½"	2¾"	L03	L03BU	23.75
4"	4.500"	300	6362	2	½"	2¾"	L04	L04BU	31.20
5"	5.563"	300	9722	2	⅝"	3¼"	L05	L05BU	63.65
6"	6.625"	300	13789	2	⅝"	3¼"	L06	L06BU	52.05
8"	8.625"	300	20449	2	¾"	4¼"	L08	L08BU	88.50
10"	10.750"	350	29815	2	¾"	4¼"	L010	L010BU	132.00
12"	12.750"	350	40581	2	⅞"	5"	L012	L012BU	184.00

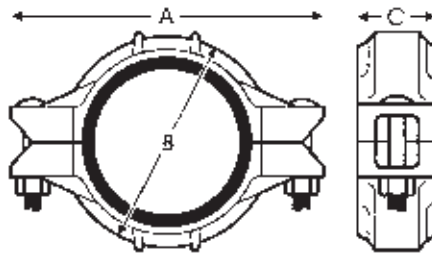

Dimensions

A	B	C
4-5/8"	3"	1-3/4"
5-7/64"	3-1/2"	1-27/32"
5-55/64"	4-1/64"	1-27/32"
6-13/32"	4-13/16"	1-27/32"
7-33/64"	5-55/64"	2"
9-5/8"	7"	2"
10-25/32"	7-7/8"	2-3/64"
13-47/64"	10-35/64"	2-13/32"
16-19/64"	13-15/64"	2-9/16"
18-23/64"	15-7/16"	2-9/16"



Lite® Couplings - Stainless Steel



**Applications:**

- designed for use on rigid, locked-in pipe connections

**Features:**

- 316 cast stainless steel body, nuts and bolts
- certified to ANSI/NSF 61
- ideal for corrosive environments
- use of suitable anti-galling thread compound is recommended
- Comparable to: Grinnell's #7400 SS



Nominal Size	Pipe OD	Maximum Working Pressure (PSI)	Maximum End Load (Lbs.)	Bolts			316 Stainless Steel	
				qty	size	length	Part # w/ Fluoro-elastomer gasket	Price/E
2"	2.375"	300	1329	2	3/8"	2 1/4"	<b>RL02V</b>	<b>\$1140.00</b>
3"	3.500"	300	2886	2	1/2"	2 3/4"	<b>RL03V</b>	<b>1430.00</b>
4"	4.500"	300	4771	2	1/2"	2 3/4"	<b>RL04V</b>	<b>2120.00</b>

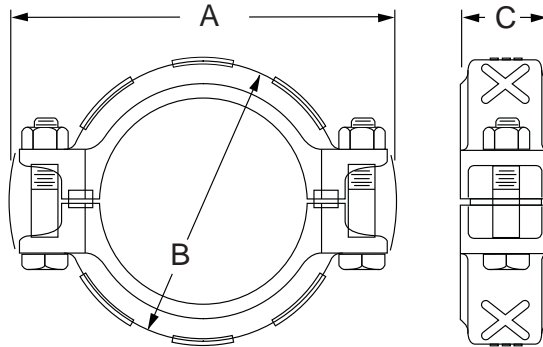

Dimensions

A	B	C
5 3/8"	3 5/8"	1 3/4"
6 5/8"	4 5/8"	1 3/4"
7 3/4"	6"	1 7/8"



Rigid Couplings - Series R, Style 5

Pipe, Welding & Tube Fittings

Application:

- ideal for fire protection, plumbing, low pressure air and drainage

Features:

- lightweight, low pressure
- galvanized ductile iron body
- small gripping teeth hold the housing into the groove allowing a straight run of pipe and preventing any flex at the joint
- Underwriters Listed and Factory Mutual approved
- see pages J-48, J-49 for replacement gaskets, nuts and bolts



Nominal Size	Pipe OD	Maximum Working Pressure PSI at 70°F (21°C)	Maximum End Load (Lbs.)	qty	Bolts		Ductile Iron		Price/E
					size	length	Part # w/EPDM gasket	Part # w/Buna-N gasket	
2"	2.375"	175	4425	2	3/8"	2"	R72	R72BU	\$21.25
2½"	2.875"	175	6490	2	3/8"	2"	R725	R725BU	18.30
3"	3.500"	175	9620	2	½"	2¾"	R73	R73BU	25.75
4"	4.500"	175	12720	2	½"	2¾"	R74	R74BU	32.45
6"	6.625"	175	27570	2	5/8"	3¼"	R76	R76BU	54.95
8"	8.625"	175	35050	2	¾"	4¼"	R78	R78BU	88.50

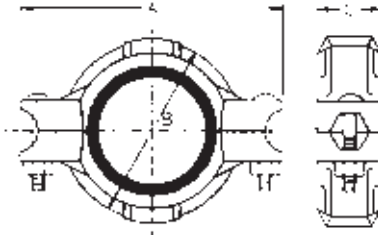

Dimensions

A	B	C
4-7/8"	3-17/32"	1-27/32"
5-5/8"	3-45/64"	1-3/4"
6-3/8"	4-41/64"	1-27/32"
7-45/64"	5-15/16"	2"
10-25/32"	8-7/64"	2-3/64"
13-25/32"	10"	2-21/64"





Grooved Bolted Clamps

Features:

- 2" pressure rating: **400 PSI**
- 3" pressure rating: **170 PSI**
- 4" pressure rating: **120 PSI**
- bolt torque: 20 ft. lbs.
- precision casting and machined dimensions provide an exact fit and great appearance
- use of lock nuts prevents clamps from loosening in high vibration applications
- leak-tight connection
- are intended for tank truck applications only 
- Unlike steel groove clamps that secure pipe ends with high clamp force against the tubing walls, the Dixon® bolted clamp takes the full bolt force and locks in the groove of the tube preventing distortion of the tube diameter.
- FKM-B rated for 100% biodiesel and Ethanol
- Buna-N rated for petroleum service, Ethanol to E100 and biodiesel to B20
- Baylast™ rated for petroleum service, Ethanol to E100 and biodiesel to B100
- white buna-N for use in dry bulk food applications
- temperature ratings for FKM-B is **20°F to 300°F (-7°C to 149°C)**
- temperature ratings for Baylast is **-20°F to 180°F (-29°C to 82°C)**



clamp with black buna gasket  
Note: Supplied clamp gasket must be installed prior to use, ships separately.

Size	Gasket Material	Aluminum	
		Part #	Price/E
2"	FKM-B	DBV-VB200	\$79.85
3"	FKM-B	DBV-VB300	90.20
4"	FKM-B	DBV-VB400	148.55
3"	buna-N	DBV-BN300	37.15
4"	buna-N	DBV-BN400	47.75
2"	Baylast™	DBV-BL200	51.50
3"	Baylast™	DBV-BL300	61.15
4"	Baylast™	DBV-BL400	77.25
4"	white buna-N	DBV-WB400	58.35

Replacement Gaskets

Size	Material	Part #	Price/E
2"	FKM-B	G200VB	\$61.05
3"	FKM-B	G300VB	58.35
4"	FKM-B	G400VB	116.70
3"	buna-N	G300T	12.30
4"	buna-N	G400T	17.90
2"	Baylast™	G200BL	29.00
3"	Baylast™	G300BL	34.95
4"	Baylast™	G400BL	41.45
4"	white buna-N	G400N	36.50



Painted Iron Clamps with Baylast™ Gaskets

Features:

- painted red
- Baylast™ seal is rated for biodiesel, Ethanol, diesel, gas and ULSD

Size	Maximum PSI	Iron	
		Part #	Price/E
2"	500	L02BL	\$85.95
3"	300	L03BL	102.00
4"	300	L04BL	128.85



Mechanical Tees - Series T



Features:

- Provides a fast easy way to install a threaded connection along a length of pipe. After drilling or cutting a hole in the pipe at the location of the branch connection, simply attach the clamps around the pipe for a leak-free threaded outlet connection. See chart below for drilling hole specifications
- ductile iron body with rust inhibiting paint
- Underwriters Listed and Factory Mutual approved
- maximum operating pressure: **300 PSI at 70°F (21°C)**
- see pages J-48, J-49 for replacement gaskets, nuts and bolts

- Comparable to:  
Victaulic's #920  
Grinnell's #7045

Pipe, Welding & Tube Fittings



Nominal Size	Branch Size	Hole Saw Diameter	Maximum End Load (Lbs.)	qty	Bolts		Ductile Iron	
					size	length	Part #	Price/E
2"	1"	1 1/2"	1 5/8"	2	3/8"	2"	<b>MT2010</b>	<b>\$37.45</b>
2"	1 1/4"	1 3/4"	1 7/8"	2	3/8"	2"	<b>MT20125</b>	<b>41.20</b>
2"	1 1/2"	1 3/4"	1 7/8"	2	3/8"	2"	<b>MT20150</b>	<b>41.20</b>
2 1/2"	1"	1 1/2"	1 5/8"	2	1/2"	2 5/8"	<b>MT25010</b>	<b>47.45</b>
2 1/2"	1 1/4"	2"	2 1/8"	2	1/2"	2 5/8"	<b>MT250125</b>	<b>51.20</b>
3"	1"	1 1/2"	1 5/8"	2	1/2"	2 3/4"	<b>MT3010</b>	<b>56.20</b>
3"	1 1/2"	2"	2 1/8"	2	1/2"	2 3/4"	<b>MT30150</b>	<b>51.20</b>
4"	1"	1 1/2"	1 5/8"	2	1/2"	2 3/4"	<b>MT4010</b>	<b>71.45</b>
4"	1 1/4"	2"	2 1/8"	2	1/2"	2 3/4"	<b>MT40125</b>	<b>58.65</b>
4"	1 1/2"	2"	2 1/8"	2	1/2"	2 3/4"	<b>MT40150</b>	<b>61.15</b>
4"	2"	2 1/2"	2 5/8"	2	1/2"	2 3/4"	<b>MT4020</b>	<b>61.15</b>
4"	2 1/2"	2 3/4"	2 7/8"	2	1/2"	2 3/4"	<b>MT40250</b>	<b>63.65</b>
4"	3"	3 1/2"	3 5/8"	2	1/2"	2 3/4"	<b>MT4030</b>	<b>68.05</b>
6"	1 1/4"	2 1/2"	2 5/8"	2	5/8"	3 1/4"	<b>MT60125</b>	<b>76.75</b>
6"	1 1/2"	2 1/2"	2 5/8"	2	5/8"	3 1/4"	<b>MT60150</b>	<b>76.75</b>
6"	2"	2 1/2"	2 5/8"	2	5/8"	3 1/4"	<b>MT6020</b>	<b>76.75</b>
6"	3"	3 1/2"	3 5/8"	2	5/8"	3 1/4"	<b>MT6030</b>	<b>88.65</b>

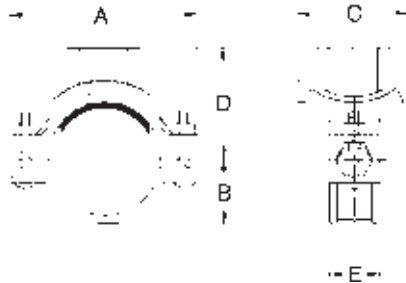

Dimensions

A	B	C	D	E
4 1/2"	1 3/8"	2 3/4"	2 1/4"	1 7/8"
4 1/2"	1 3/8"	2 3/4"	2 1/2"	1 7/8"
4 1/2"	1 3/8"	2 3/4"	2 1/2"	1 7/8"
5-5/32"	1-11/16"	3"	2-31/32"	2"
5-13/16"	1-11/16"	3-11/32"	3"	2"
6-11/32"	2-1/8"	3-3/32"	3-1/16"	2"
6-11/32"	2-1/8"	3-3/4"	3-3/8"	2"
7-5/16"	2-9/16"	3-3/32"	3-1/2"	2"
7-5/16"	2-9/16"	3-3/4"	3-7/8"	2"
7-5/16"	2-9/16"	3-3/4"	3-7/8"	2"
7-5/16"	2-9/16"	4-1/8"	4"	2"
7-5/16"	2-9/16"	4-3/8"	4"	2"
7-5/16"	2-9/16"	5-1/4"	4-1/4"	2"
10-5/32"	3-11/16"	4-1/8"	4-7/8"	2 1/4"
10-5/32"	3-11/16"	4-1/8"	4-7/8"	2 1/4"
10-5/32"	3-11/16"	4-1/8"	5"	2 1/4"
10-5/32"	3-11/16"	5-1/4"	5-3/8"	2 1/4"



## Flange Adapters - Series FA

**Application:**

- used to connect an ANSI Class 125 and 150 flange to a grooved pipe using a grooved clamp

**Features:**

- Provides a rigid one piece connection that can be disconnected by removing the clamp assembly. To assemble to another flange, position bolt heads on the adapter (grooved) side.
- ductile iron body with rust inhibiting paint

Nominal Size	Pipe OD	Maximum Working Pressure PSI at 70°F (21°C)	Flange Dimensions		Bolts		Ductile Iron	
			A	B	qty	size	Part #	Price/E
2"	2.375"	300	6"	2-3/8"	4	5/8"	<b>FA20</b>	<b>\$37.40</b>
3"	3.500"	300	7 1/4"	2-3/8"	4	5/8"	<b>FA30</b>	<b>61.15</b>
4"	4.500"	300	8 1/2"	2-3/8"	8	5/8"	<b>FA40</b>	<b>77.40</b>
6"	6.625"	300	11"	2-9/16"	8	3/4"	<b>FA60</b>	<b>142.30</b>
8"	8.625"	300	13 1/4"	3"	8	3/4"	<b>FA80</b>	<b>208.50</b>

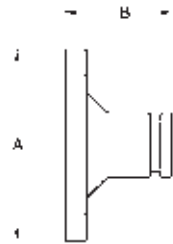

Pipe, Welding & Tube Fittings

## ANSI Split Flanges - Series SF



**Features:**

- provides a direct connection between a grooved adapter and an ANSI Class 125 and 150 raised face flanged component
- can be used with flat face flanges by removing the raised projections on the outside face of the flange.
- ductile iron body with rust inhibiting paint
- Underwriters Listed and Factory Mutual approved
- Buna gaskets are available upon request
- Comparable to: Victaulic's #741 Grinnell's #7012

Nom. Size	Pipe OD	Max. Work. Press. PSI at 70°F (21°C)	Flange Dims.		Bolts		Ductile Iron w/ Gasket		Replacement EPDM Gaskets	
			A	B	qty	size	Part # <sup>1</sup>	Price/E	Part # <sup>2</sup>	Price/E
2"	2.375"	300	6"	13/16"	4	5/8"	<b>ANSI20</b>	<b>\$75.85</b>	<b>FLG200E</b>	<b>\$8.15</b>
2 1/2"	2.875"	300	7"	13/16"	4	5/8"	<b>ANSI25</b>	<b>82.05</b>	<b>FLG250E</b>	<b>9.40</b>
3"	3.500"	300	7 1/2"	13/16"	4	5/8"	<b>ANSI30</b>	<b>98.60</b>	<b>FLG300E</b>	<b>10.95</b>
4"	4.500"	300	9"	15/16"	8	5/8"	<b>ANSI40</b>	<b>131.05</b>	<b>FLG400E</b>	<b>12.50</b>
6"	6.625"	300	11"	1"	8	3/4"	<b>ANSI60</b>	<b>156.00</b>	<b>FLG600E</b>	<b>19.35</b>
8"	8.625"	300	13 1/2"	1-1/8"	8	3/4"	<b>ANSI80</b>	<b>199.70</b>	<b>FLG800E</b>	<b>34.00</b>

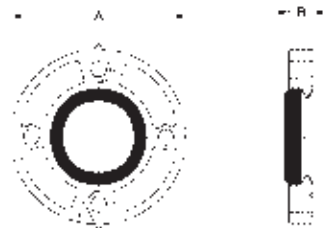

<sup>1</sup> with EPDM gasket  
<sup>2</sup> replacement gasket

## Reducing Adapters - Series RA



**Features:**

- ductile iron body with rust inhibiting paint
- Underwriters Listed and Factory Mutual approved
- Comparable to: Victaulic's #50, Grinnell's #7072

Nominal Size	Nominal Size	Dimensions E to E	Ductile Iron	
			Part #	Price/E
2"	1 1/2"	2.5"	<b>RAGG20150</b>	<b>\$26.25</b>
2 1/2"	2"	2.5"	<b>RAGG25020</b>	<b>27.45</b>
3"	2"	2.5"	<b>RAGG3020</b>	<b>26.25</b>
3"	2 1/2"	2.5"	<b>RAGG30250</b>	<b>32.45</b>
4"	2"	3.0"	<b>RAGG4020</b>	<b>38.60</b>
4"	2 1/2"	3.0"	<b>RAGG40250</b>	<b>40.55</b>
4"	3"	3.0"	<b>RAGG4030</b>	<b>43.25</b>
5"	4"	3.5"	<b>RAGG5040</b>	<b>69.90</b>
6"	2"	4.0"	<b>RAGG6020</b>	<b>82.00</b>
6"	2 1/2"	4.0"	<b>RAGG60250</b>	<b>90.30</b>
6"	3"	4.0"	<b>RAGG6030</b>	<b>82.40</b>
6"	4"	4.0"	<b>RAGG6040</b>	<b>82.40</b>

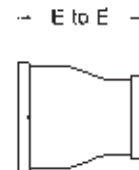



Grooved End Fittings - Series 45

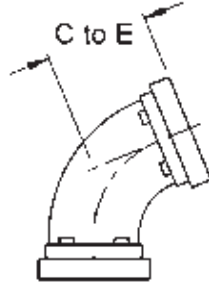

Features:

- designed to provide minimum pressure drop and uniform strength
- maximum operating pressure: **500 PSI** at ambient temperature **70°F (21°C)**
- ductile iron body with rust inhibiting paint
- Underwriters Listed and Factory Mutual approved
- Comparable to:  
Victaulic's #110  
Grinnell's #7051

Nominal Size	Dimensions C to E	Ductile Iron	
		Part #	Price/E
2"	2"	<b>L2045</b>	<b>\$22.15</b>
2½"	2¼"	<b>L2545</b>	<b>23.05</b>
3"	2½"	<b>L3045</b>	<b>34.95</b>
4"	3"	<b>L4045</b>	<b>51.15</b>
5"	3¼"	<b>L5145</b>	<b>113.50</b>
6"	3½"	<b>L6045</b>	<b>129.50</b>
8"	4¼"	<b>L8045</b>	<b>258.90</b>



Grooved End Fittings - Series 90

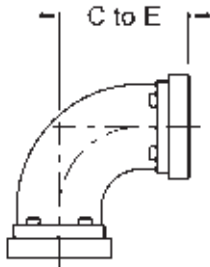

Features:

- designed to provide minimum pressure drop and uniform strength
- maximum operating pressure: **500 PSI** at ambient temperature **70°F (21°C)**
- ductile iron body with rust inhibiting paint
- Underwriters Listed and Factory Mutual approved
- Comparable to:  
Victaulic's #10  
Grinnell's #7050

Nominal Size	Dimensions C to E	Ductile Iron	
		Part #	Price/E
2"	3¼"	<b>L502</b>	<b>\$22.50</b>
2½"	3¾"	<b>L5025</b>	<b>25.85</b>
3"	4¼"	<b>L503</b>	<b>41.20</b>
4"	5"	<b>L504</b>	<b>54.15</b>
6"	6½"	<b>L506</b>	<b>129.50</b>
8"	7¾"	<b>L508</b>	<b>287.05</b>



Grooved End Fittings - Series T

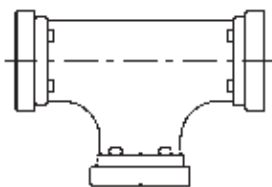

Features:

- designed to provide minimum pressure drop and uniform strength
- maximum operating pressure: **500 PSI** at ambient temperature **70°F (21°C)**
- ductile iron body with rust inhibiting paint
- Underwriters Listed and Factory Mutual approved
- Comparable to:  
Victaulic's #20  
Grinnell's #7060

Nominal Size	Dimensions C to E	Ductile Iron	
		Part #	Price/E
2"	3¼"	<b>T602</b>	<b>\$32.45</b>
2½"	3¾"	<b>T6025</b>	<b>39.95</b>
3"	4¼"	<b>T603</b>	<b>54.95</b>
4"	5"	<b>T604</b>	<b>81.30</b>
6"	6½"	<b>T606</b>	<b>196.75</b>
8"	7¾"	<b>T608</b>	<b>425.25</b>

ANSI Caps with Tapped Outlet - Series EC

Feature:

- ductile iron construction with rust inhibiting paint

Nominal Size	Outlet	Dimensions E to E	Ductile Iron	
			Part #	Price/E
2"	1"	7/8"	<b>EC201</b>	<b>\$31.30</b>
2½"	1"	7/8"	<b>EC251</b>	<b>40.50</b>
3"	1"	7/8"	<b>EC301</b>	<b>40.30</b>
4"	1"	1"	<b>EC401</b>	<b>43.85</b>
4"	2"	1"	<b>EC402</b>	<b>39.85</b>
6"	1"	1"	<b>EC601</b>	<b>99.05</b>
6"	2"	1"	<b>EC602</b>	<b>105.20</b>
8"	2"	1-3/16"	<b>EC802</b>	<b>202.15</b>



Pipe, Welding  
& Tube Fittings

Blank Caps - Series BE

Features:

- ductile iron body with rust inhibiting paint
- Underwriters Listed and Factory Mutual approved

- Comparable to:  
Victaulic's #60  
Grinnell's #7074



Nominal Size	Dimensions E to E	Ductile Iron	
		Part #	Price/E
2"	7/8"	<b>BEC20</b>	<b>\$27.45</b>
2½"	7/8"	<b>BEC25</b>	<b>36.20</b>
3"	7/8"	<b>BEC30</b>	<b>37.45</b>
4"	1"	<b>BEC40</b>	<b>38.70</b>
6"	1"	<b>BEC60</b>	<b>96.75</b>
8"	1-3/16"	<b>BEC80</b>	<b>178.50</b>



Long Pipe Style Nipples - Series AN

Groove x NPT	Dimensions E to E	Carbon Steel	
		Part #	Price/E
2"	4"	<b>A712</b>	<b>\$48.65</b>
2½"	4"	<b>A7125</b>	<b>57.05</b>
3"	4"	<b>A713</b>	<b>88.60</b>
4"	6"	<b>A714</b>	<b>115.80</b>
5"	6"	<b>A715</b>	<b>185.00</b>
6"	6"	<b>A716</b>	<b>205.00</b>

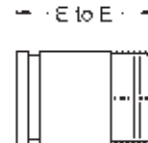

Grooved End x Weld Nipples

Nominal Size	Aluminum		Carbon Steel		316 Stainless Steel	
	Part #	Price/E	Part #	Price/E	Part #	Price/E
2"	<b>AVN2000-200</b>	<b>\$18.50</b>	<b>VN2000-200</b>	<b>\$19.15</b>	<b>VNR2000-200</b>	<b>\$29.15</b>
2½"	<b>AVN2500-200</b>	<b>33.40</b>	<b>VN2500-200</b>	<b>21.70</b>	<b>VNR2500-200</b>	<b>30.40</b>
3"	<b>AVN3000-200</b>	<b>26.30</b>	<b>VN3000-200</b>	<b>24.25</b>	<b>VNR3000-200</b>	<b>38.75</b>
4"	<b>AVN4000-200</b>	<b>42.30</b>	<b>VN4000-200</b>	<b>37.10</b>	<b>VNR4000-200</b>	<b>53.70</b>



- For additional information on pipe dimensions please reference dixonvalve.com.

Grooved End **Butterfly** Valves

Features:

- for water and air applications
- working pressure: **300 PSI**
- maximum temperature: **210°F (99°C)**
- material: **body:** ductile iron, epoxy coated; **disc:** ductile iron, EPDM encapsulated; **stem:** stainless steel; **notch plate:** zinc plated steel; **seals:** EPDM

Size	Ductile Iron	
	Part #	Price/E
2"	<b>GIBFV200</b>	<b>\$232.00</b>
2½"	<b>GIBFV250</b>	<b>266.00</b>
3"	<b>GIBFV300</b>	<b>367.00</b>
4"	<b>GIBFV400</b>	<b>476.00</b>
6"	<b>GIBFV600</b>	<b>810.00</b>
8"	<b>GIBFV800</b>	<b>1010.00</b>





GROOVED COUPLING



GASKET PIPE or FITTING

## Grooved Fitting Gaskets

Pipe, Welding & Tube Fittings

- check gasket color code to be certain it is recommended for the service intended
- use lubricant on gasket (reference next page)
- for services not listed contact Dixon® for recommendations

### FKM Gaskets

**Features:**

- temperature range: **-13°F to 350°F (-11°C to 177°C)**
- color code: black with blue stripe
- resistant to oxidizing acids, petroleum oils, hydraulic fluids, halogenated hydrocarbons and lubricants



Size	FKM	
	Part #	Price/E
2"	<b>G200V</b>	<b>\$38.35</b>
3"	<b>G300V</b>	<b>57.05</b>
4"	<b>G400V</b>	<b>79.45</b>
6"	<b>G600V</b>	<b>113.00</b>
8"	<b>G800V</b>	<b>188.50</b>
10"	<b>G1000V</b>	<b>233.95</b>
12"	<b>G1200V</b>	<b>295.55</b>

### EPDM Gaskets

**Features:**

- temperature range: **-22°F to 230°F (-30°C to 110°C)**
- color code: black with green stripe
- for water, dilute acids, alkalis, salts, and many chemical services not involving hydrocarbons, oils, or gases.
- excellent oxidation resistance
- *Not for use with hydrocarbons* 



Size	EPDM	
	Part #	Price/E
1½"	<b>G150E</b>	<b>\$34.60</b>
2"	<b>G200E</b>	<b>9.25</b>
2½"	<b>G250E</b>	<b>11.10</b>
3"	<b>G300E</b>	<b>12.30</b>
4"	<b>G400E</b>	<b>17.90</b>
5"	<b>G500E</b>	<b>25.10</b>
6"	<b>G600E</b>	<b>32.30</b>
8"	<b>G800E</b>	<b>52.60</b>
10"	<b>G1000E</b>	<b>67.00</b>
12"	<b>G1200E</b>	<b>92.00</b>

### Buna Gaskets

**Features:**

- temperature range: **-24°F to 176°F (-31°C to 80°F)**
- for petroleum products, vegetable oils, mineral oils, and air contaminated with petroleum oils.
- *not for use in hot water services* 



Size	Black Buna with orange stripe		White Buna	
	Part #	Price/E	Part #	Price/E
1½"	<b>G150T</b>	<b>\$34.60</b>	---	---
2"	<b>G200T</b>	<b>9.25</b>	---	---
2½"	<b>G250T</b>	<b>11.10</b>	---	---
3"	<b>G300T</b>	<b>12.30</b>	---	---
4"	<b>G400T</b>	<b>17.90</b>	<b>G400N</b>	<b>\$36.50</b>
5"	<b>G500T</b>	<b>25.10</b>	---	---
6"	<b>G600T</b>	<b>32.30</b>	---	---
8"	<b>G800T</b>	<b>52.60</b>	---	---
10"	<b>G1000T</b>	<b>67.00</b>	---	---
12"	<b>G1200T</b>	<b>92.00</b>	---	---



## Grooved Fitting Accessories

## Nuts and Bolts

## Features:

- the nuts are a heavy hexagon design
- specifically designed for use with the couplings on pages J-39 to J-44

## Specification:

- conforms to ASTM A183

Bolt Thread	Bolt Length	Torque Ft. Lbs.	Electroplated Carbon Steel	
			Part #	Price/E
3/8"	2"	30	<b>BLT38200</b>	<b>\$5.95</b>
3/8"	2¼"	30	<b>BLT38225</b>	<b>19.30</b>
1/2"	2½"	50	<b>BLT50212</b>	<b>5.95</b>
1/2"	2¾"	50	<b>BLT50234</b>	<b>8.15</b>
1/2"	3"	50	<b>BLT50300</b>	<b>9.80</b>
5/8"	3¼"	75	<b>BLT58314</b>	<b>5.35</b>
3/4"	4¼"	75	<b>BLT75414</b>	<b>17.50</b>
7/8"	5"	200	<b>BLT78500</b>	<b>18.50</b>



## Groove Lube

## Features:

- water soluble
- non-toxic
- non-corrosive
- non-flammable
- *should not be used with HDPE pipe*



## Specification:

- NSF approved for use with potable water

Size	Container	Part #	Price/E
1 qt.	Tub	<b>GROOVLUB32</b>	<b>\$263.00</b>



## High Density Polyethylene (HDPE) Couplings

**Applications:**

- designed for mechanically joining high density polyethylene pipe and fittings

**Features:**

- ductile iron body with rust inhibiting paint
- uses four bolts to drive the sharply machined housing teeth into the outside of the pipe
- Comparable to: Grinnell's #9095

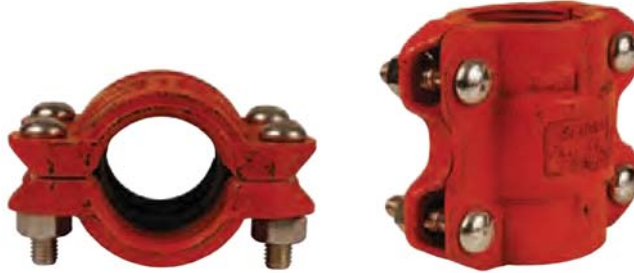

Nominal Size	Pipe OD	qty	Bolts		Part # w/EPDM gasket	Ductile Iron		Price/E
			size	length		Part # w/Buna-N gasket		
2"	2.375"	4	1/2"	2 3/8"	<b>HDPE200</b>	<b>HDPE200BU</b>		<b>\$510.00</b>
3"	3.500"	4	1/2"	3"	<b>HDPE300</b>	<b>HDPE300BU</b>		<b>610.00</b>
4"	4.500"	4	1/2"	3"	<b>HDPE400</b>	<b>HDPE400BU</b>		<b>670.00</b>
6"	6.625"	4	5/8"	3 1/2"	<b>HDPE600</b>	<b>HDPE600BU</b>		<b>930.00</b>

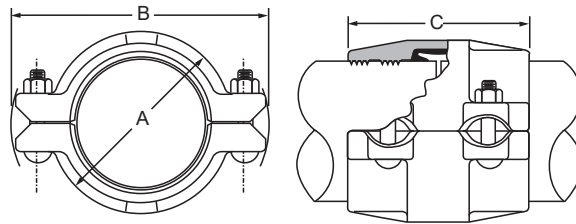

**Dimensions**

A	B	C
3 3/8"	5 1/2"	4 5/8"
4 5/8"	6 3/4"	4 5/8"
5 1/4"	8"	5 3/4"
7 1/2"	11"	5 7/8"



Y Line Strainers

Cast Iron

Features:

- graphite gasket
- working pressure: **400 PSI WOG, 250 PSI steam**
- plug ported for blowdown service
- no replacement screens available

Female NPT	Description	Cast Iron	
		Part #	Price/E
1/4"	20 x 20 mesh	Y001	\$30.00
3/8"		Y002	30.00
1/2"		Y003	36.00
3/4"		Y004	44.00
1"		Y005	55.00
1 1/4"		Y006	78.00
1 1/2"		Y007	96.00
2"		Y008	144.00



Pipe, Welding & Tube Fittings

Cast Bronze

Feature:

- working pressure: **400 PSI WOG, 125 PSI steam**

Female NPT	Description	Cast Bronze		304 Stainless Replacement Screens	
		Part #	Price/E	Part #	Price/E
1/4"	50 x 50 mesh	59-001	\$52.00	G3271-00	\$6.50
3/8"	50 x 50 mesh	59-002	52.00	G2457-00	6.85
1/2"	50 x 50 mesh	59-003	52.00	G2457-00	6.85
3/4"	20 x 20 mesh	59-004	99.00	G3224-00	6.25
1"	20 x 20 mesh	59-005	131.00	G3225-00	13.70
1 1/4"	20 x 20 mesh	59-006	235.00	G3231-00	19.25
1 1/2"	20 x 20 mesh	59-007	261.00	G3229-00	20.75
2"	20 x 20 mesh	59-008	427.00	G3230-00	16.00



replacement screen

Polypropylene

Features:

- protects and prevents clogging of pipelines, pumps and spray tips
- glass-filled polypropylene body
- easy access for cleaning
- maximum operating pressure: **90 PSI at 70°F (21°C)**

Female NPT	Description	Polypropylene		304 Stainless Replacement Screens	
		Part #	Price/E	Part #	Price/E
3/4"	40 mesh	PYLS7540	\$35.50	61450	\$17.10
1"	40 mesh	PYLS10040	44.25	61746	18.50
1 1/2"	40/20 mesh	PYLS15040	97.00	61509	43.00
2"	40/20 mesh	PYLS20040	97.00	61509	43.00



replacement screen

Polypropylene T Line Strainers

Features:

- white polypropylene allows easy inspection
- maximum operating pressure: **100 PSI at 70°F (21°C)**

Female NPT	Description	Polypropylene		304 Stainless Replacement Screens	
		Part #	Price/E	Part #	Price/E
3/4"	40 mesh	PTLS7540	\$26.25	61405	\$12.00
1"	40 mesh	PTLS10040	26.25	61405	12.00



LP Gas Couplings and Adapters

Specifications:

- products meet or exceed the requirements of Compressed Gas Association (CGA), the National Fire Protection Association (NFPA), the Canadian Gas Association, American Society of Mechanical Engineers (ASME) and Underwriters Laboratories (UL)

Male Acme x Male NPT Adapters



ME217

ME233



ME502-12/8

ME503-16

Male Acme	Male NPT	Female NPT	Part #	Brass	Price/E
1 3/4"	1 1/4"	--	<b>ME217</b>		<b>\$38.60</b>
2 1/4"	1 1/4"	--	<b>ME233</b>		<b>148.05</b>
2 1/4"	1 1/2"	1"	<b>ME502-12/8</b> <sup>1</sup>		<b>228.90</b>
3 1/4"	2"	--	<b>ME503-16</b>		<b>184.80</b>

<sup>1</sup> dual threads - male outside / female inside

Male Acme x Female NPT Adapters



Male Acme	Female NPT	Part #	Brass	Price/E
1 3/4"	1"	<b>ME214</b>		<b>\$38.60</b>
3 1/4"	2"	<b>ME252-16</b>		<b>169.05</b>

Male Acme x Male NPT Adapters



ME217S

ME503S-16

Male Acme	Male NPT	Part #	Steel	Price/E
1 3/4"	1 1/4"	<b>ME217S</b>		<b>\$92.95</b>
2 1/4"	1 1/4"	<b>ME233S</b>		<b>181.65</b>
3 1/4"	2"	<b>ME503S-16</b>		<b>385.35</b>

Male Acme x Female NPT Adapter



Male Acme	Female NPT	Part #	Steel	Price/E
3 1/4"	2"	<b>ME252S-16</b>		<b>\$263.55</b>

Female Acme x Male Acme Adapters



brass

steel

Female Acme	Male Acme	Material	Part #	Price/E
3 1/4"	1 3/4"	brass	<b>ME612</b>	<b>\$281.40</b>
3 1/4"	1 3/4"	steel	<b>ME612S</b>	<b>414.75</b>

LP Gas Couplings and Adapters

Female Acme x MNPT Filler Couplings, Brass Nut

Female Acme	Male NPT	Material	Part #	Price/E
1 3/4"	1"	brass nut, brass nipple	<b>ME112</b>	<b>\$48.85</b>
2 1/4"	1 1/4"	brass nut, brass nipple	<b>ME120</b>	<b>222.60</b>
2 1/4"	1 1/4"	brass nut, steel nipple	<b>ME120S</b>	<b>262.50</b>
3 1/4"	2"	brass nut, steel nipple	<b>ME130</b>	<b>324.45</b>



Pipe, Welding & Tube Fittings

Female Acme x MNPT Filler Couplings, Steel Nut

Female Acme	Male NPT	Steel	
		Part #	Price/E
1 3/4"	1"	<b>ME112S</b>	<b>\$107.65</b>
2 1/4"	1 1/4"	<b>ME121S</b>	<b>232.05</b>
3 1/4"	2"	<b>ME130S</b>	<b>266.70</b>



Acme Gaskets

Size	Nitrile	
	Part #	Price/E
1 3/4"	<b>MEW2</b>	<b>\$0.75</b>
2 1/4"	<b>MEW5</b>	<b>3.70</b>
3 1/4"	<b>MEW6</b>	<b>3.85</b>



Clamp Style Hose Couplings

Features:

- clamp sections and hose bars are made of steel and ductile iron
- 32B and 32S sizes offer a female Acme swivel to eliminate the need to add additional weight and bulk to the hose assembly

Hose Barb	Thread Size	Material	Part #	Price/E
1"	1" male NPT	steel nipple, 2-piece ductile iron clamp	<b>ME3162-16</b>	<b>\$100.80</b>
1 1/4"	1 1/4" male NPT	steel nipple, 2-piece ductile iron clamp	<b>ME3162-20</b>	<b>161.70</b>
1 1/2"	1 1/2" male NPT	steel nipple, 2-piece ductile iron clamp	<b>ME3162-24</b>	<b>211.05</b>
2"	2" male NPT	steel nipple, 2-piece ductile iron clamp	<b>ME3162-32</b>	<b>241.50</b>
2"	3 1/4" female Acme	steel nipple, brass nut, 2-piece ductile iron clamp	<b>ME3162-32B</b>	<b>478.80</b>
2"	3 1/4" female Acme	steel nipple, steel nut, 2-piece ductile iron clamp	<b>ME3162-32S</b>	<b>473.55</b>



Acme Spanner Wrench

Feature:

- used on 1 3/4", 2 1/4", 3 1/4" and 4 1/4" fittings

Aluminum	
Part #	Price/E
<b>MEP120B</b>	<b>\$117.60</b>



LP Gas Hose Caps and Plugs

Metal Caps



ME229



ME441F

Female Acme Threads	Description	Material	Part #	Price/E
1 3/4"	cap with ring and chain	brass	<b>ME229-1</b>	<b>\$75.10</b>
1 3/4"	cap with ring and chain	steel	<b>ME229S-1</b>	<b>128.10</b>
2 1/4"	cap with knob plug and chain	brass	<b>ME431F-1</b>	<b>189.00</b>
2 1/4"	cap with knob plug, ring, chain	steel	<b>ME431FS-1</b>	<b>214.20</b>
3 1/4"	cap with knob plug, ring and chain	brass	<b>ME441F-1</b>	<b>286.65</b>
3 1/4"	cap with knob plug, ring and chain	steel	<b>ME441FS-1</b>	<b>312.90</b>

Plastic Caps



ME109-1



ME109-NH3-1

Female Acme Threads	Description	Plastic	
		Part #	Price/E
1 3/4"	cap with ring and chain, yellow	<b>ME109-1</b>	<b>\$9.00</b>
1 3/4"	cap with chain assembly, for anhydrous service	<b>ME109-NH3-1</b>	<b>10.20</b>

Plastic Dust Plugs



ME179-1



ME180-1



ME181-1

Male Acme Threads	Description	Plastic	
		Part #	Price/E
1 3/4"	plug with dust seal and chain assembly, yellow	<b>ME179-1</b>	<b>\$34.15</b>
2 1/4"	plug with dust seal and chain assembly, yellow	<b>ME180-1</b>	<b>41.50</b>
3 1/4"	plug with dust seal and chain assembly, yellow	<b>ME181-1</b>	<b>90.30</b>



## Instrumentation Fittings

**Applications:**

- high pressure
- high temperature
- nitrogen
- helium
- flammable gases
- hydraulic gases
- corrosive media
- pneumatic automation

**Features:**

- Instrumentation fittings come completely assembled.
- fully interchangeable with Swagelok® and Parker A-Lok® all fittings are ASTM F 1387 Certified
- double collet (ferrule) swaging action
- two positive seal points
- ASTM 316 stainless steel material construction
- temperature range: **-325°F to 1200°F (-198°C to 648°C)**
- pressure ratings: see chart to the left, ratings listed are for reference only

**Installation Instructions:**

1. Cut tubing squarely and clean tube end thoroughly to remove burrs.
2. Insert the tubing into the assembly making sure the tubing seats firm against the shoulder of the body and the nut is finger tight.
3. Tighten the nut with a wrench 1¼ turns, while holding the body with a second wrench.

**Suggested Working Pressures (PSI)**

wall thk.	.028	.035	.049	.065	.083	.095	.109
¼"	<b>4,000</b>	<b>5,100</b>	<b>7,500</b>	<b>10,100</b>	---	---	---
⅜"	---	<b>3,300</b>	<b>4,700</b>	<b>6,600</b>	---	---	---
½"	---	<b>2,600</b>	<b>3,700</b>	<b>5,000</b>	<b>6,600</b>	---	---
⅝"	---	---	<b>2,900</b>	<b>3,900</b>	<b>5,200</b>	<b>6,000</b>	---
¾"	---	---	<b>2,400</b>	<b>3,200</b>	<b>4,200</b>	<b>4,900</b>	<b>5,700</b>

**Safety Guidelines:**

- Never connect, disconnect or remake a fitting with pressure in the system.
- Make sure all fittings are properly installed.
- It is not recommended to go beyond the pressure rating of the tubing. Elongation could occur in the tubing, shrinking the wall thickness and causing potential harm.
- For proper sealing it is recommended that the tubing and fittings be of like material.
- Always use proper thread lubricant and sealants on tapered pipe threads.
- Never bleed a system by loosening a fitting.

**Male Connectors**

Tube OD	Male NPT	Interchanges	316 Stainless Steel		Pkg Qty
			Part #	Price/E	
⅛"	⅛"-27	200-1-2	<b>2-DMC-2</b>	<b>\$15.90</b>	10
	¼"-18	200-1-4	<b>2-DMC-4</b>	<b>16.80</b>	10
¼"	⅛"-27	400-1-2	<b>4-DMC-2</b>	<b>15.20</b>	10
	¼"-18	400-1-4	<b>4-DMC-4</b>	<b>16.55</b>	10
	⅜"-18	400-1-6	<b>4-DMC-6</b>	<b>18.65</b>	10
	½"-14	400-1-8	<b>4-DMC-8</b>	<b>24.75</b>	10
⅜"	¼"-18	600-1-4	<b>6-DMC-4</b>	<b>19.50</b>	10
	⅜"-18	600-1-6	<b>6-DMC-6</b>	<b>22.05</b>	10
	½"-14	600-1-8	<b>6-DMC-8</b>	<b>26.55</b>	10
½"	¼"-18	810-1-4	<b>8-DMC-4</b>	<b>28.90</b>	10
	⅜"-18	810-1-6	<b>8-DMC-6</b>	<b>29.70</b>	10
	½"-14	810-1-8	<b>8-DMC-8</b>	<b>33.10</b>	10
⅝"	½"-14	1010-1-8	<b>10-DMC-8</b>	<b>44.85</b>	10
¾"	½"-14	1210-1-8	<b>12-DMC-8</b>	<b>60.40</b>	10
	¾"	1210-1-12	<b>12-DMC-12</b>	<b>60.40</b>	10
	1"	1210-1-16	<b>12-DMC-16</b>	<b>83.00</b>	10
1"	¾"	1610-1-12	<b>16-DMC-12</b>	<b>105.00</b>	10
	1"	1610-1-16	<b>16-DMC-16</b>	<b>138.00</b>	10



**Female Connectors**

Tube OD	Female NPT	Interchanges	316 Stainless Steel		Pkg Qty
			Part #	Price/E	
⅛"	⅛"-27	200-7-2	<b>2-DFC-2</b>	<b>\$18.90</b>	10
¼"	⅛"-27	400-7-2	<b>4-DFC-2</b>	<b>18.70</b>	10
	¼"-18	400-7-4	<b>4-DFC-4</b>	<b>23.10</b>	10
⅜"	¼"-18	600-7-4	<b>6-DFC-4</b>	<b>23.95</b>	10
	½"-14	600-7-8	<b>6-DFC-8</b>	<b>41.50</b>	10
½"	½"-14	810-7-8	<b>8-DFC-8</b>	<b>46.25</b>	10
⅝"	½"	1010-7-8	<b>10-DFC-8</b>	<b>54.00</b>	10
¾"	½"	1210-7-8	<b>12-DFC-8</b>	<b>62.00</b>	10
	¾"	1210-7-12	<b>12-DFC-12</b>	<b>73.00</b>	10
1"	1"	1610-7-16	<b>16-DFC-16</b>	<b>134.00</b>	10



## Instrumentation Fittings

## Unions

Pipe, Welding  
& Tube Fittings

Tube OD	Interchanges	316 Stainless Steel		Pkg Qty
		Part #	Price/E	
1/8" x 1/8"	200-6	<b>2-DU</b>	<b>\$22.75</b>	10
1/4" x 1/8"	400-6-2	<b>4-DU-2</b>	<b>24.00</b>	10
1/4" x 1/4"	400-6	<b>4-DU</b>	<b>23.85</b>	10
3/8" x 1/4"	600-6-4	<b>6-DU-4</b>	<b>33.10</b>	10
3/8" x 3/8"	600-6	<b>6-DU</b>	<b>33.10</b>	10
1/2" x 1/2"	810-6	<b>8-DU</b>	<b>50.00</b>	10
5/8" x 5/8"	1010-6	<b>10-DU</b>	<b>72.00</b>	10
3/4" x 3/4"	1210-6	<b>12-DU</b>	<b>97.00</b>	10
1" x 1"	1610-6	<b>16-DU</b>	<b>190.00</b>	10

## Bulkhead Unions



Tube OD	Interchanges	316 Stainless Steel		Pkg Qty
		Part #	Price/E	
1/4"	400-61	<b>4-DBHU-4</b>	<b>\$32.85</b>	10
3/8"	600-61	<b>6-DBHU-6</b>	<b>47.55</b>	10
1/2"	810-61	<b>8-DBHU-8</b>	<b>75.90</b>	10
5/8"	1010-61	<b>10-DBHU-10</b>	<b>98.00</b>	10
3/4"	1210-16	<b>12-DBHU-12</b>	<b>124.00</b>	10
1"	1610-16	<b>16-DBHU-16</b>	<b>242.00</b>	10

## Reducers



Tube OD	Interchanges	316 Stainless Steel		Pkg Qty
		Part #	Price/E	
1/4" x 1/8"	400-R-2	<b>4-DRATT-2</b>	<b>\$24.50</b>	10
3/8" x 1/4"	600-R-4	<b>6-DRATT-4</b>	<b>24.50</b>	10
3/8" x 1/2"	600-R-8	<b>6-DRATT-8</b>	<b>25.25</b>	10
1/2" x 3/4"	810-R-12	<b>8-DRATT-12</b>	<b>32.05</b>	10
3/4" x 1/2"	1210-R-8	<b>12-DRATT-8</b>	<b>62.25</b>	10
3/4" x 1"	1210-R-16	<b>12-DRATT-16</b>	<b>68.00</b>	10

## Male Elbows



Tube OD	Male NPT	Interchanges	316 Stainless Steel		Pkg Qty
			Part #	Price/E	
1/4"	1/8"-27	400-2-2	<b>4-DME-2</b>	<b>\$28.30</b>	10
	1/4"-18	400-2-4	<b>4-DME-4</b>	<b>28.30</b>	10
3/8"	1/4"-18	600-2-4	<b>6-DME-4</b>	<b>33.95</b>	10
	3/8"-18	600-2-6	<b>6-DME-6</b>	<b>40.75</b>	10
1/2"	1/2"-14	810-2-8	<b>8-DME-8</b>	<b>59.95</b>	10
3/4"	1/2"-14	1210-2-8	<b>12-DME-8</b>	<b>92.45</b>	10
	3/4"	1210-2-12	<b>12-DME-12</b>	<b>103.10</b>	10
1"	3/4"	1610-2-12	<b>16-DME-12</b>	<b>206.00</b>	10
	1"	1610-2-16	<b>16-DME-16</b>	<b>186.00</b>	10

## Female Elbows



Tube OD	Female NPT	Interchanges	316 Stainless Steel		Pkg Qty
			Part #	Price/E	
1/4"	1/8"-27	400-8-2	<b>4-DFE-2</b>	<b>\$40.70</b>	10
3/8"	1/4"-18	600-8-4	<b>6-DFE-4</b>	<b>41.35</b>	10
1/2"	1/2"-14	810-8-8	<b>8-DFE-8</b>	<b>80.00</b>	10
3/4"	1/2"	1210-8-8	<b>12-DFE-8</b>	<b>120.00</b>	10
3/4"	3/4"	1210-8-12	<b>12-DFE-12</b>	<b>163.00</b>	10
1"	1"	1610-8-16	<b>16-DFE-16</b>	<b>276.00</b>	10

Instrumentation Fittings

Union Elbows

Tube OD	Interchanges	316 Stainless Steel		Pkg Qty
		Part #	Price/E	
1/4"	400-9	<b>4-DELU-4</b>	<b>\$38.70</b>	10
3/8"	600-9	<b>6-DELU-6</b>	<b>43.50</b>	10
1/2"	810-9	<b>8-DELU-8</b>	<b>65.10</b>	10
5/8"	1010-9	<b>10-DELU-10</b>	<b>97.00</b>	10
3/4"	1210-9	<b>12-DELU-12</b>	<b>130.00</b>	10
1"	1610-9	<b>16-DELU-16</b>	<b>256.00</b>	10



Pipe, Welding & Tube Fittings

Male Branch Tees

Tube OD	Male NPT	Interchanges	316 Stainless Steel		Pkg Qty
			Part #	Price/E	
1/8"	1/8"-27	200-3TTM	<b>2-DTTM-2</b>	<b>\$49.00</b>	10
1/4"	1/4"-18	400-3-4TTM	<b>4-DTTM-4</b>	<b>56.00</b>	10
1/2"	3/8"	810-3TTM	<b>8-DTTM-6</b>	<b>90.00</b>	10
1/2"	1/2"	810-3-8TTM	<b>8-DTTM-8</b>	<b>96.00</b>	10
3/4"	1/2"	1210-3-8TTM	<b>12-DTTM-8</b>	<b>294.00</b>	10
3/4"	3/4"	1210-3TTM	<b>12-DTTM-12</b>	<b>151.00</b>	10
1"	3/4"	1610-3-12TTM	<b>16-DTTM-12</b>	<b>560.00</b>	10
1"	1"	1610-3-16TTM	<b>16-DTTM-16</b>	<b>650.00</b>	10



Female Branch Tees

Tube OD	Female NPT	Interchanges	316 Stainless Steel		Pkg Qty
			Part #	Price/E	
1/4"	1/4"-18	400-3-4TTF	<b>4-DTTF-4</b>	<b>\$65.00</b>	10



Union Tees

Tube OD	Interchanges	316 Stainless Steel		Pkg Qty
		Part #	Price/E	
1/4"	400-3	<b>4-DTTT-4</b>	<b>\$55.20</b>	10
3/8"	600-3	<b>6-DTTT-6</b>	<b>76.20</b>	10
1/2"	810-3	<b>8-DTTT-8</b>	<b>109.10</b>	10
5/8"	1010-3	<b>10-DTTT-10</b>	<b>145.00</b>	10
3/4" x 3/8"	1210-3-12-6	<b>12-DTTT-6</b>	<b>235.00</b>	10
3/4" x 1/2"	1210-3-12-8	<b>12-DTTT-8</b>	<b>235.00</b>	10
3/4"	1210-3	<b>12-DTTT-12</b>	<b>191.00</b>	10
1" x 3/4"	1610-3-12-16	<b>16-DTTT-12</b>	<b>500.00</b>	10
1"	1610-3	<b>16-DTTT-16</b>	<b>440.00</b>	10



Male Run Tees

Tube OD	Male NPT	Interchanges	316 Stainless Steel		Pkg Qty
			Part #	Price/E	
1/8"	1/8"-27	200-3TMT	<b>2-DTMT-2</b>	<b>\$49.00</b>	10
1/4"	1/4"-18	400-3-4TMT	<b>4-DTMT-4</b>	<b>56.00</b>	10
3/8"	1/4"-18	600-3TMT	<b>6-DTMT-4</b>	<b>59.40</b>	10
1/2"	3/8"	810-3TMT	<b>8-DTMT-6</b>	<b>90.00</b>	10
1/2"	1/2"	810-3-8TMT	<b>8-DTMT-8</b>	<b>96.00</b>	10
3/4"	3/4"	1210-3TMT	<b>12-DTMT-12</b>	<b>152.00</b>	10
1"	1"	1610-3-16TMT	<b>16-DTMT-16</b>	<b>650.00</b>	10



Instrumentation Fittings

Front Ferrules



Tube OD	Interchanges	316 Stainless Steel		Pkg Qty
		Part #	Price/E	
1/8"	203-1	<b>DFC-2</b>	<b>\$2.95</b>	10
1/4"	403-1	<b>DFC-4</b>	<b>3.15</b>	10
3/8"	603-1	<b>DFC-6</b>	<b>3.20</b>	10
1/2"	813-1	<b>DFC-8</b>	<b>3.90</b>	10
5/8"	1013-1	<b>DFC-10</b>	<b>5.85</b>	10
3/4"	1213-1	<b>DFC-12</b>	<b>8.30</b>	10
1"	1613-1	<b>DFC-16</b>	<b>17.00</b>	10

Rear Ferrules



Tube OD	Interchanges	316 Stainless Steel		Pkg Qty
		Part #	Price/E	
1/8"	204-1	<b>DRC-2</b>	<b>\$2.45</b>	10
1/4"	404-1	<b>DRC-4</b>	<b>2.40</b>	10
3/8"	604-1	<b>DRC-6</b>	<b>2.95</b>	10
1/2"	814-1	<b>DRC-8</b>	<b>3.85</b>	10
5/8"	1014-1	<b>DRC-10</b>	<b>13.80</b>	10
3/4"	1214-1	<b>DRC-12</b>	<b>15.50</b>	10
1"	1614-1	<b>DRC-16</b>	<b>41.00</b>	10

Nuts



Tube OD	Interchanges	316 Stainless Steel		Pkg Qty
		Part #	Price/E	
1/4"	402-1	<b>DN-4</b>	<b>\$4.50</b>	10
3/8"	602-1	<b>DN-6</b>	<b>6.25</b>	10
1/2"	812-1	<b>DN-8</b>	<b>10.00</b>	10
5/8"	1012-1	<b>DN-10</b>	<b>13.10</b>	10
3/4"	1212-1	<b>DN-12</b>	<b>16.50</b>	10
1"	1612-1	<b>DN-16</b>	<b>30.00</b>	10

Caps



Tube OD	Interchanges	316 Stainless Steel		Pkg Qty
		Part #	Price/E	
1/4"	400-C	<b>4-DCAP</b>	<b>\$12.75</b>	10
3/8"	600-C	<b>6-DCAP</b>	<b>15.90</b>	10
1/2"	810-C	<b>8-DCAP</b>	<b>26.45</b>	10
5/8"	1010-C	<b>10-DCAP</b>	<b>35.00</b>	10
3/4"	1210-C	<b>12-DCAP</b>	<b>48.00</b>	10
1"	1610-C	<b>16-DCAP</b>	<b>105.00</b>	10

Plugs



Tube OD	Interchanges	316 Stainless Steel		Pkg Qty
		Part #	Price/E	
1/4"	400-P	<b>4-DFPLUG</b>	<b>\$11.10</b>	10
3/8"	600-P	<b>6-DFPLUG</b>	<b>12.80</b>	10
1/2"	810-P	<b>8-DFPLUG</b>	<b>19.00</b>	10
5/8"	1010-P	<b>10-DFPLUG</b>	<b>25.25</b>	10
3/4"	1210-P	<b>12-DFPLUG</b>	<b>31.00</b>	10
1"	1610-P	<b>16-DFPLUG</b>	<b>62.00</b>	10

## Compression Fittings

### Applications:

- for use with copper, aluminum and Parflex thermoplastic tubing
- not recommended for steel tubing or applications using gaseous media

### Features:

- no flaring, soldering or other preparation of tubing necessary to assemble
- manufactured for connection to low and medium pressure tubing connection work where excessive vibration or tube movement is not involved
- Underwriter's Laboratories listed for flammable liquid
- Compression fittings meet functional requirements of SAE J-512 and ASA.

### Assembly Instructions:

1. Slide nut, then sleeve onto tubing. The thread end of the nut must face outward.
2. Insert the tube into the fitting. Be sure the tube is bottomed on the fitting shoulder.
3. Assemble nut to body, than tighten hand-tight. Then follow the number of wrench turns as indicated in the table below.

Fitting Size	Tube OD	Tube Wall	Turns required to seal from hand-tight		PSI @ 73°F (23°C)
			60C Series with soft metal tubing	60PT Series with thermoplastic tubing	
2"	1/8"	.030	1¼	-	400
3"	3/16"	.030	1¼	-	400
4"	1/4"	.030	1¼	2	300
5"	5/16"	.032	1¼	2	300
6"	3/8"	.032	2¼	2	200
8"	1/2"	.032	2¼	2	200
10"	5/8"	.035	2¼	2	150
12"	3/4"	.035	2¼	2	100
14"	7/8"	.035	2¼	-	75

### Male Connectors

#### Feature:

- reference SAE 060102 BA

Tube Size	Pipe Thread	Brass	
		Part #	Price/E
1/8"	1/8"	<b>68C-0202</b>	<b>\$3.55</b>
3/16"	1/8"	<b>68C-0302</b>	<b>3.55</b>
3/16"	1/4"	<b>68C-0304</b>	<b>6.10</b>
1/4"	1/8"	<b>68C-0402</b>	<b>2.97</b>
1/4"	1/4"	<b>68C-0404</b>	<b>4.31</b>
1/4"	3/8"	<b>68C-0406</b>	<b>6.75</b>
1/4"	1/2"	<b>68C-0408</b>	<b>10.87</b>
5/16"	1/8"	<b>68C-0502</b>	<b>5.50</b>
5/16"	1/4"	<b>68C-0504</b>	<b>4.75</b>
3/8"	1/8"	<b>68C-0602</b>	<b>4.45</b>
3/8"	1/4"	<b>68C-0604</b>	<b>4.76</b>
3/8"	3/8"	<b>68C-0606</b>	<b>6.07</b>
3/8"	1/2"	<b>68C-0608</b>	<b>8.67</b>
7/16"	1/4"	<b>68C-0704</b>	<b>13.50</b>
1/2"	1/4"	<b>68C-0804</b>	<b>9.24</b>
1/2"	3/8"	<b>68C-0806</b>	<b>10.80</b>
1/2"	1/2"	<b>68C-0808</b>	<b>10.78</b>
5/8"	3/8"	<b>68C-1006</b>	<b>14.41</b>
5/8"	1/2"	<b>68C-1008</b>	<b>13.58</b>
5/8"	3/4"	<b>68C-1012</b>	<b>23.72</b>
3/4"	1/2"	<b>68C-1208</b>	<b>22.19</b>
3/4"	3/4"	<b>68C-1212</b>	<b>28.30</b>
7/8"	3/4"	<b>68C-1412</b>	<b>27.75</b>



Compression Fittings

Female Connectors

Feature:

- reference SAE 060103 BA



Tube Size	Pipe Thread	Brass	
		Part #	Price/E
1/8"	1/8"	66C-0202	\$5.91
3/16"	1/8"	66C-0302	5.40
3/16"	1/4"	66C-0304	16.02
1/4"	1/8"	66C-0402	3.55
1/4"	1/4"	66C-0404	8.78
5/16"	1/8"	66C-0502	7.95
5/16"	1/4"	66C-0504	14.85
3/8"	1/8"	66C-0602	5.50
3/8"	1/4"	66C-0604	8.76
3/8"	3/8"	66C-0606	9.27
3/8"	1/2"	66C-0608	14.15
1/2"	1/4"	66C-0804	15.66
1/2"	3/8"	66C-0806	12.95
1/2"	1/2"	66C-0808	19.31
5/8"	1/2"	66C-1008	18.75

Unions

Feature:

- reference SAE 060101 BA



Tube Size	Brass	
	Part #	Price/E
1/8"	62C-02	\$6.65
3/16"	62C-03	4.86
1/4"	62C-04	4.50
5/16"	62C-05	6.33
3/8"	62C-06	5.67
7/16"	62C-07	28.07
1/2"	62C-08	13.42
5/8"	62C-10	18.18
3/4"	62C-12	37.82
7/8"	62C-14	44.20

Union Reducers

Feature:

- reference SAE 060101 BA



Tube Size	Brass	
	Part #	Price/E
3/16" x 1/4"	62C-0403	\$13.15
1/4" x 3/8"	62C-0604	13.01
3/8" x 1/2"	62C-0806	24.82
3/8" x 5/8"	62C-1006	17.85

Bulkhead Unions



Tube Size	Brass	
	Part #	Price/E
1/4"	62CBH-04	\$13.73
3/8"	62CBH-06	27.06



Compression Fittings  
Straight Through Tank Fittings

Tube Size	Pipe Thread	Brass	
		Part #	Price/E
3/16"	1/8"	682C-0302	\$12.45
3/8"	3/8"	682C-0606	17.98
1/2"	1/2"	682C-0808	24.05



Female Elbows

Feature:

- reference SAE 060203 BA

Tube Size	Pipe Thread	Brass	
		Part #	Price/E
1/8"	1/8"	170C-0202	\$11.33
3/16"	1/8"	170C-0302	13.00
1/4"	1/8"	170C-0402	10.26
1/4"	1/4"	170C-0404	15.29
3/8"	1/4"	170C-0604	16.11
3/8"	3/8"	170C-0606	18.82
7/16"	1/4"	170C-0704	28.00
1/2"	3/8"	170C-0806	19.66



Male Elbows

Feature:

- reference SAE 060202 BA

Tube Size	Pipe Thread	Brass	
		Part #	Price/E
1/8"	1/8"	269C-0202	\$6.17
3/16"	1/8"	169C-0302	9.07
3/16"	1/4"	169C-0304	17.86
1/4"	1/8"	169C-0402	7.30
1/4"	1/4"	169C-0404	7.56
1/4"	3/8"	169C-0406	18.18
5/16"	1/8"	169C-0502	12.10
5/16"	1/4"	169C-0504	12.20
5/16"	3/8"	169C-0506	27.03
3/8"	1/8"	169C-0602	10.61
3/8"	1/4"	169C-0604	8.30
3/8"	3/8"	169C-0606	10.22
3/8"	1/2"	169C-0608	18.07
1/2"	1/4"	169C-0804	19.97
1/2"	3/8"	169C-0806	14.96
1/2"	1/2"	169C-0808	19.92
5/8"	1/2"	169C-1008	24.55
3/4"	1/2"	169C-1208	39.85
3/4"	3/4"	169C-1212	39.85



45° Elbows

Tube Size	Pipe Thread	Brass	
		Part #	Price/E
1/4"	1/8"	179C-0402	\$13.24
1/4"	1/4"	179C-0404	15.55
3/8"	1/8"	179C-0602	24.56
3/8"	1/4"	179C-0604	17.92
3/8"	3/8"	179C-0606	24.68
1/2"	3/8"	179C-0806	30.38



## Compression Fittings

## Union Elbows

## Feature:

- reference SAE 060201 BA



Tube Size	Brass	
	Part #	Price/E
1/8"	<b>165C-02</b>	<b>\$19.10</b>
3/16"	<b>165C-03</b>	<b>10.26</b>
1/4"	<b>165C-04</b>	<b>10.51</b>
5/16"	<b>165C-05</b>	<b>16.22</b>
3/8"	<b>165C-06</b>	<b>9.85</b>
7/16"	<b>165C-07</b>	<b>23.85</b>
1/2"	<b>165C-08</b>	<b>23.10</b>
5/8"	<b>165C-10</b>	<b>27.27</b>
3/4"	<b>165C-12</b>	<b>53.87</b>

## Male Branch Tees

## Feature:

- reference SAE 060425 BA



Tube Size	Pipe Thread	Brass	
		Part #	Price/E
1/8"	1/8"	<b>172C-0202</b>	<b>\$15.40</b>
3/16"	1/8"	<b>172C-0302</b>	<b>15.36</b>
1/4"	1/8"	<b>172C-0402</b>	<b>10.75</b>
1/4"	1/4"	<b>172C-0404</b>	<b>13.75</b>
3/8"	1/8"	<b>172C-0602</b>	<b>18.00</b>
3/8"	1/4"	<b>172C-0604</b>	<b>14.90</b>
3/8"	3/8"	<b>172C-0606</b>	<b>22.00</b>
1/2"	3/8"	<b>172C-0806</b>	<b>26.46</b>

## Female Branch Tee



Tube Size	Pipe Thread	Brass	
		Part #	Price/E
1/4"	1/8"	<b>177C-0402</b>	<b>\$17.19</b>

## Union Tees

## Feature:

- reference SAE 060401 BA



Tube Size 1 and 2	Tube Size 3	Brass	
		Part #	Price/E
1/8"	1/8"	<b>164C-02</b>	<b>\$20.87</b>
3/16"	3/16"	<b>264C-03</b>	<b>16.62</b>
1/4"	1/4"	<b>164C-04</b>	<b>11.30</b>
5/16"	5/16"	<b>164C-05</b>	<b>17.25</b>
3/8"	3/8"	<b>164C-06</b>	<b>14.90</b>
1/2"	1/2"	<b>164C-08</b>	<b>28.65</b>
5/8"	5/8"	<b>164C-10</b>	<b>47.45</b>
3/4"	3/4"	<b>164C-12</b>	<b>102.65</b>
3/8"	1/4"	<b>164C-06-06-04</b>	<b>18.34</b>
1/2"	3/8"	<b>164C-08-08-06</b>	<b>71.60</b>

Compression Fittings

Male Run Tees

Feature:

- reference SAE 060424 BA

Tube Size	Pipe Thread	Brass	
		Part #	Price/E
3/16"	1/8"	<b>171C-0302</b>	<b>\$15.95</b>
1/8"	1/8"	<b>171C-0202</b>	<b>15.95</b>
1/4"	1/8"	<b>171C-0402</b>	<b>12.10</b>
1/4"	1/4"	<b>171C-0404</b>	<b>14.40</b>
3/8"	1/4"	<b>171C-0604</b>	<b>17.00</b>



Pipe, Welding  
& Tube Fittings

Adapter Tee

Tube Size	Male Pipe Thread	Female Straight Thread	Brass	
			Part #	Price/E
1/4"	1/8"	7/16"-24	<b>176C-0402</b>	<b>\$12.45</b>



Seal Plug

Tube Size	Brass	
	Part #	Price/E
1/4"	<b>639C-04</b>	<b>\$4.32</b>



Inserts

Tube Size	Wall Thickness	Brass	
		Part #	Price/E
1/8"	.016"	<b>63PT-0216</b>	<b>\$0.96</b>
1/8"	.023"	<b>63PT-0223</b>	<b>1.15</b>
3/16"	.025"	<b>63PT-0325</b>	<b>1.05</b>
3/16"	.040"	<b>63PT-0340</b>	<b>0.86</b>
1/4"	.040"	<b>63PT-0440</b>	<b>0.72</b>
1/4"	.062"	<b>63PT-0462</b>	<b>1.25</b>
5/16"	.040"	<b>63PT-0540</b>	<b>1.80</b>
5/16"	.062"	<b>63PT-0562</b>	<b>1.12</b>
3/8"	.062"	<b>63PT-0662</b>	<b>0.80</b>
1/2"	.062"	<b>63PT-0862</b>	<b>1.06</b>
5/8"	.062"	<b>63PT-1062</b>	<b>2.11</b>



- Acetal sleeves and brass inserts allow for standard compression fittings to be used with industrial grades of thermoplastic tubing.

Brass Sleeves

Feature:

- reference SAE 060115

Tube Size	Brass	
	Part #	Price/E
1/8"	<b>60C-02</b>	<b>\$0.72</b>
3/16"	<b>60C-03</b>	<b>0.72</b>
1/4"	<b>60C-04</b>	<b>0.72</b>
5/16"	<b>60C-05</b>	<b>0.72</b>
3/8"	<b>60C-06</b>	<b>0.72</b>
7/16"	<b>60C-07</b>	<b>2.79</b>
1/2"	<b>60C-08</b>	<b>1.07</b>
5/8"	<b>60C-10</b>	<b>1.45</b>
3/4"	<b>60C-12</b>	<b>1.98</b>
7/8"	<b>60C-14</b>	<b>4.14</b>



## Compression Fittings



## Acetal Sleeves

Tube Size	Acetal	
	Part #	Price/E
1/4"	<b>60PT-04</b>	<b>\$0.76</b>
5/16"	<b>60PT-05</b>	<b>0.96</b>
3/8"	<b>60PT-06</b>	<b>0.86</b>
1/2"	<b>60PT-08</b>	<b>1.06</b>
5/8"	<b>60PT-10</b>	<b>1.55</b>

- Acetal sleeves and brass inserts allow for standard compression fittings to be used with industrial grades of thermoplastic tubing.

## Nuts

## Feature:

- reference SAE 060110



Tube Size	Straight Thread	Brass	
		Part #	Price/E
1/8"	5/16"-24	<b>61C-02</b>	<b>\$1.11</b>
3/16"	3/8"-24	<b>61C-03</b>	<b>1.20</b>
1/4"	7/16"-24	<b>61C-04</b>	<b>1.15</b>
5/16"	1/2"-24	<b>61C-05</b>	<b>1.55</b>
3/8"	9/16"-24	<b>61C-06</b>	<b>1.39</b>
7/16"	5/8"-24	<b>61C-07</b>	<b>3.33</b>
1/2"	11/16"-20	<b>61C-08</b>	<b>2.97</b>
5/8"	13/16"-18	<b>61C-10</b>	<b>5.40</b>
3/4"	1"-18	<b>61C-12</b>	<b>9.49</b>
7/8"	1-1/8"-18	<b>61C-14</b>	<b>10.92</b>

## Long Nuts

## Feature:

- reference SAE 060111



Tube Size	Straight Thread	Brass	
		Part #	Price/E
1/4"	7/16"-24	<b>61CL-04</b>	<b>\$2.86</b>
5/16"	1/2"-24	<b>61CL-05</b>	<b>13.50</b>
3/8"	9/16"-24	<b>61CL-06</b>	<b>4.95</b>
1/2"	11/16"-20	<b>61CL-08</b>	<b>10.38</b>
5/8"	13/16"-18	<b>61CL-10</b>	<b>18.52</b>
3/4"	1"-18	<b>61CL-12</b>	<b>18.90</b>

## Brass SAE 45° Flare Fittings

### Applications:

- for use with copper, brass, aluminum and welded steel hydraulic tubing that can be flared

### Features:

- economical fitting
- resists mechanical pullout
- easy to disassemble and may be reassembled repeatedly, for a leak-proof connection
- manufactured from CA 360, CA 345, or CA377 brass
- for use with hard-to-hold liquids and gases
- Listed with Underwriter's Laboratories for flammable liquid, marine, refrigeration and gas applications. Meets functional requirements of SAE J512 and J513, ASA and MS (Military Standards).
- temperature range: **-65°F to 250°F (-54°C to 121°C)**

### Working Pressure Ranges:

Temperature and type of tubing used are important factors, the following table is a general guide for proper selection. The PSI rating given is based on a temperature of **73°F (22°C)** using copper tubing.

PSI	Tube OD	Tube Wall
<b>1400</b>	1/4"	.030
<b>1000</b>	3/8"	.032
<b>750</b>	1/2"	.032
<b>650</b>	5/8"	.035
<b>550</b>	3/4"	.035

### Assembly Instructions:

1. Cut tubing squarely and clean tube end thoroughly to remove burrs.
2. Place nut onto tube. Place threaded end of nut toward end of tube.
3. Flare tube end with flaring tool to provide 45° flare (flare tools are available, please contact Dixon® for pricing and availability).
4. Clamp tube flare between nut and nose of fitting body by screwing nut on finger-tight. Tighten with a wrench an additional 1/4 turn for a metal-to-metal seal.

### Male Connectors

#### Feature:

- reference SAE 010102

Tube Size	Pipe Size	Straight Thread	Hex	Brass	
				Part #	Price/E
1/4"	1/4"	7/16"-20	9/16"	<b>48F-4-4</b>	<b>\$2.55</b>
1/4"	3/8"	7/16"-20	11/16"	<b>48F-4-6</b>	<b>4.45</b>
1/4"	1/2"	7/16"-20	7/8"	<b>48F-4-8</b>	<b>12.35</b>
3/8"	1/8"	5/8"-18	5/8"	<b>48F-6-2</b>	<b>4.60</b>
3/8"	1/4"	5/8"-18	5/8"	<b>48F-6-4</b>	<b>3.50</b>
3/8"	3/8"	5/8"-18	11/16"	<b>48F-6-6</b>	<b>4.00</b>
3/8"	1/2"	5/8"-18	7/8"	<b>48F-6-8</b>	<b>5.90</b>
1/2"	1/4"	3/4"-16	3/4"	<b>48F-8-4</b>	<b>7.30</b>
1/2"	3/8"	3/4"-16	3/4"	<b>48F-8-6</b>	<b>4.80</b>
1/2"	1/2"	3/4"-16	7/8"	<b>48F-8-8</b>	<b>6.45</b>
5/8"	3/8"	7/8"-14	7/8"	<b>48F-10-6</b>	<b>6.95</b>
3/4"	3/4"	1-1/16"-14	1-1/16"	<b>48F-12-12</b>	<b>13.50</b>



### Female Connectors

#### Feature:

- reference SAE 010103

Tube Size	Pipe Size	Straight Thread	Hex	Brass	
				Part #	Price/E
1/4"	1/4"	7/16"-20	11/16"	<b>46F-4-4</b>	<b>\$4.30</b>
3/8"	1/4"	5/8"-18	11/16"	<b>46F-6-4</b>	<b>4.95</b>
3/8"	3/8"	5/8"-18	13/16"	<b>46F-6-6</b>	<b>7.65</b>
3/8"	1/2"	5/8"-18	1"	<b>46F-6-8</b>	<b>12.50</b>
1/2"	1/4"	3/4"-16	3/4"	<b>46F-8-4</b>	<b>7.70</b>
1/2"	3/8"	3/4"-16	13/16"	<b>46F-8-6</b>	<b>7.45</b>
5/8"	3/8"	7/8"-14	7/8"	<b>46F-10-6</b>	<b>11.80</b>



## Brass SAE 45° Flare Fittings

## Unions



## Feature:

- reference SAE 010101

Tube Size	Straight Thread	Hex	Brass	
			Part #	Price/E
1/4"	7/16"-20	7/16"	<b>42F-4</b>	<b>\$2.05</b>
3/8"	5/8"-18	5/8"	<b>42F-6</b>	<b>4.80</b>
1/2"	3/4"-16	3/4"	<b>42F-8</b>	<b>5.95</b>

## Male Elbows

## Feature:

- reference SAE 010202



Tube Size	Pipe Size	Straight Thread	Brass	
			Part #	Price/E
1/4"	1/8"	7/16"-20	<b>149F-4-2</b>	<b>\$4.60</b>
1/4"	1/4"	7/16"-20	<b>149F-4-4</b>	<b>6.55</b>
1/4"	3/8"	7/16"-20	<b>149F-4-6</b>	<b>12.25</b>
3/8"	1/4"	5/8"-18	<b>149F-6-4</b>	<b>7.90</b>
3/8"	3/8"	5/8"-18	<b>149F-6-6</b>	<b>9.20</b>
3/8"	1/2"	5/8"-18	<b>149F-6-8</b>	<b>11.60</b>
1/2"	1/4"	3/4"-16	<b>149F-8-4</b>	<b>11.90</b>
1/2"	3/8"	3/4"-16	<b>149F-8-6</b>	<b>8.85</b>
1/2"	1/2"	3/4"-16	<b>149F-8-8</b>	<b>9.60</b>
5/8"	1/2"	7/8"-14	<b>149F-10-8</b>	<b>12.30</b>
3/4"	3/4"	1-1/16"-14	<b>149F-12-12</b>	<b>22.15</b>

## Female Elbows

## Feature:

- reference SAE 010203



Tube Size	Pipe Size	Straight Thread	Brass	
			Part #	Price/E
1/4"	1/4"	7/16"-20	<b>150F-4-4</b>	<b>\$11.10</b>
3/8"	3/8"	5/8"-18	<b>150F-6-6</b>	<b>14.95</b>
3/8"	1/2"	5/8"-18	<b>150F-6-8</b>	<b>24.95</b>

## 90° Swivel Elbows



Tube Size	Straight Thread	Brass	
		Part #	Price/E
1/4"	7/16"-20	<b>166FSV-4-4</b>	<b>\$13.45</b>
3/8"	5/8"-18	<b>166FSV-6-6</b>	<b>16.85</b>
1/2"	3/4"-16	<b>166FSV-8-8</b>	<b>22.50</b>



## Brass SAE 45° Flare Fittings

### 45° Elbows

**Feature:**

- reference SAE 010302

Tube Size	Pipe Size	Straight Thread	Brass	
			Part #	Price/E
1/4"	1/4"	7/16"-20	<b>159F-4-4</b>	<b>\$10.10</b>
3/8"	1/4"	5/8"-18	<b>159F-6-4</b>	<b>7.70</b>
3/8"	3/8"	5/8"-18	<b>159F-6-6</b>	<b>7.05</b>
1/2"	1/4"	3/4"-16	<b>159F-8-4</b>	<b>21.50</b>
1/2"	3/8"	3/4"-16	<b>159F-8-6</b>	<b>7.45</b>
1/2"	1/2"	3/4"-16	<b>159F-8-8</b>	<b>13.95</b>



Pipe, Welding  
& Tube Fittings

### Union Tees

**Feature:**

- reference SAE 010401

Tube Size	Straight Thread	Brass	
		Part #	Price/E
1/4"	7/16"-20	<b>144F-4</b>	<b>\$7.60</b>
3/8"	5/8"-18	<b>144F-6</b>	<b>13.00</b>
1/2"	3/4"-16	<b>144F-8</b>	<b>15.85</b>



### Short Nuts

**Features:**

- short nut for use when vibration is minimal
- reference SAE 010110

Tube Size	Straight Thread	Hex	Brass	
			Part #	Price/E
1/4"	7/16"-20	9/16"	<b>41FS-4</b>	<b>\$1.95</b>
3/8"	5/8"-18	3/4"	<b>41FS-6</b>	<b>3.45</b>
1/2"	3/4"-16	7/8"	<b>41FS-8</b>	<b>4.85</b>



### Long Nuts

**Features:**

- long nut offers additional vibration capacity
- reference SAE 010111

Tube Size	Straight Thread	Hex	Brass	
			Part #	Price/E
1/4"	7/16"-20	9/16"	<b>41FL-4</b>	<b>\$2.75</b>
3/8"	5/8"-18	3/4"	<b>41FL-6</b>	<b>6.85</b>
1/2"	3/4"-16	7/8"	<b>41FL-8</b>	<b>8.55</b>



## Flareless Bite Fittings

**Applications:**

- chemical, pulp and paper, oil and gas refineries, military, air compressors and machine tools
- well-suited for a variety of processing and general hydraulic applications

**Features:**

- Ideally suited for use with tubing having medium to extra heavy wall thicknesses.
- 3 piece design, with only one ferrule eliminates possible make-up errors that may occur using a twin ferrule tube fitting.
- Minimal risk of improper assembly as the ferrule visibly bites into the tubing, allowing installer to visually inspect the bite quality.
- fittings are suitable for sub-zero through elevated temperature applications
- temperature rating is limited by the material chosen
- pressure ratings are determined by the size (OD) and wall thickness (inches/mm) of the tubing on which they are to be installed

**Specifications:**

- exceeds Military (MIL F18866) and SAE J514 standards

**Assembly Instructions:**

- cut, de-burr and clean tubing
- pre-set ferrule onto tubing
- inspect ferrule bite in tubing by disassembling the fitting and visually inspecting the de-burred end of tube for slight indentation
- finger tighten nut and then further wrench tighten nut another 1/3 to 1/2 turn



**Male Tube x Male NPTF Adapters**

Tube OD	Male NPTF	Steel	
		Part #	Price/E
1/8"	1/8"	<i>FLC2404-02</i>	\$7.85
1/8"	1/4"	<i>FLC2404-02-04</i>	7.75
3/16"	1/8"	<i>FLC2404-03-02</i>	8.40
1/4"	1/8"	<i>FLC2404-04-02</i>	5.75
1/4"	1/4"	<i>FLC2404-04</i>	7.45
1/4"	3/8"	<i>FLC2404-04-06</i>	8.75
1/4"	1/2"	<i>FLC2404-04-08</i>	10.10
5/16"	1/8"	<i>FLC2404-05-02</i>	9.25
5/16"	1/4"	<i>FLC2404-05-04</i>	10.65
3/8"	1/8"	<i>FLC2404-06-02</i>	12.10
3/8"	1/4"	<i>FLC2404-06-04</i>	7.70
3/8"	3/8"	<i>FLC2404-06</i>	9.60
3/8"	1/2"	<i>FLC2404-06-08</i>	9.50
1/2"	1/4"	<i>FLC2404-08-04</i>	11.30
1/2"	3/8"	<i>FLC2404-08-06</i>	10.80
1/2"	1/2"	<i>FLC2404-08</i>	9.45
1/2"	3/4"	<i>FLC2404-08-12</i>	17.10
5/8"	3/8"	<i>FLC2404-10-06</i>	12.85
5/8"	1/2"	<i>FLC2404-10-08</i>	12.50
5/8"	3/4"	<i>FLC2404-10-12</i>	33.50
3/4"	1/2"	<i>FLC2404-12-08</i>	19.50
3/4"	3/4"	<i>FLC2404-12</i>	18.25
3/4"	1"	<i>FLC2404-12-16</i>	34.45
1"	3/4"	<i>FLC2404-16-12</i>	32.75
1"	1"	<i>FLC2404-16</i>	29.95
1"	1-1/4"	<i>FLC2404-16-20</i>	45.80
1-1/4"	3/4"	<i>FLC2404-20-12</i>	169.65
1-1/4"	1-1/4"	<i>FLC2404-20</i>	65.00
1-1/2"	1-1/2"	<i>FLC2404-24</i>	72.95

**Male Tube x Male 37° JIC**



Tube OD	Male 37° JIC	Steel	
		Part #	Price/E
1/4"	1/4"	<i>FLC2402-04-04</i>	\$21.10
3/8"	3/8"	<i>FLC2402-06-06</i>	24.10
1/2"	1/2"	<i>FLC2402-08-08</i>	36.55
3/4"	3/4"	<i>FLC2402-12-12</i>	68.20

Male Tube x Female NPTF Adapters

Tube OD	Female NPTF	Steel	
		Part #	Price/E
1/8"	1/8"	FLC2405-02	\$14.55
1/4"	1/8"	FLC2405-04-02	7.25
1/4"	1/4"	FLC2405-04	7.55
5/16"	1/8"	FLC2405-05-02	11.95
3/8"	1/4"	FLC2405-06-04	9.00
3/8"	3/8"	FLC2405-06	10.20
1/2"	1/4"	FLC2405-08-04	12.95
1/2"	3/8"	FLC2405-08-06	13.05
1/2"	1/2"	FLC2405-08	13.05
5/8"	1/2"	FLC2405-10-08	13.55
3/4"	3/4"	FLC2405-12	21.55
1"	1"	FLC2405-16	32.65
1-1/4"	1 1/4"	FLC2405-20	83.35



Pipe, Welding  
& Tube Fittings

Tube Unions

Tube OD	Steel	
	Part #	Price/E
1/8"	FLC2403-02	\$18.15
3/16"	FLC2403-03	13.25
1/4"	FLC2403-04	9.70
5/16"	FLC2403-05	28.45
3/8"	FLC2403-06	12.50
1/2"	FLC2403-08	16.55
5/8"	FLC2403-10	21.15
3/4"	FLC2403-12	29.85
1"	FLC2403-16	46.40
1-1/4"	FLC2403-20	76.00
1-1/2"	FLC2403-24	159.10



Male Tube x Male NPTF Adapter 90° Elbows

Tube OD	Male NPTF	Steel	
		Part #	Price/E
1/8"	1/8"	FLC2501-02	\$11.45
3/16"	1/8"	FLC2501-03-02	13.15
1/4"	1/8"	FLC2501-04-02	7.60
1/4"	1/4"	FLC2501-04	10.60
1/4"	3/8"	FLC2501-04-06	13.50
5/16"	1/8"	FLC2501-05-02	17.85
5/16"	1/4"	FLC2501-05-04	11.65
3/8"	1/8"	FLC2501-06-02	15.65
3/8"	1/4"	FLC2501-06-04	10.25
3/8"	3/8"	FLC2501-06	14.05
3/8"	1/2"	FLC2501-06-08	17.25
1/2"	1/4"	FLC2501-08-04	14.30
1/2"	3/8"	FLC2501-08-06	14.50
1/2"	1/2"	FLC2501-08	20.70
1/2"	3/4"	FLC2501-08-12	44.00
5/8"	3/8"	FLC2501-10-06	27.15
5/8"	1/2"	FLC2501-10-08	18.80
3/4"	1/2"	FLC2501-12-08	54.50
3/4"	3/4"	FLC2501-12	27.00
1"	3/4"	FLC2501-16-12	48.35
1"	1"	FLC2501-16	43.60
1 1/4"	1 1/4"	FLC2501-20	84.00
1 1/2"	1 1/2"	FLC2501-24	128.65





## Male Union 90° Elbows

Tube OD	Steel	
	Part #	Price/E
1/4"	FLC2500-04	\$10.80
5/16"	FLC2500-05	22.95
3/8"	FLC2500-06	13.70
1/2"	FLC2500-08	17.70
5/8"	FLC2500-10	25.20
3/4"	FLC2500-12	36.35
1"	FLC2500-16	59.45
1-1/4"	FLC2500-20	201.10

## Male Tube Union Tees



Tube OD	Steel	
	Part #	Price/E
1/8"	FLC2603-02	\$16.55
3/16"	FLC2603-03	31.65
1/4"	FLC2603-04	20.40
5/16"	FLC2603-05	26.55
3/8"	FLC2603-06	22.05
1/2"	FLC2603-08	30.15
5/8"	FLC2603-10	44.70
3/4"	FLC2603-12	55.00
1"	FLC2603-16	87.65
1-1/4"	FLC2603-20	240.95

## Ferrules



Tube OD	Steel	
	Part #	Price/E
1/8"	FLC0319-02	\$2.35
3/16"	FLC0319-03	3.65
1/4"	FLC0319-04	1.80
5/16"	FLC0319-05	5.75
3/8"	FLC0319-06	2.10
1/2"	FLC0319-08	2.70
5/8"	FLC0319-10	3.55
3/4"	FLC0319-12	4.90
1"	FLC0319-16	7.75
1-1/4"	FLC0319-20	18.15
1-1/2"	FLC0319-24	25.85

## Nuts



Tube OD	Steel	
	Part #	Price/E
1/8"	FLC0318-02	\$2.05
3/16"	FLC0318-03	1.55
1/4"	FLC0318-04	1.75
5/16"	FLC0318-05	3.15
3/8"	FLC0318-06	1.45
1/2"	FLC0318-08	2.25
5/8"	FLC0318-10	3.75
3/4"	FLC0318-12	4.95
1"	FLC0318-16	9.15
1-1/4"	FLC0318-20	14.60
1-1/2"	FLC0318-24	22.85

## Sharkbite® Push to Connect Fittings

**Applications:**

- for **water, dry, clean air** or **100% glycol solutions** only
- connects copper, CPVC, and PEX pipe in any combination
- approved for use underground and behind walls without access panels



**Features:**

- no soldering, clamps, unions or glue needed
- pressure rating: **200 PSI at 200°F (93°C)**
- integral tube liner for PEX installations
- Fittings can be rotated after assembly for easier installation in tight spaces.
- easy to disconnect if needed
- design certified and listed to ASSE 1061/NSF 61
- listed by IAPMO
- meets UPC, IPC and cUPC requirements
- all Sharkbite® fittings are lead free

Pipe, Welding & Tube Fittings

### Straight Couplings

Tube Size	Forged Brass	
	Part #	Price/E
1/2" x 1/2"	<b>U008</b>	<b>\$19.10</b>
3/4" x 3/4"	<b>U016</b>	<b>22.75</b>
1" x 1"	<b>U020</b>	<b>48.00</b>



### Reducing Couplings

Tube Size	Forged Brass	
	Part #	Price/E
3/4" x 1/2"	<b>U058</b>	<b>\$22.75</b>
1" x 3/4"	<b>U060</b>	<b>52.50</b>



### Straight Connectors

Tube Size	Female NPT	Forged Brass	
		Part #	Price/E
1/2"	1/2"	<b>U072</b>	<b>\$15.25</b>
3/4"	3/4"	<b>U088</b>	<b>18.20</b>
1"	1"	<b>U094</b>	<b>38.25</b>



Tube Size	Male NPT	Forged Brass	
		Part #	Price/E
1/2"	1/2"	<b>U120</b>	<b>\$15.25</b>
3/4"	3/4"	<b>U134</b>	<b>18.20</b>
1"	1"	<b>U140</b>	<b>38.25</b>



### Reducing Connectors

Tube Size	Female NPT	Forged Brass	
		Part #	Price/E
1/2"	3/4"	<b>U068</b>	<b>\$18.20</b>



Tube Size	Male NPT	Forged Brass	
		Part #	Price/E
1/2"	3/4"	<b>U116</b>	<b>\$18.20</b>



Sharkbite® Push to Connect Fittings

Elbows



Tube Size	Forged Brass	
	Part #	Price/E
1/2" x 1/2"	<b>U248</b>	<b>\$21.00</b>
3/4" x 3/4"	<b>U256</b>	<b>25.50</b>
1" x 1"	<b>U260</b>	<b>52.50</b>

Drop Ear Elbow



Tube Size	Female NPT	Forged Brass	
		Part #	Price/E
1/2"	1/2"	<b>U334</b>	<b>\$21.00</b>

Tees



Tube Size	Forged Brass	
	Part #	Price/E
1/2"	<b>U362</b>	<b>\$29.00</b>
3/4"	<b>U370</b>	<b>34.50</b>

Reducing Tee



Tube Size (2)	Tube Size	Forged Brass	
		Part #	Price/E
3/4"	1/2"	<b>U412</b>	<b>\$34.50</b>

End Stops



Tube Size	Forged Brass	
	Part #	Price/E
1/2"	<b>U514</b>	<b>\$17.25</b>
3/4"	<b>U518</b>	<b>21.00</b>
1"	<b>U520</b>	<b>43.25</b>

Slip Couplings

Application:

- for use with copper pipe only



Tube Size	Forged Brass	
	Part #	Price/E
1/2"	<b>U3008</b>	<b>\$38.25</b>
3/4"	<b>U3016</b>	<b>45.50</b>

Disconnect Clips



Size	ABS Plastic	
	Part #	Price/E
1/2"	<b>U710</b>	<b>\$4.50</b>
3/4"	<b>U712</b>	<b>4.50</b>
1"	<b>U714</b>	<b>4.85</b>





**LIQUIfit™** Fittings

**Application:**

- Suitable for water, potable liquids and neutral gas applications: including water filtration, water coolers, coffee machines and beverage dispensers.

**Features:**

- EPDM seal secures connection with larger surface area than standard O-rings
- engineered polymer allows superior mechanical strength and chemical resistance
- full stainless gripping ring eliminates the need for locking clips
- release button protects and supports tubing
- FDA compliant
- meets California and Vermont <0.25% lead requirements
- NSF-51 listed for contact with food
- NSF-61 list C-Hot rated
- in compliance with the following standards:   

**Specifications:**

- working pressure:
  - 1/4" **230 PSI** from 35°F to 100°F (1.7°C to 38°C)  
**150 PSI** at 150°F (66°C)  
**60 PSI** at 200°F (93°C)
  - 3/8" **190 PSI** from 35°F to 100°F (1.7°C to 38°C)  
**100 PSI** at 150°F (66°C)  
**60 PSI** at 200°F (93°C)
  - 1/2" **160 PSI** from 35°F to 100°F (1.7°C to 38°C)  
**100 PSI** at 150°F (66°C)  
**60 PSI** at 200°F (93°C)
- maximum torque values for NPTF threads:
  - 1/8" and 1/4" 1.0 ft. lbs. / 1.5Nm
  - 3/8" and 1/2" 2.2 ft. lbs. / 3.0Nm

**Male Connectors**

Tube OD	Male NPTF	Nylon		Pkg Qty
		Part #	Price/E	
1/4"	1/8"	<b>65055611WP2</b>	<b>\$2.55</b>	10
	1/4"	<b>65055614WP2</b>	<b>3.15</b>	10
3/8"	1/4"	<b>65056014WP2</b>	<b>4.25</b>	10
	3/8"	<b>65056018WP2</b>	<b>4.85</b>	10
1/2"	3/8"	<b>65056218WP2</b>	<b>6.70</b>	5
	1/2"	<b>65056222WP2</b>	<b>7.40</b>	5



**Female Connectors**

Tube OD	Female NPTF	Nylon		Pkg Qty
		Part #	Price/E	
1/4"	1/4"	<b>63155614WP2</b>	<b>\$6.00</b>	10
3/8"	3/8"	<b>63156018WP2</b>	<b>6.90</b>	10



**Faucet Connectors**

Tube OD	Female UNS	Nylon		Pkg Qty
		Part #	Price/E	
1/4"	7/16-24	<b>632556133WP2</b>	<b>\$4.90</b>	10
3/8"	7/16-24	<b>632560133WP2</b>	<b>5.50</b>	10



**Fixed Elbows**

Tube OD	Male NPTF	Nylon		Pkg Qty
		Part #	Price/E	
1/4"	1/8"	<b>65795611WP2</b>	<b>\$3.90</b>	10
	1/4"	<b>65795614WP2</b>	<b>4.60</b>	10
	3/8"	<b>65795618WP2</b>	<b>5.20</b>	10
3/8"	1/4"	<b>65796014WP2</b>	<b>5.75</b>	10
	3/8"	<b>65796018WP2</b>	<b>5.90</b>	10



**LIQUIfit™** Fittings

**Union Elbows**



Tube OD	Nylon		Pkg Qty
	Part #	Price/E	
1/4"	<b>63025600WP2</b>	<b>\$4.30</b>	10
3/8"	<b>63026000WP2</b>	<b>6.30</b>	10
1/2"	<b>63026200WP2</b>	<b>8.30</b>	5

**Union Tees**



Tube OD	Nylon		Pkg Qty
	Part #	Price/E	
1/4"	<b>63045600WP2</b>	<b>\$5.60</b>	10
3/8"	<b>63046000WP2</b>	<b>7.35</b>	10
1/2"	<b>63046200WP2</b>	<b>8.85</b>	5

**Union Connectors**



Tube OD 1	Tube OD 2	Nylon		Pkg Qty
		Part #	Price/E	
1/4"	1/4"	<b>63065600WP2</b>	<b>\$3.70</b>	10
	3/8"	<b>63065660WP2</b>	<b>5.50</b>	10
3/8"	3/8"	<b>63066000WP2</b>	<b>5.05</b>	10
	1/2"	<b>63066062WP2</b>	<b>7.30</b>	5
1/2"	1/2"	<b>63066200WP2</b>	<b>6.05</b>	5

**Unequal Union Tee**



Branch Tube OD (1)	Run Tube OD (2)	Nylon		Pkg Qty
		Part #	Price/E	
1/4"	3/8"	<b>63046056WP2</b>	<b>\$8.25</b>	10

**Bulkhead Unions**



Tube OD	Nylon		Pkg Qty
	Part #	Price/E	
1/4"	<b>63165600WP2</b>	<b>\$7.10</b>	10
3/8"	<b>63166000WP2</b>	<b>9.55</b>	10
1/2"	<b>63166200WP2</b>	<b>12.60</b>	5

**Union Y Connectors**



Tube OD	Nylon		Pkg Qty
	Part #	Price/E	
1/4"	<b>63405600WP2</b>	<b>\$6.15</b>	10
3/8"	<b>63406000WP2</b>	<b>7.15</b>	10
1/2"	<b>63406200WP2</b>	<b>11.95</b>	5

**LIQUIfit™** Fittings

**Swivel Elbows**

Tube OD	Male NPTF	Nylon		Pkg Qty
		Part #	Price/E	
1/4"	1/8"	65095611WP2	\$6.30	10
	1/4"	65095614WP2	6.30	10
	3/8"	65095618WP2	6.80	10
3/8"	1/4"	65096014WP2	8.65	10
	3/8"	65096018WP2	9.55	10
1/2"	3/8"	65096218WP2	12.35	4
	1/2"	65096222WP2	12.10	4



Pipe, Welding  
& Tube Fittings

**Swivel Branch Tees**

Tube OD	Male NPTF	Nylon		Pkg Qty
		Part #	Price/E	
1/4"	1/8"	65085611WP2	\$7.45	10
	1/4"	65085614WP2	7.45	10
	3/8"	65085618WP2	7.95	10
3/8"	1/4"	65086014WP2	9.50	10
	3/8"	65086018WP2	9.95	10



**Swivel Male Run Tees**

Tube OD	Male NPTF	Nylon		Pkg Qty
		Part #	Price/E	
1/4"	1/8"	65035611WP2	\$7.45	10
	1/4"	65035614WP2	7.45	10
	3/8"	65035618WP2	7.95	10
3/8"	1/4"	65036014WP2	9.50	10
	3/8"	65036018WP2	9.65	10



**Stem Adapters**

Tube OD	Male NPTF	Nylon		Pkg Qty
		Part #	Price/E	
1/4"	1/4"	65215614WP2	\$1.50	10
	3/8"	65215618WP2	2.05	10
3/8"	1/4"	65216014WP2	1.75	10
	3/8"	65216018WP2	2.20	10
1/2"	3/8"	65216218WP2	3.35	5
	1/2"	65216222WP2	3.35	5



**End Stops**

Tube OD	Nylon		Pkg Qty
	Part #	Price/E	
1/4"	63515600WP2	\$2.80	10
3/8"	63516000WP2	3.25	10



**Plugs**

Tube OD	Nylon		Pkg Qty
	Part #	Price/E	
1/4"	63265600WP2	\$1.15	10
3/8"	63266000WP2	1.75	10
1/2"	63266200WP2	2.58	5



**LIQUIfit™** Fittings

**Hose Stems**



Tube OD	Stem	Nylon		Pkg Qty
		Part #	Price/E	
1/4"	1/4"	<b>63225656WP2</b>	<b>\$2.35</b>	10
3/8"	1/4"	<b>63226056WP2</b>	<b>3.20</b>	10
	5/16"	<b>63226008WP2</b>	<b>3.50</b>	10
	3/8"	<b>63226060WP2</b>	<b>3.70</b>	10
1/2"	3/8"	<b>63226260WP2</b>	<b>4.00</b>	10

**Plug-in Reducers**



Tube OD	Plug-in	Nylon		Pkg Qty
		Part #	Price/E	
1/4"	5/16"	<b>63665608WP2</b>	<b>\$3.90</b>	10
1/4"	3/8"	<b>63665660WP2</b>	<b>4.30</b>	10
3/8"	1/2"	<b>63666062WP2</b>	<b>7.60</b>	5

**Plug-in Elbows**



Tube OD	Plug-in	Nylon		Pkg Qty
		Part #	Price/E	
1/4"	1/4"	<b>63825600WP2</b>	<b>\$3.80</b>	10
3/8"	3/8"	<b>63826000WP2</b>	<b>6.40</b>	10
1/2"	1/2"	<b>63826200WP2</b>	<b>7.60</b>	5

**Plug-in Tees**



Tube OD	Plug-in	Nylon		Pkg Qty
		Part #	Price/E	
1/4"	1/4"	<b>63885600WP2</b>	<b>\$5.60</b>	10
3/8"	3/8"	<b>63886000WP2</b>	<b>8.85</b>	10
1/2"	1/2"	<b>63886200WP2</b>	<b>10.85</b>	5

## TrueSeal™ Ball Valves

### Application:

These corrosion resistant, all-plastic designed ball valves are ideal for water filtration units, coffee and beverage machines and a wide variety of other fluid applications.

### Features:

- EPDM seal secures connection with larger surface area than standard O-rings
- full flow self-cleaning ball
- high-temperature, scale resistant Polysulfone ball
- glass-reinforced Polypropylene body
- FDA compliant
- NSF-51 listed for contact with food
- certified to NSF-61

### Specifications:

- temperature range: **0°F to 225°F (-18°C to 107°C)**
- O-ring seal material: EPDM
- maximum operating pressure: **150 PSI**
- Burst pressure **600 PSI**
- Actual working pressures will be lower at elevated temperatures.

### Tube to Male NPTF

Tube OD	Male NPTF	Polypropylene		Pkg Qty
		Part #	Price/E	
1/4"	1/4"	<b>PP4VMC4-MG</b>	<b>\$13.75</b>	10
	3/8"	<b>PP4VMC6-MG</b>	<b>17.60</b>	10
3/8"	1/4"	<b>PP6VMC4-MG</b>	<b>14.15</b>	10
	3/8"	<b>PP6VMC6-MG</b>	<b>14.20</b>	10



### Tube to Female NPTF

Tube OD	Female NPTF	Polypropylene		Pkg Qty
		Part #	Price/E	
1/4"	1/8"	<b>PP4VFC2-MG</b>	<b>\$17.45</b>	10
	1/4"	<b>PP4VFC4-MG</b>	<b>16.75</b>	10
	3/8"	<b>PP4VFC6-MG</b>	<b>16.75</b>	10
3/8"	1/8"	<b>PP6VFC2-MG</b>	<b>18.05</b>	10
	1/4"	<b>PP6VFC4-MG</b>	<b>17.35</b>	10
	3/8"	<b>PP6VFC6-MG</b>	<b>17.35</b>	10



### Tube to Male NPTF Elbows

Tube OD	Male NPTF	Polypropylene		Pkg Qty
		Part #	Price/E	
1/4"	1/4"	<b>PP4VME4-MG</b>	<b>\$14.55</b>	10
	3/8"	<b>PP4VME6-MG</b>	<b>19.00</b>	10
	1/2"	<b>PP4VME8-MG</b>	<b>23.20</b>	10
3/8"	1/4"	<b>PP6VME4-MG</b>	<b>14.25</b>	10
	3/8"	<b>PP6VME6-MG</b>	<b>17.15</b>	10
	1/2"	<b>PP6VME8-MG</b>	<b>24.05</b>	10



### Tube to Female NPTF Elbows

Tube OD	Female NPTF	Polypropylene		Pkg Qty
		Part #	Price/E	
1/4"	1/4"	<b>PP4VFE4-MG</b>	<b>\$14.90</b>	10
	3/8"	<b>PP4VFE6-MG</b>	<b>17.15</b>	10
3/8"	1/4"	<b>PP6VFE4-MG</b>	<b>15.85</b>	10
	3/8"	<b>PP6VFE6-MG</b>	<b>14.25</b>	10



## TrueSeal™ Ball Valves



## Tube to Tube Unions

Tube OD 1	Tube OD 2	Polypropylene		Pkg Qty
		Part #	Price/E	
1/4"	1/4"	<b>PP4VUC4-MG</b>	<b>\$13.15</b>	10
3/8"	1/4"	<b>PP4VUC6-MG</b>	<b>16.45</b>	10
3/8"	3/8"	<b>PP6VUC6-MG</b>	<b>14.70</b>	10

## Tube to Tube Elbow Unions



Tube OD 1	Tube OD 2	Polypropylene		Pkg Qty
		Part #	Price/E	
1/4"	1/4"	<b>PP4VEU4-MG</b>	<b>\$21.10</b>	10
	3/8"	<b>PP4VEU6-MG</b>	<b>20.35</b>	10
3/8"	1/4"	<b>PP6VEU4-MG</b>	<b>19.60</b>	10
	3/8"	<b>PP6VEU6-MG</b>	<b>18.65</b>	10

## Tube to Plug-in Elbow Unions



Tube OD	Stem	Polypropylene		Pkg Qty
		Part #	Price/E	
1/4"	3/8"	<b>PP4VTEU6-MG</b>	<b>\$18.65</b>	10
3/8"	3/8"	<b>PP6VTEU6-MG</b>	<b>21.45</b>	10

## TrueSeal™ Check Valves

**Application:**

Push-to connect check valves ensure protection against reversal of flow. The valves have an arrow molded into the body to indicate the direction of flow. Valves are designed for connection with either thermoplastic or soft metal tubing and are intended *for use with liquids only*. 

**Features:**

- body material: acetal
- O-ring: EPDM
- metal grip edge: 300 stainless steel
- NSF-51 listed
- maximum operating pressure: **150 PSI** (dependent on tubing used)
- temperature range: **34°F to 150°F (1°C to 65°C)**
- cracking pressure: 1/3 PSI



## Tube to Tube Unions

Tube OD	Acetal		Pkg Qty
	Part #	Price/E	
1/4"	<b>A4VC4-MG</b>	<b>\$23.00</b>	25
3/8"	<b>A6VC6-MG</b>	<b>26.95</b>	25



Double Female Hex Adapters

**Feature:**

- other configurations are available, consult Dixon® for information

Female Thread	Female NST (NH) Thread	Cast Brass	
		Part #	Price/E
1½" NPT	1½"	<b>FFH1515F</b>	<b>\$26.20</b>
2½" NPT	2½"	<b>FFH2525F</b>	<b>59.75</b>
1½" NST (NH)	1½"	<b>FFH15F15F</b>	<b>26.20</b>
2½" NST (NH)	2½"	<b>FFH25F25F</b>	<b>59.75</b>

Female Thread	Female NYFD	Cast Brass	
		Part #	Price/E
1½" NYFD	1½"	<b>FFH15NYFD15NYFD</b>	<b>\$87.45</b>
1½" NPT	1½"	<b>FFH1515NYFD</b>	<b>87.45</b>
2½" NPT	2½"	<b>FFH2525NYFD</b>	<b>120.00</b>

Female Thread	Female Thread	Cast Brass	
		Part #	Price/E
1½" NPT	1½" NPSH	<b>FFH15T15S</b>	<b>\$62.20</b>



Pipe, Welding & Tube Fittings

Female Rocker Lug - Suction with Poly Screen

**Feature:**

- suction intake with strainer screen

Female NST (NH) Thread	Female NPT Thread	Cast Brass	
		Part #	Price/E
2½"	1½"	<b>RSFSA25F15T</b>	<b>\$360.75</b>
	2"	<b>RSFSA25F20T</b>	<b>360.75</b>
	2½"	<b>RSFSA250F</b>	<b>345.50</b>
	3"	<b>RSFSA25F30T</b>	<b>398.55</b>



- All adapters are made to approved Dixon® specifications.
- Replacement washers can be found on page J-99



(Open Snoot) Female Swivel Adapters - Pin Lug

Pipe, Welding  
& Tube Fittings



**Features:**

- double female rigid hexagon to swivel connection, rigid end thread is always NPT, hose thread is on swivel end
- finishes: -P polished, -C polished chrome plated
- other configurations are available, consult Dixon® for information

Female Swivel Thread	Female Rigid Thread	Cast Brass	
		Part #	Price/E
1½" NST (NH)	1½" NPT	<b>SF150F</b>	<b>\$91.70</b>
1½" NPSH	1½" NPT	<b>SF150S</b>	<b>118.20</b>
2½" NST (NH)	1½" NPT	<b>SF25F15T</b>	<b>225.30</b>
2½" NST (NH)	2" NPT	<b>SF25F20T</b>	<b>160.30</b>
2½" NYFD	2½" NPT	<b>SF250NYFD</b>	<b>181.30</b>
2½" NST (NH)	2½" NPT	<b>SF250F</b>	<b>107.60</b>
2½" NST (NH)	2½" NPT	<b>SF250F-P</b>	<b>136.00</b>
2½" NST (NH)	2½" NPT	<b>SF250F-C</b>	<b>145.00</b>
2½" NPSH	2½" NPT	<b>SF250S</b>	<b>181.30</b>
2½" NST (NH)	3" NPT	<b>SF25F30T</b>	<b>167.65</b>
3" NST (NH)	3" NPT	<b>SF300F</b>	<b>292.55</b>
3" NYFD	3" NPT	<b>SF300NYFD</b>	<b>185.40</b>
4" NST (NH)	4" NPT	<b>SF400F</b>	<b>643.20</b>

Domestic Female Swivel Adapters - Pin Lug



**Feature:**

- other configurations are available, consult Dixon® for information

Female NST (NH) Swivel Thread	Female Rigid NPT Thread	Cast Brass	
		Part #	Price/E
1½"	1½"	<b>SF150F-D</b>	<b>\$115.85</b>
2½"	2½"	<b>SF250F-D</b>	<b>178.10</b>
	2"	<b>SF25F20T-D</b>	<b>194.30</b>

(Open Snoot) Female Swivel Adapters - Rocker Lug



**Feature:**

- other configurations are available, consult Dixon® for information

Female NST (NH) Thread	Female Rigid NPT Thread	Cast Brass	
		Part #	Price/E
1½"	1½"	<b>RSF150F</b>	<b>\$91.70</b>
	1½"	<b>RSF25F15T</b>	<b>262.65</b>
	2"	<b>RSF25F20T</b>	<b>160.30</b>
2½"	2½"	<b>RSF250F</b>	<b>149.25</b>
	3"	<b>RSF25F30T</b>	<b>272.60</b>

- All adapters are made to approved Dixon® specifications.
- Replacement washers can be found on page J-99

Double Female Swivels  
Pin Lug

Female NPSH Thread	Female NPSH Thread	Cast Brass	
		Part #	Price/E
1½"	1½"	<b>DFP1515</b>	<b>\$86.25</b>
2½"	2½"	<b>DFP2525</b>	<b>175.10</b>

Female NST (NH) Thread	Female NST (NH) Thread	Cast Brass	
		Part #	Price/E
1½"	1½"	<b>DFP1515F</b>	<b>\$80.90</b>
2½"	2½"	<b>DFP2525F</b>	<b>175.10</b>

Female NST (NH) Thread	Female NPSH Thread	Cast Brass	
		Part #	Price/E
1½"	1½"	<b>DFP15F15S</b>	<b>\$86.25</b>
2½"	2½"	<b>DFP25F25S</b>	<b>175.10</b>

Female NYFD Thread	Female NYFD Thread	Cast Brass	
		Part #	Price/E
1½"	1½"	<b>DFP15NYFD15NYFD</b>	<b>\$147.05</b>
2½"	2½"	<b>DFP25NYFD25NYFD</b>	<b>306.45</b>



Rocker Lug

Female NPSH Thread	Female NPSH Thread	Cast Brass	
		Part #	Price/E
1½"	1½"	<b>DFR1515</b>	<b>\$86.25</b>
2½"	2½"	<b>DFR2525</b>	<b>183.05</b>

Female NST (NH) Thread	Female NST (NH) Thread	Cast Brass	
		Part #	Price/E
1½"	1½"	<b>DFR1515F</b>	<b>\$86.25</b>
2½"	2½"	<b>DFR2525F</b>	<b>183.05</b>



Domestic Double Female Swivels - Pin Lug

Female NST (NH) Thread	Female NST (NH) Thread	Cast Brass	
		Part #	Price/E
1½"	1½"	<b>DFP1515F-D</b>	<b>\$215.00</b>
2½"	2½"	<b>DFP2525F-D</b>	<b>265.00</b>



• Replacement washers can be found on page J-99

Aluminum Swivel Female x Rigid Female Adapters - Rocker Lug Style N53

Pipe, Welding & Tube Fittings



Female NPSH Swivel Thread	Female Rigid NPT Thread	Aluminum Extrusion - Anodized	
		Part #	Price/E
1½"	1½"	<b>N53-15S15T</b>	<b>\$118.10</b>
2"	2"	<b>N53-20S20T</b>	<b>128.90</b>
3"	3"	<b>N53-30S30T</b>	<b>230.90</b>
6"	6"	<b>N53-60S60T</b>	<b>711.00</b>



Female NPSH Swivel Thread	Female Rigid NPSH Thread	Aluminum Extrusion - Anodized	
		Part #	Price/E
1½"	1½"	<b>N53-15S15S</b>	<b>\$100.95</b>



Female NST (NH) Swivel Thread	Female Rigid NPT Thread	Aluminum Extrusion - Anodized	
		Part #	Price/E
1½"	1½"	<b>N53-15F15T</b>	<b>\$100.95</b>
2½"	2"	<b>N53-25F20T</b>	<b>134.15</b>
	2½"	<b>N53-25F25T</b>	<b>136.40</b>
	3"	<b>N53-25F30T</b>	<b>190.05</b>
4"	4"	<b>N53-25F40T</b>	<b>229.50</b>
	4"	<b>N53-40F40T</b>	<b>309.55</b>
4½"	4"	<b>N53-45F40T</b>	<b>331.45</b>
	6"	<b>N53-45F60T</b>	<b>607.70</b>
5"	6"	<b>N53-50F60T</b>	<b>362.40</b>
6"	6"	<b>N53-60F60T</b>	<b>430.15</b>



Female NST (NH) Swivel Thread	Female Rigid NST Thread	Aluminum Extrusion - Anodized	
		Part #	Price/E
1½"	1½"	<b>N53-15F15F</b>	<b>\$143.20</b>
2½"	1½"	<b>N53-25F15F</b>	<b>143.20</b>
	2½"	<b>N53-25F25F</b>	<b>134.15</b>
	6"	<b>N53-25F60F</b>	<b>290.20</b>
4"	4"	<b>N53-40F40F</b>	<b>309.55</b>
6"	4½"	<b>N53-60F45F</b>	<b>438.00</b>

- All adapters are made to approved Dixon® specifications.
- Replacement washers can be found on page J-99

Double Swivel Female Adapters - Rocker Lug  
Style N35

Pipe, Welding  
& Tube Fittings

Female NPSH Swivel Thread	Female NPSH Swivel Thread	Aluminum Extrusion - Anodized	
		Part #	Price/E
1"	1"	<b>N35-10S10S</b>	<b>\$169.00</b>
1½"	1½"	<b>N35-15S15S</b>	<b>140.00</b>
2½"	2½"	<b>N35-25S25S</b>	<b>167.50</b>
3"	3"	<b>N35-30S30S</b>	<b>312.50</b>



Female NST (NH) Swivel Thread	Female NST (NH) Swivel Thread	Aluminum Extrusion - Anodized	
		Part #	Price/E
1"	1"	<b>N35-10F10F</b>	<b>\$169.00</b>
1½"	1½"	<b>N35-15F15F</b>	<b>169.00</b>
	2½"	<b>N35-15F25F</b>	<b>140.00</b>
2½"	2½"	<b>N35-25F25F</b>	<b>136.35</b>
4"	4"	<b>N35-40F40F</b>	<b>410.85</b>
4½"	4½"	<b>N35-45F45F</b>	<b>410.85</b>
5"	5"	<b>N35-50F50F</b>	<b>528.20</b>
6"	6"	<b>N35-60F60F</b>	<b>556.00</b>



Female NPSH Swivel Thread	Female NST Swivel Thread	Aluminum Extrusion - Anodized	
		Part #	Price/E
1"	1"	<b>N35-10S10F</b>	<b>\$169.00</b>
	1½"	<b>N35-10S15F</b>	<b>169.00</b>
1½"	1½"	<b>N35-15S15F</b>	<b>140.00</b>
2"	2½"	<b>N35-20S25F</b>	<b>197.65</b>
2½"	2½"	<b>N35-25S25F</b>	<b>167.50</b>



Aluminum Double Female Swivel Adapters - Long Handle  
Style N57

Female NST (NH) Thread	Male NST (NH) Thread	Aluminum Extrusion - Anodized	
		Part #	Price/E
4½"	6"	<b>N57-45F60F</b>	<b>\$492.55</b>
5"	5"	<b>N57-50F50F</b>	<b>545.45</b>
	6"	<b>N57-50F60F</b>	<b>545.45</b>
6"	6"	<b>N57-60F60F</b>	<b>545.45</b>



- All adapters are made to approved Dixon® specifications.
- Replacement washers can be found on page J-99

Hydrant Adapters - Pin Lug

Feature:

- other configurations are also available, consult Dixon® for information

Female Thread	Male Thread	Cast Brass	
		Part #	Price/E
1½" NPSH	¾" GHT	HA15S76	\$23.70
	¾" NPSH	HA15S75	84.30
	¾" NPT	HA15S75T	84.30
	1" NPSH	HA15S10S	85.85
	1" NPT	HA15S10T	85.85
	1½" NPT	HA15S15T	40.75
	1½" NST (NH)	HA15S15F	40.75
1½" NPT	1½" NPSH	HA15T15S	74.50
	1½" NST (NH)	HA15T15F	40.75
1½" NST (NH)	¾" GHT	HA1576	20.60
	¾" NPSH	HA1575	85.65
	¾" NPT	HA1575T	33.50
	1" NPSH	HA1510	43.25
	1" NST (NH)	HA1510F	40.75
	1" NPT	HA1510T	40.75
	1½" NPSH	HA1515	40.75
	1½" NPT	HA1515T	40.75
	1½" NST (NH)	HA1515F	40.75
2" NPSH	1½" NPSH	HA20S15S	101.35
	1½" NPT	HA20S15T	101.35
	1½" NST (NH)	HA20S15F	36.40
	2½" NST (NH)	HA20S25F	80.10
	2" NPT	HA20T25F	80.10
2" NST (NH)	HA2025F	132.00	
2½" NPSH	1" NPT	HA25S10T	36.40
	1½" NPSH	HA25S15S	115.00
	1½" NPT	HA25S15T	115.00
	1½" NST (NH)	HA25S15F	37.90
	2½" NST (NH)	HA25S25F	72.85
2½" NST (NH)	¾" GHT	HA2576	29.35
	¾" NPT	HA2575T	29.35
	1" NPSH	HA2510	32.35
	1" NST (NH)	HA2510F	32.35
	1" NPT	HA2510T	30.35
	1½" NPSH	HA2515	30.00
	1½" NST (NH)	HA2515F	29.70
	1½" NPT	HA2515T	30.00
	2" NPSH	HA2520	50.95
	2" NST (NH)	HA2520F	50.95
	2" NPT	HA2520T	28.80
	2½" NPSH	HA2525	69.85
	2½" NST (NH)	HA2525F	69.85
	2½" NPT	HA2525T	69.85
3" NPSH	HA2530	108.00	
3" NST (NH)	HA2530F	108.00	
3" NPT	HA2530T	108.00	
3" NPSH	2½" NST (NH)	HA30S25F	82.10
	2½" NPT	HA30S25T	178.10
3" NST (NH)	1½" NPSH	HA3015S	181.00
	1½" NST (NH)	HA3015F	196.20
	2½" NST (NH)	HA3025F	76.40
4" NST (NH)	2½" NST (NH)	HA4025F	145.35
4½" NST (NH)	2½" NST (NH)	HA4525F	218.50



reducer



same size



increaser

- All adapters are made to approved Dixon® specifications.
- Replacement washers can be found on page J-99



Hydrant Adapters - Rocker Lug

Features:

- finishes: -C polished chrome plated
- other configurations are also available, consult Dixon® for information

Pipe, Welding  
& Tube Fittings

Female Thread	Male Thread	Cast Brass	
		Part #	Price/E
1½" NST (NH)	¾" NST (NH)	<b>RHA1576</b>	<b>\$79.90</b>
	1" NST (NH)	<b>RHA1510</b>	<b>46.60</b>
	1" NST (NH)	<b>RHA1510F</b>	<b>46.60</b>
	1" NPT	<b>RHA1510T</b>	<b>46.60</b>
	1½" NPSH	<b>RHA1515</b>	<b>55.80</b>
	1½" NST (NH)	<b>RHA1515F</b>	<b>55.80</b>
	1½" NPT	<b>RHA1515T</b>	<b>55.80</b>
	2" NPSH	<b>RHA1520</b>	<b>113.00</b>
1½" NPSH	2½" NST (NH)	<b>RHA1525F</b>	<b>76.80</b>
	¾" NPT	<b>RHA15S75T</b>	<b>81.85</b>
	1" NPSH	<b>RHA15S10</b>	<b>47.50</b>
	1" NPT	<b>RHA15S10T</b>	<b>49.90</b>
	1½" NST (NH)	<b>RHA15S15F</b>	<b>55.80</b>
1½" NPT	1½" NPT	<b>RHA15S15T</b>	<b>113.00</b>
	1½" NST (NH)	<b>RHA15T15F</b>	<b>55.80</b>
2" NST (NH)	2½" NST (NH)	<b>RHA2025F</b>	<b>132.30</b>
2½" NST (NH)	¾" GHT	<b>RHA2576</b>	<b>36.85</b>
	1" NPSH	<b>RHA2510</b>	<b>49.15</b>
	1" NST (NH)	<b>RHA2510F</b>	<b>49.15</b>
	1" NPT	<b>RHA2510T</b>	<b>49.15</b>
	1½" NPSH	<b>RHA2515</b>	<b>35.50</b>
	1½" NST (NH)	<b>RHA2515F</b>	<b>35.50</b>
	1½" NPT	<b>RHA2515T</b>	<b>75.85</b>
	2" NST (NH)	<b>RHA2520F</b>	<b>144.90</b>
	2" NPT	<b>RHA2520T</b>	<b>51.25</b>
	2½" NPT	<b>RHA2525T</b>	<b>130.00</b>
2½" NPSH	3" NPT	<b>RHA2530T</b>	<b>159.80</b>
	1½" NPSH	<b>RHA25S15</b>	<b>40.25</b>
2½" NPT	1½" NST (NH)	<b>RHA25S15F</b>	<b>40.25</b>
	2½" NST (NH)	<b>RHA25T25F</b>	<b>130.00</b>
3" NST (NH)	2½" NST (NH)	<b>RHA3025F</b>	<b>160.00</b>



reducer



reducer - chrome plated



same size

Female x Male Adapters - Long Handle  
Style N56

Female NST (NH) Thread	Male NST (NH) Thread	Aluminum Extrusion - Anodized	
		Part #	Price/E
4"	2½"	<b>N56-40F25F</b>	<b>\$261.65</b>
4½"	4"	<b>N56-45F40F</b>	<b>315.00</b>
5"	2½"	<b>N56-50F25F</b>	<b>315.00</b>
6"	4½"	<b>N56-60F45F</b>	<b>315.00</b>
	6"	<b>N56-60F60T<sup>1</sup></b>	<b>315.00</b>



<sup>1</sup> female NST (NH) x male NPT

- All adapters are made to approved Dixon® specifications.
- Replacement washers can be found on page J-99

## Hydrant Adapters - Pin Lugs (New York Threads)

Pipe, Welding  
& Tube Fittings



reducer



same size



increaser

**Features:**

- NYFD thread = 3.031 x 8 TPI
- NYC thread = 3.00 x 8 TPI
- other configurations are also available, consult Dixon® for information

Female NYFD Thread	Male Thread	Cast Brass	
		Part #	Price/E
1½"	¾" GHT	<b>HA15NYFD76</b>	<b>\$46.85</b>
	¾" NPT	<b>HA25NYFD75T</b>	<b>107.55</b>
	¾" GHT	<b>HA25NYFD76</b>	<b>34.15</b>
	1½" NPSH	<b>HA25NYFD15S</b>	<b>39.75</b>
	1½" NST (NH)	<b>HA25NYFD15F</b>	<b>39.75</b>
	1½" NPT	<b>HA25NYFD15T</b>	<b>129.15</b>
	1½" NYFD	<b>HA25NYFD15NYFD</b>	<b>39.75</b>
	2" NPT	<b>HA25NYFD20T</b>	<b>35.75</b>
	2½" NST (NH)	<b>HA25NYFD25F</b>	<b>58.90</b>

Female NYC Thread	Male Thread	Cast Brass	
		Part #	Price/E
2½"	¾" GHT	<b>HA25NYC76</b>	<b>\$118.20</b>
	1" NPT	<b>HA25NYC10T</b>	<b>125.85</b>
	1½" NPT	<b>HA25NYC15T</b>	<b>129.15</b>
	2" NPT	<b>HA25NYC20T</b>	<b>35.75</b>

## Hazmat Adapters - Pin Lugs



**Feature:**

- divides single stream into double stream

Female NST Thread	Male Thread	Cast Brass	
		Part #	Price/E
1½"	(2) ¾" GHT	<b>HHA1576</b>	<b>\$47.70</b>
2½"	(2) ¾" GHT	<b>HHA2576</b>	<b>56.45</b>

- All adapters are made to approved Dixon® specifications.
- Replacement washers can be found on page J-99

### Domestic Hydrant Adapters - Pin Lug

**Feature:**

- other configurations are available, consult Dixon® for information

Female NST (NH) Thread	Male Thread	Cast Brass	
		Part #	Price/E
1½"	¾" GHT	<b>HA1576-D</b>	<b>\$68.75</b>
2½"	1" NPT	<b>HA2510T-D</b>	<b>123.00</b>
	1½" NST (NH)	<b>HA2515F-D</b>	<b>109.60</b>
	1½" NPT	<b>HA2515T-D</b>	<b>125.55</b>
	¾" GHT	<b>HA2576-D</b>	<b>135.10</b>



Pipe, Welding & Tube Fittings

### Domestic Female to Male Hex Nipples

**Feature:**

- other configurations are available, consult Dixon® for information

Female Thread	Male Thread	Cast Brass	
		Part #	Price/E
1" NPT	1½" NST (NH)	<b>FM1015F-D</b>	<b>\$71.10</b>
1½" NPT	1½" NST (NH)	<b>FM1515F-D</b>	<b>72.55</b>
	2½" NST (NH)	<b>FM1525F-D</b>	<b>128.00</b>
1½" NST (NH)	1½" NPSH	<b>FM15F15S-D</b>	<b>72.55</b>
	1½" NPT	<b>FM15F15T-D</b>	<b>72.55</b>
	2½" NST (NH)	<b>FM15F25F-D</b>	<b>128.75</b>
1½" NPSH	1½" NST (NH)	<b>FM15S15F-D</b>	<b>72.55</b>
	1½" NPT	<b>FM15S15T-D</b>	<b>72.55</b>
2" NPT	1½" NST (NH)	<b>FM2015F-D</b>	<b>89.25</b>
2½" NPT	2½" NST (NH)	<b>FM2525F-D</b>	<b>126.40</b>
2½" NST (NH)	1½" NST (NH)	<b>FM25F15F-D</b>	<b>128.20</b>
	1½" NPT	<b>FM25F15T-D</b>	<b>128.20</b>
	2½" NPT	<b>FM25F25T-D</b>	<b>126.40</b>



reducer



same size



increaser

### Hydrant Adapters - Rocker Lug

**Features:**

- use with water
- maximum working pressure: **100 PSI at 70°F (21°C)**

Female Thread	Male Thread	Polycarbonate	
		Part #	Price/E
1½" NPSH	1½" NST (NH)	<b>POLYHA15S15F</b>	<b>\$16.35</b>
	¾" GHT	<b>POLYHA2576</b>	<b>19.80</b>
2½" NST (NH)	1½" NPSH	<b>POLYHA2515</b>	<b>23.80</b>
	1½" NST (NH)	<b>POLYHA2515F</b>	<b>23.80</b>
	2" NPT	<b>POLYHA2520T</b>	<b>19.80</b>



- All adapters are made to approved Dixon® specifications.
- Replacement washers can be found on page J-99



polished



polished chrome plated

### Single Male Outlet with Hex (open snoot)

**Application:**

- used to connect fire hose to a standpipe or sprinkler system

**Features:**

- finishes: -P polished, -C polished chrome plated
- other sizes, threads and configurations are available, consult Dixon® for information

Female NPT Thread	Male Thread	Cast Brass	
		Part #	Price/E
2½"	2½" NST (NH)	<b>MOC250F-P</b>	<b>\$149.85</b>
	2½" NST (NH)	<b>MOC250F-C</b>	<b>170.00</b>
3"	2½" NST (NH)	<b>MOC3025F-P</b>	<b>204.55</b>
	2½" NST (NH)	<b>MOC3025F-C</b>	<b>219.70</b>
	3" NST (NH)	<b>MOC300F-P</b>	<b>174.75</b>
Female NPT Thread	Male Thread	Cast Brass	
		Part #	Price/E
2½"	2½" NYC	<b>MOC250NYC-P</b>	<b>\$149.85</b>
	2½" NYFD	<b>MOC250NYFD-P</b>	<b>149.85</b>

### Female to Male Hex Nipples

**Feature:**

- other configurations are also available, consult Dixon® for information

Female Thread	Male Thread	Cast Brass	
		Part #	Price/E
¾" GHT	1" NPT	<b>FM7610T</b>	<b>\$53.35</b>
1" NPSH	¾" GHT	<b>FM10S76</b>	<b>23.40</b>
	¾" GHT	<b>FM1076</b>	<b>20.55</b>
1" NPT	1" NPSH	<b>FM1010</b>	<b>36.60</b>
	1" NST (NH)	<b>FM1010F</b>	<b>33.50</b>
	1½" NPSH	<b>FM1015</b>	<b>69.00</b>
	1½" NST (NH)	<b>FM1015F</b>	<b>41.75</b>
1" NST (NH)	1" NPT	<b>FM10F10T</b>	<b>33.50</b>
1½" NPT	1½" NPSH	<b>FM1515</b>	<b>21.25</b>
	1½" NST (NH)	<b>FM1515F</b>	<b>20.60</b>
	2½" NST (NH)	<b>FM1525F</b>	<b>67.75</b>
1½" NST (NH)	1½" NPSH	<b>FM15F15S</b>	<b>26.05</b>
	1½" NPT	<b>FM15F15T</b>	<b>18.40</b>
	2" NPT	<b>FM15F20T</b>	<b>37.50</b>
	2½" NPT	<b>FM15F25T</b>	<b>64.15</b>
	2½" NST (NH)	<b>FM15F25F</b>	<b>64.15</b>
	1½" NST (NH)	<b>FM15F15F</b>	<b>26.05</b>
1½" NPSH	1½" NST (NH)	<b>FM15S15F</b>	<b>22.85</b>
	1½" NPT	<b>FM15S15T</b>	<b>22.85</b>
	2" NPT	<b>FM15S20T</b>	<b>74.50</b>
2" NPSH	1½" NPSH	<b>FM20S15</b>	<b>64.40</b>
	1½" NST (NH)	<b>FM20S15F</b>	<b>64.40</b>
	1½" NPT	<b>FM20S15T</b>	<b>30.60</b>
	2" NPT	<b>FM20S20T</b>	<b>127.35</b>
	2½" NST (NH)	<b>FM20S25F</b>	<b>91.10</b>
2" NPT	1½" NPSH	<b>FM2015</b>	<b>89.25</b>
	1½" NST (NH)	<b>FM2015F</b>	<b>28.15</b>
	2" NPSH	<b>FM2020</b>	<b>140.00</b>
	2½" NST (NH)	<b>FM2025F</b>	<b>81.40</b>
2½" NST (NH)	¾" NPT	<b>FM25F75T</b>	<b>144.55</b>
	1" NPT	<b>FM25F10T</b>	<b>138.05</b>
	1½" NST (NH)	<b>FM25F15F</b>	<b>80.05</b>
	1½" NPT	<b>FM25F15T</b>	<b>80.05</b>
	2" NPT	<b>FM25F20T</b>	<b>52.05</b>
2½" NPT	1½" NST (NH)	<b>FM2515F</b>	<b>139.00</b>
	2½" NPSH	<b>FM2525</b>	<b>63.15</b>
	2½" NST (NH)	<b>FM2525F</b>	<b>53.75</b>

Table continued on next page

- All adapters are made to approved Dixon® specifications.
- Replacement washers can be found on page J-99



reducer



same size



increaser



Female to Male Hex Nipples

Table continued from previous page

Female Thread	Male Thread	Cast Brass	
		Part #	Price/E
2½" NST (NH)	2½" NST (NH)	<b>FM25F25F</b>	<b>\$62.15</b>
	2½" NPT	<b>FM25F25T</b>	<b>53.80</b>
	3" NST (NH)	<b>FM25F30F</b>	<b>89.80</b>
	3" NPT	<b>FM25F30T</b>	<b>89.80</b>
	2½" NPSH	<b>FM25F25S</b>	<b>144.55</b>
2½" NPT	2½" NPT	<b>FM2525T</b>	<b>102.80</b>
2½" NPSH	2½" NST (NH)	<b>FM25S25F</b>	<b>62.15</b>
	2½" NPT	<b>FM25S25T</b>	<b>62.15</b>
3" NPT	2½" NST (NH)	<b>FM3025F</b>	<b>86.05</b>
	2½" NPT	<b>FM3025T</b>	<b>98.85</b>
	3" NST (NH)	<b>FM3030F</b>	<b>144.65</b>
3" NST (NH)	2½" NST (NH)	<b>FM30F25F</b>	<b>98.85</b>
	2½" NPT	<b>FM30F25T</b>	<b>98.85</b>
	3" NPT	<b>FM30F30T</b>	<b>144.65</b>
3" NPSH	2½" NST (NH)	<b>FM30S25F</b>	<b>201.20</b>
4" NPT	2½" NST (NH)	<b>FM4025F</b>	<b>387.30</b>
	4" NST (NH)	<b>FM4040F</b>	<b>366.40</b>
	4½" NST (NH)	<b>FM4045F</b>	<b>273.55</b>
4" NST (NH)	4" NPT	<b>FM40F40T</b>	<b>287.40</b>
4½" NST (NH)	4" NPT	<b>FM45F40T</b>	<b>454.25</b>
6" NPT	6" NST (NH)	<b>FM6060F</b>	<b>618.00</b>
6" NST (NH)	6" NPT	<b>FM60F60T</b>	<b>618.00</b>

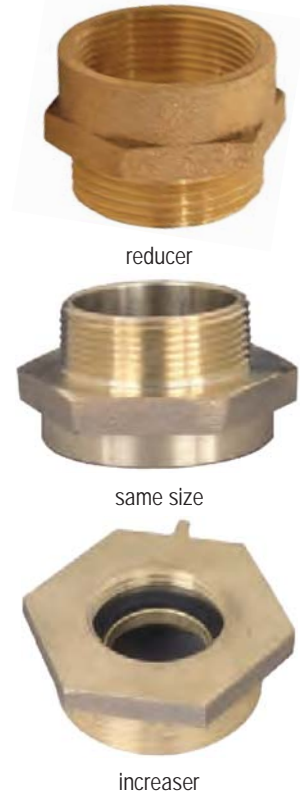

Pipe, Welding & Tube Fittings

Female to Male Hex Nipples (New York Threads)

Features:

- NYFD thread = 3.031 x 8 TPI
- NYC thread = 3.00 x 8 TPI
- other configurations are available, consult Dixon® for information

Female Thread	Male Thread	Cast Brass	
		Part #	Price/E
1½" NPT	1½" NYFD	<b>FM1515NYFD</b>	<b>\$32.00</b>
1½" NST (NH)	1½" NYFD	<b>FM15F15NYFD</b>	<b>32.00</b>
1½" NYFD	1½" NST (NH)	<b>FM15NYFD15F</b>	<b>32.00</b>
	1½" NPT	<b>FM15NYFD15T</b>	<b>32.00</b>

Female Thread	Male Thread	Cast Brass	
		Part #	Price/E
2½" NPT	2½" NYC	<b>FM2525NYC</b>	<b>\$136.00</b>
	2½" NYFD	<b>FM2525NYFD</b>	<b>65.00</b>
2½" NST (NH)	2½" NYC	<b>FM25F25NYC</b>	<b>136.00</b>
	2½" NYFD	<b>FM25F25NYFD</b>	<b>136.00</b>
2½" NYC	2½" NST (NH)	<b>FM25NYC25F</b>	<b>142.05</b>
	2½" NPT	<b>FM25NYC25T</b>	<b>153.15</b>
2½" NYFD	2½" NST (NH)	<b>FM25NYFD25F</b>	<b>67.30</b>
	2½" NPT	<b>FM25NYFD25T</b>	<b>67.30</b>

Female NYFD Thread	Male Thread	Cast Brass	
		Part #	Price/E
2½"	1½" NPT	<b>FM25NYFD15T</b>	<b>\$120.00</b>
	2" NPT	<b>FM25NYFD20T</b>	<b>83.40</b>
	3" NPT	<b>FM25NYFD30T</b>	<b>142.00</b>



- All adapters are made to approved Dixon® specifications.
- Replacement washers can be found on page J-99

Female x Male Adapters - Rocker Lug  
Style N37

Pipe, Welding  
& Tube Fittings



reducer



same size



increaser

Female Thread	Male Thread	Aluminum Extrusion - Anodized	
		Part #	Price/E
3/4" GHT	1" NST (NH)	<b>N37-07G10F</b>	<b>\$75.00</b>
	1" NPSH	<b>N37-07G10S</b>	<b>86.45</b>
	1" NPT	<b>N37-07G10T</b>	<b>75.00</b>
	1 1/2" NST (NH)	<b>N37-07G15F</b>	<b>80.00</b>
	1 1/2" NPSH	<b>N37-07G15S</b>	<b>80.00</b>
1" NST	3/4" GHT	<b>N37-10F07G</b>	<b>75.00</b>
	1" NPSH	<b>N37-10F10S</b>	<b>75.00</b>
	1" NPT	<b>N37-10F10T</b>	<b>75.00</b>
	1 1/2" NST (NH)	<b>N37-10F15F</b>	<b>75.00</b>
	1 1/2" NPSH	<b>N37-10F15S</b>	<b>75.00</b>
	2 1/2" NST (NH)	<b>N37-10F25F</b>	<b>80.00</b>
1" NPSH	3/4" GHT	<b>N37-10S07G</b>	<b>75.00</b>
	3/4" NPSH	<b>N37-10S07S</b>	<b>75.00</b>
	1" NST (NH)	<b>N37-10S10F</b>	<b>75.00</b>
	1" NPT	<b>N37-10S10T</b>	<b>75.00</b>
	1 1/2" NST (NH)	<b>N37-10S15F</b>	<b>75.00</b>
	1 1/2" NPSH	<b>N37-10S15S</b>	<b>75.00</b>
1" NPT	1" NST	<b>N37-10T10F</b>	<b>75.00</b>
1 1/2" NST (NH)	3/4" GHT	<b>N37-15F07G</b>	<b>80.00</b>
	3/4" NPT	<b>N37-15F07T</b>	<b>80.00</b>
	1" NST (NH)	<b>N37-15F10F</b>	<b>80.00</b>
	1" NPSH	<b>N37-15F10S</b>	<b>80.00</b>
	1" NPT	<b>N37-15F10T</b>	<b>80.00</b>
	1 1/2" NST (NH)	<b>N37-15F15F</b>	<b>80.00</b>
	1 1/2" NPSH	<b>N37-15F15S</b>	<b>80.00</b>
	1 1/2" NPT	<b>N37-15F15T</b>	<b>80.00</b>
	2" NPT	<b>N37-15F20T</b>	<b>80.00</b>
	2 1/2" NST (NH)	<b>N37-15F25F</b>	<b>80.00</b>
1 1/2" NPSH	3/4" GHT	<b>N37-15S07G</b>	<b>80.00</b>
	1" NST (NH)	<b>N37-15S10F</b>	<b>127.00</b>
	1 1/2" NST (NH)	<b>N37-15S15F</b>	<b>80.00</b>
	1 1/2" NPT	<b>N37-15S15T</b>	<b>80.00</b>
	2" NPT	<b>N37-15S20T</b>	<b>80.00</b>
1 1/2" NPT	1 1/2" NST (NH)	<b>N37-15T15F</b>	<b>80.00</b>
	1 1/2" NPSH	<b>N37-15T15S</b>	<b>80.00</b>
	2 1/2" NST (NH)	<b>N37-15T25F</b>	<b>80.00</b>
2" NPSH	3/4" GHT	<b>N37-20S07G</b>	<b>90.00</b>
	1 1/2" NST (NH)	<b>N37-20S15F</b>	<b>90.00</b>
	1 1/2" NPSH	<b>N37-20S15S</b>	<b>90.00</b>
	2" NPT	<b>N37-20S20T</b>	<b>90.00</b>
	2 1/2" NST (NH)	<b>N37-20S25F</b>	<b>127.00</b>
2" NPT	1 1/2" NST (NH)	<b>N37-20T15F</b>	<b>90.00</b>
	1 1/2" NPSH	<b>N37-20T15S</b>	<b>90.00</b>
	2 1/2" NST (NH)	<b>N37-20T25F</b>	<b>90.00</b>

• table continued on next page

- All adapters are made to approved Dixon® specifications.
- Replacement washers can be found on page J-99





Female x Male Adapters - Rocker Lug (continued)  
Style N37

Pipe, Welding  
& Tube Fittings

Table continued from previous page

Female Thread	Male Thread	Aluminum Extrusion - Anodized	
		Part #	Price/E
2½" NST (NH)	¾" GHT	<b>N37-25F07G</b>	<b>\$92.50</b>
	¾" NPT	<b>N37-25F07T</b>	<b>92.50</b>
	1" NPT	<b>N37-25F10T</b>	<b>92.50</b>
	1½" NST (NH)	<b>N37-25F15F</b>	<b>92.50</b>
	1½" NPSH	<b>N37-25F15S</b>	<b>92.50</b>
	1½" NPT	<b>N37-25F15T</b>	<b>92.50</b>
	2" NPT	<b>N37-25F20T</b>	<b>92.50</b>
	2½" NST (NH)	<b>N37-25F25F</b>	<b>92.50</b>
	2½" NPSH	<b>N37-25F25S</b>	<b>92.50</b>
	2½" NPT	<b>N37-25F25T</b>	<b>92.50</b>
	3" NST (NH)	<b>N37-25F30F</b>	<b>112.50</b>
	3" NPT	<b>N37-25F30T</b>	<b>112.50</b>
2½" NPSH	1½" NPSH	<b>N37-25S15S</b>	<b>92.50</b>
	2½" NST (NH)	<b>N37-25S25F</b>	<b>92.50</b>
	2½" NPT	<b>N37-25S25T</b>	<b>92.50</b>
2½" NPT	1½" NPSH	<b>N37-25T15S</b>	<b>92.50</b>
	2½" NST (NH)	<b>N37-25T25F</b>	<b>92.50</b>
	3" NPT	<b>N37-25T30T</b>	<b>112.50</b>
3" NST (NH)	1½" NST (NH)	<b>N37-30F15F</b>	<b>218.75</b>
	2½" NST (NH)	<b>N37-30F25F</b>	<b>218.75</b>
	3" NPT	<b>N37-30F30T</b>	<b>218.75</b>
	2½" NST (NH)	<b>N37-30S25F</b>	<b>218.75</b>
3" NPT	2½" NST (NH)	<b>N37-30T25F</b>	<b>218.75</b>
	2½" NPT	<b>N37-30T25T</b>	<b>218.75</b>
4" NST (NH)	2½" NST (NH)	<b>N37-40F25F</b>	<b>212.40</b>
	4" NST (NH)	<b>N37-40F40F</b>	<b>212.40</b>
	4" NPT	<b>N37-40F40T</b>	<b>212.40</b>
	6" NST (NH)	<b>N37-40F60F</b>	<b>212.40</b>
4" NPT	2½" NST (NH)	<b>N37-40T25F</b>	<b>212.40</b>
	4" NST (NH)	<b>N37-40T40F</b>	<b>212.40</b>
	4½" NST (NH)	<b>N37-40T45F</b>	<b>212.40</b>
4½" NST (NH)	2½" NST (NH)	<b>N37-45F25F</b>	<b>254.85</b>
	4" NST (NH)	<b>N37-45F40F</b>	<b>236.70</b>
	4" NPT	<b>N37-45F40T</b>	<b>236.70</b>
	5" NST (NH)	<b>N37-45F50F</b>	<b>236.70</b>
5" NST (NH)	4½" NST (NH)	<b>N37-50F45F</b>	<b>285.50</b>
	5" NPT	<b>N37-50F50T</b>	<b>285.50</b>
	6" NST (NH)	<b>N37-50F60F</b>	<b>285.50</b>
5" NPSH	6" NST (NH)	<b>N37-50S60F</b>	<b>305.00</b>
5" NPT	5" NST (NH)	<b>N37-50T50F</b>	<b>285.50</b>
6" NST (NH)	4" NPT	<b>N37-60F40T</b>	<b>315.00</b>
	5" NST (NH)	<b>N37-60F50F</b>	<b>315.00</b>
	6" NPT	<b>N37-60F60T</b>	<b>290.20</b>
6" NPT	4" NST (NH)	<b>N37-60T40F</b>	<b>270.00</b>
	6" NST (NH)	<b>N37-60T60F</b>	<b>315.00</b>



- All adapters are made to approved Dixon® specifications.
- Replacement washers can be found on page J-99

Brass Female Swivel to Male Adapters

Pin Lug

Pipe, Welding  
& Tube Fittings



Female NST (NH) Thread	Male NPT Thread	Cast Brass	
		Part #	Price/E
1½"	1½"	<b>SM150F</b>	<b>\$74.30</b>
2½"	1½"	<b>SM25F15T</b>	<b>159.40</b>
	2"	<b>SM25F20T</b>	<b>150.40</b>
	2½"	<b>SM250F</b>	<b>94.15</b>
	3"	<b>SM25F30T</b>	<b>179.55</b>
4"	4"	<b>SM400F</b>	<b>574.25</b>

Female NPSH Thread	Male NPT Thread	Cast Brass	
		Part #	Price/E
1½"	1½"	<b>SM150S</b>	<b>\$93.30</b>
2"	2"	<b>SM200S</b>	<b>141.60</b>
2½"	2½"	<b>SM250S</b>	<b>185.40</b>

Female Thread	Male NST (NH) Thread	Cast Brass	
		Part #	Price/E
1½" NPSH	1½"	<b>SM15S15F</b>	<b>\$166.10</b>
2½" NST (NH)	3"	<b>SM25F30F</b>	<b>271.10</b>

Female Thread	Male NPT Thread	Cast Brass	
		Part #	Price/E
1½" NYFD	1½"	<b>SM150NYFD</b>	<b>\$130.85</b>
2½" NYFD	2½"	<b>SM250NYFD</b>	<b>195.00</b>

Rocker Lug



Female Thread	Male NPT Thread	Cast Brass	
		Part #	Price/E
1½" NST (NH)	1½"	<b>RSM150F</b>	<b>\$93.30</b>
1½" NPSH	1½"	<b>RSM150S</b>	<b>90.70</b>
2½" NST (NH)	2"	<b>RSM25F20T</b>	<b>150.40</b>
	2½"	<b>RSM250F</b>	<b>108.15</b>
	3"	<b>RSM25F30T</b>	<b>179.55</b>

Domestic Male Swivel Adapters - Pin Lug



Female NST (NH) Swivel Thread	Male NPT Thread	Cast Brass	
		Part #	Price/E
1½"	1½"	<b>SM150F-D</b>	<b>\$108.35</b>
2½"	2½"	<b>SM250F-D</b>	<b>185.40</b>
	2"	<b>SM25F20T-D</b>	<b>195.75</b>
	3"	<b>SM25F30T-D</b>	<b>350.20</b>

- All adapters are made to approved Dixon® specifications.
- Replacement washers can be found on page J-99

Male Rocker Lug - Suction with Poly Screen

**Feature:**

- suction intake with strainer screen

Female NST (NH) Thread	Male NPT Thread	Cast Brass	
		Part #	Price/E
2½"	2"	<b>RSMSA25F20T</b>	<b>\$337.20</b>
	2½"	<b>RSMSA250F</b>	<b>340.80</b>
	3"	<b>RSMSA25F30T</b>	<b>382.60</b>



Pipe, Welding & Tube Fittings

Male Rocker Lug - Suction with Zinc Screen

**Feature:**

- suction intake with zinc strainer screen - excellent to use before backflow preventers

Female NST (NH) Thread	Male NPT Thread	Cast Brass	
		Part #	Price/E
2½"	2"	<b>RSMSA25F20T-Z</b>	<b>\$374.85</b>
	2½"	<b>RSMSA250F-Z</b>	<b>378.95</b>
	3"	<b>RSMSA25F30T-Z</b>	<b>425.35</b>



Male Rocker Lug - Suction with Poly Screen

**Feature:**

- suction intake with strainer screen

Female NST (NH) Thread	Male NPT Thread	Aluminum	
		Part #	Price/E
2½"	2"	<b>ARSMSA25F20T</b>	<b>\$222.95</b>
	2½"	<b>ARSMSA250F</b>	<b>218.00</b>



- All adapters are made to approved Dixon® specifications.
- Replacement washers can be found on page J-99



Female Swivel to Male Adapters - Rocker Lug  
Style N54

Pipe, Welding  
& Tube Fittings



Female Swivel Thread	Male Rigid Thread	Aluminum Extrusion - Anodized	
		Part #	Price/E
1½" NST (NH)	1½" NST (NH)	<b>N54-15F15F</b>	<b>\$112.45</b>
	1½" NPT	<b>N54-15F15T</b>	<b>145.20</b>
	2½" NST (NH)	<b>N54-15F25F</b>	<b>115.95</b>
1½" NPSH	1½" NPSH	<b>N54-15S15S</b>	<b>121.35</b>
	1½" NPT	<b>N54-15S15T</b>	<b>146.35</b>
2½" NST (NH)	1½" NST (NH)	<b>N54-25F15F</b>	<b>152.35</b>
	1½" NPT	<b>N54-25F15T</b>	<b>155.70</b>
	2" NPT	<b>N54-25F20T</b>	<b>163.40</b>
	2½" NST (NH)	<b>N54-25F25F</b>	<b>123.20</b>
	2½" NPT	<b>N54-25F25T</b>	<b>133.95</b>
	3" NPT	<b>N54-25F30T</b>	<b>137.30</b>
2½" NPSH	2" NPT	<b>N54-25S20T</b>	<b>178.15</b>
3" NPSH	3" NPT	<b>N54-30S30T</b>	<b>214.80</b>
4" NST (NH)	4" NST (NH)	<b>N54-40F40F</b>	<b>228.10</b>
	4" NPT	<b>N54-40F40T</b>	<b>308.85</b>
	6" NST (NH)	<b>N54-40F60F</b>	<b>394.00</b>
4½" NST (NH)	4" NPT	<b>N54-45F40T</b>	<b>321.25</b>
	6" NPT	<b>N54-45F60T</b>	<b>343.00</b>
6" NST (NH)	6" NPT	<b>N54-60F60T</b>	<b>454.60</b>

Female Swivel to Male Adapters - Long Handle  
Style N54L



Female NST Thread	Male Thread	Aluminum Extrusion - Anodized	
		Part #	Price/E
2½"	2½" NST (NH)	<b>N54L-25F25F</b>	<b>\$156.45</b>
4"	6" NST (NH)	<b>N54L-40F60F</b>	<b>475.95</b>
4½"	4" NPT	<b>N54L-45F40T</b>	<b>349.00</b>
6"	4" NPT	<b>N54L-60F40T</b>	<b>443.00</b>
	5" NST (NH)	<b>N54L-60F50F</b>	<b>451.20</b>
	6" NPT	<b>N54L-60F60T</b>	<b>466.80</b>

- All adapters are made to approved Dixon® specifications.
- Replacement washers can be found on page J-99



## Double Male Hex Nipples

**Feature:**

- other configurations are available, consult Dixon® for information

Male Thread	Male Thread	Cast Brass	
		Part #	Price/E
3/4" NPT	1 1/2" NPSH	<b>DMH7515</b>	<b>\$61.25</b>
	1 1/2" NST (NH)	<b>DMH7515F</b>	<b>66.55</b>
1" NPT	3/4" GHT	<b>DMH1076</b>	<b>13.15</b>
	1" NPSH	<b>DMH1010</b>	<b>12.50</b>
	1" NST (NH)	<b>DMH1010F</b>	<b>12.50</b>
	1" NPT	<b>DMH1010T</b>	<b>95.30</b>
	1 1/2" NPSH	<b>DMH1015</b>	<b>69.65</b>
	1 1/2" NST (NH)	<b>DMH1015F</b>	<b>69.65</b>
	2 1/2" NST (NH)	<b>DMH1025F</b>	<b>161.80</b>
1 1/2" NPSH	1 1/2" NPSH	<b>DMH15S15S</b>	<b>81.50</b>
1 1/2" NPT	1" NPSH	<b>DMH1510</b>	<b>75.25</b>
	1" NST (NH)	<b>DMH1510F</b>	<b>75.25</b>
	1 1/2" NPSH	<b>DMH1515</b>	<b>20.70</b>
	1 1/2" NPT	<b>DMH1515T</b>	<b>37.30</b>
	1 1/2" NST (NH)	<b>DMH1515F</b>	<b>18.95</b>
	2" NPSH	<b>DMH1520</b>	<b>61.15</b>
	2 1/2" NST (NH)	<b>DMH1525F</b>	<b>63.00</b>
1 1/2" NST (NH)	1 1/2" NPSH	<b>DMH15F15S</b>	<b>23.15</b>
	1 1/2" NST (NH)	<b>DMH15F15F</b>	<b>23.15</b>
	2 1/2" NST (NH)	<b>DMH15F25F</b>	<b>63.00</b>
2" NPT	1 1/2" NPSH	<b>DMH2015</b>	<b>46.00</b>
	1 1/2" NST (NH)	<b>DMH2015F</b>	<b>39.30</b>
	2" NPSH	<b>DMH2020</b>	<b>43.35</b>
	2 1/2" NPSH	<b>DMH2025</b>	<b>63.25</b>
	2" NPT	<b>DMH2020T</b>	<b>123.05</b>
	2 1/2" NST (NH)	<b>DMH2025F</b>	<b>50.60</b>
2 1/2" NPT	1 1/2" NPSH	<b>DMH2515</b>	<b>168.40</b>
	1 1/2" NST (NH)	<b>DMH2515F</b>	<b>85.25</b>
	2" NPSH	<b>DMH2520</b>	<b>113.00</b>
	2 1/2" NPSH	<b>DMH2525</b>	<b>54.15</b>
	2 1/2" NST (NH)	<b>DMH2525F</b>	<b>53.60</b>
	2 1/2" NPT	<b>DMH2525T</b>	<b>118.20</b>
	3" NPSH	<b>DMH2530</b>	<b>208.95</b>
	3" NPT	<b>DMH2530T</b>	<b>215.00</b>
2 1/2" NST (NH)	3" NST (NH)	<b>DMH2530F</b>	<b>208.95</b>
	2 1/2" NST (NH)	<b>DMH25F25F</b>	<b>52.40</b>
3" NPT	3" NST (NH)	<b>DMH25F30F</b>	<b>215.00</b>
	2 1/2" NPSH	<b>DMH3025</b>	<b>105.00</b>
	2 1/2" NST (NH)	<b>DMH3025F</b>	<b>99.00</b>
	3" NPSH	<b>DMH3030</b>	<b>144.00</b>
	3" NST (NH)	<b>DMH3030F</b>	<b>144.00</b>
4" NPT	3" NPT	<b>DMH3030T</b>	<b>170.25</b>
	4" NPSH	<b>DMH4040</b>	<b>231.00</b>
4" NST (NH)	4" NST	<b>DMH40F40F</b>	<b>313.90</b>
4" NPT	4" NST (NH)	<b>DMH4040F</b>	<b>219.00</b>
	4 1/2" NST (NH)	<b>DMH4045F</b>	<b>235.45</b>
	4" NPT	<b>DMH4040T</b>	<b>332.45</b>
5" NPT	5" NST (NH)	<b>DMH5050F</b>	<b>590.00</b>
6" NPT	4 1/2" NST (NH)	<b>DMH6045F</b>	<b>447.00</b>
	6" NST (NH)	<b>DMH6060F</b>	<b>482.00</b>
	6" NPSH	<b>DMH6060</b>	<b>994.00</b>
	6" NPT	<b>DMH6060T</b>	<b>589.25</b>

Pipe, Welding  
& Tube Fittings



reducer



same size



increaser

- All adapters are made to approved Dixon® specifications.

Double Male Hex Adapters  
(NYFD Threads)



reducer



same size



increaser

**Feature:**

- other configurations are available, consult Dixon® for information

Male Thread	Male NYFD Thread	Cast Brass	
		Part #	Price/E
1½" NPT	1½"	<b>DMH1515NYFD</b>	<b>\$26.15</b>
1½" NST (NH)	1½"	<b>DMH15F15NYFD</b>	<b>57.30</b>
1½" NPT	2½"	<b>DMH1525NYFD</b>	<b>124.10</b>
2" NPT	2½"	<b>DMH2025NYFD</b>	<b>111.20</b>
2½" NPT	1½"	<b>DMH2515NYFD</b>	<b>137.50</b>
2½" NPT	2½"	<b>DMH2525NYFD</b>	<b>53.60</b>

Male NYFD Thread	Male NPT Thread	Cast Brass	
		Part #	Price/E
2½"	2"	<b>DMH2025NYFD</b>	<b>\$111.20</b>

Male NST (NH) Thread	Male NYFD Thread	Cast Brass	
		Part #	Price/E
2½"	2½"	<b>DMH25F25NYFD</b>	<b>\$118.00</b>

Male NYFD Thread	Male NYFD Thread	Cast Brass	
		Part #	Price/E
1½"	1½"	<b>DMH15NYFD15NYFD</b>	<b>\$81.50</b>
2½"	2½"	<b>DMH25NYFD25NYFD</b>	<b>118.00</b>

- NYFD thread: 3.031 x 8 TPI

- All adapters are made to approved Dixon® specifications.



Domestic Double Male Hex Adapters

Feature:

- other configurations are available, consult Dixon® for information

Male Thread	Male Thread	Cast Brass	
		Part #	Price/E
1" NPT	1" NST (NH)	<b>DMH1010F-D</b>	<b>\$54.30</b>
	1½" NST (NH)	<b>DMH1015F-D</b>	<b>69.65</b>
1½" NPT	1½" NPSH	<b>DMH1515-D</b>	<b>74.10</b>
	1½" NST (NH)	<b>DMH1515F-D</b>	<b>74.10</b>
	2½" NST (NH)	<b>DMH1525F-D</b>	<b>134.75</b>
1½" NST (NH)	1½" NST (NH)	<b>DMH15F15F-D</b>	<b>77.35</b>
	1½" NPSH	<b>DMH15F15S-D</b>	<b>78.95</b>
	2½" NST (NH)	<b>DMH15F25F-D</b>	<b>149.85</b>
2" NPT	1½" NST (NH)	<b>DMH2015F-D</b>	<b>59.85</b>
	2" NPSH	<b>DMH2020-D</b>	<b>85.00</b>
	2½" NST (NH)	<b>DMH2025F-D</b>	<b>110.75</b>
2½" NPT	1½" NST (NH)	<b>DMH2515F-D</b>	<b>145.85</b>
	2½" NST (NH)	<b>DMH2525F-D</b>	<b>145.85</b>
2½" NST (NH)	2½" NST (NH)	<b>DMH25F25F-D</b>	<b>145.85</b>
3" NPT	2½" NST (NH)	<b>DMH3025F-D</b>	<b>237.90</b>
	3" NST (NH)	<b>DMH3030F-D</b>	<b>243.20</b>
4" NPT	4½" NST (NH)	<b>DMH4045F-D</b>	<b>435.00</b>
6" NPT	6" NST (NH)	<b>DMH6060F-D</b>	<b>994.00</b>

- All adapters are made to approved Dixon® specifications.



reducer



same size



increaser

Pipe, Welding  
& Tube Fittings

Double Male Adapters

Feature:

- other configurations are available, consult Dixon® for information

Pin Lug

Male Thread	Male Thread	Cast Brass	
		Part #	Price/E
1½" NST (NH)	1½" NST (NH)	<b>DMP1515F</b>	<b>\$88.05</b>
	1½" NPT	<b>DMP15F15T</b>	<b>88.05</b>
1½" NPSH	1½" NPSH	<b>DMP1515</b>	<b>88.05</b>
	1½" NPT	<b>DMP15S15T</b>	<b>88.05</b>
1½" NST (NH)	1½" NPSH	<b>DMP15F15S</b>	<b>88.05</b>
2½" NST (NH)	2½" NST (NH)	<b>DMP2525F</b>	<b>159.60</b>
	2½" NPSH	<b>DMP25F25S</b>	<b>159.60</b>
	2½" NPT	<b>DMP25F25T</b>	<b>159.60</b>
2½" NPSH	2½" NPSH	<b>DMP2525</b>	<b>159.60</b>



Rocker Lug

Male Thread	Male Thread	Cast Brass	
		Part #	Price/E
1½" NST (NH)	1½" NST (NH)	<b>DMR1515F</b>	<b>\$65.40</b>
	1½" NPT	<b>DMR15F15T</b>	<b>65.40</b>
	1½" NPSH	<b>DMR15F15S</b>	<b>65.40</b>
1½" NPSH	1½" NPSH	<b>DMR1515</b>	<b>65.40</b>
	1½" NPT	<b>DMR15S15T</b>	<b>65.40</b>
2½" NST (NH)	2½" NST (NH)	<b>DMR2525F</b>	<b>168.00</b>
2½" NPSH	2½" NPSH	<b>DMR2525</b>	<b>168.00</b>



Double Male Adapters - Rocker Lug  
Style N36

Pipe, Welding  
& Tube Fittings



same size



increaser

Male NST (NH) Thread	Male Thread	Aluminum Extrusion - Anodized	
		Part #	Price/E
1"	1" NST (NH)	<b>N36-10F10F</b>	<b>\$60.95</b>
1½"	1½" NST (NH)	<b>N36-15F15F</b>	<b>60.95</b>
	2" NPT	<b>N36-15F20T</b>	<b>73.35</b>
	2½" NST (NH)	<b>N36-15F25F</b>	<b>73.35</b>
2½"	2½" NST (NH)	<b>N36-25F25F</b>	<b>73.35</b>
	3" NST (NH)	<b>N36-25F30F</b>	<b>105.45</b>
	3" NPT	<b>N36-25F30T</b>	<b>105.45</b>
	4" NST (NH)	<b>N36-25F40F</b>	<b>189.95</b>
	4" NPT	<b>N36-25F40T</b>	<b>189.95</b>
	4½" NST (NH)	<b>N36-25F45F</b>	<b>189.95</b>
3"	3" NST (NH)	<b>N36-30F30F</b>	<b>129.85</b>
4"	4" NST (NH)	<b>N36-40F40F</b>	<b>189.95</b>
4½"	4½" NST (NH)	<b>N36-45F45F</b>	<b>189.95</b>
6"	6" NST (NH)	<b>N36-60F60F</b>	<b>234.55</b>

Male NPT Thread	Male Thread	Aluminum Extrusion - Anodized	
		Part #	Price/E
1½"	1½" NST (NH)	<b>N36-15T15F</b>	<b>\$60.95</b>
	2½" NST (NH)	<b>N36-15T25F</b>	<b>93.75</b>
2"	2" NPT	<b>N36-20T20T</b>	<b>70.15</b>
	2½" NST (NH)	<b>N36-20T25F</b>	<b>103.75</b>
2½"	2½" NST (NH)	<b>N36-25T25F</b>	<b>93.75</b>
	3" NPT	<b>N36-25T30T</b>	<b>93.75</b>
	4" NPT	<b>N36-25T40T</b>	<b>212.85</b>
3"	3" NST (NH)	<b>N36-30T30F</b>	<b>103.75</b>
4"	4" NST (NH)	<b>N36-40T40F</b>	<b>204.35</b>
	4½" NST (NH)	<b>N36-40T45F</b>	<b>204.35</b>
5"	6" NPT	<b>N36-50T60T</b>	<b>277.50</b>
6"	6" NST (NH)	<b>N36-60T60F</b>	<b>277.50</b>

Male NPSH Thread	Male Thread	Aluminum Extrusion - Anodized	
		Part #	Price/E
1"	1" NPSH	<b>N36-10S10S</b>	<b>\$66.20</b>
1½"	1½" NST (NH)	<b>N36-15S15F</b>	<b>66.20</b>
	1½" NPSH	<b>N36-15S15S</b>	<b>66.20</b>
	1½" NPT	<b>N36-15S15T</b>	<b>66.20</b>
	2" NPSH	<b>N36-15S20S</b>	<b>66.20</b>
2½"	2½" NST (NH)	<b>N36-25S25F</b>	<b>86.20</b>
	2½" NPSH	<b>N36-25S25S</b>	<b>86.20</b>

• All adapters are made to approved Dixon® specifications.

## Cam and Groove Hydrant Adapters

**Features:**

- pin lugs allow for easy connection using standard spanner and hydrant wrenches on pages J-113 to J-116
- supplied with a Buna-N washer in the threaded end



Pipe, Welding  
& Tube Fittings

FemaleNST (NH) Thread	Male Adapter	Brass		Aluminum	
		Part #	Price/E	Part #	Price/E
1½"	1½"	<b>HA1515ADP</b>	<b>\$75.50</b>	<b>AHA1515ADP</b>	<b>\$56.05</b>
2½"	2½"	<b>HA2525ADP</b>	<b>83.30</b>	<b>AHA2525ADP</b>	<b>52.50</b>

### Replacement Washers

ID	OD	Thickness	Buna-N	
			Part #	Price/E
1-9/16"	2-1/16"	1/8"	<b>SW150</b>	<b>\$2.00</b>
2-9/16"	3-3/16"	3/16"	<b>SW250</b>	<b>3.25</b>



- All adapters are made to approved Dixon® specifications.



Brass Caps  
Pin Lug

Features:

- finishes: -P polished, -C polished chrome plated
- NOT intended for pressure applications - for debris and thread protection only 



NST (NH) Thread	Cast Brass	
	Part #	Price/E
1½"	<b>FC150F</b>	<b>\$21.40</b>
	<b>FC150F-P</b>	<b>28.15</b>
	<b>FC150F-C</b>	<b>32.50</b>
2"	<b>FC200F</b>	<b>75.50</b>
2½"	<b>FC250F</b>	<b>32.00</b>
	<b>FC250F-P</b>	<b>38.40</b>
	<b>FC250F-C</b>	<b>40.70</b>
3"	<b>FC300F</b>	<b>153.50</b>
4"	<b>FC400F</b>	<b>201.35</b>
4½"	<b>FC450F</b>	<b>201.35</b>
6"	<b>FC600F</b>	<b>308.25</b>

NPSH Thread	Cast Brass	
	Part #	Price/E
1½"	<b>FC150</b>	<b>\$24.45</b>
2"	<b>FC200</b>	<b>55.50</b>
2½"	<b>FC250</b>	<b>43.70</b>
3"	<b>FC300</b>	<b>153.50</b>
4"	<b>FC400</b>	<b>249.40</b>
6"	<b>FC600</b>	<b>308.25</b>

Rocker Lug

Feature:

- finishes: -P polished, -C polished chrome plated



NST (NH) Thread	Cast Brass	
	Part #	Price/E
1"	<b>RFC100F</b>	<b>\$55.20</b>
1½"	<b>RFC150F</b>	<b>25.15</b>
2½"	<b>RFC250F</b>	<b>33.40</b>
	<b>RFC250F-C</b>	<b>68.70</b>

NPSH Thread	Cast Brass	
	Part #	Price/E
¾"	<b>RFC075</b>	<b>\$46.15</b>
1"	<b>RFC100</b>	<b>57.10</b>
1½"	<b>RFC150</b>	<b>28.80</b>
2"	<b>RFC200</b>	<b>85.80</b>
2½"	<b>RFC250</b>	<b>112.30</b>

Brass Test Caps

Features:

- pet cock port supplied with ⅛" NPT
- drain cock port supplied with ¼" NPT



NST (NH) Thread	Brass	
	Part #	Price/E
2½"	<b>NST250TC</b>	<b>\$275.80</b>

## Aluminum Caps with Cable

### Rocker Lug

**Features:**

- other configurations are available, consult Dixon® for information, not all configurations are stocked
- aircraft cable (coated) included

Size	Thread	Extruded Hardcoated Aluminum	
		Part #	Price/E
1"	NST (NH)	<b>CAP100F-C</b>	<b>\$65.80</b>
1½"		<b>CAP150F-C</b>	<b>57.60</b>
2"		<b>CAP200F-C</b>	<b>66.70</b>
2½"		<b>CAP250F-C</b>	<b>84.00</b>
3"		<b>CAP300F-C</b>	<b>146.65</b>
4"		<b>CAP400F-C</b>	<b>262.85</b>
4½"		<b>CAP450F-C</b>	<b>269.70</b>
5"		<b>CAP500F-C</b>	<b>345.85</b>
6"		<b>CAP600F-C</b>	<b>365.85</b>
1"	NPSH	<b>CAP100S-C</b>	<b>65.80</b>
1½"		<b>CAP150S-C</b>	<b>57.60</b>
2"		<b>CAP200S-C</b>	<b>66.70</b>
2½"		<b>CAP250S-C</b>	<b>84.00</b>



### Long Handle

NST (NH) Thread	Extruded Hardcoated Aluminum	
	Part #	Price/E
4"	<b>CAP400F-C-LH</b>	<b>\$313.10</b>
4½"	<b>CAP450F-C-LH</b>	<b>310.00</b>
5"	<b>CAP500F-C-LH</b>	<b>386.75</b>
6"	<b>CAP600F-C-LH</b>	<b>453.65</b>



## Aluminum Test Caps

**Feature:**

- supplied with ¼" NPT drill and tap

Size	Thread	Aluminum	
		Part #	Price/E
1½"	NST (NH)	<b>CAP150FABS</b>	<b>\$64.75</b>
2"		<b>CAP200FABS</b>	<b>137.85</b>
2½"		<b>CAP250FABS</b>	<b>106.10</b>
3"		<b>CAP300FABS</b>	<b>112.25</b>
4"		<b>CAP400FABS</b>	<b>267.05</b>
4½"		<b>CAP450FABS</b>	<b>314.85</b>
5"		<b>CAP500FABS</b>	<b>320.30</b>
6"		<b>CAP600FABS</b>	<b>279.00</b>
1½"	NPSH	<b>CAP150SABS</b>	<b>64.75</b>
2"		<b>CAP200SABS</b>	<b>137.85</b>
2½"		<b>CAP250SABS</b>	<b>106.10</b>
3"		<b>CAP300SABS</b>	<b>112.25</b>
4"		<b>CAP400SABS</b>	<b>267.05</b>
4½"		<b>CAP450SABS</b>	<b>314.85</b>
5"		<b>CAP500SABS</b>	<b>169.05</b>
6"		<b>CAP600SABS</b>	<b>599.50</b>



Thermoplastic Caps

Caps with Chain

Pipe, Welding & Tube Fittings



Application:

- prevents entry of foreign material and protects male outlet threads on valves and hydrants

Feature:

- NOT intended to be pressurized 

Size	Thread	Polycarbonate	
		Part #	Price/E
1½"	NPSH NST (NH)	<b>PFCW150</b>	<b>\$15.10</b>
		<b>PFCW150F</b>	<b>15.10</b>
2"	NPSH	<b>PFCW200</b>	<b>23.20</b>
2½"	NST (NH)	<b>PFCW250F</b>	<b>15.95</b>
3"	NST	<b>PFCW300F</b>	<b>30.30</b>

Pressurizable Caps with Chains



Feature:

- can be pressurized to **300 PSI**

Size	Thread	Polycarbonate	
		Part #	Price/E
2½"	NST (NH) Thread	<b>PFC250F</b>	<b>\$39.40</b>

Hydrant Caps

Features:

- 1½" pentagonal nut with weep hole
- with chain
- gasket not included



NST (NH) Thread	Polycarbonate	
	Part #	Price/E
4½"	<b>PFCW450F-Y</b>	<b>\$45.25</b>

Features:

- 1½" pentagonal nut with weep hole
- gasket not included



NST (NH) Thread	Polycarbonate	
	Part #	Price/E
2½"	<b>PFCW250F-Y</b>	<b>\$12.30</b>
4"	<b>PFCW400F-Y</b>	<b>16.70</b>

Universal Hose Cap

Features:

- universal push on - pull off cap protects all threads by gripping the valve or outlet on the inside of the waterway
- NOT intended to be pressurized 



Size	Polycarbonate	
	Part #	Price/E
2½"	<b>PFC250U</b>	<b>\$19.00</b>



## Breakable Caps

### Polycarbonate

**Application:**

- prevents entry of foreign material and protects female threads on pin lug fire department inlet connections

**Feature:**

- used on pin lug females



Size	Polycarbonate	
	Part #	Price/E
2½"	<b>PBC250</b>	<b>\$8.00</b>

### Aluminum

**Features:**

- for use on fire department inlet connections
- prevents entry of foreign matter and protects female threads
- breakable ears feature permits fast hose connection
- two eyebolts with nuts for attachment to female pin lug swivel
- painted red finish



Size	Aluminum	
	Part #	Price/E
2½"	<b>ABC250</b>	<b>\$10.90</b>

## Specialty Caps

### Domestic Caps - Pin Lug

**Feature:**

- other sizes, threads, and finishes available, call Dixon® for information

Size	Thread	Brass	
		Part #	Price/E
1½"	NST (NH)	<b>FC150F-D</b>	<b>\$67.45</b>
2½"		<b>FC250F-D</b>	<b>88.65</b>



Note: jack chains with S-hooks can be found on page D-52

### Hydrant Caps

**Features:**

- pentagon fire hydrant cap
- supplied with chain and ring

Size	Thread	Iron	
		Part #	Price/E
2½"	NST (NH)	<b>IHC250F</b>	<b>\$56.70</b>
4½"	NST (NH)	<b>IHC450F</b>	<b>84.20</b>



Note: jack chains with S-hooks can be found on page D-52

Specialty Caps

Plugs with Cable - Rocker Lug

Feature:

- NC: no cable option available

Pipe, Welding & Tube Fittings



Size	Extruded Hardcoated Aluminum			
	NST (NH) Part #	Price/E	NPSH Part #	Price/E
1½"	<b>PLUG150F-C</b>	<b>\$67.85</b>	<b>PLUG150S-C</b>	<b>\$67.85</b>
2½"	<b>PLUG250F-C</b>	<b>104.80</b>	<b>PLUG250S-C</b>	<b>104.80</b>
3"	<b>PLUG300F-C</b>	<b>112.95</b>	<b>PLUG300S-C</b>	<b>112.95</b>
4"	<b>PLUG400F-C</b>	<b>148.50</b>	---	---
4½"	<b>PLUG450F-C</b>	<b>241.20</b>	---	---
5"	<b>PLUG500F-C</b>	<b>257.70</b>	---	---
6"	<b>PLUG600F-C</b>	<b>331.30</b>	---	---

Cap Test Gauges

Application:

Used for testing hose or static pressure on hydrants or trucks



Features:

- rocker lug swivel
- petcock to release pressure
- supplied with a 0-300 PSI glycerine 3½" diameter gauge

NST (NH) Thread	Hardcoated Aluminum	
	Part #	Price/E
1½"	<b>AFC150F-TGWP</b>	<b>\$385.15</b>
2½"	<b>AFC250F-TGWP</b>	<b>422.40</b>

FDC Plug

Features:

- fits standard 2½" NST (NH) female swivel
- withstands wide range of temperatures from -4°F to 200°F (-20°C to 93°C)
- 1⅛" pentagonal nut with weep hole to allow for drainage
- removed from FDC with adjustable hydrant wrench



NST (NH) Thread	Polycarbonate	
	Part #	Price/E
2½"	<b>PP250F</b>	<b>\$12.00</b>

Adjust-A-Plug

Features:

- molded red polycarbonate protective plug for swivel connections up to 2½"
- two adjustable metal plates installed in the back of the plug can be mated with your local thread
- plug can be easily removed with a fire department spanner wrench



front



back

Part #	Polycarbonate	
	Price/E	
<b>PAP250</b>	<b>\$8.00</b>	

Brass Plugs  
Pin Lug

Features:

- finishes: -P polished, -C polished chrome plated
- NOT intended for pressure applications - for debris and thread protection only 

NST (NH) Thread	Cast Brass	
	Part #	Price/E
1½"	<b>FP150F</b>	<b>\$40.10</b>
	<b>FP150F-P</b>	<b>50.75</b>
	<b>FP150F-C</b>	<b>53.30</b>
2½"	<b>FP250F</b>	<b>55.40</b>
	<b>FP250F-P</b>	<b>68.60</b>
	<b>FP250F-C</b>	<b>71.25</b>
3"	<b>FP300F</b>	<b>95.10</b>
4"	<b>FP400F</b>	<b>175.10</b>
4½"	<b>FP450F</b>	<b>420.25</b>



NPSH Thread	Cast Brass	
	Part #	Price/E
1½"	<b>FP150</b>	<b>\$40.10</b>
2½"	<b>FP250</b>	<b>55.40</b>

Rocker Lug

Feature:

- finishes: -P polished, -C polished chrome plated

NST (NH) Thread	Cast Brass	
	Part #	Price/E
1½"	<b>RFP150F</b>	<b>\$82.55</b>
2½"	<b>RFP250F</b>	<b>126.35</b>



Domestic Plugs - Pin Lug

NST (NH) Thread	Brass	
	Part #	Price/E
1½"	<b>FP150F-D</b>	<b>\$67.10</b>
2½"	<b>FP250F-D</b>	<b>122.00</b>



Brass Replacement Swivels and Accessories

Pipe, Welding  
& Tube Fittings



**Features:**

- replacement brass swivels for Dixon® fire department connections
- swivel comes with gasket, set screw and ball bearings needed to install on FDC
- other configurations are available, contact Dixon® for information

Size	Female Thread	Brass	
		Part #	Price/E
2½"	NPSH (2.84x8)	<b>PSNP250S</b>	<b>\$103.25</b>
	NST (NH) (3.07x7.5)	<b>PSNP250NST</b>	<b>103.25</b>
	NYC/BA (3.00x8)	<b>PSNP250NYC</b>	<b>103.25</b>
	NYFD (3.03x8)	<b>PSNP250NYFD</b>	<b>103.25</b>
3"	NST (NH)	<b>PSNP300NST</b>	<b>132.10</b>
	NYFD	<b>PSNP300NYFD</b>	<b>132.10</b>

- 2½" requires 50 ball bearings, 3" requires 58 ball bearings

**Replacement Parts**

Description	Part #	Price/E
2½" gasket	<b>SW250</b>	<b>\$3.25</b>
3" gasket	<b>SW300F</b>	<b>6.85</b>
ball bearings	<b>4600300001</b>	<b>0.35</b>
set screw	<b>4601100418</b>	<b>2.15</b>



**Features:**

- for use wherever a non-valved, locking coupling is required
- anodized components per MIL-A-8625 Type III Class 1
- Buna-N gaskets
- working pressure: **150 PSI at 70°F (21°C)**
- cast aluminum lock lever assembly on 4", 5" and 6"

FSA-Storz x Rigid Female

**Storz x NST (NH) Female**

Storz Size	NST (NH) Female Thread	6061-T6 Forged Aluminum	
		Part #	Price/E
1½"	1½"	FSA1515F	\$98.80
2"	1½"	FSA2015F	161.70
	2½"	FSA2025F	137.95
2½"	2½"	FSA2525F	148.50
	3"	FSA3025F	168.75
4"	2½"	FSA4025F	283.75
	3"	FSA4030F	278.10
	4"	FSA4040F	316.00
	4½"	FSA4045F	336.65
	5"	FSA4050F	367.25
	6"	FSA4060F	389.90
5"	2½"	FSA5025F	412.40
	3"	FSA5030F	412.40
	4"	FSA5040F	412.40
	4½"	FSA5045F	430.95
	5"	FSA5050F	441.00
6"	6"	FSA5060F	452.50
	6"	FSA6060F	581.35



**Storz x NPT Female**

Storz Size	NPT Female Thread	6061-T6 Forged Aluminum	
		Part #	Price/E
1½"	1"	FSA1510T	\$98.80
	1½"	FSA1515T	98.80
2"	1½"	FSA2015T	161.70
	2"	FSA2020T	161.70
2½"	1½"	FSA2515T	137.95
	2"	FSA2520T	156.45
	2½"	FSA2525T	148.50
3"	3"	FSA2530T	170.65
	3"	FSA3030T	269.85
4"	3"	FSA4030T	317.80
	4"	FSA4040T	344.95
	6"	FSA4060T	389.90
5"	3"	FSA5030T	412.40
	4"	FSA5040T	412.40
	5"	FSA5050T	441.00
	6"	FSA5060T	452.50
6"	4"	FSA6040T	554.40
	6"	FSA6060T	617.80



**Storz x NPSH Female**

Storz Size	NPSH Female Thread	6061-T6 Forged Aluminum	
		Part #	Price/E
1½"	1½"	FSA1515S	\$98.80
2"	1½"	FSA2015S	161.70
2½"	2½"	FSA2525S	148.50
4"	4"	FSA4040S	344.95



- Replacement washers can be found on page J-112

SFSA - Storz x Swivel Female Adapter - Rocker Lug / Long Handle

**Features:**

- anodized components per MIL-A-8625 Type III Class 1
- Buna-N gaskets
- working pressure: **150 PSI at 70°F (21°C)**
- cast aluminum lock lever assembly on 4", 5" and 6"

**Storz x NST (NH) Female Swivel**

Storz Size	NST (NH) Female Swivel Thread	6061-T6 Forged Alumium	
		Part #	Price/E
2½"	2½"	<b>SFSA2525F</b>	<b>\$194.25</b>
3"	2½"	<b>SFSA3025F</b>	<b>211.95</b>
4"	2½"	<b>SFSA4025F</b>	<b>360.60</b>
	3"	<b>SFSA4030F</b>	<b>407.25</b>
	4"	<b>SFSA4040F</b>	<b>412.65</b>
	4½"	<b>SFSA4045F</b>	<b>458.20</b>
	6"	<b>SFSA4060F</b>	<b>573.35</b>
5"	2½"	<b>SFSA5025F</b>	<b>518.45</b>
	4"	<b>SFSA5040F</b>	<b>526.95</b>
	4½"	<b>SFSA5045F</b>	<b>531.70</b>
6"	6"	<b>SFSA5060F</b>	<b>620.95</b>
	6"	<b>SFSA6060F</b>	<b>664.40</b>



**Storz x NPSH Female**

Storz Size	NPSH Female Swivel Thread	6061-T6 Forged Alumium	
		Part #	Price/E
2½"	2½"	<b>SFSA2525S</b>	<b>\$199.20</b>
3"	3"	<b>SFSA3030S</b>	<b>231.95</b>
4"	4"	<b>SFSA4040S</b>	<b>412.65</b>
5"	6"	<b>SFSA5060S</b>	<b>620.95</b>



**Storz x NST (NH) Female Swivel - Long Handle**

Storz Size	NST (NH) Female Swivel Thread	6061-T6 Forged Alumium	
		Part #	Price/E
4"	4½"	<b>SFSA4045F-LH</b>	<b>\$486.85</b>
5"	4"	<b>SFSA5040F-LH</b>	<b>562.45</b>
5"	4½"	<b>SFSA5045F-LH</b>	<b>543.85</b>
6"	6"	<b>SFSA6060F-LH</b>	<b>681.55</b>



- All adapters are made to approved Dixon® specifications.
- Replacement washers can be found on page J-112



MSA - Storz x Rigid Male

Storz x NST (NH) Male

Storz Size	NST (NH) Male Thread	6061-T6 Forged Alumium	
		Part #	Price/E
1½"	1½"	<b>MSA1515F</b>	<b>\$95.10</b>
2"	1½"	<b>MSA2015F</b>	<b>115.85</b>
2½"	2½"	<b>MSA2525F</b>	<b>166.80</b>
3"	2½"	<b>MSA3025F</b>	<b>191.20</b>
4"	2½"	<b>MSA4025F</b>	<b>261.35</b>
	4"	<b>MSA4040F</b>	<b>287.30</b>
	4½"	<b>MSA4045F</b>	<b>355.80</b>
5"	2½"	<b>MSA5025F</b>	<b>355.80</b>
	5"	<b>MSA5050F</b>	<b>418.10</b>



Pipe, Welding & Tube Fittings

Storz x NPT Male

Storz Size	NPT Male Thread	6061-T6 Forged Alumium	
		Part #	Price/E
1½"	1½"	<b>MSA1515T</b>	<b>\$109.50</b>
2"	1½"	<b>MSA2015T</b>	<b>115.85</b>
2½"	2"	<b>MSA2520T</b>	<b>142.25</b>
	2½"	<b>MSA2525T</b>	<b>166.80</b>
	3"	<b>MSA2530T</b>	<b>191.20</b>
3"	3"	<b>MSA3030T</b>	<b>191.20</b>
4"	4½"	<b>MSA4025T</b>	<b>261.35</b>
	4"	<b>MSA4040T</b>	<b>287.30</b>
5"	4"	<b>MSA5040T</b>	<b>372.70</b>
6"	6"	<b>MSA6060T</b>	<b>500.65</b>



Storz x NPSH Male

Storz Size	NPSH Male Thread	6061-T6 Forged Alumium	
		Part #	Price/E
1½"	1½"	<b>MSA1515S</b>	<b>\$100.60</b>
2"	1½"	<b>MSA2015S</b>	<b>115.85</b>



1½" x 1½"



SFSA30 - Storz x Female Swivel 30° Elbow - Rocker Lug

Pipe, Welding & Tube Fittings



Features:

- anodized components per MIL-A-8625 Type III Class 1
- Buna-N gaskets
- working pressure: **150 PSI at 70°F (21°C)**
- cast aluminum lock lever assembly on 4", 5" and 6"
- screens available for 4" and 5" heads, consult Dixon® for information

Storz Size	NST (NH) Female Swivel Thread	6061-T6 Forged Aluminum	
		Part #	Price/E
4"	4"	<b>SFSA30-4040F</b>	<b>\$412.40</b>
	5"	<b>SFSA30-4050F</b>	<b>704.50</b>
	6"	<b>SFSA30-4060F</b>	<b>725.25</b>
5"	3"	<b>SFSA30-5030F</b>	<b>725.40</b>
	4"	<b>SFSA30-5040F</b>	<b>2617.40</b>
	4½"	<b>SFSA30-5045F</b>	<b>2699.00</b>
	6"	<b>SFSA30-5060F</b>	<b>3046.55</b>

- Replacement washers can be found on page J-112

SFSA30 - Storz x Female Swivel 30° Elbow - Long Handle



Features:

- anodized components per MIL-A-8625 Type III Class 1
- Buna-N gaskets
- working pressure: **150 PSI at 70°F (21°C)**
- cast aluminum lock lever assembly on 4", 5" and 6"

Storz Size	NST (NH) Female Swivel Thread	6061-T6 Forged Aluminum	
		Part #	Price/E
4"	4½"	<b>SFSA30-4045F-LH</b>	<b>\$458.20</b>
	5"	<b>SFSA30-4050F-LH</b>	<b>738.85</b>
	6"	<b>SFSA30-4060F-LH</b>	<b>761.75</b>

- Replacement washers can be found on page J-112

NCS-CSF - 150 lbs. Carbon Steel Flange x Storz



150# Flange	Storz	Carbon Steel	
		Part #	Price/E
4"	5"	<b>NCS-CSF-STZ450</b>	<b>\$559.95</b>
	6"	<b>NCS-CSF-STZ460</b>	<b>735.55</b>
5"	4"	<b>NCS-CSF-STZ540</b>	<b>559.95</b>
	5"	<b>NCS-CSF-STZ550</b>	<b>605.75</b>
	6"	<b>NCS-CSF-STZ560</b>	<b>781.40</b>
6"	4"	<b>NCS-CSF-STZ640</b>	<b>389.95</b>
	5"	<b>NCS-CSF-STZ650</b>	<b>495.00</b>
	6"	<b>NCS-CSF-STZ660</b>	<b>588.90</b>

- For flange dimensions, diagrams and additional information please reference [dixonvalve.com](http://dixonvalve.com).

NCS-CSF - 150 lbs. Carbon Steel Flange x Storz with Cap



150# Flange	Storz	Carbon Steel	
		Part #	Price/E
5"	6"	<b>NCS-CSF-STZ650C</b>	<b>\$709.30</b>
6"	6"	<b>NCS-CSF-STZ660C</b>	<b>931.65</b>

- For flange dimensions, diagrams and additional information please reference [dixonvalve.com](http://dixonvalve.com).

SSA - Storz x Storz Adapter

Features:

- anodized components per MIL-A-8625 Type III Class 1
- Buna-N gaskets
- working pressure: **150 PSI at 70°F (21°C)**
- cast aluminum lock lever assembly on 4", 5" and 6"

Storz Size	Storz Size	6061-T6 Forged Alumium	
		Part #	Price/E
1½"	2"	<b>SSA1520</b>	<b>\$192.65</b>
	2½"	<b>SSA1525</b>	<b>281.10</b>
2"	2½"	<b>SSA2025</b>	<b>238.55</b>
	3"	<b>SSA2030</b>	<b>186.50</b>
	4"	<b>SSA2540</b>	<b>566.95</b>
4"	5"	<b>SSA4050</b>	<b>649.50</b>
	6"	<b>SSA4060</b>	<b>899.60</b>
5"	6"	<b>SSA5060</b>	<b>940.60</b>



Pipe, Welding & Tube Fittings

SSA30 - Storz x Storz 30° Elbow Adapters

Features:

- anodized components per MIL-A-8625 Type III Class 1
- Buna-N gaskets
- working pressure: **150 PSI at 70°F (21°C)**
- cast aluminum lock lever assembly on 4", 5" and 6"

Storz Size	Storz Size	6061-T6 Forged Alumium	
		Part #	Price/E
5"	5"	<b>SSA30-550</b>	<b>\$812.75</b>



Accessories

Pipe, Welding  
& Tube Fittings



Threaded Storz Mounting Plates (Bracket)

Storz Size	Anodized Aluminum	
	Part #	Price/E
1½" - 2½"	<b>SMB1525</b>	<b>\$54.05</b>
4" - 5"	<b>SMB450</b>	<b>77.60</b>

Storz Caps

Features:

- 4", 5", 6" supplied with cables
- 1½", 2", 2½", 3" supplied with chains



Storz Size	Aluminum	
	Part #	Price/E
1½"	<b>SC150-NL</b>	<b>\$111.75</b>
2"	<b>SC200-NL</b>	<b>111.75</b>
2½"	<b>SC250-NL</b>	<b>115.75</b>
3"	<b>SC300-NL</b>	<b>158.85</b>
4"	<b>SC400-NL</b>	<b>178.80</b>
4" ABS	<b>SC400ABS<sup>1</sup></b>	<b>220.50</b>
5"	<b>SC500-NL</b>	<b>214.30</b>
5" ABS	<b>SC500ABS<sup>1</sup></b>	<b>300.00</b>
6"	<b>SC600-NL</b>	<b>342.75</b>

<sup>1</sup> ABS includes airbleeder/petcock

Storz Gaskets

Features:

- gasket faces should be kept free of sand, grit, etc. and lubricated with O-ring grease or silicone 
- pressure seals have a flat face
- suction seals have a beaded face



Storz Size	Buna-N		Buna-N	
	Pressure Part #	Price/E	Suction Part #	Price/E
1½"	<b>SGS150-NL<sup>1</sup></b>	<b>\$15.10</b>	<b>SGS150-NL</b>	<b>\$15.10</b>
2"	<b>SGP200</b>	<b>9.20</b>	<b>SGS200-NL</b>	<b>12.70</b>
2½"	<b>SGP250</b>	<b>9.20</b>	<b>SGS250-NL</b>	<b>19.70</b>
3"	<b>SGP300</b>	<b>9.20</b>	<b>SGS300-NL</b>	<b>20.50</b>
4"	<b>SGP400</b>	<b>13.80</b>	<b>SGS400-NL</b>	<b>47.25</b>
5"	<b>SGP500</b>	<b>21.25</b>	<b>SGS500-NL</b>	<b>53.40</b>
6"	<b>SGS600-NL<sup>1</sup></b>	<b>51.25</b>	<b>SGS600-NL</b>	<b>51.25</b>

<sup>1</sup> gasket can be used for both pressure and suction service

Storz Locking Device



Description	Part #	Price/E
metal locking device used on 4" and 5" Storz heads with spring, screw and washer	<b>LOCKINGDEVICE</b>	<b>\$31.50</b>
metal locking device used on 6" Storz heads with spring, screw and washer	<b>LOCKINGDEVICE6</b>	<b>60.00</b>

### Universal Spanner Wrench

**Features:**

- for ¾" to 3" pin lug and rocker lug couplings
- includes gas cock shutoff, pry bar and belt hook eye
- overall length 11¾"

Part #	Aluminum	Price/E	Pkg Qty
<b>USW</b>		<b>\$24.70</b>	25



Pipe, Welding & Tube Fittings

### Universal Wrench

**Features:**

- for pin lug or rocker lug couplings 1" - 4½"
- a gas cock shutoff is provided in the handle
- red epoxy painted
- overall length 11¾"

Part #	Iron	Price/E
<b>233</b>		<b>\$43.20</b>



### Hole Type Spanner Wrench

**Features:**

- designed for use on ¾" and 1" booster hose couplings
- overall length is 7½"

Part #	AL-MAG 35	Price/E
<b>HTSW</b>		<b>\$15.00</b>



### Storz Hydrant Wrench

**Features:**

- fits 4" and 5" Storz
- ductile iron head
- knurled chrome plated handle
- manganese bronze adjustable jaw
- includes adjustable hydrant nut wrench

Part #	Price/E
<b>SAHW</b>	<b>\$100.00</b>



### Folding Pocket Spanner Wrenches

**Features:**

- for pentagon nuts up to 1¾"
- built-in spanner for pin or rocker lug couplings
- overall length 16¼"

Material	Part #	Price/E
aluminum	<b>PSW</b>	<b>\$43.00</b>
brass	<b>PSW-B</b>	<b>171.10</b>
die cast zinc	<b>PSW-Z</b>	<b>41.35</b>
yellow plastic	<b>PSW-Y</b>	<b>86.65</b>



### Adjustable Hydrant Wrench

**Features:**

- fits ¾" to 3" rocker lug and pin lug couplings
- a compact wrench easily carried in your jacket pocket

Part #	Aluminum	Price/E	Pkg Qty
<b>AHW</b>		<b>\$40.20</b>	20



### Pigtail Adjustable Hydrant Wrench



**Feature:**

- double spanner head fits pin lug or rocker (sensible) lug couplings, pentagon nuts up to 1½" from point to flat, 1½" - 6" rocker lug caps, 2" - 4½" pin lug caps, and square nuts up to 1⅝"

Part #	Price/E
<b>AHWPT</b>	<b>\$69.25</b>

### Heavy Duty Adjustable Hydrant Wrench



**Features:**

- for pentagon hydrant nuts up to 1¾" from point to flat
- notched to fit 1¼" square hydrant nut
- spanner for pin lug and sensible (rocker) lug couplings, 1½" thru 6"
- plated iron head, ⅞" plated steel handle
- overall length 18"

Part #	Price/E	Pkg Qty
<b>189</b>	<b>\$38.70</b>	15

### Double Head Adjustable Hydrant Wrench



**Features:**

- for pentagon hydrant nuts up to 1⅞" and square heads up to 1½"
- fits ¾" - 6" rocker lug or pin lug couplings, can also be used for long handle couplings
- ductile iron head with a deeply knurled chrome plated steel handle
- replaceable adjustable jaw is made of manganese bronze
- overall length 19½"

Part #	Price/E
<b>189DH</b>	<b>\$86.25</b>

### 5 Hole Hydrant Wrench



**Features:**

- 5 pentagon holes designed to fit common hydrant nut sizes
- built-in spanner for pin or rocker lug couplings
- overall length: 14¼"

Part #	Plated Iron	Price/E	Pkg Qty
<b>PHW</b>		<b>\$24.00</b>	25

### Grip-All Spanner Wrench



**Features:**

- fits ¾" - 6" split lug, rocker lug and pin lug couplings
- can be operated in tight quarters
- gas cock shutoff is provided in the handle, handle is shaped to fit your hand allowing a positive grip on the coupling

Part #	Aluminum	Price/E
<b>GAW</b>		<b>\$23.25</b>



## Hydrant Wrenches

**Application:**

- used for hydrant work by water works companies and on construction sites

**Features:**

- overall length 15"
- fits up to 4" pin lug or rocker lug couplings
- complete with pry bar
- 1¼" square hydrant wrench



Part #	A356 Aluminum	Price/E
<b>DF16-180</b>		<b>\$38.00</b>

**Features:**

- fits up to 2½" pin lug or rocker lug couplings
- complete with pry bar and 1¼" nut wrench
- lug / drum wrench



Part #	A356 Aluminum	Price/E
<b>DF16-181</b>		<b>\$37.00</b>

## Long Handle Suction Spanner Wrench

**Features:**

- use on long handle, rocker lug, or pin lug couplings from 2½" - 6"
- open end slips over long handles for additional leverage, the claw fits rocker lugs or pin lugs, the other end can be used as a pry or crowbar
- inverted "T" body construction for lighter weight and improved strength
- can be used on Dixon® cam and groove pin lug or trapezoidal lug tank car adapters or 8" pin lug couplings
- overall length 18¾"



Part #	Plated Iron	Price/E
<b>LHW</b>		<b>\$439.95</b>

## Forestry Hose Clamp and Spanner

**Features:**

- material: cast aluminum and brass
- off-set handle enables the user to easily operate the clamp while wearing gloves
- to be used with lightweight 1" and 1½" hoses for pressures up to 200 PSI
- when clamped onto the hose the brass locking device safely holds the clamp in position, a spanner is an integral part of the clamp
- overall length 10"



Part #	Cast Aluminum	Price/E
<b>FHCS150</b>		<b>\$199.55</b>

## Forestry Pocket Spanner Wrenches

**Features:**

- FSW1: for use on 1" hoses only
- FSW2: for 1" and 1½" hose couplings
- overall length 5"
- meets USFDA specification 5100-101C



Part #	Aluminum	Price/E
<b>FSW1</b>		<b>\$47.25</b>
<b>FSW2</b>		<b>47.25</b>

Storz Wrenches

Pipe, Welding  
& Tube Fittings

Pin Lug Spanner Wrenches - Single End



Size	Plated Iron	
	Part #	Price/E
2"	<b>SW20</b>	<b>\$10.15</b>
2½"	<b>SW25</b>	<b>11.55</b>
3"	<b>SW30</b>	<b>13.25</b>
4"	<b>SW40</b>	<b>13.85</b>
6"	<b>SW60</b>	<b>84.85</b>

Pin Lug Spanner Wrenches - Double End



Size	Plated Iron	
	Part #	Price/E
1½", 2" x 2½", 3"	<b>SW153</b>	<b>\$25.50</b>

Spanner Wrench - Single End



SZW2

- Features:**
- SW1530 fits 1½" - 3" Storz
  - SZW2 for use on 4" and 6" Storz



SW1530

Size	AL-MAG 35	
	Part #	Price/E
1½" - 3"	<b>SW1530</b>	<b>\$66.00</b>
4" - 6"	<b>SZW2</b>	<b>23.23</b>

Spanner Wrenches - Double End



SZW2-NL



SW-S400

Used On	Material	Part #	Price/E
2" - 5"	<i>aluminum</i>	<b>SZW2-NL</b>	<b>\$61.20</b>
2" - 5"	<i>steel</i>	<b>SW-S400</b>	<b>50.00</b>

Holder with (2) Wrenches - Double Ended



Description	Material	Part #	Price/E
2 Storz wrenches (2½" - 5") with bracket	<i>aluminum</i>	<b>SWB-2</b>	<b>\$181.30</b>
2 Storz wrenches (2½" - 5") with bracket	<i>steel</i>	<b>SWB-S-2</b>	<b>175.70</b>
4 Storz wrenches (2½" - 5") with bracket	<i>steel</i>	<b>SWB-S-4</b>	<b>261.60</b>

Long Handle Short Shank Suction Hose Females

Features:

- powder coated aluminum swivel nut
- for suction and low pressure discharge only

Female Swivel NST (NH)	Hose Size	Powder Coated Aluminum	
		Part #	Price/E
4"	4"	<b>LHFS400F</b>	<b>\$140.00</b>
4½"	4"	<b>LHFS4045F</b>	<b>297.25</b>



Pipe, Welding & Tube Fittings

Angle and Suction Elbows

Features:

- for use on pump discharge valves, or suction inlets to minimize hose kinking
- rocker lug swivel
- satin brass finish
- -C polished chrome plated

Male NST (NH) Thread	Female NST (NH) Thread	Angle	Brass	
			Part #	Price/E
2½"	2½"	30°	<b>RSE30250F-C</b>	<b>\$358.10</b>
		45°	<b>RSE45250F</b>	<b>209.10</b>
		45°	<b>RSE45250F-C</b>	<b>298.00</b>
		90°	<b>RSE90250F</b>	<b>216.00</b>
		90°	<b>RSE90250F-C</b>	<b>242.00</b>



30° elbow



45° elbow

Continuous Swivel Elbows

Features:

- allows hose to swing when connected
- full waterway reduces friction loss
- short style radius is 2½" measured from the center of the waterway to the end of the discharge thread

Female NPT Thread	Male Thread	Length	Cast Brass	
			Part #	Price/E
1½"	1½" NST (NH)	2½"	<b>CSES150F</b>	<b>\$180.00</b>
2"	1½" NST (NH)	2½"	<b>CSES2015F</b>	<b>180.00</b>
1½"	1½" NPT	2½"	<b>CSES150T</b>	<b>180.00</b>



Dixon® Angle and Suction Elbows N54

Features:

- ideal for fire apparatus with front suction connections
- anodized, powder coated aluminum, extruded
- anodized female swivel connections

Male NST (NH) Thread	Female NST (NH) Swivel Thread	Angle	Aluminum	
			Part #	Price/E
2½"	2½"	30°	<b>N5430-25F25F</b>	<b>\$318.70</b>
		45°	<b>N5445-25F25F</b>	<b>262.50</b>
		60°	<b>N5460-25F25F</b>	<b>330.90</b>
		90°	<b>N5490-25F25F</b>	<b>332.80</b>



90° elbow

• Replacement washers can be found on page J-99

Pump Test Headers

Pipe, Welding & Tube Fittings



flanged



Features:

- available connections: grooved, flanged and threaded
- certified D1, G1, G6
- other sizes, configurations available, consult Dixon® for information

End Connection	End Size	# of Outlets	Pump Size Max. GPM	Part #	Price/E
150# flanged	3"	1	300	<i>HVF0301-25</i>	<b>\$454.35</b>
	4"	2	500	<i>HVF0402-25</i>	<b>749.15</b>
	6"	3	750	<i>HVF0603-25</i>	<b>1126.80</b>
	6"	4	1000	<i>HVF0604-25</i>	<b>1263.50</b>
	6"	6	1000	<i>HVF0606-25</i>	<b>1537.05</b>
	8"	6	2000	<i>HVF0806-25</i>	<b>1966.25</b>
grooved	6"	3	750	<i>HVG0603-25</i>	<b>808.15</b>
	6"	4	1000	<i>HVG0604-25</i>	<b>945.00</b>
	8"	3	750	<i>HVG0803-25</i>	<b>1008.30</b>
	8"	6	2000	<i>HVG0806-25</i>	<b>1453.80</b>

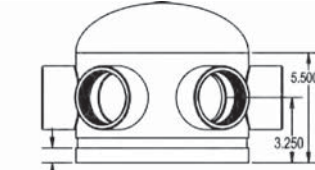

grooved

Manifolds



Model Number Breakdown

T98060-30

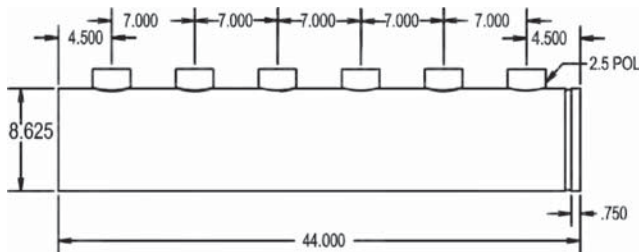
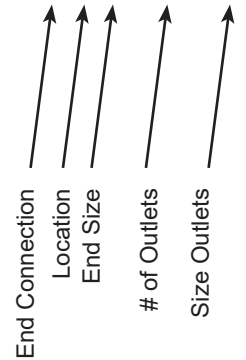

End Connection		Location		End Size		# of Outlets		Outlet Size	
T	threaded	E	End	40	4"	20	2	25	2½" FNPT
G	grooved	B	Back	60	6"	30	3	30	3" FNPT
F	flanged	9	90°	80	8"	40	4	---	---
---	---	---	---	---	---	60	6	---	---

Two Way Male Outlet - Roof Connections



**Features:**

- Used to create roof connections, fire pump test connections, wall hydrants or sidewalk (free standing) hydrants
- provides 250 GPM minimum per outlet
- UL listed
- maximum operating pressure: **175 PSI at 70°F (21°C)**
- other configurations are available, contact Dixon® for additional information

**back outlet**

Pipe Size	(2) Outlets Male	Cast Brass	
		Part #	Price/E
4"	2½" NPT	<b>IRC4025</b>	<b>\$229.40</b>
	2½" NPT	<b>FRC4025</b>	<b>443.85</b>
	2½" NST (NH)	<b>IRC4025F</b>	<b>229.40</b>
	2½" NST (NH)	<b>FRC4025F</b>	<b>443.85</b>
6"	2½" NPT	<b>FRC6025</b>	<b>657.10</b>
	2½" NST (NH)	<b>FRC6025F</b>	<b>657.10</b>



Groove Size	(2) Outlets Male	Cast Brass	
		Part #	Price/E
4"	2½" NST (NH)	<b>IRC4025GF</b>	<b>\$229.40</b>



**Dimensions**

Size	A	B	C
4" x 2½" x 2½"	7-7/8"	5-3/16"	5-1/4"
6" x 2½" x 2½"	8-3/16"	6-3/8"	7-5/8"

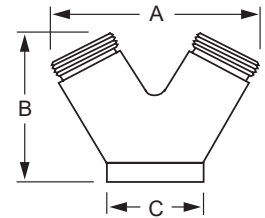

Two Way Male Outlet - Roof Connections

Pipe, Welding  
& Tube Fittings



**Features:**

- Used to create roof connections, fire pump test connections, wall hydrants or sidewalk (free standing) hydrants
- provides 250 GPM minimum per outlet
- UL listed
- maximum operating pressure: **175 PSI at 70°F (21°C)**

**90° bottom outlet**



Pipe Size	(2) Outlets Male	Cast Brass	
		Part #	Price/E
4"	2½" NPT	<b>90IRC4025</b>	<b>\$269.95</b>
	2½" NPT	<b>90FRC4025</b>	<b>474.35</b>
	2½" NST (NH)	<b>90IRC4025F</b>	<b>269.95</b>
	2½" NST (NH)	<b>90FRC4025F</b>	<b>474.35</b>
6"	2½" NPT	<b>90FRC6025</b>	<b>656.30</b>
	2½" NST (NH)	<b>90FRC6025F</b>	<b>656.30</b>



Groove Size	(2) Outlets Male	Cast Brass	
		Part #	Price/E
4"	2½" NPT	<b>90IRC4025G</b>	<b>\$274.20</b>
	2½" NST(NH)	<b>90IRC4025GF</b>	<b>274.20</b>

**Dimensions**

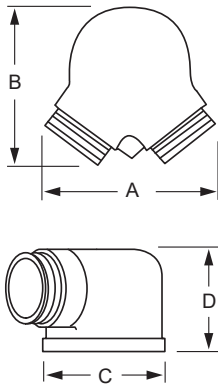

Size	A	B	C	D
4" x 2½" x 2½"	7½"	6¾"	5⅛"	4½"
6" x 2½" x 2½"	9"	8½"	7½"	5"



Three Way Male Outlet - Roof Connections

Features:

- used to create roof connections, or fire pump test connections
- provides 250 GPM minimum per outlet

Pipe, Welding & Tube Fittings

back outlet

Pipe Size	(3) Outlets Male	Cast Brass	
		Part #	Price/E
4"	2½" NPT	<b>FR3C4025</b>	<b>\$925.95</b>
6"	2½" NPT	<b>FR3C6025</b>	<b>2072.55</b>
	2½" NST (NH)	<b>FR3C6025F</b>	<b>2197.40</b>



Dimensions

Size	A	B	C
4" x 2½" x 2½" x 2½"	12¾"	8¾"	5¼"
6" x 2½" x 2½" x 2½"	15⅝"	9¾"	7⅝"

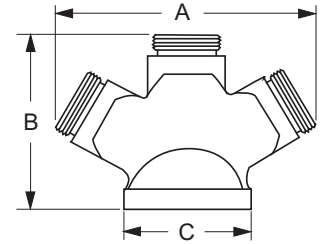

bottom outlet

Pipe Size	(3) Outlets Male	Cast Brass	
		Part #	Price/E
4"	2½" NPT	<b>90FR3C4025</b>	<b>\$2071.70</b>
	2½" NST (NH)	<b>90FR3C4025F</b>	<b>2071.70</b>
6"	2½" NPT	<b>90FR3C6025</b>	<b>1404.10</b>
	2½" NST (NH)	<b>90FR3C6025F</b>	<b>1404.10</b>



Dimensions

Size	A	B	C	D
4" x 2½" x 2½" x 2½"	7¾"	11¾"	4-7/16"	6¼"
6" x 2½" x 2½" x 2½"	7¾"	11¾"	4-7/16"	6¼"

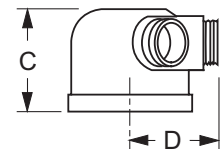
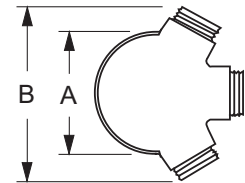

Sleeve for Sidewalk (free standing) Connections

Features:

- used in conjunction with a sidewalk escutcheon and a 90° double clapper Siamese to create a sidewalk (free standing) fire department connection
- finishes: -P polished, -C polished chrome plated

Pipe Size	Length	Brass	
		Part #	Price/E
4"	18"	<b>SS418-P</b>	<b>\$589.95</b>
	18"	<b>SS418-C</b>	<b>652.95</b>
	24"	<b>SS424-P</b>	<b>538.40</b>
	24"	<b>SS424-C</b>	<b>630.00</b>
6"	18"	<b>SS618-P</b>	<b>589.95</b>
	18"	<b>SS618-C</b>	<b>813.30</b>
	24"	<b>SS624-P</b>	<b>893.50</b>
	24"	<b>SS624-C</b>	<b>1071.00</b>



Round **Identification Plates**



REP250AS-C



REP250AS-P



REP400AS



**Features:**

- used to trim out and identify exposed fire department connections
- for Siamese, made in 9¼" diameter for 4" pipe and 11¼" diameter for 6" pipe
- finishes: -P polished, -C polished chrome plated

Pipe Size	Branding	Cast Brass	
		Part #	Price/E
2½"	Auto-Sprinkler	<b>REP250AS</b>	<b>\$90.45</b>
	Auto-Sprinkler	<b>REP250AS-P</b>	<b>132.95</b>
	Auto-Sprinkler	<b>REP250AS-C</b>	<b>162.70</b>
	Wall Hydrant	<b>REP250HY</b>	<b>90.45</b>
	Pump Test	<b>REP250PT</b>	<b>90.45</b>
	Standpipe	<b>REP250SP</b>	<b>90.45</b>
	Standpipe	<b>REP250SP-P</b>	<b>132.95</b>
	Standpipe	<b>REP250SP-C</b>	<b>162.70</b>
4"	Auto-Sprinkler	<b>AREP400AS</b> <sup>1</sup>	<b>30.50</b>
	Auto-Sprinkler	<b>REP400AS</b>	<b>181.80</b>
	Auto-Sprinkler	<b>REP400AS-P</b>	<b>209.30</b>
	Auto-Sprinkler	<b>REP400AS-C</b>	<b>268.55</b>
	Wall Hydrant	<b>REP400HY</b>	<b>181.80</b>
	Standpipe	<b>REP400SP</b>	<b>181.80</b>
	Standpipe	<b>REP400SP-P</b>	<b>209.30</b>
	Standpipe	<b>REP400SP-C</b>	<b>268.55</b>
Auto-Sprinkler & Standpipe	<b>REP400AS/SP</b>	<b>209.30</b>	
6"	Auto-Sprinkler	<b>REP600AS</b>	<b>231.40</b>
	Auto-Sprinkler	<b>REP600AS-P</b>	<b>246.85</b>
	Auto-Sprinkler	<b>REP600AS-C</b>	<b>320.75</b>
	Standpipe	<b>REP600SP</b>	<b>231.40</b>
	Standpipe	<b>REP600SP-P</b>	<b>246.85</b>
	Standpipe	<b>REP600SP-C</b>	<b>320.75</b>

<sup>1</sup> aluminum

Dimensions

Size	OD	Hole Size
2½"	7⅞"	3¼"
4"	9¼"	4⅝"
6"	11¼"	6¾"

British Instantaneous Fittings

Features:

- polished finish
- meets BS336 specifications

Pipe, Welding  
& Tube Fittings

British Instantaneous female x female threads

Female BRIT Thread	Female Thread	Part #	Brass	
				Price/E
2½"	2½" NST (NH)	<b>BID250F</b>		<b>\$139.00</b>
	2½" NPT	<b>BID250T</b>		<b>139.00</b>
	2½" BSP	<b>BID250B</b>		<b>139.00</b>



British Instantaneous female x male threads

Female BRIT Thread	Male Thread	Part #	Brass	
				Price/E
2½"	2½" NST (NH)	<b>BIB250F</b>		<b>\$129.00</b>
	2½" NPT	<b>BIB250T</b>		<b>129.00</b>



British Instantaneous male x female threads

Male BRIT Thread	Female Thread	Part #	Brass	
				Price/E
2½"	2½" NST (NH)	<b>BIA250F</b>		<b>\$102.00</b>
	2½" NPT	<b>BIA250T</b>		<b>102.00</b>



British Instantaneous male x male threads

Male BRIT Thread	Male Thread	Part #	Brass	
				Price/E
2½"	2½" NST (NH)	<b>BIF250F</b>		<b>\$97.95</b>
	2½" NPT	<b>BIF250T</b>		<b>97.95</b>



British Instantaneous Fittings

British Instantaneous Plug



Size	Part #	Brass	Price/E
2½"	<b>BIDP250</b>		<b>\$61.65</b>

British Instantaneous Cap



Size	Part #	Brass	Price/E
2½"	<b>BIDC250</b>		<b>\$126.00</b>

British Instantaneous Hose Shanks



BIE150

Size	Part #	Brass	Price/E
2½" male BRIT x 1½" hose shank	<b>BIE150</b>		<b>\$118.00</b>
2½" male BRIT x 2½" hose shank	<b>BIE250</b>		<b>125.00</b>
2½" female BRIT x 1½" hose shank	<b>BIC150</b>		<b>130.00</b>
2½" female BRIT x 2½" hose shank	<b>BIC250</b>		<b>143.00</b>



BIC150

International Shore Connections

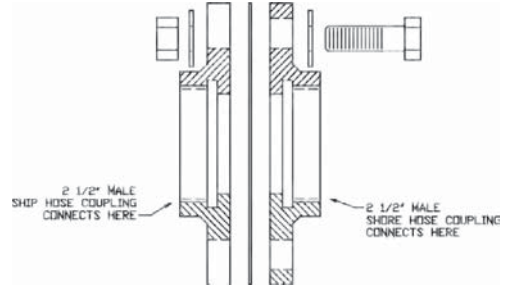
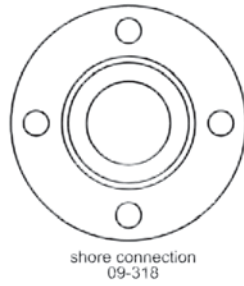
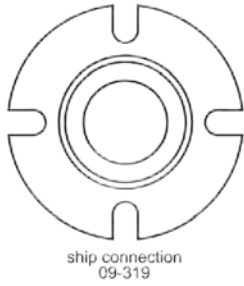

Pipe, Weldings  
& Tube Fittings

**Features:**

- meets US Coast Guard specifications for vessels 1000 gross tons or more
- makes possible the connection of two different threads between ship and shore or between ships
- 7" OD brass flange with 4 3/4" holes
- includes 8 washers, 4 hexagon brass nuts, 4 hex head bolts, 1 washer, 1 fiber gasket
- working pressure: **300 PSI**
- NST (NH) threads standard, also available in NPT and NYFD threads



Description	Part #	Brass	
			Price/E
shore side	<b>09-318-00001</b>		<b>\$594.95</b>
ship side	<b>09-319-00001</b>		<b>628.25</b>



Dry Hydrants

Typical Dry Hydrant Installations

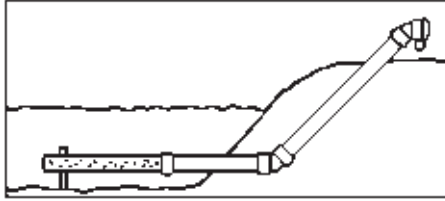

45°  
(preferred)

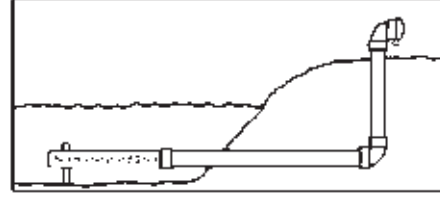

90°

Note: all dry hydrant products on this page will be discontinued once stock is depleted.

Underwater Strainer Support



Part #	Price/E
<b>DHSSC6</b>	<b>\$154.40</b>

Back Flushing Strainers



Size	Length	Schedule 40 PVC	
		Part #	Price/E
6"	37"	<b>DHS6BF</b>	<b>\$397.85</b>
8"		<b>DHS8BF<sup>1</sup></b>	<b>767.25</b>

<sup>1</sup> includes 8" x 6" reducer

Male Adapters and Caps



cap is included

90° Male Adapters

45° Male Adapters

Male NST (NH) Thread	Schedule 40 PVC			
	Part #	Price/E	Part #	Price/E
4½"	<b>ADH90M45F</b>	<b>\$553.45</b>	<b>ADH45M45F</b>	<b>\$553.45</b>
6"	<b>ADH90M60F</b>	<b>746.70</b>	<b>ADH45M60F</b>	<b>746.70</b>

Rocker Lug Caps with Cable

Female NST (NH) Thread	Hardcoated	
	Part #	Price/E
4½"	<b>ADHC450F</b>	<b>\$306.60</b>
6"	<b>ADHC600F</b>	<b>365.80</b>

Female Adapters and Plugs



plug is included

90° Female Adapters

45° Female Adapters

Female NST (NH) Thread	Hardcoated			
	Part #	Price/E	Part #	Price/E
4½"	<b>ADH90F45F</b>	<b>\$746.70</b>	<b>ADH45F45F</b>	<b>\$553.45</b>
6"	<b>ADH90F60F</b>	<b>746.70</b>	<b>ADH45F60F</b>	<b>746.70</b>

Rocker Lug Plugs with Cable

Male NST (NH) Thread	Hardcoated	
	Part #	Price/E
4½"	<b>ADHP450F</b>	<b>\$306.60</b>
6"	<b>ADHP600F</b>	<b>365.80</b>



Dixon® Low Level Strainer

**Application:**

- can be used as a low level strainer and as a water transfer device

**Features:**

- pivoting elbow enables the base to sit flat on the bottom of a portable tank
- base: 1/8" thick 5052 H32 marine grade aluminum, powder coated red with 45° angled edges, carrying handle mounted to base
- allows the user to draft within 2" of the bottom of the tank without whirlpooling
- jet is constructed from 3/4" pipe
- supplied with 304 stainless steel mesh strainer for fast fill flowing
- shipped with 1 1/2" male NPSH plug with wire cable attached to base
- elbow: 6" aluminum tube 6061-T6, powder coated red
- posts: welded between upper and lower base, 6061-T6 aluminum
- siphon jet: 3/4" ID 6061-T6 aluminum pipe, powder coated red
- elbow pivot rod: 1/4" thick, 304 stainless steel
- washers: polypropylene used for ease of elbow pivot and longer wear
- pivot bracket: 3/16" thick x 1 1/2" x 1 1/2", angle 6061-T6 aluminum
- 6" swivel: long handle, black anodized, 6061-T6 aluminum

**Threaded Female Swivel with Jet Siphon**

Thread	1 1/2" NPSH Part #	Price/E	1 1/2" NST (NH) Part #	Price/E
5" NST (NH)	<b>NCS-LLSJ-50FS</b>	<b>\$1101.25</b>	<b>NCS-LLSJ-50FF</b>	<b>\$1431.85</b>
6" NST (NH)	<b>NCS-LLSJ-60FS</b>	<b>856.25</b>	<b>NCS-LLSJ-60FF</b>	<b>1129.90</b>



with siphon jet

**Threaded Female Swivel without Jet Siphon**

Thread	Part #	Price/E
5" NST (NH)	<b>NCS-LL-50F</b>	<b>\$891.35</b>
6" NST (NH)	<b>NCS-LL-60F</b>	<b>774.00</b>



Barrel and Basket Strainers

Features:

- lightweight
- full-flow design
- rocker lugs
- tie off hook for drafting placement

Barrel Strainers - Female Threaded



Size	Hardcoat, Anodized Aluminum	
	NST (NH) Part #	Price/E
2½"	<b>FST250F</b>	<b>\$321.90</b>
3"	<b>FST300F</b>	<b>340.30</b>
4"	<b>FST400F</b>	<b>507.35</b>
6"	<b>FST600F</b>	<b>634.30</b>

Barrel Strainers - Storz



Size	Hardcoat, Anodized Aluminum	
	Part #	Price/E
4"	<b>ST400</b>	<b>\$434.45</b>
5"	<b>ST500</b>	<b>960.65</b>
6"	<b>ST600</b>	<b>787.50</b>

Basket Strainers - Female Threaded



Size	Hardcoat, Anodized Aluminum	
	NST (NH) Part #	Price/E
2½"	<b>BSKTST250F</b>	<b>\$372.30</b>
3"	<b>BSKTST300F</b>	<b>389.50</b>
4"	<b>BSKTST400F</b>	<b>515.50</b>
5"	<b>BSKTST500F</b>	<b>630.00</b>
6"	<b>BSKTST600F</b>	<b>601.40</b>

Floating Strainers

Feature:

- steel screen

**Female Swivel**

Female Inlet	Aluminum			
	NST (NH) Part #	Price/E	NPSH Part #	Price/E
5"	<b>NCS-FDFS-50F</b>	<b>\$1548.95</b>	<b>NCS-FDFS-50S</b>	<b>\$1548.95</b>
6"	<b>NCS-FDFS-60F</b>	<b>1548.95</b>	<b>NCS-FDFS-60S</b>	<b>1548.95</b>



Pipe, Welding  
& Tube Fittings

**Storz**

Storz Inlet	Aluminum	
	Part #	Price/E
5"	<b>NCS-FDSTZ-50</b>	<b>\$1689.55</b>
6"	<b>NCS-FDSTZ-60</b>	<b>1522.15</b>



Tank Round Hole Strainers

Female NPT	Cast Brass	
	Part #	Price/E
5"	<b>BS500</b>	<b>\$621.05</b>
6"	<b>BS600</b>	<b>1726.85</b>
8"	<b>BS800</b>	<b>2459.70</b>



Clamps

Service pressure ratings are based on the following parameters: matching elastomer gaskets and weld ferrules properly aligned and assembled with the clamps tightened to the required torque (25 in. lbs.). Tests are done hydrostatically with no water hammer or shock loads. Please note the pressure ratings of the described unions are above the recommended pipe line operating pressures. 

Pipe, Welding & Tube Fittings

Dimensions are approximate. Engineering dimensions are available upon request. Specifications are subject to change without notice.

Single Pin Squeeze Clamps - 13MHHM-Q

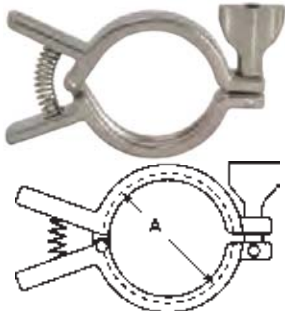

Tube OD	Service Pressure PSI Rating @ 70°F (21°C) <sup>1</sup>	Service Pressure PSI Rating @ 250°F (121°C) <sup>1</sup>	Dimension A	Stainless Steel	
				Part #	Price/E
1/2" - 3/4"	1500	1200	1.062"	13MHHM-Q75	\$32.36
1" - 1 1/2"	500	300	2.122"	13MHHM-Q100150	39.32
2"	450	250	2.654"	13MHHM-Q200	45.88
2 1/2"	400	200	3.185"	13MHHM-Q250	59.07
3"	350	175	3.717"	13MHHM-Q300	66.39
4"	300	150	4.820"	13MHHM-Q400	76.96

Single Pin Heavy Duty Clamps - 13MHHM  
with cross hole wing nut



Tube OD	Service Pressure PSI Rating @ 70°F (21°C) <sup>1</sup>	Service Pressure PSI Rating @ 250°F (121°C) <sup>1</sup>	Dimension A	Stainless Steel	
				Part #	Price/E
1/2" - 3/4"	1500	1200	1.062"	13MHHM50-75	\$9.19
1" - 1 1/2"	500	300	2.122"	13MHHM100-150	13.93
2"	450	250	2.654"	13MHHM200	16.89
2 1/2"	400	200	3.185"	13MHHM250	19.66
3"	350	175	3.717"	13MHHM300	21.81
4"	300	150	4.820"	13MHHM400	26.12
5"	225	100	5.820"	13MHHM500	57.84
6"	150	75	6.695"	13MHHM600	57.51
8"	100	50	8.695"	13MHHM800	82.87

Single Pin Heavy Duty Clamps - 13MHHM\*\*\*SN  
with serrated wing nut



Tube OD	Service Pressure PSI Rating @ 70°F (21°C) <sup>1</sup>	Service Pressure PSI Rating @ 250°F (121°C) <sup>1</sup>	Dimension A	Stainless Steel	
				Part #	Price/E
1/2" - 3/4"	1500	1200	1.062"	13MHHM50-75SN	\$9.19
1" - 1 1/2"	500	300	2.122"	13MHHM100-150SN	13.93
2"	450	250	2.654"	13MHHM200SN	16.89
2 1/2"	400	200	3.185"	13MHHM250SN	19.66
3"	350	175	3.717"	13MHHM300SN	21.81
4"	300	150	4.820"	13MHHM400SN	26.12
5"	225	100	5.820"	13MHHM500SN	57.84
6"	150	75	6.695"	13MHHM600SN	57.51
8"	100	50	8.695"	13MHHM800SN	82.58

Double Pin Heavy Duty Clamps - 13MHHM-DP



Tube OD	Service Pressure PSI Rating @ 70°F (21°C) <sup>1</sup>	Service Pressure PSI Rating @ 250°F (121°C) <sup>1</sup>	Dimension A	Stainless Steel	
				Part #	Price/E
1" - 1 1/2"	500	300	2.122"	13MHHM-DP100150	\$18.84
2"	450	250	2.654"	13MHHM-DP200	21.22
2 1/2"	400	200	3.185"	13MHHM-DP250	27.00
3"	350	175	3.717"	13MHHM-DP300	30.46
4"	300	150	4.820"	13MHHM-DP400	32.77
10"	100	50	10.740"	13MHHM-DP1000	280.05

<sup>1</sup> wing nut tightened to 25 in. lb. of torque

Clamps

Three Segment Clamps - 13MHHM-3P

Tube OD	Service Pressure PSI Rating @ 70°F (21°C) <sup>1</sup>	Service Pressure PSI Rating @ 250°F (121°C) <sup>1</sup>	Dimension A	Stainless Steel	
				Part #	Price/E
1" - 1½"	600	300	2.122"	13MHHM-3P100150	\$28.43
2"	550	275	2.654"	13MHHM-3P200	31.88
2½"	450	225	3.185"	13MHHM-3P250	38.27
3"	350	175	3.717"	13MHHM-3P300	44.58
4"	300	150	4.820"	13MHHM-3P400	54.32
12"	75	50	12.740"	13MHHM-3P1200	642.41



Pipe, Welding  
& Tube Fittings

<sup>1</sup> wing nut should be tightened to 25 in. lb. of torque

Bolted Clamps - 13MHP

Tube OD	Service Pressure PSI Rating @ 70°F (21°C) <sup>1</sup>	Service Pressure PSI Rating @ 250°F (121°C) <sup>1</sup>	Dimension A	Stainless Steel	
				Part #	Price/E
½" - ¾"	1500	1200	1.062"	13MHP75	\$28.92
1" - 1½"	1500	1200	2.046"	13MHP100-150	28.80
2"	1000	800	2.578"	13MHP200	35.88
2½"	1000	800	3.110"	13MHP250	39.50
3"	1000	800	3.640"	13MHP300	49.17
4"	800	600	4.744"	13MHP400	51.64
6"	300	200	6.632"	13MHP600	92.39
8"	250	150	8.638"	13MHP800	192.73
10"	200	125	10.740"	13MHP1000	220.98
12"	150	100	12.740"	13MHP1200	260.02

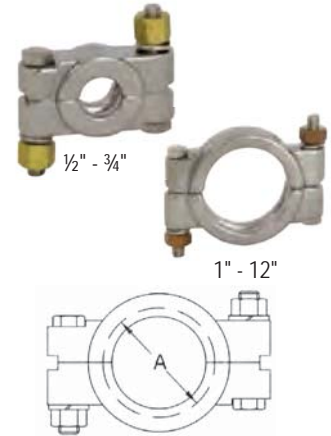

<sup>1</sup> nuts should be tightened to 20 ft. lbs. of torque

Toggle Clamps - 13MHLA

Tube OD	Service Pressure PSI Rating @ 70°F (21°C) <sup>1</sup>	Service Pressure PSI Rating @ 250°F (121°C) <sup>1</sup>	Dimension A	304 Stainless Steel	
				Part #	Price/E
1" - 1½"	150	125	2.122"	13MHLA100-150	\$34.83
2"	150	125	2.654"	13MHLA200	36.69
2½"	150	125	3.185"	13MHLA250	40.76
3"	150	125	3.717"	13MHLA300	58.89
4"	100	75	4.820"	13MHLA400	67.68



<sup>1</sup> screw tightened to maximum

T-bolt Clamps - 13MO

Tube OD	Service Pressure PSI Rating @ 70°F (21°C) <sup>1</sup>	Service Pressure PSI Rating @ 250°F (121°C) <sup>1</sup>	Dimension A	304 Stainless Steel	
				Part #	Price/E
1" - 1½"	500	250	2.080"	13MO100-150	\$30.46
2"	350	200	2.610"	13MO200	34.67
2½"	300	150	3.140"	13MO250	42.49
3"	200	100	3.670"	13MO300	43.73
4"	100	75	4.780"	13MO400	57.61
6"	75	50	6.690"	13MO600	84.17
8" <sup>1</sup>	50	40	8.690"	13MO800	125.52
10" <sup>1</sup>	40	30	10.690"	13MO1000	164.71
12" <sup>1</sup>	30	25	12.690"	13MO1200	222.22



<sup>1</sup> 2 bolt configuration

<sup>2</sup> 1" - 3" nuts tightened to 20 in. lb., 4" nut tightened to 30 in. lb., 6" nut tightened to 40 in. lb. and 8" - 12" nuts tightened to 50 in. lb. of torque

Clamps

Dairy Clamps - 13WGC



Tube OD	Service Pressure PSI Rating @ 70°F (21°C) <sup>1</sup>	Dimension A	304 Stainless Steel	
			Part #	Price/E
1" - 1½"	80	2.080"	13WGC100-150	\$13.19
2"	80	2.610"	13WGC200	13.76
2½"	60	3.140"	13WGC250	16.96
3"	40	3.670"	13WGC300	18.19
4"	40	4.780"	13WGC400	21.55

<sup>1</sup> finger tight

Accessories

Spring Loaded Nut - 13SLN



Features:

- Beneficial for lines using PTFE gaskets that are subject to large temperature swings, as the PTFE is compressed through the cycling of the lines, the spring load will help keep the connection from leaking.
- If the lines suffer from vibration and bolted clamps are not an option, refitting single pin clamps with this nut will keep the connections from leaking for a longer time than with standard wing nuts.
- Spring loaded nuts can add a level of insurance to shipments, of transported material in tanks via truck, where vibrations can loosen the standard single pin clamps.
- can be used on all wing nut style clamps
- torque to 50 in. lb.

Thread	Dimension A	Dimension B	304 Stainless Steel	
			Part #	Price/E
5/16" - 18	1.73"	.875"	13SLN	\$90.18

Nuts and Bolts



Description	Part #	Price/E
cross hole wing nut 5/16"-18	13WNX	\$11.39
mini cross hole wing nut 5/16"-18, for 1/2" - 3/4" clamps	13WNXM	11.88
serrated wing nut 5/16"-18	13WNS	11.22
hex wing nut 5/16"-18	13WNH	7.41
bronze hex nut 3/8"-16, for bolted clamps	13BN	3.25
bolt 3/8"-16 x 2-1/4", for 1-1/2" bolted clamps	13CB-2.25	8.24
bolt 3/8"-16 x 2-3/4", for 2" and 2-1/2" bolted clamps	13CB-2.75	8.24
bolt 3/8"-16 x 3¼", for 3" - 12" bolted clamps	13CB-3.25	8.24
rivet pin, for 1/2" - 5" single pin clamps 5/16" x 1"	13RP	2.87
rivet pin, for 6" and 8" single pin clamps 5/16" x 1-1/8"	13RP6	2.05
5/16"-18 x 2" threaded eye bolt, for 1/2" - 5" clamps	13IB	2.82
5/16"-18 x 2-1/2" threaded eye bolt, for 6" - 12" clamps	13IB6	3.08
brass 3/8"-16 nuts, for 10" and 12" bolted clamps	13BNH	3.98
stainless steel hex nut, for bolted clamps	13SN	1.00
3/8" lockwasher 304 stainless steel, for bolted clamps	13LW	0.19



Clamp Fittings - Ferrules

Short Weld Ferrules - 14WMP

Pipe, Welding  
& Tube Fittings

Tube OD	Dimensions			304 Stainless Steel		316L Stainless Steel	
	A	B	C	Part #	Price/E	Part #	Price/E
1/2"	.500"	.370"	.500"	<b>14WMP-G50</b>	<b>\$6.36</b>	<b>14WMP-R50</b>	<b>\$9.21</b>
3/4"	.500"	.620"	.750"	<b>14WMP-G75</b>	<b>6.88</b>	<b>14WMP-R75</b>	<b>9.21</b>
1"	.500"	.870"	1.000"	<b>14WMP-G100</b>	<b>6.88</b>	<b>14WMP-R100</b>	<b>8.77</b>
1 1/2"	.500"	1.370"	1.500"	<b>14WMP-G150</b>	<b>6.88</b>	<b>14WMP-R150</b>	<b>8.77</b>
2"	.500"	1.870"	2.000"	<b>14WMP-G200</b>	<b>7.42</b>	<b>14WMP-R200</b>	<b>10.24</b>
2 1/2"	.500"	2.370"	2.500"	<b>14WMP-G250</b>	<b>11.32</b>	<b>14WMP-R250</b>	<b>16.16</b>
3"	.500"	2.870"	3.000"	<b>14WMP-G300</b>	<b>14.21</b>	<b>14WMP-R300</b>	<b>20.12</b>
4"	.625"	3.834"	4.000"	<b>14WMP-G400</b>	<b>22.37</b>	<b>14WMP-R400</b>	<b>29.02</b>
5"	.750"	4.782"	5.000"	<b>14WMP-G500</b>	<b>368.59</b>	<b>14WMP-R500</b>	<b>553.85</b>
6"	.875"	5.782"	6.000"	<b>14WMP-G600</b>	<b>78.27</b>	<b>14WMP-R600</b>	<b>122.88</b>
8"	.875"	7.760"	8.000"	<b>14WMP-G800</b>	<b>107.12</b>	<b>14WMP-R800</b>	<b>235.94</b>
10"	.875"	9.782"	10.000"	<b>14WMP-G1000</b>	<b>247.83</b>	<b>14WMP-R1000</b>	<b>314.68</b>
12"	.875"	11.760"	12.000"	<b>14WMP-G1200</b>	<b>400.15</b>	<b>14WMP-R1200</b>	<b>488.74</b>



Long Weld Ferrules - L14AM7

Tube OD	Dimensions			304 Stainless Steel		316L Stainless Steel	
	A	B	C	Part #	Price/E	Part #	Price/E
1/2"	1.125"	.370"	.500"	<b>L14AM7-G50</b>	<b>\$8.44</b>	<b>L14AM7-R50</b>	<b>\$10.76</b>
3/4"	1.125"	.620"	.750"	<b>L14AM7-G75</b>	<b>8.44</b>	<b>L14AM7-R75</b>	<b>10.76</b>
1"	1.125"	.870"	1.000"	<b>L14AM7-G100</b>	<b>9.67</b>	<b>L14AM7-R100</b>	<b>13.11</b>
1 1/2"	1.125"	1.370"	1.500"	<b>L14AM7-G150</b>	<b>9.67</b>	<b>L14AM7-R150</b>	<b>13.11</b>
2"	1.125"	1.870"	2.000"	<b>L14AM7-G200</b>	<b>11.93</b>	<b>L14AM7-R200</b>	<b>15.09</b>
2 1/2"	1.125"	2.370"	2.500"	<b>L14AM7-G250</b>	<b>15.78</b>	<b>L14AM7-R250</b>	<b>22.89</b>
3"	1.125"	2.870"	3.000"	<b>L14AM7-G300</b>	<b>20.30</b>	<b>L14AM7-R300</b>	<b>26.41</b>
4"	1.125"	3.834"	4.000"	<b>L14AM7-G400</b>	<b>27.77</b>	<b>L14AM7-R400</b>	<b>37.86</b>
6"	1.500"	5.782"	6.000"	<b>L14AM7-G600</b>	<b>120.33</b>	<b>L14AM7-R600</b>	<b>151.61</b>
8"	1.500"	7.760"	8.000"	<b>L14AM7-G800</b>	<b>156.54</b>	<b>L14AM7-R800</b>	<b>206.02</b>
10"	1.750"	9.782"	10.000"	<b>L14AM7-G1000</b>	<b>222.50</b>	<b>L14AM7-R1000</b>	<b>280.19</b>
12"	1.750"	11.760"	12.000"	<b>L14AM7-G1200</b>	<b>288.47</b>	<b>L14AM7-R1200</b>	<b>362.62</b>

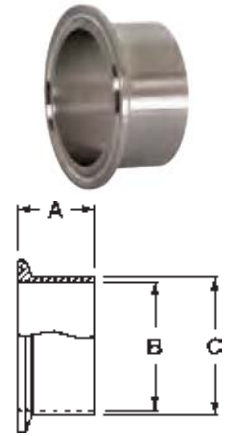

Automatic Weld Ferrules - TL14AM7

- Specification:**
- meets ASME BPE-2012 specifications

Tube OD	Dimensions			316L Stainless Steel	
	A	B	C	Part #	Price/E
1/2"	1.750"	.370"	.500"	<b>TL14AM7-050PL</b>	<b>\$17.50</b>
3/4"	1.750"	.620"	.750"	<b>TL14AM7-075PL</b>	<b>18.47</b>
1"	1.750"	.870"	1.000"	<b>TL14AM7-100PL</b>	<b>24.50</b>
1 1/2"	1.750"	1.370"	1.500"	<b>TL14AM7-150PL</b>	<b>24.87</b>
2"	2.250"	1.870"	2.000"	<b>TL14AM7-200PL</b>	<b>31.47</b>
3"	2.250"	2.870"	3.000"	<b>TL14AM7-300PL</b>	<b>47.17</b>
4"	2.250"	3.834"	4.000"	<b>TL14AM7-400PL</b>	<b>80.45</b>

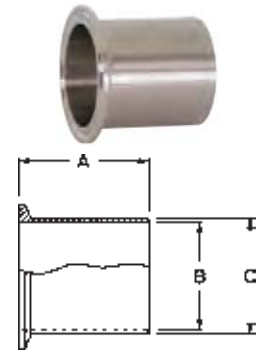

Tank Weld Ferrules (light duty) - 14WLMP

Tube OD	Dimensions			304 Stainless Steel		316L Stainless Steel	
	A	B	C	Part #	Price/E	Part #	Price/E
1"	3.000"	.870"	1.000"	<b>14WLMP-G100</b>	<b>\$25.99</b>	<b>14WLMP-R100</b>	<b>\$45.27</b>
1 1/2"	3.000"	1.370"	1.500"	<b>14WLMP-G150</b>	<b>31.44</b>	<b>14WLMP-R150</b>	<b>55.97</b>
2"	3.000"	1.870"	2.000"	<b>14WLMP-G200</b>	<b>34.82</b>	<b>14WLMP-R200</b>	<b>40.36</b>
2 1/2"	3.000"	2.370"	2.500"	<b>14WLMP-G250</b>	<b>49.20</b>	<b>14WLMP-R250</b>	<b>78.43</b>
3"	4.000"	2.870"	3.000"	<b>14WLMP-G300</b>	<b>65.93</b>	<b>14WLMP-R300</b>	<b>102.65</b>
4"	4.000"	3.834"	4.000"	<b>14WLMP-G400</b>	<b>95.47</b>	<b>14WLMP-R400</b>	<b>104.68</b>
6"	6.000"	5.782"	6.000"	<b>14WLMP-G600</b>	<b>338.92</b>	<b>14WLMP-R600</b>	<b>423.46</b>

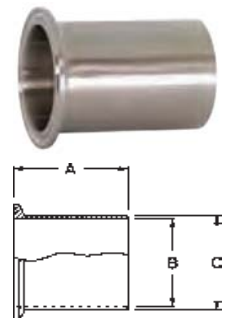

Clamp Fittings - Ferrules

Tank Weld Ferrules (heavy duty) - 14MPW

Specification:

- certified ASME materials

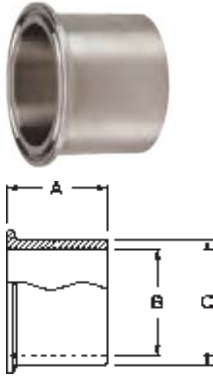

Tube OD	Dimensions			316L Stainless Steel	
	A	B	C	Part #	Price/E
1/2"	1.625"	.321"	.502"	<b>14MPW-R50</b>	<b>\$35.31</b>
3/4"	1.625"	.574"	.750"	<b>14MPW-R75</b>	<b>35.31</b>
1"	1.625"	.870"	1.160"	<b>14MPW-R100</b>	<b>32.69</b>
1 1/2"	1.625"	1.370"	1.676"	<b>14MPW-R150</b>	<b>32.69</b>
2"	1.750"	1.870"	2.192"	<b>14MPW-R200</b>	<b>42.52</b>
2 1/2"	1.750"	2.370"	2.708"	<b>14MPW-R250</b>	<b>61.18</b>
3"	1.813"	2.870"	3.224"	<b>14MPW-R300</b>	<b>80.94</b>
4"	2.125"	3.834"	4.256"	<b>14MPW-R400</b>	<b>133.78</b>
6"	2.500"	5.758"	6.192"	<b>14MPW-R600</b>	<b>373.16</b>

Roll-on Ferrules for Expanding - 14RMP



Tube OD	Dimensions		304 Stainless Steel		316L Stainless Steel	
	A	B	Part #	Price/E	Part #	Price/E
1"	.750"	1.005"	<b>14RMP-G100</b>	<b>\$12.39</b>	<b>14RMP-R100</b>	<b>\$19.30</b>
1 1/2"	1.125"	1.505"	<b>14RMP-G150</b>	<b>12.76</b>	<b>14RMP-R150</b>	<b>19.71</b>
2"	1.312"	2.005"	<b>14RMP-G200</b>	<b>14.75</b>	<b>14RMP-R200</b>	<b>21.15</b>
2 1/2"	1.375"	2.505"	<b>14RMP-G250</b>	<b>21.05</b>	<b>14RMP-R250</b>	<b>32.69</b>
3"	1.437"	3.005"	<b>14RMP-G300</b>	<b>26.30</b>	<b>14RMP-R300</b>	<b>49.07</b>
4"	1.500"	4.005"	<b>14RMP-G400</b>	<b>33.18</b>	<b>14RMP-R400</b>	<b>53.07</b>

<sup>1</sup> Meets 3-A Standard Number 63-03 when used to modify or repair existing on-site farm milk handling systems.

Reducing Ferrules - B31WMP

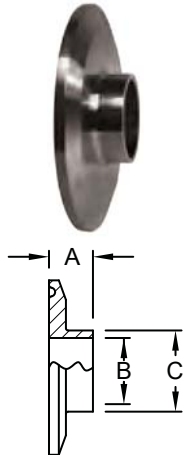

Tube OD	Dimensions			304 Stainless Steel	
	A	B	C	Part #	Price/E
2" x 1"	.500"	.870"	1.000"	<b>B31WMP-G200100</b>	<b>\$145.20</b>
2 1/2" x 1 1/2"	.500"	1.370"	1.500"	<b>B31WMP-G250150</b>	<b>30.74</b>
2 1/2" x 2"	.500"	1.870"	2.000"	<b>B31WMP-G250200</b>	<b>199.71</b>
3" x 2"	.500"	1.870"	2.000"	<b>B31WMP-G300200</b>	<b>242.61</b>
4" x 3"	.625"	2.870"	3.000"	<b>B31WMP-G400300</b>	<b>384.61</b>

Clamp Fittings - Caps

Solid End Caps - 16AMP

- Specify if you are using a piping system or a tubing system when ordering.

Tube OD	Dimensions		304 Stainless Steel		316L Stainless Steel	
	A	B	Part #	Price/E	Part #	Price/E
½" - ¾"	.187"	.992"	<b>16AMP-G50-75</b>	<b>\$6.32</b>	<b>16AMP-R50-75</b>	<b>\$7.75</b>
1" - 1½"	.250"	1.984"	<b>16AMP-G100-150</b>	<b>6.73</b>	<b>16AMP-R100-150</b>	<b>8.34</b>
2"	.250"	2.516"	<b>16AMP-G200</b>	<b>8.55</b>	<b>16AMP-R200</b>	<b>12.11</b>
2½"	.250"	3.047"	<b>16AMP-G250</b>	<b>13.06</b>	<b>16AMP-R250</b>	<b>18.30</b>
3"	.250"	3.579"	<b>16AMP-G300</b>	<b>17.63</b>	<b>16AMP-R300</b>	<b>24.23</b>
4"	.312"	4.682"	<b>16AMP-G400</b>	<b>33.46</b>	<b>16AMP-R400</b>	<b>44.48</b>
5"	.376"	5.687"	<b>16AMP-G500</b>	<b>480.77</b>	<b>16AMP-R500</b>	<b>86.73</b>
6"	.437"	6.570"	<b>16AMP-G600</b>	<b>112.05</b>	<b>16AMP-R600</b>	<b>154.67</b>
8"	.437"	8.570"	<b>16AMP-G800</b>	<b>246.87</b>	<b>16AMP-R800</b>	<b>271.79</b>
10"	.437"	10.570"	<b>16AMP-G1000</b>	<b>440.19</b>	<b>16AMP-R1000</b>	<b>783.69</b>
12"	.437"	12.750"	<b>16AMP-G1200</b>	<b>617.24</b>	<b>16AMP-R1200</b>	<b>1051.38</b>



Pipe, Welding & Tube Fittings

Thermometer Caps - B23BMP

Tube OD	Dimensions			304 Stainless Steel		316L Stainless Steel	
	A	B	C <sup>1</sup>	Part #	Price/E	Part #	Price/E
½"	.500"	.993"	¼" NPT	---	---	<b>B23BMP-R5014</b>	<b>\$207.69</b>
¾"	.500"	.993"	¼" NPT	---	---	<b>B23BMP-R7514</b>	<b>230.78</b>
1"	.625"	1.984"	½" NPT	<b>B23BMP-G100</b>	<b>\$33.46</b>	<b>B23BMP-R100</b>	<b>49.96</b>
1½"	.625"	1.984"	¾" NPT	<b>B23BMP-G150</b>	<b>33.46</b>	<b>B23BMP-R150</b>	<b>49.96</b>
2"	.625"	2.516"	¾" NPT	<b>B23BMP-G200</b>	<b>44.07</b>	<b>B23BMP-R200</b>	<b>66.34</b>
2½"	.625"	3.047"	¾" NPT	<b>B23BMP-G250</b>	<b>60.57</b>	<b>B23BMP-R250</b>	<b>91.15</b>
3"	.625"	3.579"	¾" NPT	<b>B23BMP-G300</b>	<b>78.12</b>	<b>B23BMP-R300</b>	<b>116.54</b>
4"	.625"	4.682"	¾" NPT	<b>B23BMP-G400</b>	<b>114.58</b>	<b>B23BMP-R400</b>	<b>169.84</b>

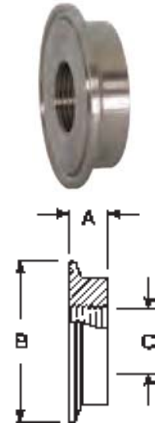

<sup>1</sup> other NPT tap sizes available, contact Dixon®

Clamp Fittings - Adapters

Tygon® Hose Adapters - 14MPHT

Tube OD	Dimensions			316L Stainless Steel	
	A	B	C	Part #	Price/E
¾"	4.000"	.620"	.750"	<b>14MPHT-R75</b>	<b>\$96.00</b>
1"	4.500"	.870"	1.000"	<b>14MPHT-R100</b>	<b>58.38</b>
1½"	4.500"	1.370"	1.500"	<b>14MPHT-R150</b>	<b>49.71</b>
2"	4.500"	1.870"	2.000"	<b>14MPHT-R200</b>	<b>50.20</b>
2½"	4.500"	2.370"	2.500"	<b>14MPHT-R250</b>	<b>85.97</b>
3"	4.500"	2.870"	3.000"	<b>14MPHT-R300</b>	<b>72.52</b>
4"	4.625"	3.834"	4.000"	<b>14MPHT-R400</b>	<b>157.62</b>

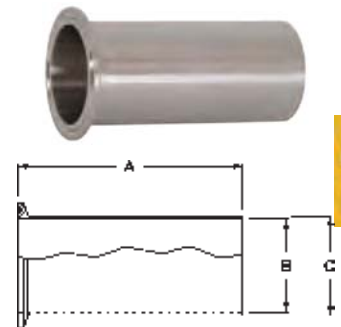

Clamp Fittings - Adapters

Pipe, Welding & Tube Fittings

Rubber Hose Adapters - 14MPHR

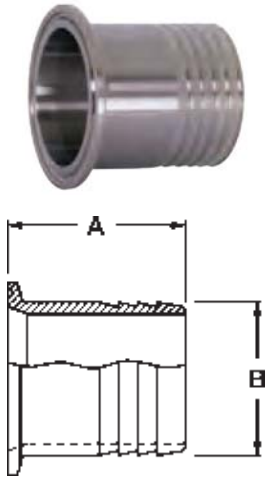

Tube OD	Hose Size	Dimensions		304 Stainless Steel		316L Stainless Steel	
		A	B	Part #	Price/E	Part #	Price/E
1/2"	1/4"	1.500"	.250"	---	---	14MPHR-R5025	\$93.21
	1/2"	1.500"	.500"	---	---	14MPHR-R50	83.35
	3/4"	1.500"	.750"	---	---	14MPHR-R5075	123.29
3/4"	1/4"	1.500"	.250"	---	---	14MPHR-R7525	99.29
	3/8"	1.500"	.375"	---	---	14MPHR-R75375	99.29
	1/2"	1.500"	.500"	---	---	14MPHR-R7550	93.21
	3/4"	1.500"	.750"	---	---	14MPHR-R75	83.35
1"	3/8"	1.500"	.375"	---	---	14MPHR-R100375	188.42
	1/2"	1.500"	.500"	---	---	14MPHR-R10050	146.51
	3/4"	1.688"	.750"	14MPHR-G10075	\$161.63	14MPHR-R10075	236.68
	1"	1.688"	1.000"	14MPHR-G100	36.42	14MPHR-R100	104.65
1 1/2"	1/2"	1.500"	.500"	14MPHR-G15050	71.08	14MPHR-R15050	139.84
	5/8"	1.500"	.625"	---	---	14MPHR-R150625	208.17
	3/4"	1.500"	.750"	14MPHR-G15075	71.08	14MPHR-R15075	139.84
	1"	1.687"	1.000"	14MPHR-G150100	76.25	14MPHR-R150100	141.01
	1 1/2"	1.689"	1.500"	14MPHR-G150	42.57	14MPHR-R150	110.66
2"	1 1/2"	2.312"	1.500"	14MPHR-G200150	141.83	14MPHR-R200150	223.90
	2"	2.312"	2.000"	14MPHR-G200	62.44	14MPHR-R200	149.69
2 1/2"	2 1/2"	2.344"	2.500"	14MPHR-G250	81.50	14MPHR-R250	69.26
3"	3"	3.094"	3.000"	14MPHR-G300	96.44	14MPHR-R300	268.61
4"	4"	3.406"	4.000"	14MPHR-G400	152.41	14MPHR-R400	120.71
6"	6"	3.406"	6.000"	14MPHR-G600	573.53	14MPHR-R600	168.65

Brewery Hose Barb Adapters - 14MPHRL

Feature:

- suitable for use with band clamps

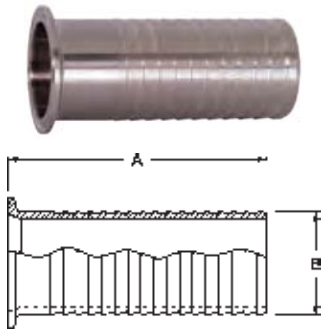

Tube OD	Dimensions		304 Stainless Steel	
	A	B	Part #	Price/E
1"	3.500"	1.045"	14MPHRL100	\$54.12
1 1/2"	5.000"	1.545"	14MPHRL150	66.60
2"	5.000"	2.045"	14MPHRL200	68.65
2 1/2"	5.500"	2.545"	14MPHRL250	79.81
3"	5.500"	3.045"	14MPHRL300	95.51
4"	5.500"	4.045"	14MPHRL400	152.54

Use of PVC tubing requires special installation techniques to prevent leakage. All assembly work must be done with heated tube. Cold durometer is 90 as opposed to rubber hose at 65 to 70 durometer. Banding buckles must be at 180° from one another. 

Clamp Fittings - Adapters

Male NPT Clamp Adapters - 21MP

Tube OD	NPT Size	Dimensions		304 Stainless Steel		316L Stainless Steel	
		A	B	Part #	Price/E	Part #	Price/E
1/2"	1/4"	2.000"	.595"	---	---	<b>21MP-R5025</b>	<b>\$79.96</b>
	3/8"	2.000"	.600"	---	---	<b>21MP-R50375</b>	<b>80.69</b>
	1/2"	1.625"	.782"	---	---	<b>21MP-R50</b>	<b>65.08</b>
	3/4"	2.000"	.794"	---	---	<b>21MP-R5075</b>	<b>81.04</b>
3/4"	1/4"	2.000"	.595"	---	---	<b>21MP-R7525</b>	<b>90.21</b>
	3/8"	2.000"	.600"	---	---	<b>21MP-R75375</b>	<b>46.99</b>
	1/2"	2.000"	.782"	---	---	<b>21MP-R7550</b>	<b>94.29</b>
	3/4"	1.787"	.794"	---	---	<b>21MP-R75</b>	<b>60.79</b>
1"	1/2"	2.187"	.782"	<b>21MP-G10050</b>	<b>\$125.80</b>	<b>21MP-R10050</b>	<b>135.50</b>
	3/4"	2.187"	.794"	<b>21MP-G10075</b>	<b>91.38</b>	<b>21MP-R10075</b>	<b>135.50</b>
	1"	2.250"	.985"	<b>21MP-G100</b>	<b>73.04</b>	<b>21MP-R100</b>	<b>97.28</b>
	1 1/4"	2.438"	1.009"	<b>21MP-G100125</b>	<b>67.98</b>	<b>21MP-R100125</b>	<b>196.20</b>
	1 1/2"	2.438"	1.025"	<b>21MP-G100150</b>	<b>73.67</b>	<b>21MP-R100150</b>	<b>115.00</b>
	2"	2.625"	1.058"	<b>21MP-G100200</b>	<b>122.48</b>	<b>21MP-R100200</b>	<b>136.66</b>
1 1/2"	3/8"	2.187"	.600"	<b>21MP-G150375</b>	<b>57.67</b>	<b>21MP-R150375</b>	<b>79.88</b>
	1/2"	2.187"	.782"	<b>21MP-G15050</b>	<b>127.59</b>	<b>21MP-R15050</b>	<b>137.07</b>
	3/4"	2.187"	.794"	<b>21MP-G15075</b>	<b>127.59</b>	<b>21MP-R15075</b>	<b>137.07</b>
	1"	2.437"	.985"	<b>21MP-G150100</b>	<b>91.03</b>	<b>21MP-R150100</b>	<b>101.01</b>
	1 1/4"	2.438"	1.009"	<b>21MP-G150125</b>	<b>130.04</b>	<b>21MP-R150125</b>	<b>172.50</b>
	1 1/2"	2.250"	1.025"	<b>21MP-G150</b>	<b>77.07</b>	<b>21MP-R150</b>	<b>96.52</b>
	2"	2.625"	1.058"	<b>21MP-G150200</b>	<b>183.43</b>	<b>21MP-R150200</b>	<b>133.14</b>
2"	1/2"	2.188"	.782"	<b>21MP-G20050</b>	<b>102.94</b>	<b>21MP-R20050</b>	<b>118.90</b>
	3/4"	2.188"	.794"	<b>21MP-G20075</b>	<b>102.94</b>	<b>21MP-R20075</b>	<b>118.90</b>
	1"	2.469"	.985"	<b>21MP-G200100</b>	<b>161.91</b>	<b>21MP-R200100</b>	<b>239.17</b>
	1 1/2"	2.625"	1.009"	<b>21MP-G200150</b>	<b>104.76</b>	<b>21MP-R200150</b>	<b>132.44</b>
	2"	2.638"	1.058"	<b>21MP-G200</b>	<b>96.03</b>	<b>21MP-R200</b>	<b>139.17</b>
2 1/2"	1/2"	2.781"	.782"	<b>21MP-G25050</b>	<b>675.15</b>	---	---
	1"	2.781"	.782"	<b>21MP-G250100</b>	<b>143.40</b>	<b>21MP-R250100</b>	<b>225.14</b>
	1 1/2"	2.781"	1.025"	<b>21MP-G250150</b>	<b>143.40</b>	<b>21MP-R250150</b>	<b>455.55</b>
	2"	2.781"	1.058"	<b>21MP-G250200</b>	<b>309.64</b>	<b>21MP-R250200</b>	<b>173.73</b>
	2 1/2"	2.875"	1.571"	<b>21MP-G250</b>	<b>154.82</b>	<b>21MP-R250</b>	<b>190.06</b>
3"	1 1/2"	3.000"	1.009"	<b>21MP-G300150</b>	<b>236.09</b>	<b>21MP-R300150</b>	<b>694.55</b>
	2"	3.000"	1.058"	<b>21MP-G300200</b>	<b>236.09</b>	<b>21MP-R300200</b>	<b>278.28</b>
	3"	3.070"	1.634"	<b>21MP-G300</b>	<b>184.82</b>	<b>21MP-R300</b>	<b>246.18</b>
4"	4"	3.155"	1.734"	<b>21MP-G400</b>	<b>244.87</b>	<b>21MP-R400</b>	<b>675.29</b>

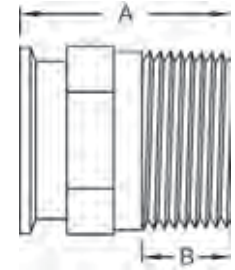



Clamp Fittings - Adapters

Female NPT Clamp Adapters - 22MP



Tube OD	NPT Size	Dimension A	304 Stainless Steel		316L Stainless Steel	
			Part #	Price/E	Part #	Price/E
1/2"	1/4"	1.500"	---	---	<b>22MP-R5025</b>	<b>\$66.49</b>
	3/8"	1.500"	---	---	<b>22MP-R50375</b>	<b>49.68</b>
	1/2"	1.500"	---	---	<b>22MP-R50</b>	<b>66.49</b>
	3/4"	1.500"	---	---	<b>22MP-R5075</b>	<b>56.85</b>
3/4"	1/4"	1.500"	---	---	<b>22MP-R7525</b>	<b>46.16</b>
	1/2"	1.625"	---	---	<b>22MP-R7550</b>	<b>74.80</b>
	3/4"	1.625"	---	---	<b>22MP-R75</b>	<b>60.31</b>
1"	1/4"	1.625"	---	---	<b>22MP-R10025</b>	<b>79.88</b>
	1/2"	1.625"	<b>22MP-G10050</b>	<b>\$62.11</b>	<b>22MP-R10050</b>	<b>215.98</b>
	3/4"	1.625"	<b>22MP-G10075</b>	<b>62.11</b>	<b>22MP-R10075</b>	<b>79.88</b>
	1"	1.625"	<b>22MP-G100</b>	<b>75.11</b>	<b>22MP-R100</b>	<b>97.28</b>
	1 1/4"	1.625"	---	---	<b>22MP-R100125</b>	<b>376.65</b>
1 1/2"	1/2"	1.625"	<b>22MP-G15050</b>	<b>62.11</b>	<b>22MP-R15050</b>	<b>215.98</b>
	3/4"	1.625"	<b>22MP-G15075</b>	<b>126.52</b>	<b>22MP-R15075</b>	<b>79.88</b>
	1"	2.250"	<b>22MP-G150100</b>	<b>76.47</b>	<b>22MP-R150100</b>	<b>88.30</b>
	1 1/2"	2.250"	<b>22MP-G150</b>	<b>82.30</b>	<b>22MP-R150</b>	<b>101.76</b>
	2"	2.500"	<b>22MP-G150200</b>	<b>97.64</b>	<b>22MP-R150200</b>	<b>217.95</b>
2"	1"	1.687"	<b>22MP-G200100</b>	<b>83.40</b>	<b>22MP-R200100</b>	<b>104.75</b>
	1 1/2"	2.344"	<b>22MP-G200150</b>	<b>100.32</b>	<b>22MP-R200150</b>	<b>85.20</b>
	2"	2.406"	<b>22MP-G200</b>	<b>94.28</b>	<b>22MP-R200</b>	<b>139.92</b>
	2 1/2"	2.406"	<b>22MP-G200250</b>	<b>333.93</b>	---	---
2 1/2"	2"	2.093"	<b>22MP-G250200</b>	<b>92.75</b>	<b>22MP-R250200</b>	<b>135.50</b>
	2 1/2"	2.187"	<b>22MP-G250</b>	<b>109.35</b>	<b>22MP-R250</b>	<b>240.00</b>
3"	2"	2.187"	<b>22MP-G300200</b>	<b>163.58</b>	<b>22MP-R300200</b>	<b>201.74</b>
	2 1/2"	2.187"	<b>22MP-G300250</b>	<b>136.60</b>	---	---
	3"	2.187"	<b>22MP-G300</b>	<b>168.43</b>	<b>22MP-R300</b>	<b>240.00</b>
4"	4"	3.652"	<b>22MP-G400</b>	<b>260.61</b>	<b>22MP-R400</b>	<b>254.93</b>

Visit [dixonvalve.com](http://dixonvalve.com) for pipe thread data

Clamp Fittings - Elbows

90° Clamp Elbows - B2CMP

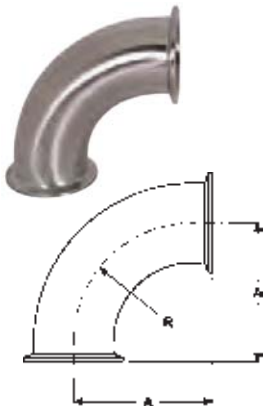

Tube OD	Dimensions		304 Stainless Steel		316L Stainless Steel	
	A	R	Part #	Price/E	Part #	Price/E
1/2"	1.625"	1.125"	---	---	<b>B2CMP-R50</b>	<b>\$78.06</b>
3/4"	1.625"	1.125"	---	---	<b>B2CMP-R75</b>	<b>81.84</b>
1"	2.000"	1.500"	<b>B2CMP-G100</b>	<b>\$40.76</b>	<b>B2CMP-R100</b>	<b>53.84</b>
1 1/2"	2.750"	2.250"	<b>B2CMP-G150</b>	<b>42.12</b>	<b>B2CMP-R150</b>	<b>56.33</b>
2"	3.500"	3.000"	<b>B2CMP-G200</b>	<b>56.40</b>	<b>B2CMP-R200</b>	<b>79.09</b>
2 1/2"	4.250"	3.750"	<b>B2CMP-G250</b>	<b>76.11</b>	<b>B2CMP-R250</b>	<b>107.48</b>
3"	5.000"	4.500"	<b>B2CMP-G300</b>	<b>97.16</b>	<b>B2CMP-R300</b>	<b>142.69</b>
4"	6.625"	6.000"	<b>B2CMP-G400</b>	<b>180.87</b>	<b>B2CMP-R400</b>	<b>222.37</b>
6"	9.875"	9.000"	<b>B2CMP-G600</b>	<b>480.56</b>	<b>B2CMP-R600</b>	<b>567.24</b>



Clamp Fittings - Elbows

45° Clamp Elbows - B2KMP

Tube OD	Dimensions		304 Stainless Steel		316L Stainless Steel	
	A	R	Part #	Price/E	Part #	Price/E
1/2"	.996"	1.125"	---	---	<b>B2KMP-R50</b>	<b>\$89.66</b>
3/4"	.966"	1.125"	---	---	<b>B2KMP-R75</b>	<b>90.46</b>
1"	1.125"	1.500"	<b>B2KMP-G100</b>	<b>\$37.06</b>	<b>B2KMP-R100</b>	<b>50.74</b>
1 1/2"	1.437"	2.250"	<b>B2KMP-G150</b>	<b>40.76</b>	<b>B2KMP-R150</b>	<b>56.17</b>
2"	1.750"	3.000"	<b>B2KMP-G200</b>	<b>55.59</b>	<b>B2KMP-R200</b>	<b>70.13</b>
2 1/2"	2.062"	3.750"	<b>B2KMP-G250</b>	<b>74.12</b>	<b>B2KMP-R250</b>	<b>107.63</b>
3"	2.375"	4.500"	<b>B2KMP-G300</b>	<b>101.11</b>	<b>B2KMP-R300</b>	<b>133.17</b>
4"	3.125"	6.000"	<b>B2KMP-G400</b>	<b>160.83</b>	<b>B2KMP-R400</b>	<b>195.70</b>
6"	4.625"	9.000"	<b>B2KMP-G600</b>	<b>486.21</b>	<b>B2KMP-R600</b>	<b>1037.65</b>



Pipe, Welding & Tube Fittings

90° Clamp x Plain Bevel Seat with Hex Nut Elbows - B2FMP-14

Tube OD	Dimensions		304 Stainless Steel	
	A	B	Part #	Price/E
2"	3.750"	3.500"	<b>B2FMP-14-G200</b>	<b>\$238.27</b>
2 1/2"	4.625"	4.250"	<b>B2FMP-14-G250</b>	<b>285.09</b>
3"	5.406"	5.000"	<b>B2FMP-14-G300</b>	<b>388.84</b>



Clamp Fittings - Tees

Short Outlet Clamp Tees - B7MPS

Pipe, Welding & Tube Fittings

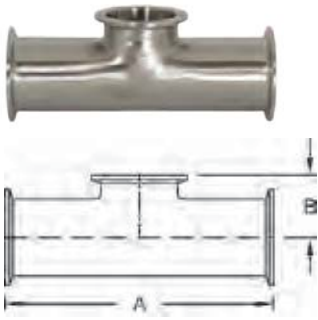

Tube OD	Dimensions		316L Stainless Steel	
	A	B	Part #	Price/E
1½"	5.500"	1.375"	<b>B7MPS-R150</b>	<b>\$284.29</b>
2"	7.000"	1.625"	<b>B7MPS-R200</b>	<b>311.96</b>
2½"	7.000"	1.875"	<b>B7MPS-R250</b>	<b>340.13</b>

Clamp Tees - B7MP

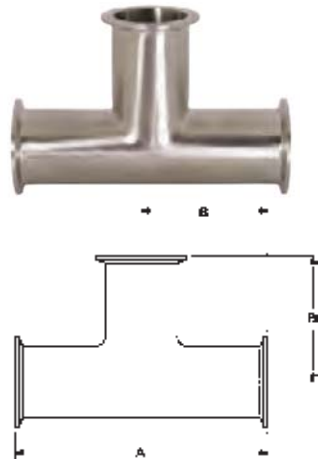

Tube OD	Dimensions		304 Stainless Steel		316L Stainless Steel	
	A	B	Part #	Price/E	Part #	Price/E
½"	4.750"	2.375"	---	---	<b>B7MP-R50</b>	<b>\$135.07</b>
¾"	5.000"	2.500"	---	---	<b>B7MP-R75</b>	<b>133.71</b>
1"	4.750"	2.375"	<b>B7MP-G100</b>	<b>\$75.01</b>	<b>B7MP-R100</b>	<b>84.76</b>
1½"	5.500"	2.750"	<b>B7MP-G150</b>	<b>79.91</b>	<b>B7MP-R150</b>	<b>104.19</b>
2"	7.000"	3.500"	<b>B7MP-G200</b>	<b>88.33</b>	<b>B7MP-R200</b>	<b>122.31</b>
2½"	7.000"	3.500"	<b>B7MP-G250</b>	<b>120.08</b>	<b>B7MP-R250</b>	<b>169.88</b>
3"	7.500"	3.750"	<b>B7MP-G300</b>	<b>166.04</b>	<b>B7MP-R300</b>	<b>235.56</b>
4"	9.000"	4.500"	<b>B7MP-G400</b>	<b>248.01</b>	<b>B7MP-R400</b>	<b>307.69</b>
6"	13.000"	6.500"	<b>B7MP-G600</b>	<b>1223.08</b>	<b>B7MP-R600</b>	<b>1528.85</b>
8"	15.750"	7.875"	<b>B7MP-G800</b>	<b>1993.16</b>	<b>B7MP-R800</b>	<b>2747.26</b>

Clamp Reducing Tees - B7RMP

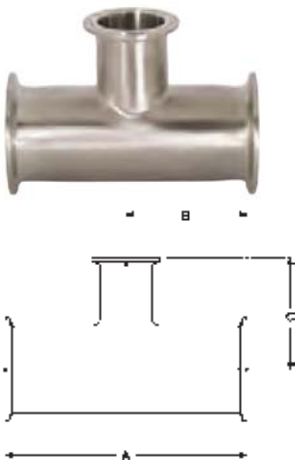

Tube OD	Dimensions			304 Stainless Steel		316L Stainless Steel	
	A	B	C	Part #	Price/E	Part #	Price/E
1" x ¾"	5.250"	2.625"	2.625"	---	---	<b>B7RMP-R10075</b>	<b>\$119.74</b>
1½" x ½"	5.750"	2.875"	2.875"	---	---	<b>B7RMP-R15050</b>	<b>128.36</b>
1½" x 1"	4.312"	2.156"	1.875"	---	---	<b>B7RMP-R150100</b>	<b>185.90</b>
2" x ½"	6.750"	3.375"	3.125"	---	---	<b>B7RMP-R20050</b>	<b>670.44</b>
2" x ¾"	6.750"	3.375"	3.125"	---	---	<b>B7RMP-R20075</b>	<b>723.99</b>
2" x 1"	5.125"	2.562"	2.125"	<b>B7RMP-G200100</b>	<b>\$158.42</b>	<b>B7RMP-R200100</b>	<b>173.56</b>
2" x 1½"	5.125"	2.562"	2.406"	<b>B7RMP-G200150</b>	<b>158.42</b>	<b>B7RMP-R200150</b>	<b>173.56</b>
2½" x 1½"	5.688"	2.844"	2.812"	<b>B7RMP-G250150</b>	<b>195.70</b>	<b>B7RMP-R250150</b>	<b>241.12</b>
2½" x 2"	5.688"	2.844"	2.812"	<b>B7RMP-G250200</b>	<b>195.70</b>	<b>B7RMP-R250200</b>	<b>241.12</b>
3" x 1½"	6.188"	3.093"	2.906"	<b>B7RMP-G300150</b>	<b>271.41</b>	<b>B7RMP-R300150</b>	<b>422.36</b>
3" x 2"	6.188"	3.093"	3.063"	<b>B7RMP-G300200</b>	<b>212.00</b>	<b>B7RMP-R300200</b>	<b>301.69</b>
4" x 1½"	8.125"	4.063"	3.406"	<b>B7RMP-G400150</b>	<b>343.37</b>	---	---
4" x 2"	8.125"	4.063"	3.563"	<b>B7RMP-G400200</b>	<b>387.32</b>	---	---

Clamp Fittings - Reducers

3

Clamp Concentric Reducers - B3114MP

Tube OD	Dimension A	304 Stainless Steel		316L Stainless Steel	
		Part #	Price/E	Part #	Price/E
1" x 1/2"	3.000"	---	---	<b>B3114MP-R10050</b>	<b>\$172.86</b>
1" x 3/4"	2.000"	---	---	<b>B3114MP-R10075</b>	<b>146.77</b>
1 1/2" x 1/2"	5.000"	---	---	<b>B3114MP-R15050</b>	<b>220.16</b>
1 1/2" x 3/4"	4.000"	---	---	<b>B3114MP-R15075</b>	<b>171.24</b>
1 1/2" x 1"	3.000"	<b>B3114MP-G150100</b>	<b>\$69.31</b>	<b>B3114MP-R150100</b>	<b>77.47</b>
2" x 3/4"	6.000"	---	---	<b>B3114MP-R20075</b>	<b>228.30</b>
2" x 1"	5.000"	<b>B3114MP-G200100</b>	<b>88.95</b>	<b>B3114MP-R200100</b>	<b>98.67</b>
2" x 1 1/2"	3.000"	<b>B3114MP-G200150</b>	<b>73.39</b>	<b>B3114MP-R200150</b>	<b>81.55</b>
2 1/2" x 1 1/2"	5.000"	<b>B3114MP-G250150</b>	<b>100.00</b>	<b>B3114MP-R250150</b>	<b>111.19</b>
2 1/2" x 2"	3.000"	<b>B3114MP-G250200</b>	<b>91.33</b>	<b>B3114MP-R250200</b>	<b>101.93</b>
3" x 1 1/2"	7.000"	<b>B3114MP-G300150</b>	<b>163.08</b>	<b>B3114MP-R300150</b>	<b>194.78</b>
3" x 2"	5.000"	<b>B3114MP-G300200</b>	<b>116.38</b>	<b>B3114MP-R300200</b>	<b>138.61</b>
3" x 2 1/2"	3.000"	<b>B3114MP-G300250</b>	<b>110.07</b>	<b>B3114MP-R300250</b>	<b>122.31</b>
4" x 1 1/2"	11.125"	<b>B3114MP-G400150</b>	<b>320.34</b>	<b>B3114MP-R400150</b>	<b>497.39</b>
4" x 2"	9.125"	<b>B3114MP-G400200</b>	<b>217.44</b>	<b>B3114MP-R400200</b>	<b>275.20</b>
4" x 2 1/2"	7.125"	<b>B3114MP-G400250</b>	<b>262.09</b>	<b>B3114MP-R400250</b>	<b>265.00</b>
4" x 3"	5.125"	<b>B3114MP-G400300</b>	<b>144.55</b>	<b>B3114MP-R400300</b>	<b>163.08</b>
6" x 4"	7.000"	<b>B3114MP-G600400</b>	<b>623.07</b>	---	---

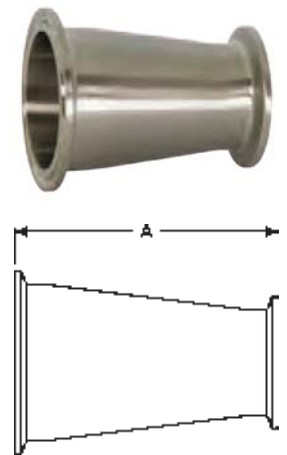

Pipe, Welding & Tube Fittings

Clamp Eccentric Reducers - B3214MP

Tube OD	Dimension A	304 Stainless Steel		316L Stainless Steel	
		Part #	Price/E	Part #	Price/E
1 1/2" x 1"	3.000"	<b>B3214MP-G150100</b>	<b>\$78.27</b>	<b>B3214MP-R150100</b>	<b>\$71.96</b>
2" x 1"	5.000"	<b>B3214MP-G200100</b>	<b>159.59</b>	<b>B3214MP-R200100</b>	<b>231.56</b>
2" x 1 1/2"	3.000"	<b>B3214MP-G200150</b>	<b>83.33</b>	<b>B3214MP-R200150</b>	<b>99.65</b>
2 1/2" x 1 1/2"	5.000"	<b>B3214MP-G250150</b>	<b>122.31</b>	<b>B3214MP-R250150</b>	<b>140.43</b>
2 1/2" x 2"	3.000"	<b>B3214MP-G250200</b>	<b>98.59</b>	<b>B3214MP-R250200</b>	<b>100.14</b>
3" x 1 1/2"	7.000"	<b>B3214MP-G300150</b>	<b>199.32</b>	<b>B3214MP-R300150</b>	<b>203.84</b>
3" x 2"	5.000"	<b>B3214MP-G300200</b>	<b>141.02</b>	<b>B3214MP-R300200</b>	<b>163.08</b>
3" x 2 1/2"	3.000"	<b>B3214MP-G300250</b>	<b>166.14</b>	<b>B3214MP-R300250</b>	<b>168.17</b>
4" x 2"	9.125"	<b>B3214MP-G400200</b>	<b>305.77</b>	<b>B3214MP-R400200</b>	<b>280.85</b>
4" x 2 1/2"	7.125"	<b>B3214MP-G400250</b>	<b>253.68</b>	<b>B3214MP-R400250</b>	<b>258.21</b>
4" x 3"	5.125"	<b>B3214MP-G400300</b>	<b>187.54</b>	<b>B3214MP-R400300</b>	<b>244.62</b>
6" x 3"	6.875"	<b>B3214MP-G600300</b>	<b>931.88</b>	---	---
6" x 4"	7.000"	<b>B3214MP-G600400</b>	<b>1076.49</b>	---	---

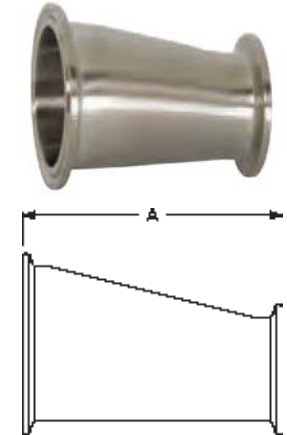

Clamp Crosses

3

Clamp Crosses - B9MP

Tube OD	Dimensions		304 Stainless Steel		316L Stainless Steel	
	A	B	Part #	Price/E	Part #	Price/E
1"	4.750"	2.375"	<b>B9MP-G100</b>	<b>\$220.16</b>	<b>B9MP-R100</b>	<b>\$252.77</b>
1 1/2"	5.500"	2.750"	<b>B9MP-G150</b>	<b>224.55</b>	<b>B9MP-R150</b>	<b>265.81</b>
2"	7.000"	3.500"	<b>B9MP-G200</b>	<b>227.14</b>	<b>B9MP-R200</b>	<b>362.03</b>
3"	7.500"	3.750"	<b>B9MP-G300</b>	<b>396.05</b>	<b>B9MP-R300</b>	<b>652.30</b>
4"	9.000"	4.500"	<b>B9MP-G400</b>	<b>936.54</b>	<b>B9MP-R400</b>	<b>1147.96</b>

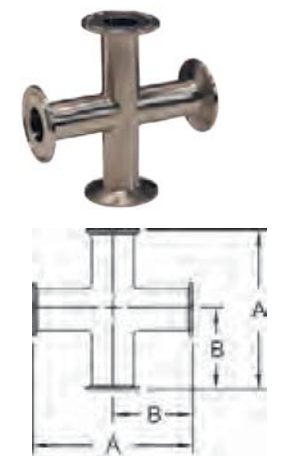

Miscellaneous Configurations

Clamp Laterals - B28AMP

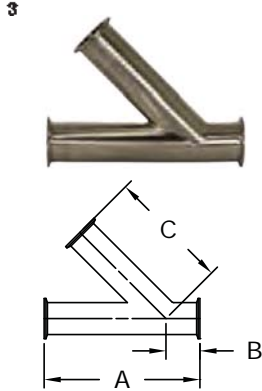

Tube OD	Dimensions			316L Stainless Steel	
	A	B	C	Part #	Price/E
1"	7.000"	1.500"	5.500"	<b>B28AMP-R100</b>	<b>\$472.93</b>
1½"	8.375"	1.688"	6.688"	<b>B28AMP-R150</b>	<b>521.85</b>
2"	9.750"	2.125"	7.625"	<b>B28AMP-R200</b>	<b>524.18</b>
3"	11.750"	2.375"	9.375"	<b>B28AMP-R300</b>	<b>792.08</b>
4"	14.062"	2.640"	11.312"	<b>B28AMP-R400</b>	<b>1728.61</b>

Clamp True Wyes - B28BMP

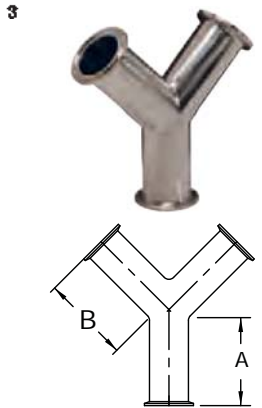

Tube OD	Dimensions		316L Stainless Steel	
	A	B	Part #	Price/E
1"	2.500"	2.938"	<b>B28BMP-R100</b>	<b>\$489.23</b>
1½"	2.500"	2.938"	<b>B28BMP-R150</b>	<b>538.15</b>
2"	3.125"	3.750"	<b>B28BMP-R200</b>	<b>524.18</b>
3"	4.500"	5.375"	<b>B28BMP-R300</b>	<b>886.74</b>
4"	6.000"	6.000"	<b>B28BMP-R400</b>	<b>1281.33</b>

Clamp 180° Return Bends - B2WUMP

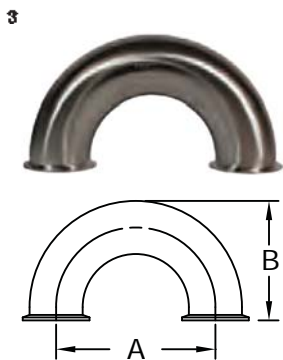

- Feature:**
- bends are the standard 1.5 x tube diameter

Tube OD	Dimensions		316L Stainless Steel	
	A	B	Part #	Price/E
1"	3.000"	2.500"	<b>B2WUMP-R100</b>	<b>\$206.77</b>
1½"	4.500"	3.500"	<b>B2WUMP-R150</b>	<b>277.23</b>
2"	6.000"	4.500"	<b>B2WUMP-R200</b>	<b>363.46</b>
3"	9.000"	6.500"	<b>B2WUMP-R300</b>	<b>646.16</b>
4"	12.000"	8.625"	<b>B2WUMP-R400</b>	<b>738.45</b>

Clamp End Protection Covers - BCC

- Feature:**
- Use these covers to protect all clamp ends on fittings, valves, filters and pumps.



Size	Vinyl Plastic	
	Part #	Price/E
½"	<b>BCC-050</b>	<b>\$0.95</b>
¾"	<b>BCC-075</b>	<b>0.95</b>
1"	<b>BCC-100</b>	<b>1.43</b>
1½"	<b>BCC-150</b>	<b>1.43</b>
2"	<b>BCC-200</b>	<b>2.13</b>
2½"	<b>BCC-250</b>	<b>2.49</b>
3"	<b>BCC-300</b>	<b>3.33</b>
4"	<b>BCC-400</b>	<b>4.75</b>
6"	<b>BCC-600</b>	<b>16.61</b>
8"	<b>BCC-800</b>	<b>28.25</b>

Quick Weld Ferrules

**Features:**

- just slip onto sanitary OD tube and weld
- butt weld is not needed



Pipe, Welding  
& Tube Fittings

Tube OD	Dimensions			304 Stainless Steel	
	A	B	C	Part #	Price/E
1"	.290"	1.005"	.870"	<b>14QMP-G100</b>	<b>\$9.85</b>
1½"	.199"	1.505"	1.370"	<b>14QMP-G150</b>	<b>9.85</b>
2"	.205"	2.005"	1.870"	<b>14QMP-G200</b>	<b>12.53</b>
2½"	.210"	2.505"	2.370"	<b>14QMP-G250</b>	<b>15.07</b>
3"	.257"	3.005"	2.870"	<b>14QMP-G300</b>	<b>18.92</b>
4"	.235"	4.005"	3.834"	<b>14QMP-G400</b>	<b>28.85</b>
6"	.321"	6.005"	5.782"	<b>14QMP-G600</b>	<b>74.16</b>

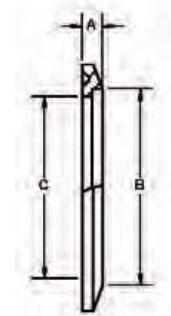

Breakaway Coupling - Clamp

**Applications:**

- Minimizes spillage and damage associated with pull away and drive away incidents

**Features:**

- designed to be installed between a fixed point and a hose
- coupling breaks away with an excessive load
- EPDM standard clamp gasket
- working pressure: **350 PSI @ 70°F (21°C)**
- 3kN break load bolts standard, other break loads available
- 316 stainless steel polished to standard <math>32R\_a</math>, 3A finish
- other sizes, gaskets and connections available, contact Dixon®



Size	316 Stainless Steel	
	Part #	Price/E
3"	<b>SBC-E300CC13</b>	<b>\$718.60</b>



Clamp Gaskets

Features:

- materials approved by 3 (3A), and USDA and comply with FDA's 21CFR177.2600 and 1550
- PSI service ratings for the sanitary clamps DO NOT APPLY to connections (1" and above) using any PTFE gaskets, due to the potential for cold flow under normal operating conditions
- PTFE gaskets, when used with any clamp, are likely to leak at pressures far below the published service ratings. This restriction does not apply to the fractionally sized 1/2" and 3/4" connections, due to their recessed, fully contained design.

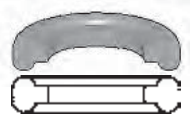

Mini



Standard - type 1



Flanged - type 2

Buna-N Clamp Gaskets - Black

Features:

- color code: red dot
- meets 21CFR 177.2600



Size	Part #	Buna-N	Price/E
1/2"	42MP-U50		\$1.85
3/4"	42MP-U75		2.47
1"	40MP-U100		0.77
1 1/2"	40MP-U150		0.57
2"	40MP-U200		0.64
2 1/2"	40MP-U250		0.97
3"	40MP-U300		1.10
4"	40MP-U400		1.74
5"	40MP-U500		7.44
6"	40MP-U600		9.22
8"	40MP-U800		9.75

Buna-N Clamp Gaskets - White

Features:

- color code: red dot
- meets 21CFR 177.2600



Size	Part #	Buna-N	Price/E
1/2"	42MP-UW50		\$2.41
3/4"	42MP-UW75		2.69
1"	40MP-UW100		1.28
1 1/2"	40MP-UW150		1.15
2"	40MP-UW200		1.03
2 1/2"	40MP-UW250		1.41
3"	40MP-UW300		1.54
4"	40MP-UW400		2.51
6"	40MP-UW600		17.43

EPDM Clamp Gaskets - Black

Features:

- color code: three green dots
- peroxide cured
- meets 21CFR 177.2600
- passed USP Class VI Cytotoxicity testing



Size	Part #	EPDM	Price/E
1/2"	42MP-E50		\$1.74
3/4"	42MP-E75		1.74
1"	40MP-E100		1.03
1 1/2"	40MP-E150		1.15
2"	40MP-E200		1.15
2 1/2"	40MP-E250		1.47
3"	40MP-E300		1.61
4"	40MP-E400		2.11
6"	40MP-E600		10.45

Visit [dixonvalve.com](http://dixonvalve.com) for sizing charts



## Clamp Gaskets

## FKM Clamp Gaskets - Black

## Features:

- color code: one white dot, one yellow dot
- peroxide cured
- meets 21CFR 177.2600
- passed USP Class VI Cytotoxicity testing

Size	FKM	
	Part #	Price/E
1/2"	42MP-SFY50	\$5.47
3/4"	42MP-SFY75	6.24
1"	40MP-SFY100	6.29
1 1/2"	40MP-SFY150	4.36
2"	40MP-SFY200	4.54
2 1/2"	40MP-SFY250	8.45
3"	40MP-SFY300	11.16
4"	40MP-SFY400	15.39
6"	40MP-SFY600	53.84

Pipe, Welding  
& Tube Fittings

## Silicone Clamp Gaskets - White

## Features:

- color code: pink dot
- peroxide cured
- meets 21CFR 177.2600
- passed USP Class VI Cytotoxicity testing

Size	Silicone	
	Part #	Price/E
1/2"	42MP-XW50	\$2.87
3/4"	42MP-XW75	3.23
1"	40MP-XW100	3.08
1 1/2"	40MP-XW150	2.56
2"	40MP-XW200	3.00
2 1/2"	40MP-XW250	4.31
3"	40MP-XW300	4.62
4"	40MP-XW400	5.31
6"	40MP-XW600	38.14



## Silicone Clamp Gaskets - Clear

## Features:

- color code: no dot
- peroxide cured
- meets 21CFR 177.2600

Size	Silicone	
	Part #	Price/E
1/2"	42MP-XC50	\$2.82
3/4"	42MP-XC75	3.39
1"	40MP-XC100	3.64
1 1/2"	40MP-XC150	4.28
2"	40MP-XC200	3.64
2 1/2"	40MP-XC250	5.06
3"	40MP-XC300	5.41
4"	40MP-XC400	6.47

Visit [dixonvalve.com](http://dixonvalve.com) for sizing charts

Clamp Gaskets

PTFE Clamp Gaskets - White

Features:

- color code: no dot
- meets 21CFR 177.1550
- passed USP Class VI Cytotoxicity testing
- not recommended for use with bolted clamps

Pipe, Welding & Tube Fittings



Size	Part #	PTFE	Price/E
1/2"	42MP-G50		\$1.77
3/4"	42MP-G75		1.80
1"	40MP-G100		2.23
1 1/2"	40MP-G150		1.97
2"	40MP-G200		2.38
2 1/2"	40MP-G250		3.08
3"	40MP-G300		3.15
4"	40MP-G400		6.39
5"	40MP-G500		65.39
6"	40MP-G600		40.63
8"	40MP-G800		42.94
10"	40MP-G1000		60.62
12"	40MP-G1200		255.19

PTFE is a material subject to plastic flow. When cycled through heat and then cooled down in process lines, PTFE gaskets will not return to the original configuration and it will continue to compress as the cycling continues. This plastic flow will allow leakage if clamp torques are not maintained.



Buna-N Flanged Clamp Gaskets - Black

Features:

- color code: red dot
- meets 21CFR 177.2600
- not recommended for use with bolted clamps



Size	Part #	Buna-N	Price/E
1"	40MPF-U100		\$2.03
1 1/2"	40MPF-U150		1.67
2"	40MPF-U200		2.03
2 1/2"	40MPF-U250		2.44
3"	40MPF-U300		3.36
4"	40MPF-U400		4.54
6"	40MPF-U600		25.56
8"	40MPF-U800		22.22
10"	40MPF-U1000		36.83
12"	40MPF-U1200		59.49

Buna-N Flanged Clamp Gaskets - White

Features:

- color code: red dot
- meets 21CFR 177.2600
- not recommended for use with bolted clamps



Size	Part #	Buna-N	Price/E
1"	40MPF-UW100		\$3.01
1 1/2"	40MPF-UW150		2.31
2"	40MPF-UW200		2.65
2 1/2"	40MPF-UW250		4.75
3"	40MPF-UW300		4.75
4"	40MPF-UW400		6.78
6"	40MPF-UW600		58.74

Visit [dixonvalve.com](http://dixonvalve.com) for sizing charts



## Clamp Gaskets

## EPDM Flanged Clamp Gaskets - Black

## Features:

- color code: three green dots
- peroxide cured
- meets 21CFR 177.2600
- passed USP Class VI Cytotoxicity testing
- not recommended for use with bolted clamps

Size	EPDM	
	Part #	Price/E
1"	40MPF-E100	\$3.28
1½"	40MPF-E150	3.28
2"	40MPF-E200	3.85
2½"	40MPF-E250	5.33
3"	40MPF-E300	6.28
4"	40MPF-E400	6.80
6"	40MPF-E600	42.31
8"	40MPF-E800	62.51
10"	40MPF-E1000	76.99
12"	40MPF-E1200	86.28

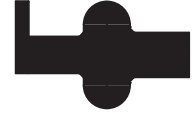

## FKM Flanged Clamp Gaskets - Black

## Features:

- color code: one white dot, one yellow dot
- peroxide cured
- meets 21CFR 177.2600
- passed USP Class VI Cytotoxicity testing
- not recommended for use with bolted clamps

Size	FKM	
	Part #	Price/E
1"	40MPF-SFY100	\$11.40
1½"	40MPF-SFY150	8.21
2"	40MPF-SFY200	9.81
2½"	40MPF-SFY250	16.42
3"	40MPF-SFY300	18.60
4"	40MPF-SFY400	20.01
6"	40MPF-SFY600	64.80
8"	40MPF-SFY800	100.00
10"	40MPF-SFY1000	130.57
12"	40MPF-SFY1200	168.65

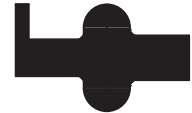

## Silicone Flanged Clamp Gaskets - White

## Features:

- color code: pink dot
- peroxide cured
- meets 21CFR 177.2600
- passed USP Class VI Cytotoxicity testing
- not recommended for use with bolted clamps

Size	Silicone	
	Part #	Price/E
1"	40MPF-XW100	\$5.06
1½"	40MPF-XW150	4.75
2"	40MPF-XW200	4.62
2½"	40MPF-XW250	6.23
3"	40MPF-XW300	7.24
4"	40MPF-XW400	9.88
6"	40MPF-XW600	51.28
8"	40MPF-XW800	60.90
10"	40MPF-XW1000	65.70
12"	40MPF-XW1200	70.52

Visit [dixonvalve.com](http://dixonvalve.com) for sizing charts

## Clamp Gaskets

## Buna-N Mesh Screen Clamp Gasket, 316

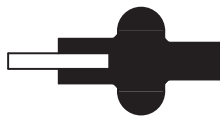

Type 3 - Mesh

**Features:**

- color code: red dot
- meets 21CFR 177.2600
- 10 mesh standard, other mesh available-call for details

Size	Buna-N	
	Part #	Price/E
1"	<b>40MPS-U100</b>	<b>\$52.30</b>
1½"	<b>40MPS-U150</b>	<b>41.96</b>
2"	<b>40MPS-U200</b>	<b>42.67</b>
2½"	<b>40MPS-U250</b>	<b>57.69</b>
3"	<b>40MPS-U300</b>	<b>65.39</b>
4"	<b>40MPS-U400</b>	<b>100.96</b>

## PTFE Envelope Clamp Gaskets with EPDM Filler

**Features:**

- color code: usually not marked
- peroxide cured EPDM
- meets 21CFR 177.1550
- PTFE passed USP Class VI Cytotoxicity testing

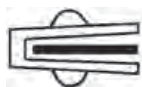

Size	PTFE with EPDM Filler	
	Part #	Price/E
½"	<b>42MP-GRE50</b>	<b>\$17.06</b>
1"	<b>40MP-GRE100</b>	<b>9.42</b>
1½"	<b>40MP-GRE150</b>	<b>8.01</b>
2"	<b>40MP-GRE200</b>	<b>7.11</b>
2½"	<b>40MP-GRE250</b>	<b>10.83</b>
3"	<b>40MP-GRE300</b>	<b>10.67</b>
4"	<b>40MP-GRE400</b>	<b>22.56</b>
6"	<b>40MP-GRE600</b>	<b>71.22</b>

## PTFE Envelope Clamp Gaskets with FKM Filler

**Features:**

- color code: FKM usually not marked
- peroxide cured FKM
- meets 21CFR 177.1550
- PTFE passed USP Class VI Cytotoxicity testing

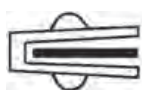

Size	PTFE with FKM Filler	
	Part #	Price/E
1"	<b>40MP-GR100</b>	<b>\$9.16</b>
1½"	<b>40MP-GR150</b>	<b>8.01</b>
2"	<b>40MP-GR200</b>	<b>9.68</b>
2½"	<b>40MP-GR250</b>	<b>10.26</b>
3"	<b>40MP-GR300</b>	<b>11.73</b>
4"	<b>40MP-GR400</b>	<b>21.99</b>
6"	<b>40MP-GR600</b>	<b>74.75</b>

PTFE is a material subject to plastic flow. When cycled through heat and then cooled down in process lines, PTFE gaskets will not return to the original configuration and it will continue to compress as the cycling continues. This plastic flow will allow leakage if clamp torques are not maintained.



Visit [dixonvalve.com](http://dixonvalve.com) for sizing charts

## Metal Detectable Clamp Gaskets

**Feature:**

- impregnated with stainless steel particles allowing a gasket or gasket pieces to be found with metal detection equipment

**Buna-N Metal Detectable Clamp Gaskets****Features:**

- good general use where temperature extremes do not exist
- minimum temperature: **-20°F (-29°C)**
- maximum temperature: **212°F (100°C)**

Size	Buna-N	
	Part #	Price/E
1"	<b>40MP-UZ100</b>	<b>\$3.64</b>
1½"	<b>40MP-UZ150</b>	<b>3.52</b>
2"	<b>40MP-UZ200</b>	<b>3.59</b>
2½"	<b>40MP-UZ250</b>	<b>5.85</b>
3"	<b>40MP-UZ300</b>	<b>6.46</b>
4"	<b>40MP-UZ400</b>	<b>7.05</b>

**EPDM Metal Detectable Clamp Gaskets****Features:**

- resistant to steam, water and base solutions
- minimum temperature: **-70°F (-57°C)**
- maximum temperature: **310°F (154°C)**

Size	EPDM	
	Part #	Price/E
1"	<b>40MP-EZ100</b>	<b>\$5.08</b>
1½"	<b>40MP-EZ150</b>	<b>4.92</b>
2"	<b>40MP-EZ200</b>	<b>5.16</b>
2½"	<b>40MP-EZ250</b>	<b>6.77</b>
3"	<b>40MP-EZ300</b>	<b>7.13</b>
4"	<b>40MP-EZ400</b>	<b>9.93</b>

**FKM Metal Detectable Clamp Gaskets****Features:**

- resistant to steam, heat and high acid solutions
- minimum temperature: **-20°F (-29°C)**
- maximum temperature: **410°F (410°C)**

Size	FKM	
	Part #	Price/E
1"	<b>40MP-SFYZ100</b>	<b>\$11.40</b>
1½"	<b>40MP-SFYZ150</b>	<b>11.53</b>
2"	<b>40MP-SFYZ200</b>	<b>9.85</b>
2½"	<b>40MP-SFYZ250</b>	<b>19.37</b>
3"	<b>40MP-SFYZ300</b>	<b>20.38</b>
4"	<b>40MP-SFYZ400</b>	<b>31.28</b>



Cam and Groove Transition Fittings <sup>1</sup>

## Cam and Groove Adapter x Clamp End



Size	316 Stainless Steel	
	Part #	Price/E
1½"	<b>RE150SE</b>	<b>\$162.75</b>
2"	<b>RE200SE</b>	<b>180.00</b>
3"	<b>RE300SE</b>	<b>378.00</b>

## Cam and Groove Coupler x Clamp End



Size	316 Stainless Steel	
	Part #	Price/E
1½"	<b>RC150SE</b>	<b>\$270.00</b>
2"	<b>RC200SE</b>	<b>310.50</b>
3"	<b>RC300SE</b>	<b>490.00</b>

Dixon® Weld to Tube Cam and Groove <sup>1</sup>

## Features:

- designed to be welded to standard sanitary tubing
- 316 stainless steel investment casting

## Cam and Groove Adapter x Weld to Tube End



Size	316 Stainless Steel	
	Part #	Price/E
1"	<b>RE100BT</b>	<b>\$130.00</b>
1½"	<b>RE150BT</b>	<b>147.30</b>
2"	<b>RE200BT</b>	<b>169.15</b>
3"	<b>RE300BT</b>	<b>357.00</b>

## Boss-Lock™ Coupler x Weld to Tube End



Size	316 Stainless Steel	
	Part #	Price/E
1"	<b>RC100BT</b>	<b>\$195.00</b>
1½"	<b>RC150BT</b>	<b>240.00</b>
2"	<b>RC200BT</b>	<b>260.00</b>
3"	<b>RC300BT</b>	<b>425.00</b>

<sup>1</sup> for all other cam and groove options see section D



European Fittings

DIN 11851 Round Nuts - 13R

Tube OD	DN Size	Dimensions			304 Stainless Steel	
		A	B	C	Part #	Price/E
1"	25	.83"	2.48"	2.05"	<b>13R-G100DIN</b>	<b>\$34.56</b>
1½"	40	.83"	3.07"	2.43"	<b>13R-G150DIN</b>	<b>43.08</b>
2"	50	.87"	3.62"	3.07"	<b>13R-G200DIN</b>	<b>55.10</b>
2½"	65	.98"	4.41"	3.74"	<b>13R-G250DIN</b>	<b>74.66</b>
3"	80	1.14"	5.00"	4.33"	<b>13R-G300DIN</b>	<b>114.69</b>
4"	100	1.22"	5.83"	5.12"	<b>13R-G400DIN</b>	<b>133.81</b>

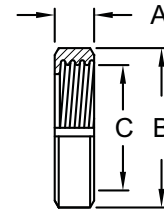

Pipe, Welding & Tube Fittings

DIN Blank Caps - 16AMP

Tube OD	DN Size	Dimensions				316 Stainless Steel	
		A	B	C	D	Part #	Price/E
1"	25	.51"	1.73"	.39"	1.38"	<b>16AMP-R100DIN</b>	<b>\$28.17</b>
1½"	40	.51"	2.20"	.39"	1.89"	<b>16AMP-R150DIN</b>	<b>44.70</b>
2"	50	.55"	2.68"	.43"	2.40"	<b>16AMP-R200DIN</b>	<b>63.72</b>
2½"	65	.63"	3.39"	.47"	3.11"	<b>16AMP-R250DIN</b>	<b>112.99</b>
3"	80	.63"	3.94"	.47"	3.66"	<b>16AMP-R300DIN</b>	<b>139.37</b>
4"	100	.79"	4.76"	.59"	4.49"	<b>16AMP-R400DIN</b>	<b>231.99</b>

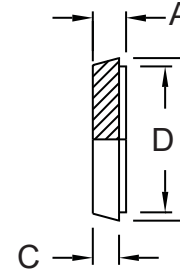

DIN Welding Males - 15A

Tube OD	DN Size	Dimensions		316 Stainless Steel	
		A	B	Part #	Price/E
1"	25	1.14"	2.04"	<b>15A-R100DIN</b>	<b>\$32.67</b>
1½"	40	1.30"	2.55"	<b>15A-R150DIN</b>	<b>45.50</b>
2"	50	1.38"	3.07"	<b>15A-R200DIN</b>	<b>55.53</b>
2½"	65	1.57"	3.74"	<b>15A-R250DIN</b>	<b>88.31</b>
3"	80	1.77"	4.31"	<b>15A-R300DIN</b>	<b>135.09</b>
4"	100	2.13"	5.12"	<b>15A-R400DIN</b>	<b>155.08</b>

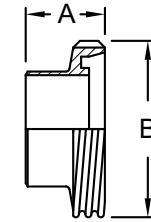

DIN Welding Liners - 14A

Tube OD	DN Size	Dimensions		316 Stainless Steel	
		A	B	Part #	Price/E
1"	25	.87"	1.73"	<b>14A-R100DIN</b>	<b>\$22.71</b>
1½"	40	1.02"	2.20"	<b>14A-R150DIN</b>	<b>31.95</b>
2"	50	1.10"	2.68"	<b>14A-R200DIN</b>	<b>40.83</b>
2½"	65	1.26"	3.39"	<b>14A-R250DIN</b>	<b>70.18</b>
3"	80	1.46"	3.94"	<b>14A-R300DIN</b>	<b>97.55</b>
4"	100	1.73"	4.76"	<b>14A-R400DIN</b>	<b>124.29</b>

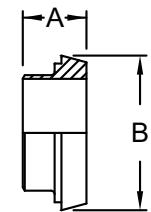

DIN Buna-N European Gaskets - Black

Features:

- color code: red dot
- meets 21CFR 177.2600

Tube OD	DN Size	ID	OD	Height	DIN 11851 Buna-N	
					Part #	Price/E
1"	25	1.18"	1.57"	.20"	<b>40MP-U100DIN</b>	<b>\$1.82</b>
1½"	40	1.65"	2.05"	.20"	<b>40MP-U150DIN</b>	<b>2.31</b>
2"	50	2.13"	2.52"	.20"	<b>40MP-U200DIN</b>	<b>2.80</b>
2½"	65	2.80"	3.19"	.20"	<b>40MP-U250DIN</b>	<b>3.62</b>
3"	80	3.35"	3.74"	.20"	<b>40MP-U300DIN</b>	<b>4.28</b>
4"	100	4.09"	4.49"	.24"	<b>40MP-U400DIN</b>	<b>5.93</b>

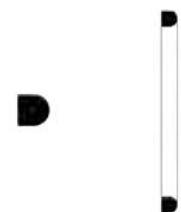

## European Fittings SMS

### SMS Round Nuts - 13R

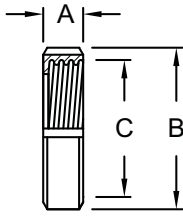

Tube OD	DN Size	Dimensions			304 Stainless Steel	
		A	B	C	Part #	Price/E
1"	25.0	.75"	2.01"	1.57"	<b>13R-G100SMS</b>	<b>\$22.53</b>
1½"	38.0	.91"	2.91"	2.36"	<b>13R-G150SMS</b>	<b>33.92</b>
2"	51.0	.94"	3.31"	2.76"	<b>13R-G200SMS</b>	<b>40.45</b>
2½"	63.5	1.10"	3.94"	3.35"	<b>13R-G250SMS</b>	<b>56.84</b>
3"	76.0	1.18"	4.49"	3.86"	<b>13R-G300SMS</b>	<b>71.40</b>
4"	101.6	1.22"	5.43"	4.92"	<b>13R-G400SMS</b>	<b>80.33</b>

### SMS Blank Caps - 16AMP

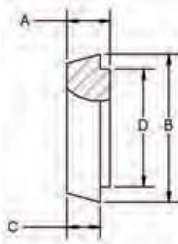

Tube OD	DN Size	Dimensions				316 Stainless Steel	
		A	B	C	D	Part #	Price/E
1"	25	.30"	1.40"	.14"	1.25"	<b>16AMP-R100SMS</b>	<b>\$14.63</b>
1½"	38	.31"	2.20"	.16"	1.89"	<b>16AMP-R150SMS</b>	<b>24.97</b>
2"	51	.35"	2.56"	.16"	2.38"	<b>16AMP-R200SMS</b>	<b>36.34</b>
2½"	63.5	.35"	3.15"	.16"	2.89"	<b>16AMP-R250SMS</b>	<b>52.23</b>
3"	76	.43"	3.66"	.20"	3.41"	<b>16AMP-R300SMS</b>	<b>85.90</b>
4"	101.6	.43"	4.65"	.23"	4.43"	<b>16AMP-R400SMS</b>	<b>110.51</b>

### SMS Welding Males - 15A

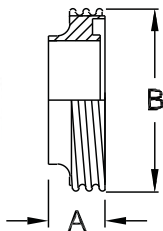

Tube OD	DN Size	Dimensions		316 Stainless Steel	
		A	B	Part #	Price/E
1"	25.0	.75"	1.57"	<b>15A-R100SMS</b>	<b>\$16.63</b>
1½"	38.0	.91"	2.36"	<b>15A-R150SMS</b>	<b>33.28</b>
2"	51.0	.91"	2.76"	<b>15A-R200SMS</b>	<b>45.06</b>
2½"	63.5	1.06"	3.35"	<b>15A-R250SMS</b>	<b>62.02</b>
3"	76.0	1.06"	3.86"	<b>15A-R300SMS</b>	<b>71.62</b>
4"	101.6	1.18"	4.92"	<b>15A-R400SMS</b>	<b>104.11</b>

### SMS Welding Liners - 14A

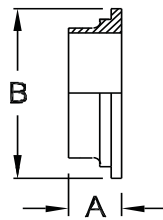

Tube OD	DN Size	Dimensions		316 Stainless Steel	
		A	B	Part #	Price/E
1"	25	.61"	1.40"	<b>14A-R100SMS</b>	<b>\$10.94</b>
1½"	38	.63"	2.17"	<b>14A-R150SMS</b>	<b>15.43</b>
2"	51	.67"	2.56"	<b>14A-R200SMS</b>	<b>19.22</b>
2½"	63.5	.67"	3.16"	<b>14A-R250SMS</b>	<b>25.04</b>
3"	76	.75"	3.66"	<b>14A-R300SMS</b>	<b>34.36</b>
4"	101.6	.75"	4.65"	<b>14A-R400SMS</b>	<b>45.06</b>

### SMS Buna-N European Gaskets - Black

**Features:**

- color code: red dot
- meets 21CFR 177.2600



Tube OD	DN Size	ID	OD	L Style Buna-N	
				Part #	Price/E
1"	25	.98"	1.26"	<b>40MP-U100SMS</b>	<b>\$1.23</b>
1½"	38	1.49"	1.89"	<b>40MP-U150SMS</b>	<b>2.31</b>
2"	51	2.00"	2.40"	<b>40MP-U200SMS</b>	<b>2.41</b>
2½"	63.5	2.50"	2.89"	<b>40MP-U250SMS</b>	<b>2.69</b>
3"	76	2.99"	3.39"	<b>40MP-U300SMS</b>	<b>4.75</b>
4"	101.6	4.09"	4.49"	<b>40MP-U400SMS</b>	<b>7.59</b>

European Fittings

RJT BS: 4825

RJT Hex Nuts - 13H

Tube OD	Dimensions		304 Stainless Steel	
	A	B	Part #	Price/E
1"	.87"	2.00"	<b>13H-G100RJT</b>	<b>\$24.68</b>
1½"	.87"	2.56"	<b>13H-G150RJT</b>	<b>33.11</b>
2"	.87"	3.12"	<b>13H-G200RJT</b>	<b>43.08</b>
2½"	.87"	3.62"	<b>13H-G250RJT</b>	<b>53.84</b>
3"	.87"	4.12"	<b>13H-G300RJT</b>	<b>62.11</b>
4"	.87"	5.12"	<b>13H-G400RJT</b>	<b>81.30</b>

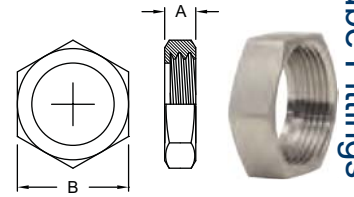

Pipe, Welding & Tube Fittings

RJT Blank Caps - 13RBN

Tube OD	Dimensions		304 Stainless Steel	
	A	B	Part #	Price/E
1"	.32"	1.63"	<b>13RBN-G100RJT</b>	<b>\$14.03</b>
1½"	.32"	2.12"	<b>13RBN-G150RJT</b>	<b>20.04</b>
2"	.32"	2.62"	<b>13RBN-G200RJT</b>	<b>32.85</b>
2½"	.32"	3.12"	<b>13RBN-G250RJT</b>	<b>38.13</b>
3"	.32"	3.63"	<b>13RBN-G300RJT</b>	<b>64.62</b>
4"	.32"	4.63"	<b>13RBN-G400RJT</b>	<b>56.38</b>

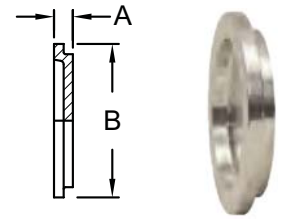

RJT Welding Males - 15A

Tube OD	Dimension		316 Stainless Steel	
	A	B	Part #	Price/E
1"	1.06"	1.80"	<b>15A-R100RJT</b>	<b>\$31.05</b>
1½"	1.06"	2.30"	<b>15A-R150RJT</b>	<b>40.39</b>
2"	1.06"	2.86"	<b>15A-R200RJT</b>	<b>52.68</b>
2½"	1.06"	3.36"	<b>15A-R250RJT</b>	<b>61.66</b>
3"	1.06"	3.86"	<b>15A-R300RJT</b>	<b>62.59</b>
4"	1.06"	4.86"	<b>15A-R400RJT</b>	<b>105.99</b>

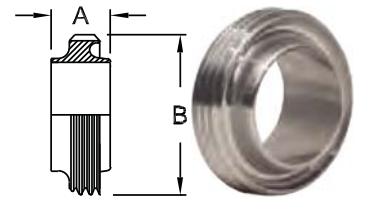

RJT Welding Liners - 14A

Tube OD	Dimensions		316 Stainless Steel	
	A	B	Part #	Price/E
1"	.77"	1.63"	<b>14A-R100RJT</b>	<b>\$19.87</b>
1½"	.77"	2.13"	<b>14A-R150RJT</b>	<b>22.53</b>
2"	.77"	2.63"	<b>14A-R200RJT</b>	<b>28.54</b>
2½"	.77"	3.13"	<b>14A-R250RJT</b>	<b>38.95</b>
3"	.77"	3.63"	<b>14A-R300RJT</b>	<b>37.00</b>
4"	.77"	4.63"	<b>14A-R400RJT</b>	<b>66.72</b>

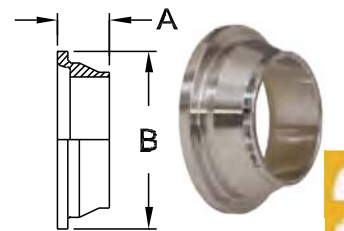

RJT Spanner Wrenches - SP

Tube OD	Dimensions		Aluminum	
	A	B	Part #	Price/E
1"	10.00"	2.00"	<b>RJT-100SP</b>	<b>\$99.34</b>
1½"	11.50"	2.56"	<b>RJT-150SP</b>	<b>102.90</b>
2"	12.00"	3.12"	<b>RJT-200SP</b>	<b>126.16</b>
2½"	13.50"	3.62"	<b>RJT-250SP</b>	<b>169.61</b>
3"	14.50"	4.12"	<b>RJT-300SP</b>	<b>235.37</b>
4"	17.50"	5.12"	<b>RJT-400SP</b>	<b>214.03</b>

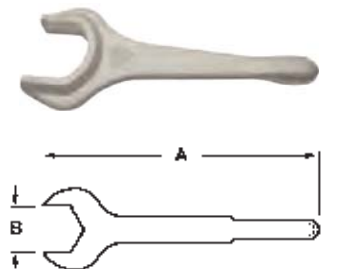

European Fittings

RJT Buna-N European Gaskets - Black

Pipe, Welding  
& Tube Fittings



Features:

- color code: red dot
- meets 21CFR 177.2600

Tube OD	ID	Diameter	Buna-N	
			Part #	Price/E
1"	1.06"	.25"	<b>40MP-U100RJT</b>	<b>\$2.15</b>
1½"	1.56"	.25"	<b>40MP-U150RJT</b>	<b>2.64</b>
2"	2.06"	.25"	<b>40MP-U200RJT</b>	<b>3.62</b>
2½"	2.56"	.25"	<b>40MP-U250RJT</b>	<b>4.28</b>
3"	3.06"	.25"	<b>40MP-U300RJT</b>	<b>4.60</b>
4"	4.06"	.25"	<b>40MP-U400RJT</b>	<b>6.91</b>

DIN and SMS Spanner Wrenches - SP

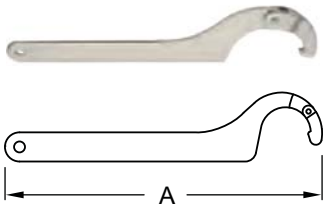

Used On	DN Size	Dimension A	Nickel Plated Steel	
			Part #	Price/E
1" - 1½"	25-40	9.75"	<b>DIN-SMS-60/90SP</b>	<b>\$223.29</b>
2" - 4"	50-101.6	13.00"	<b>DIN-SMS90/155SP</b>	<b>591.67</b>



Bevel Seat Union Hex Nuts - 13H

Feature:

- maximum operating pressure: **400 PSI**

Tube OD	Dimensions		304 Stainless Steel (CF8)	Price/E
	A	B	Part #	
1"	.906"	1.812"	<b>13H-G100</b>	<b>\$17.17</b>
1½"	.968"	2.406"	<b>13H-G150</b>	<b>26.17</b>
2"	1.062"	3.000"	<b>13H-G200</b>	<b>29.89</b>
2½"	1.187"	3.594"	<b>13H-G250</b>	<b>47.50</b>
3"	1.281"	4.188"	<b>13H-G300</b>	<b>51.61</b>
4"	1.500"	5.438"	<b>13H-G400</b>	<b>101.19</b>

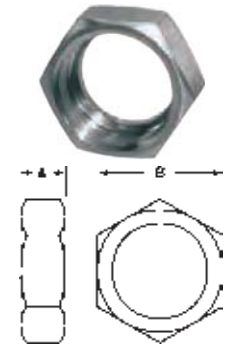

Pipe, Welding  
& Tube Fittings

Bevel Seat Hex Wrenches

Single Sided Hex Wrenches - 25H

Tube OD	Dimensions		Aluminum	Price/E
	A	B	Part #	
1"	10.500"	1.812"	<b>25H-100</b>	<b>\$49.68</b>
1½"	12.000"	2.406"	<b>25H-150</b>	<b>51.45</b>
2"	14.000"	3.000"	<b>25H-200</b>	<b>63.08</b>
2½"	16.250"	3.594"	<b>25H-250</b>	<b>94.23</b>
3"	18.500"	4.188"	<b>25H-300</b>	<b>130.75</b>
4"	19.500"	5.438"	<b>25H-400</b>	<b>166.47</b>

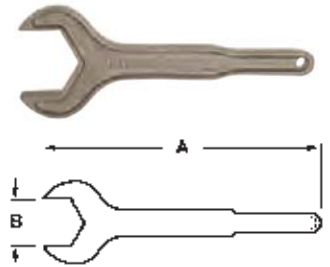

Two Sided Hex Wrenches - 25H

Tube OD	Dimensions			Aluminum	Price/E
	A	B	C	Part #	
1½" x 1"	12.000"	2.406"	1.812"	<b>25H-150100</b>	<b>\$93.13</b>
2" x 1½"	14.000"	3.000"	2.406"	<b>25H-200150</b>	<b>103.86</b>
2½" x 2"	16.500"	3.594"	3.000"	<b>25H-250200</b>	<b>125.44</b>
3" x 2"	18.000"	4.188"	3.000"	<b>25H-300200</b>	<b>154.62</b>
3" x 2½"	18.000"	4.188"	3.594"	<b>25H-300250</b>	<b>167.02</b>

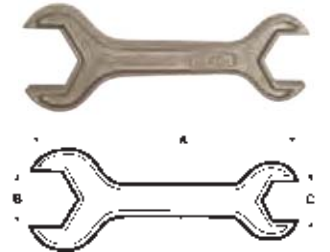

Bevel Seat Ferrules

Pipe, Welding & Tube Fittings

3

Short Plain Bevel Seat Weld Ferrules - 14PRF

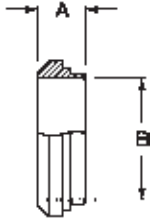

Tube OD	Dimensions		304 Stainless Steel	
	A	B	Part #	Price/E
1"	.718"	.870"	<b>14PRF-G100</b>	<b>\$8.96</b>
1½"	.718"	1.370"	<b>14PRF-G150</b>	<b>11.21</b>
2"	.750"	1.870"	<b>14PRF-G200</b>	<b>13.04</b>
2½"	.875"	2.370"	<b>14PRF-G250</b>	<b>22.82</b>
3"	.906"	2.870"	<b>14PRF-G300</b>	<b>27.05</b>
4"	1.031"	3.834"	<b>14PRF-G400</b>	<b>47.37</b>

3

Long Plain Bevel Seat Weld Ferrules - 14A

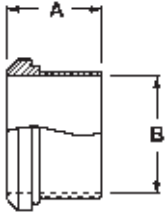

Tube OD	Dimensions		304 Stainless Steel	
	A	B	Part #	Price/E
1"	1.375"	.870"	<b>14A-G100</b>	<b>\$13.22</b>
1½"	1.500"	1.370"	<b>14A-G150</b>	<b>15.34</b>
2"	1.500"	1.870"	<b>14A-G200</b>	<b>17.53</b>
2½"	1.750"	2.370"	<b>14A-G250</b>	<b>28.35</b>
3"	1.750"	2.870"	<b>14A-G300</b>	<b>38.19</b>
4"	1.750"	3.834"	<b>14A-G400</b>	<b>60.85</b>

3<sup>1</sup>

Recessless Plain Bevel Seat Ferrules for Expanding - 14R

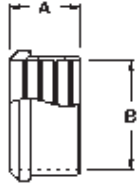

Tube OD	Dimensions		304 Stainless Steel	
	A	B	Part #	Price/E
1½"	1.125"	1.505"	<b>14R-G150</b>	<b>\$17.17</b>
2"	1.312"	2.005"	<b>14R-G200</b>	<b>22.37</b>
2½"	1.375"	2.505"	<b>14R-G250</b>	<b>29.84</b>
3"	1.437"	3.005"	<b>14R-G300</b>	<b>37.80</b>
4"	1.500"	4.005"	<b>14R-G400</b>	<b>61.33</b>

<sup>1</sup> Meets 3-A Standard Number 63-03 when used to modify or repair existing on-site farm milk handling systems.

3

Short Threaded Bevel Seat Weld Ferrules - 15TRF

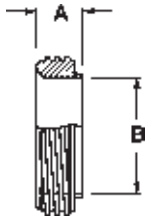

Tube OD	Dimensions		304 Stainless Steel	
	A	B	Part #	Price/E
1"	.718"	.870"	<b>15TRF-G100</b>	<b>\$12.16</b>
1½"	.718"	1.370"	<b>15TRF-G150</b>	<b>12.70</b>
2"	.750"	1.870"	<b>15TRF-G200</b>	<b>17.61</b>
2½"	.875"	2.370"	<b>15TRF-G250</b>	<b>25.66</b>
3"	.906"	2.870"	<b>15TRF-G300</b>	<b>34.00</b>
4"	1.031"	3.834"	<b>15TRF-G400</b>	<b>54.97</b>



Bevel Seat Ferrules

Long Threaded Bevel Seat Weld Ferrules - 15A

Tube OD	Dimensions		304 Stainless Steel	
	A	B	Part #	Price/E
1"	1.375"	.870"	<b>15A-G100</b>	<b>\$18.43</b>
1½"	1.500"	1.370"	<b>15A-G150</b>	<b>24.99</b>
2"	1.500"	1.870"	<b>15A-G200</b>	<b>30.57</b>
2½"	1.750"	2.370"	<b>15A-G250</b>	<b>44.47</b>
3"	1.750"	2.870"	<b>15A-G300</b>	<b>58.41</b>
4"	1.750"	3.834"	<b>15A-G400</b>	<b>87.74</b>



Pipe, Welding & Tube Fittings

Recessless Threaded Bevel Seat Ferrules for Expanding - 15R

Tube OD	Dimensions		304 Stainless Steel	
	A	B	Part #	Price/E
1	.812"	1.005"	<b>15R-G100</b>	<b>\$20.89</b>
1½"	1.125"	1.505"	<b>15R-G150</b>	<b>24.13</b>
2"	1.375"	2.005"	<b>15R-G200</b>	<b>31.51</b>
2½"	1.500"	2.505"	<b>15R-G250</b>	<b>55.66</b>
3"	1.625"	3.005"	<b>15R-G300</b>	<b>49.81</b>
4"	1.675"	4.005"	<b>15R-G400</b>	<b>79.24</b>

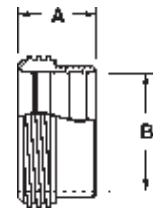

<sup>1</sup> Meets 3-A Standard Number 63-03 when used to modify or repair existing on-site farm milk handling systems.

Bevel Seat End Caps

Plain Bevel Seat Solid End Caps - 16A

Tube OD	Dimension A	304 Stainless Steel	
	A	Part #	Price/E
1"	1.312"	<b>16A-G100</b>	<b>\$8.42</b>
1½"	1.843"	<b>16A-G150</b>	<b>13.60</b>
2"	2.375"	<b>16A-G200</b>	<b>20.07</b>
2½"	2.906"	<b>16A-G250</b>	<b>27.12</b>
3"	3.437"	<b>16A-G300</b>	<b>40.88</b>
4"	4.500"	<b>16A-G400</b>	<b>71.36</b>



Bevel Seat Adapters

Plain Bevel Seat x Male NPT Adapters with Hex Nut - 14-19

Tube OD	Dimension A	304 Stainless Steel	
	A	Part #	Price/E
1½"	3.250"	<b>14-19-G150</b>	<b>\$219.29</b>
2"	3.312"	<b>14-19-G200</b>	<b>207.12</b>
3"	4.250"	<b>14-19-G300</b>	<b>338.54</b>

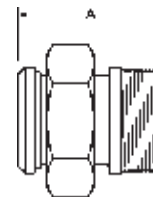

Bevel Seat Elbows



Threaded Bevel Seat x Plain Bevel Seat with Hex Nut 90° Elbows - B2F

Tube OD	Dimension A	304 Stainless Steel	
		Part #	Price/E
1½"	2.968"	<b>B2F-G150</b>	<b>\$170.50</b>
2"	3.750"	<b>B2F-G200</b>	<b>194.73</b>
2½"	4.625"	<b>B2F-G250</b>	<b>244.95</b>
3"	5.406"	<b>B2F-G300</b>	<b>308.03</b>

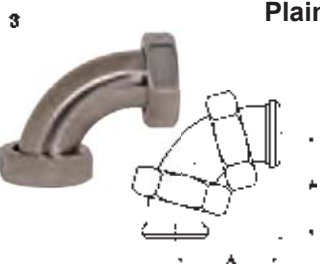

Plain Bevel Seat x Plain Bevel Seat with Hex Nut 90° Elbows - B2E

Tube OD	Dimension A	304 Stainless Steel	
		Part #	Price/E
1½"	2.968"	<b>B2E-G150</b>	<b>\$241.67</b>
2"	3.750"	<b>B2E-G200</b>	<b>287.81</b>
2½"	4.625"	<b>B2E-G250</b>	<b>269.69</b>
3"	5.406"	<b>B2E-G300</b>	<b>354.56</b>

Bevel Seat Reducers

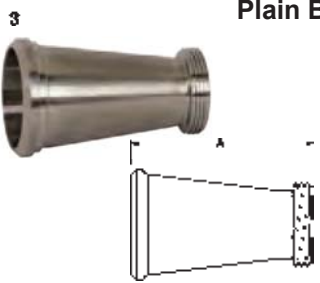

Plain Bevel Seat x Threaded Bevel Seat Concentric Reducers - B3115F

Tube OD	Dimension A	304 Stainless Steel	
		Part #	Price/E
2" x 1½"	3.468"	<b>B3115F-G200150</b>	<b>\$169.20</b>
2½" x 2"	3.625"	<b>B3115F-G250200</b>	<b>168.93</b>
3" x 2"	5.656"	<b>B3115F-G300200</b>	<b>225.39</b>
3" x 2½"	3.781"	<b>B3115F-G300250</b>	<b>195.73</b>
4" x 3"	5.937"	<b>B3115F-G400300</b>	<b>303.53</b>

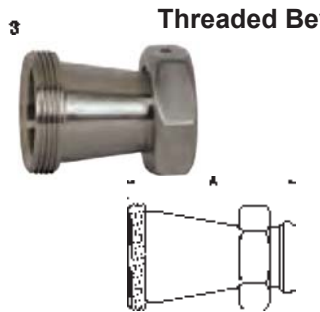

Threaded Bevel Seat x Plain Bevel Seat with Hex Nut Concentric Reducers - B31TP

Tube OD	Dimension A	304 Stainless Steel	
		Part #	Price/E
2" x 1½"	3.468"	<b>B31TP-G200150</b>	<b>\$194.65</b>
2½" x 2"	3.625"	<b>B31TP-G250200</b>	<b>219.16</b>
3" x 2"	5.656"	<b>B31TP-G300200</b>	<b>264.12</b>
3" x 2½"	3.781"	<b>B31TP-G300250</b>	<b>214.56</b>
4" x 3"	5.937"	<b>B31TP-G400300</b>	<b>381.09</b>

Breakaway Coupling - Bevel Seat

Applications:

- minimizes spillage and damage associated with pull away and drive away incidents

Features:

- designed to be installed between a fixed point and a hose
- coupling breaks away with an excessive load
- bevel seat connection standard
- EPDM standard clamp gasket
- working pressure: **350 PSI @ 70°F (21°C)**
- 13kN break load bolts standard, other break loads available
- 316 stainless steel polished to standard <math><32R\_a</math>, 3A finish
- other sizes, gaskets and connections available, contact Dixon®
- other connection styles available



Size	316 Stainless Steel	
	Part #	Price/E
3"	<b>SBC-E300TP13</b>	<b>\$878.38</b>

## Bevel Seat Gaskets

## Buna-N Bevel Seat Gaskets - Black

## Features:

- color code: red dot
- meets 21CFR 177.2600

Size	Buna-N	
	Part #	Price/E
1"	40BS-O100	\$1.74
1½"	40BS-O150	1.28
2"	40BS-O200	1.28
2½"	40BS-O250	2.44
3"	40BS-O300	3.01
4"	40BS-O400	5.33

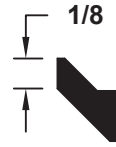

## PTFE Bevel Seat Gaskets - White

## Features:

- color code: no dot
- meets 21CFR 177.1550
- passed USP Class VI Cytotoxicity testing

Size	PTFE	
	Part #	Price/E
1"	40BS-S100	\$3.77
1½"	40BS-S150	3.00
2"	40BS-S200	3.59
2½"	40BS-S250	4.54
3"	40BS-S300	5.73
4"	40BS-S400	11.39

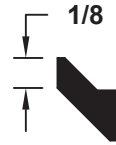

## Heavy PTFE Bevel Seat Gaskets - White

## Features:

- color code: no dot
- meets 21CFR 177.1550
- passed USP Class VI Cytotoxicity testing

Size	PTFE	
	Part #	Price/E
1"	40BS-H100	\$3.96
1½"	40BS-H150	5.26
2"	40BS-H200	5.39
2½"	40BS-H250	9.42
3"	40BS-H300	8.52
4"	40BS-H400	15.39

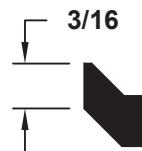

PTFE is a material subject to plastic flow. When cycled through heat and then cooled down in process lines, PTFE gaskets will not return to the original configuration and it will continue to compress as the cycling continues. This plastic flow will allow leakage if clamp torques are not maintained.



Visit [dixonvalve.com](http://dixonvalve.com) for sizing charts

I-Line / Q-Line Clamps

Heavy Duty Clamps - 13ILH



Tube OD	Service Pressure PSI Rating @ 70°F (21°C) <sup>1</sup>	Service Pressure PSI Rating @ 250°F (121°C) <sup>1</sup>	Dimension A	304 Stainless Steel	
				Part #	Price/E
1" - 1½"	<b>700</b>	<b>250</b>	2.122"	<b>13ILH100-150</b>	<b>\$27.54</b>
2"	<b>450</b>	<b>250</b>	2.654"	<b>13ILH200</b>	<b>33.83</b>
2½"	<b>450</b>	<b>200</b>	3.185"	<b>13ILH250</b>	<b>47.60</b>
3"	<b>350</b>	<b>150</b>	3.717"	<b>13ILH300</b>	<b>57.10</b>
4"	<b>200</b>	<b>125</b>	4.820"	<b>13ILH400</b>	<b>67.18</b>
6"	<b>150</b>	<b>100</b>	7.689"	<b>13ILH600</b>	<b>141.56</b>
8"	<b>125</b>	<b>75</b>	9.689"	<b>13ILH800</b>	<b>184.23</b>

<sup>1</sup> wing nut tightened to 25 in. lbs. of torque

Bolted Clamps - 13ILB

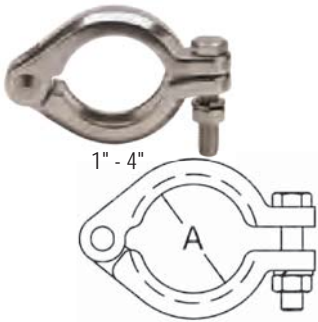

Tube OD	Service Pressure PSI Rating @ 70°F (21°C) <sup>1</sup>	Service Pressure PSI Rating @ 250°F (121°C) <sup>1</sup>	Dimension A	304 Stainless Steel	
				Part #	Price/E
1" - 1½"	<b>1220</b>	<b>1100</b>	2.122"	<b>13ILB100-150</b>	<b>\$31.62</b>
2"	<b>900</b>	<b>830</b>	2.654"	<b>13ILB200</b>	<b>53.50</b>
2½"	<b>720</b>	<b>660</b>	3.185"	<b>13ILB250</b>	<b>75.04</b>
3"	<b>600</b>	<b>550</b>	3.717"	<b>13ILB300</b>	<b>105.99</b>
4"	<b>570</b>	<b>525</b>	4.820"	<b>13ILB400</b>	<b>128.05</b>

<sup>1</sup> nut tightened to 20 ft. lbs. of torque

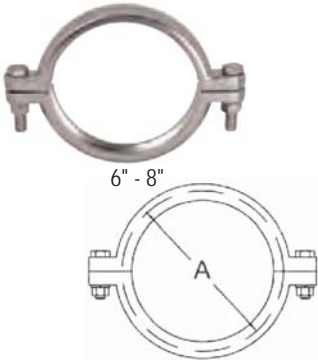

Tube OD	Service Pressure PSI Rating @ 70°F (21°C) <sup>1</sup>	Service Pressure PSI Rating @ 250°F (121°C) <sup>1</sup>	Dimension A	304 Stainless Steel	
				Part #	Price/E
6"	<b>300</b>	<b>200</b>	7.689"	<b>13ILB600</b>	<b>\$197.84</b>
8"	<b>250</b>	<b>150</b>	9.689"	<b>13ILB800</b>	<b>397.20</b>

<sup>1</sup> nut tightened to 20 ft. lbs. of torque

Q-Line Clamps

Heavy Duty Clamps - 13QLH<sup>1</sup>

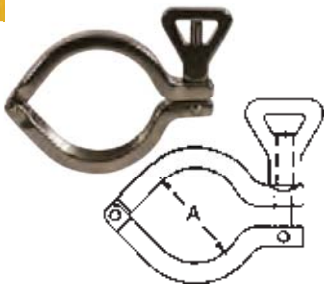

Tube OD	Dimension A	304 Stainless Steel	
		Part #	Price/E
1" - 1½"	2.122"	<b>13QLH100-150</b>	<b>\$27.54</b>
2"	2.654"	<b>13QLH200</b>	<b>33.83</b>
2½"	3.185"	<b>13QLH250</b>	<b>47.60</b>
3"	3.717"	<b>13QLH300</b>	<b>57.10</b>
4"	4.820"	<b>13QLH400</b>	<b>67.18</b>

<sup>1</sup> wing nut tightened to 25 in. lbs. of torque

Ferrules

Male I-Line Short Weld Ferrules - 14WI

Tube OD	Dimension A	304 Stainless Steel		316L Stainless Steel	
		Part #	Price/E	Part #	Price/E
1"	.600"	<b>14WI-G100</b>	<b>\$14.35</b>	<b>14WI-R100</b>	<b>\$18.35</b>
1½"	.765"	<b>14WI-G150</b>	<b>14.35</b>	<b>14WI-R150</b>	<b>18.35</b>
2"	.790"	<b>14WI-G200</b>	<b>20.89</b>	<b>14WI-R200</b>	<b>25.97</b>
2½"	.848"	<b>14WI-G250</b>	<b>31.69</b>	<b>14WI-R250</b>	<b>41.54</b>
3"	.906"	<b>14WI-G300</b>	<b>45.89</b>	<b>14WI-R300</b>	<b>59.74</b>
4"	1.031"	<b>14WI-G400</b>	<b>71.94</b>	<b>14WI-R400</b>	<b>94.31</b>
6"	.940"	---	---	<b>14WI-R600</b>	<b>345.76</b>
8"	.940"	---	---	<b>14WI-R800</b>	<b>551.77</b>

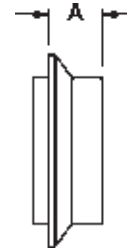

3  
Pipe, Welding  
& Tube Fittings

Male I-Line Long Weld Ferrules - 14WLI

Tube OD	Dimension A	304 Stainless Steel		316L Stainless Steel	
		Part #	Price/E	Part #	Price/E
1"	1.562"	<b>14WLI-G100</b>	<b>\$42.21</b>	<b>14WLI-R100</b>	<b>\$52.63</b>
1½"	1.843"	<b>14WLI-G150</b>	<b>42.73</b>	<b>14WLI-R150</b>	<b>143.45</b>
2"	2.062"	<b>14WLI-G200</b>	<b>51.64</b>	<b>14WLI-R200</b>	<b>230.78</b>
2½"	2.188"	<b>14WLI-G250</b>	<b>77.60</b>	<b>14WLI-R250</b>	<b>210.13</b>
3"	2.375"	<b>14WLI-G300</b>	<b>102.81</b>	<b>14WLI-R300</b>	<b>345.47</b>
4"	2.688"	<b>14WLI-G400</b>	<b>140.20</b>	<b>14WLI-R400</b>	<b>168.75</b>
6"	2.688"	---	---	<b>14WLI-R600</b>	<b>1877.51</b>

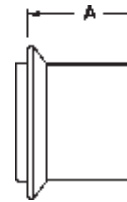

3

Female I-line Short Weld Ferrules - 15WI

Tube OD	Dimension A	304 Stainless Steel		316L Stainless Steel	
		Part #	Price/E	Part #	Price/E
1"	.785"	<b>15WI-G100</b>	<b>\$14.84</b>	<b>15WI-R100</b>	<b>\$18.69</b>
1½"	.950"	<b>15WI-G150</b>	<b>14.84</b>	<b>15WI-R150</b>	<b>18.69</b>
2"	1.040"	<b>15WI-G200</b>	<b>23.51</b>	<b>15WI-R200</b>	<b>29.23</b>
2½"	1.160"	<b>15WI-G250</b>	<b>33.59</b>	<b>15WI-R250</b>	<b>49.19</b>
3"	1.220"	<b>15WI-G300</b>	<b>46.78</b>	<b>15WI-R300</b>	<b>60.71</b>
4"	1.350"	<b>15WI-G400</b>	<b>73.19</b>	<b>15WI-R400</b>	<b>95.54</b>
6"	1.125"	---	---	<b>15WI-R600</b>	<b>345.76</b>
8"	1.125"	---	---	<b>15WI-R800</b>	<b>505.78</b>



3

Female I-Line Long Weld Ferrules - 15WLI

Tube OD	Dimension A	304 Stainless Steel		316L Stainless Steel	
		Part #	Price/E	Part #	Price/E
1"	1.750"	<b>15WLI-G100</b>	<b>\$42.21</b>	<b>15WLI-R100</b>	<b>\$63.14</b>
1½"	2.031"	<b>15WLI-G150</b>	<b>42.73</b>	<b>15WLI-R150</b>	<b>74.19</b>
2"	2.312"	<b>15WLI-G200</b>	<b>52.14</b>	<b>15WLI-R200</b>	<b>226.03</b>
2½"	2.500"	<b>15WLI-G250</b>	<b>71.13</b>	<b>15WLI-R250</b>	<b>350.63</b>
3"	2.688"	<b>15WLI-G300</b>	<b>96.98</b>	<b>15WLI-R300</b>	<b>470.48</b>
4"	3.000"	<b>15WLI-G400</b>	<b>140.20</b>	<b>15WLI-R400</b>	<b>600.99</b>
6"	3.000"	---	---	<b>15WLI-R600</b>	<b>1692.29</b>

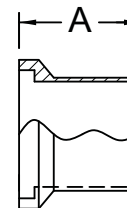

3



Ferrules

Q-line Weld Ferrules - 14WQ

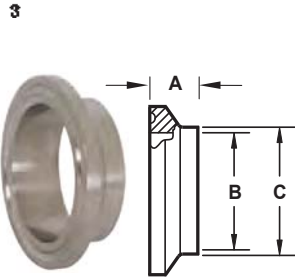

Tube OD	Dimensions			304 Stainless Steel	
	A	B	C	Part #	Price/E
1"	.531"	.870"	1.000"	14WQ-G100	\$50.48
1½"	.563"	1.370"	1.500"	14WQ-G150	43.08
2"	.813"	1.870"	2.000"	14WQ-G200	78.07
2½"	.938"	2.370"	2.500"	14WQ-G250	91.79
3"	.938"	2.870"	3.000"	14WQ-G300	168.24
4"	1.000"	3.834"	4.000"	14WQ-G400	264.23

End Caps

Male I-line Solid End Caps - 16AI-14I

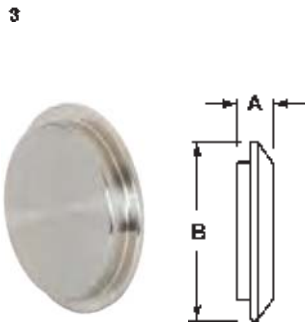

Tube OD	Dimensions		304 Stainless Steel		316L Stainless Steel	
	A	B	Part #	Price/E	Part #	Price/E
1"	.500"	1.985"	16AI-14I100	\$16.89	16AI-14I100R	\$57.26
1½"	.500"	1.985"	16AI-14I150	16.89	16AI-14I150R	57.26
2"	.562"	2.640"	16AI-14I200	25.84	16AI-14I200R	83.38
2½"	.750"	3.307"	16AI-14I250	43.27	16AI-14I250R	64.05
3"	.750"	3.870"	16AI-14I300	56.26	16AI-14I300R	186.62
4"	.750"	4.870"	16AI-14I400	96.33	16AI-14I400R	288.47
6"	.750"	7.495"	---	---	16AI-14I600R	1195.00
8"	.880"	9.495"	---	---	16AI-14I800R	1702.69

Female I-line Solid End Caps - 16AI-15I



Tube OD	Dimensions		304 Stainless Steel		316L Stainless Steel	
	A	B	Part #	Price/E	Part #	Price/E
1"	.500"	1.985"	16AI-15I100	\$16.89	16AI-15I100R	\$23.68
1½"	.500"	1.985"	16AI-15I150	16.89	16AI-15I150R	52.02
2"	.562"	2.640"	16AI-15I200	25.84	16AI-15I200R	84.87
2½"	.750"	3.307"	16AI-15I250	43.27	16AI-15I250R	191.62
3"	.750"	3.870"	16AI-15I300	56.26	16AI-15I300R	189.41
4"	.750"	4.870"	16AI-15I400	96.33	16AI-15I400R	140.23
6"	.750"	7.495"	---	---	16AI-15I600R	336.46
8"	.880"	9.495"	---	---	16AI-15I800R	551.38

Q-Line Solid End Caps - 16AQ

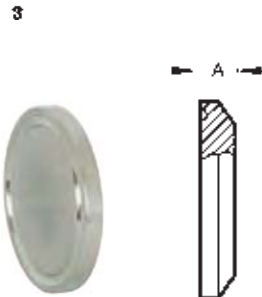

Tube OD	Dimension A	304 Stainless Steel	
	A	Part #	Price/E
1"	.313"	16AQ-G100	\$68.38
1½"	.313"	16AQ-G150	44.55
2"	.438"	16AQ-G200	64.10
2½"	.500"	16AQ-G250	176.92
3"	.500"	16AQ-G300	230.77
4"	.625"	16AQ-G400	292.30



## I-Line Gaskets

## Buna-N I-Line Gaskets - Black

## Features:

- color code: red dot
- meets 21CFR 177.2600
- 3/32" thickness

Size	Buna-N	
	Part #	Price/E
1"	40IH100	\$1.74
1½"	40IH150	1.54
2"	40IH200	1.41
2½"	40IH250	2.62
3"	40IH300	3.28
4"	40IH400	4.23
6"	40IH600	19.42
8"	40IH800	38.14



## PTFE I-Line Gaskets - White

## Features:

- color code: no dot
- meets 21CFR 177.1550
- passed USP class VI cytotoxicity testing
- 1/16" thickness

Size	PTFE	
	Part #	Price/E
1"	40IT100	\$2.03
1½"	40IT150	3.26
2"	40IT200	3.08
2½"	40IT250	3.95
3"	40IT300	4.13
4"	40IT400	5.96
6"	40IT600	107.47
8"	40IT800	157.80



PTFE is a material subject to plastic flow. When cycled through heat and then cooled down in process lines, PTFE gaskets will not return to the original configuration and it will continue to compress as the cycling continues. This plastic flow will allow leakage if clamp torques are not maintained. 

## EPDM I-Line Gaskets - White

## Features:

- color code: three green dots
- meets 21CFR 177.2600
- passed USP class VI cytotoxicity testing
- peroxide cured
- 3/32" thickness

Size	EPDM	
	Part #	Price/E
1"	40IE100	\$3.02
1½"	40IE150	2.82
2"	40IE200	3.28
2½"	40IE250	4.23
3"	40IE300	6.37
4"	40IE400	8.91
6"	40IE600	POR
8"	40IE800	76.42



Visit [dixonvalve.com](http://dixonvalve.com) for sizing charts

I-Line Gaskets

FKM I-Line Gaskets - Black

Features:

- color code: one white dot, one yellow dot
- meets 21CFR 177.1550
- passed USP Class VI Cytotoxicity testing
- peroxide cured
- 1/16" thickness



Size	Part #	FKM	Price/E
1"	40IV100		\$10.63
1½"	40IV150		8.52
2"	40IV200		10.13
2½"	40IV250		12.08
3"	40IV300		14.62
4"	40IV400		20.51
6"	40IV600		112.37
8"	40IV800		92.51

Q-line Gaskets

Buna-N Q-Line Gaskets - Black

Features:

- color code: red dot
- meets 21CFR 177.2600



Size	Part #	Buna-N	Price/E
1"	40QH100		\$3.46
1½"	40QH150		3.46
2"	40QH200		4.55
2½"	40QH250		5.64
3"	40QH300		7.88
4"	40QH400		11.47

PTFE Q-Line Gaskets - White

Features:

- color code: no dot
- meets 21CFR 177.1550
- passed USP Class VI Cytotoxicity testing



Size	Part #	PTFE	Price/E
1"	40QT100		\$10.45
1½"	40QT150		22.41
2"	40QT200		31.37
2½"	40QT250		36.19
3"	40QT300		22.56
4"	40QT400		34.69

PTFE is a material subject to plastic flow. When cycled through heat and then cooled down in process lines, PTFE gaskets will not return to the original configuration and it will continue to compress as the cycling continues. This plastic flow will allow leakage if clamp torques are not maintained.



Pipe Size Clamps

Schedule 5S and 10S Single Pin Heavy Duty Clamps - 13MHHV

Pipe Size	Service Pressure PSI Rating @ 70°F (21°C) <sup>1</sup>	Dimension A	304 Stainless Steel	
			Part #	Price/E
1"	500	2.122"	13MHHV100	\$13.93
1½"	450	2.654"	13MHHV150	16.89
2"	400	3.185"	13MHHV200	19.66
2½"	350	3.717"	13MHHV250	21.81
3"	250	4.263"	13MHHV300	43.94
4"	150	5.263"	13MHHV400	65.95
6"	100	7.500"	13MHHV600	219.98



Pipe, Welding  
& Tube Fittings

<sup>1</sup> wing nut tightened to 25 in. lbs. of torque

Bolted Clamp - 13MHPV400

Pipe Size	Service Pressure PSI Rating @ 70°F (21°C) <sup>1</sup>	Dimension A	304 Stainless Steel	
			Part #	Price/E
4"	400	5.187"	13MHPV400	\$100.32

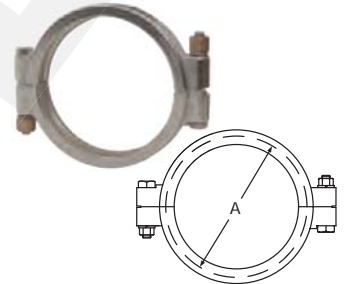

<sup>1</sup> nut tightened to 20 ft. lbs. of torque

- For additional information on pipe dimensions please reference dixonvalve.com.

Pipe Size Ferrules

Schedule 5S Short Weld Ferrules - 14WMV

Pipe Size	Dimensions			Part #	Price/E
	A	B	C		
1"	.500"	1.185"	1.315"	14WMV-R100	\$26.20
1½"	.500"	1.770"	1.900"	14WMV-R150	35.54
2"	.500"	2.245"	2.375"	14WMV-R200	52.38
2½"	.500"	2.709"	2.875"	14WMV-R250	67.62
3"	.500"	3.334"	3.500"	14WMV-R300	101.88
4"	.625"	4.334"	4.500"	14WMV-R400	181.64
6"	.875"	6.407"	6.625"	14WMV-R600	217.64

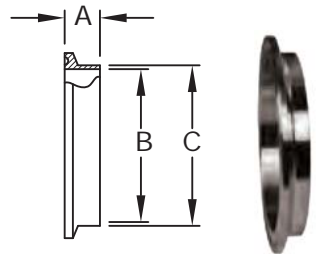

Schedule 10S Short Weld Ferrules - 14WMX

Pipe Size	Dimensions			Part #	Price/E
	A	B	C		
1"	.500"	1.097"	1.315"	14WMX-R100	\$26.20
1½"	.500"	1.682"	1.900"	14WMX-R150	35.54
2"	.500"	2.157"	2.375"	14WMX-R200	52.38
2½"	.500"	2.635"	2.875"	14WMX-R250	67.62
3"	.500"	3.260"	3.500"	14WMX-R300	101.88
4"	.625"	4.260"	4.500"	14WMX-R400	181.64

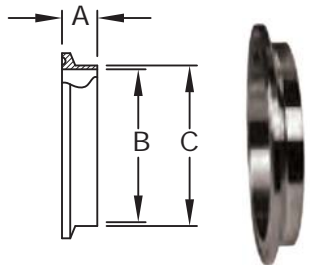

- For additional information on pipe dimensions please reference dixonvalve.com.

Pipe Size Ferrules

Pipe, Welding & Tube Fittings

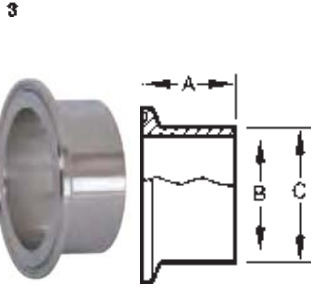

Schedule 5S Long Weld Ferrules - L14AM7V

Pipe Size	Dimensions			316L Stainless Steel	
	A	B	C	Part #	Price/E
1"	1.125"	1.185"	1.315"	<b>L14AM7V-R100</b>	<b>\$51.37</b>
1½"	1.125"	1.770"	1.900"	<b>L14AM7V-R150</b>	<b>72.37</b>
2"	1.125"	2.245"	2.375"	<b>L14AM7V-R200</b>	<b>108.07</b>
2½"	1.125"	2.709"	2.875"	<b>L14AM7V-R250</b>	<b>126.33</b>
3"	1.125"	3.334"	3.500"	<b>L14AM7V-R300</b>	<b>195.78</b>
4"	1.125"	4.334"	4.500"	<b>L14AM7V-R400</b>	<b>283.96</b>

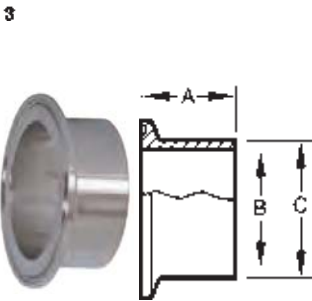

Schedule 10S Long Weld Ferrules - L14AM7X

Pipe Size	Dimensions			316L Stainless Steel	
	A	B	C	Part #	Price/E
1"	1.125"	1.097"	1.315"	<b>L14AM7X-R100</b>	<b>\$51.37</b>
1½"	1.125"	1.682"	1.900"	<b>L14AM7X-R150</b>	<b>72.37</b>
2"	1.125"	2.157"	2.375"	<b>L14AM7X-R200</b>	<b>108.07</b>
2½"	1.125"	2.635"	2.875"	<b>L14AM7X-R250</b>	<b>126.33</b>
3"	1.125"	3.260"	3.500"	<b>L14AM7X-R300</b>	<b>195.78</b>
4"	1.125"	4.260"	4.500"	<b>L14AM7X-R400</b>	<b>283.96</b>

• For additional information on pipe dimensions please reference dixonvalve.com.

Pipe Size End Caps

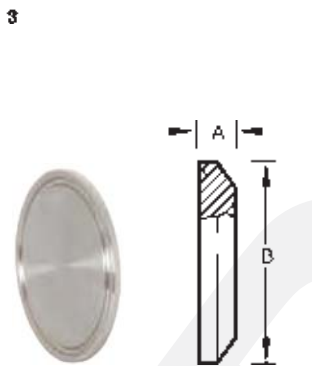

Schedule 5S and 10S Solid End Caps - 16AMV

Pipe Size	Dimensions		304 Stainless Steel		316L Stainless Steel	
	A	B	Part #	Price/E	Part #	Price/E
1"	.250"	1.984"	<b>16AMV-G100</b>	<b>\$6.73</b>	<b>16AMV-R100</b>	<b>\$8.34</b>
1½"	.250"	2.516"	<b>16AMV-G150</b>	<b>8.55</b>	<b>16AMV-R150</b>	<b>12.11</b>
2"	.250"	3.047"	<b>16AMV-G200</b>	<b>13.06</b>	<b>16AMV-R200</b>	<b>18.30</b>
2½"	.250"	3.579"	<b>16AMV-G250</b>	<b>17.63</b>	<b>16AMV-R250</b>	<b>24.23</b>
3"	.312"	4.125"	<b>16AMV-G300</b>	<b>240.31</b>	<b>16AMV-R300</b>	<b>112.43</b>
4"	.312"	5.125"	<b>16AMV-G400</b>	<b>307.69</b>	<b>16AMV-R400</b>	<b>172.68</b>

• Specify if you are using a piping system or a tubing system when ordering.  
 • For additional information on pipe dimensions please reference dixonvalve.com.

Pipe Size Adapters

Tube OD Weld x Schedule 5S Weld Adapters - B19WV

Pipe Size	Dimension A	Tube Wall Thickness	Pipe Wall Thickness	316L Stainless Steel	
				Part #	Price/E
1"	2.000"	.065"	.065"	<b>B19WV-R100</b>	<b>\$33.28</b>
1½"	2.500"	.065"	.065"	<b>B19WV-R150</b>	<b>63.32</b>
2"	2.500"	.065"	.065"	<b>B19WV-R200</b>	<b>113.88</b>
2½"	2.500"	.065"	.084"	<b>B19WV-R250</b>	<b>119.80</b>
3"	2.500"	.065"	.084"	<b>B19WV-R300</b>	<b>210.00</b>
4"	3.000"	.084"	.084"	<b>B19WV-R400</b>	<b>258.47</b>

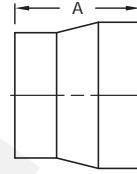

Pipe, Welding & Tube Fittings

3

Tube OD Weld x Schedule 10S Weld Adapters - B19WX

Pipe Size	Dimension A	Tube Wall Thickness	Pipe Wall Thickness	316L Stainless Steel	
				Part #	Price/E
1"	2.000"	.065"	.109"	<b>B19WX-R100</b>	<b>\$79.48</b>
1½"	2.500"	.065"	.109"	<b>B19WX-R150</b>	<b>98.95</b>
2"	2.500"	.065"	.109"	<b>B19WX-R200</b>	<b>118.72</b>
2½"	2.500"	.065"	.120"	<b>B19WX-R250</b>	<b>132.47</b>
3"	2.500"	.065"	.120"	<b>B19WX-R300</b>	<b>164.42</b>
4"	3.000"	.084"	.120"	<b>B19WX-R400</b>	<b>280.90</b>



3

Clamp x Schedule 10S Weld Adapters - B19MPX

Pipe Size	Dimensions			Pipe Wall Thickness	316L Stainless Steel	
	A	B	C		Part #	Price/E
1"	1.125"	1.097"	1.315"	.109"	<b>B19MPX-R100</b>	<b>\$57.46</b>
1½"	1.125"	1.682"	1.900"	.109"	<b>B19MPX-R150</b>	<b>114.46</b>
2"	1.125"	2.157"	2.375"	.109"	<b>B19MPX-R200</b>	<b>172.38</b>
2½"	1.125"	2.635"	2.875"	.120"	<b>B19MPX-R250</b>	<b>189.23</b>
3"	1.125"	3.260"	3.500"	.120"	<b>B19MPX-R300</b>	<b>235.38</b>
4"	1.125"	4.260"	4.500"	.120"	<b>B19MPX-R400</b>	<b>282.70</b>

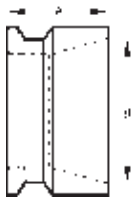

3

• For additional information on pipe dimensions please reference [dixonvalve.com](http://dixonvalve.com).



Pipe Size Hangers

Pipe, Welding & Tube Fittings

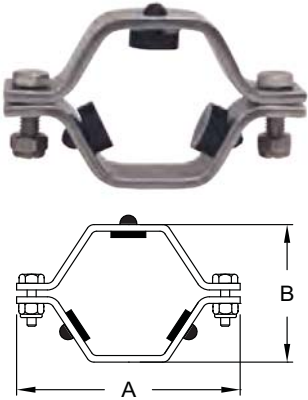

Pipe Size Hex Hanger with Rubber Grommets - B24RV<sup>1</sup>

Pipe Size	Dimensions		304 Stainless Steel	
	A	B	Part #	Price/E
1"	3.625"	2.125"	<b>B24RV-G100</b>	<b>\$24.68</b>
1½"	3.625"	2.125"	<b>B24RV-G150</b>	<b>26.85</b>
2"	4.312"	2.625"	<b>B24RV-G200</b>	<b>29.67</b>
2½"	4.875"	3.125"	<b>B24RV-G250</b>	<b>33.65</b>
3"	5.375"	3.625"	<b>B24RV-G300</b>	<b>39.55</b>
4"	7.500"	4.750"	<b>B24RV-G400</b>	<b>40.19</b>
6"	9.000"	6.625"	<b>B24RV-G600</b>	<b>113.91</b>

<sup>1</sup> for coupler options call Dixon®

Pipe Size Hex Hanger with Polypropylene Sleeves - B24PV<sup>1</sup>

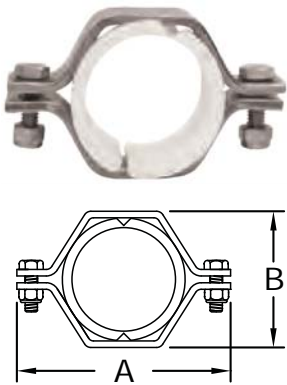

Pipe Size	Dimensions		304 Stainless Steel	
	A	B	Part #	Price/E
1"	3.750"	3.000"	<b>B24PV-G100</b>	<b>\$39.42</b>
1½"	4.312"	2.625"	<b>B24PV-G150</b>	<b>40.06</b>
2"	5.000"	3.125"	<b>B24PV-G200</b>	<b>44.29</b>
2½"	5.625"	3.500"	<b>B24PV-G250</b>	<b>54.74</b>
3"	6.000"	4.250"	<b>B24PV-G300</b>	<b>54.94</b>
4"	7.500"	2.000"	<b>B24PV-G400</b>	<b>62.69</b>
6"	9.750"	7.125"	<b>B24PV-G600</b>	<b>221.67</b>

<sup>1</sup> for coupler options call Dixon®

Pipe Size Sleeves - 13PV



Size	Polypropylene	
	Part #	Price/E
1"	<b>13PV-100</b>	<b>\$19.02</b>
1½"	<b>13PV-150</b>	<b>19.02</b>
2"	<b>13PV-200</b>	<b>19.73</b>
2½"	<b>13PV-250</b>	<b>28.89</b>
3"	<b>13PV-300</b>	<b>20.14</b>
4"	<b>13PV-400</b>	<b>29.66</b>
6"	<b>13PV-600</b>	<b>127.90</b>

• For additional information on pipe dimensions please reference [dixonvalve.com](http://dixonvalve.com).



## Schedule 5S and 10S Pipe Gaskets

## Buna-N Pipe Gaskets- 40MPV-U, Black

## Features:

- color code: red dot
- meets 21CFR 177.2600

Size	Buna-N	
	Part #	Price/E
1"	<b>40MPV-U100</b>	<b>\$10.66</b>
1½"	<b>40MPV-U150</b>	<b>7.11</b>
2"	<b>40MPV-U200</b>	<b>7.50</b>
2½"	<b>40MPV-U250</b>	<b>9.23</b>
3"	<b>40MPV-U300</b>	<b>7.88</b>
4"	<b>40MPV-U400</b>	<b>6.57</b>



## PTFE Pipe Gaskets - 40MPV-G, White

## Features:

- color code: no dot
- meets 21CFR 177.1550
- passed USP Class VI Cytotoxicity testing
- not recommended for use with bolted clamps



Size	PTFE	
	Part #	Price/E
1"	<b>40MPV-G100</b>	<b>\$33.21</b>
1½"	<b>40MPV-G150</b>	<b>25.46</b>
2"	<b>40MPV-G200</b>	<b>39.93</b>
2½"	<b>40MPV-G250</b>	<b>49.40</b>
3"	<b>40MPV-G300</b>	<b>68.37</b>
4"	<b>40MPV-G400</b>	<b>65.46</b>



PTFE is a material subject to plastic flow. When cycled through heat and then cooled down in process lines, PTFE gaskets will not return to the original configuration and it will continue to compress as the cycling continues. This plastic flow will allow leakage if clamp torques are not maintained.



Weld Elbows

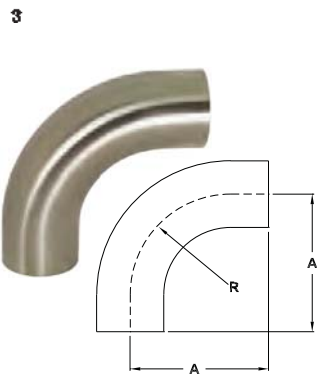

Polished 90° Weld Elbows with Tangents - B2S

Tube OD	Dimensions		Wall Thickness	polished ID/OD 304 Stainless Steel		polished ID/OD 316L Stainless Steel	
	A	R		Part #	Price/E	Part #	Price/E
1/2"	3.000"	1.125"	.065"	---	---	<b>B2S-R50P</b>	<b>\$52.02</b>
3/4"	3.000"	1.125"	.065"	---	---	<b>B2S-R75P</b>	<b>49.20</b>
1"	2.062"	1.500"	.065"	<b>B2S-G100P</b>	<b>\$26.79</b>	<b>B2S-R100P</b>	<b>30.28</b>
1 1/2"	2.937"	2.250"	.065"	<b>B2S-G150P</b>	<b>28.54</b>	<b>B2S-R150P</b>	<b>34.62</b>
2"	4.062"	3.000"	.065"	<b>B2S-G200P</b>	<b>34.65</b>	<b>B2S-R200P</b>	<b>45.96</b>
2 1/2"	5.187"	3.750"	.065"	<b>B2S-G250P</b>	<b>49.60</b>	<b>B2S-R250P</b>	<b>69.68</b>
3"	6.312"	4.500"	.065"	<b>B2S-G300P</b>	<b>69.63</b>	<b>B2S-R300P</b>	<b>101.55</b>
4"	8.312"	6.000"	.083"	<b>B2S-G400P</b>	<b>139.30</b>	<b>B2S-R400P</b>	<b>174.63</b>

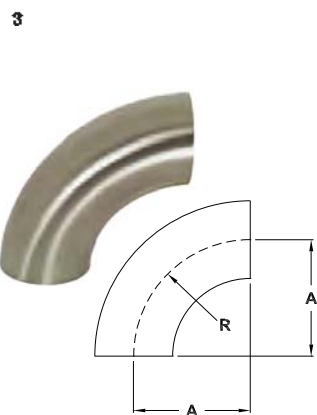

Polished 90° Weld Elbows - B2WCL

Tube OD	Dimensions		Wall Thickness	polished ID/OD 304 Stainless Steel		polished ID/OD 316L Stainless Steel	
	A	R		Part #	Price/E	Part #	Price/E
1/2"	1.125"	1.125"	.065"	---	---	<b>B2WCL-R50P</b>	<b>\$31.15</b>
3/4"	1.125"	1.125"	.065"	---	---	<b>B2WCL-R75P</b>	<b>32.21</b>
1"	1.500"	1.500"	.065"	<b>B2WCL-G100P</b>	<b>\$15.29</b>	<b>B2WCL-R100P</b>	<b>19.22</b>
1 1/2"	2.250"	2.250"	.065"	<b>B2WCL-G150P</b>	<b>19.92</b>	<b>B2WCL-R150P</b>	<b>25.64</b>
2"	3.000"	3.000"	.065"	<b>B2WCL-G200P</b>	<b>27.72</b>	<b>B2WCL-R200P</b>	<b>33.42</b>
2 1/2"	3.750"	3.750"	.065"	<b>B2WCL-G250P</b>	<b>40.76</b>	<b>B2WCL-R250P</b>	<b>60.13</b>
3"	4.500"	4.500"	.065"	<b>B2WCL-G300P</b>	<b>49.30</b>	<b>B2WCL-R300P</b>	<b>74.29</b>
4"	6.000"	6.000"	.083"	<b>B2WCL-G400P</b>	<b>110.07</b>	<b>B2WCL-R400P</b>	<b>137.79</b>
6"	9.000"	9.000"	.109"	<b>B2WCL-G600P</b>	<b>407.88</b>	<b>B2WCL-R600P</b>	<b>480.00</b>
8"	12.000"	12.000"	.120"	<b>B2WCL-G800P</b>	<b>795.39</b>	<b>B2WCL-R800P</b>	<b>1035.90</b>

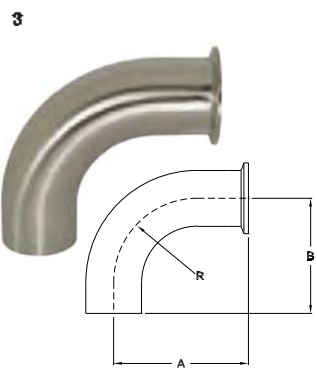

Polished 90° Clamp x Weld Elbows - B2CM

Tube OD	Dimensions			Wall Thickness	polished ID/OD 304 Stainless Steel		polished ID/OD 316L Stainless Steel	
	A	B	R		Part #	Price/E	Part #	Price/E
1"	2.562"	2.062"	1.500"	.065"	<b>B2CM-G100</b>	<b>\$55.90</b>	<b>B2CM-R100</b>	<b>\$84.81</b>
1 1/2"	3.438"	2.937"	2.250"	.065"	<b>B2CM-G150</b>	<b>60.13</b>	<b>B2CM-R150</b>	<b>78.04</b>
2"	4.562"	4.062"	3.000"	.065"	<b>B2CM-G200</b>	<b>76.11</b>	<b>B2CM-R200</b>	<b>110.66</b>
2 1/2"	5.688"	5.187"	3.750"	.065"	<b>B2CM-G250</b>	<b>117.18</b>	<b>B2CM-R250</b>	<b>103.08</b>
3"	6.812"	6.312"	4.500"	.065"	<b>B2CM-G300</b>	<b>144.95</b>	<b>B2CM-R300</b>	<b>216.65</b>
4"	8.937"	8.312"	6.000"	.083"	<b>B2CM-G400</b>	<b>265.00</b>	<b>B2CM-R400</b>	<b>326.15</b>

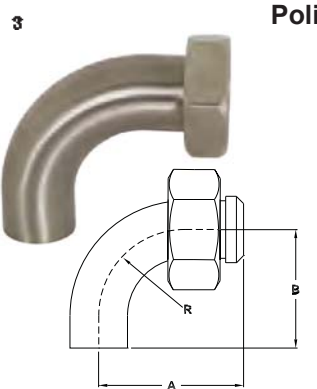

Polished 90° Plain Bevel Seat with Hex Nut x Weld Elbows - B2FP

Tube OD	Dimensions			Wall Thickness	polished ID/OD 304 Stainless Steel	
	A	B	R		Part #	Price/E
1 1/2"	3.656"	2.937"	2.250"	.065"	<b>B2FP-G150</b>	<b>\$135.99</b>
2"	4.812"	4.062"	3.000"	.065"	<b>B2FP-G200</b>	<b>161.55</b>
2 1/2"	6.062"	5.187"	3.750"	.065"	<b>B2FP-G250</b>	<b>221.73</b>
3"	7.218"	6.312"	4.500"	.065"	<b>B2FP-G300</b>	<b>268.94</b>

Weld Elbows

Polished 45° Weld Elbows with Tangents - B2KS

Tube OD	Dimensions		Wall Thickness	polished ID/OD 304 Stainless Steel		polished ID/OD 316L Stainless Steel	
	A	R		Part #	Price/E	Part #	Price/E
¾"	2.250"	2.250"	.065"	---	---	<b>B2KS-R75P</b>	<b>\$46.99</b>
1"	1.188"	1.188"	.065"	<b>B2KS-G100P</b>	<b>\$24.46</b>	<b>B2KS-R100P</b>	<b>24.46</b>
1½"	1.625"	1.625"	.065"	<b>B2KS-G150P</b>	<b>25.28</b>	<b>B2KS-R150P</b>	<b>29.36</b>
2"	2.312"	2.312"	.065"	<b>B2KS-G200P</b>	<b>31.59</b>	<b>B2KS-R200P</b>	<b>38.05</b>
2½"	3.000"	3.000"	.065"	<b>B2KS-G250P</b>	<b>44.17</b>	<b>B2KS-R250P</b>	<b>59.30</b>
3"	3.688"	3.688"	.065"	<b>B2KS-G300P</b>	<b>61.84</b>	<b>B2KS-R300P</b>	<b>81.55</b>
4"	4.812"	4.812"	.083"	<b>B2KS-G400P</b>	<b>101.83</b>	<b>B2KS-R400P</b>	<b>139.30</b>

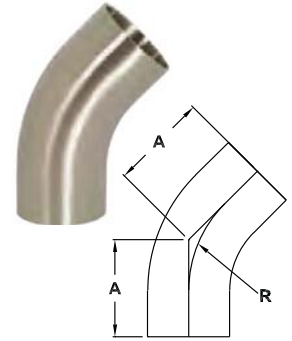

Pipe, Welding & Tube Fittings

Polished 45° Weld Elbows - B2WK

Tube OD	Dimensions		Wall Thickness	polished ID/OD 304 Stainless Steel		polished ID/OD 316L Stainless Steel	
	A	R		Part #	Price/E	Part #	Price/E
1"	.625"	1.500"	.065"	<b>B2WK-G100P</b>	<b>\$14.57</b>	<b>B2WK-R100P</b>	<b>\$22.02</b>
1½"	.937"	2.250"	.065"	<b>B2WK-G150P</b>	<b>17.84</b>	<b>B2WK-R150P</b>	<b>20.38</b>
2"	1.250"	3.000"	.065"	<b>B2WK-G200P</b>	<b>23.56</b>	<b>B2WK-R200P</b>	<b>36.11</b>
2½"	1.562"	3.750"	.065"	<b>B2WK-G250P</b>	<b>35.33</b>	<b>B2WK-R250P</b>	<b>49.94</b>
3"	1.875"	4.500"	.065"	<b>B2WK-G300P</b>	<b>60.57</b>	<b>B2WK-R300P</b>	<b>72.22</b>
4"	2.500"	6.000"	.083"	<b>B2WK-G400P</b>	<b>101.93</b>	<b>B2WK-R400P</b>	<b>143.27</b>
6"	3.750"	9.000"	.109"	<b>B2WK-G600P</b>	<b>322.50</b>	<b>B2WK-R600P</b>	<b>444.61</b>
8"	5.000"	12.000"	.120"	---	---	<b>B2WK-R800P</b>	<b>706.73</b>

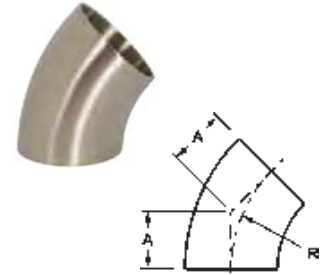

Polished 45° Clamp x Weld Elbows - B2KM

Tube OD	Dimensions			Wall Thickness	polished ID/OD 304 Stainless Steel		polished ID/OD 316L Stainless Steel	
	A	B	R		Part #	Price/E	Part #	Price/E
1"	1.188"	1.688"	1.500"	.065"	<b>B2KM-G100</b>	<b>\$94.92</b>	<b>B2KM-R100</b>	<b>\$88.72</b>
1½"	1.625"	2.125"	2.250"	.065"	<b>B2KM-G150</b>	<b>95.49</b>	<b>B2KM-R150</b>	<b>93.77</b>
2"	2.312"	2.812"	3.000"	.065"	<b>B2KM-G200</b>	<b>106.91</b>	<b>B2KM-R200</b>	<b>107.91</b>
2½"	3.000"	3.500"	3.750"	.065"	<b>B2KM-G250</b>	<b>152.31</b>	<b>B2KM-R250</b>	<b>131.26</b>
3"	3.688"	4.188"	4.500"	.065"	<b>B2KM-G300</b>	<b>171.37</b>	<b>B2KM-R300</b>	<b>172.78</b>
4"	4.812"	5.437"	6.000"	.083"	<b>B2KM-G400</b>	<b>260.09</b>	<b>B2KM-R400</b>	<b>263.04</b>

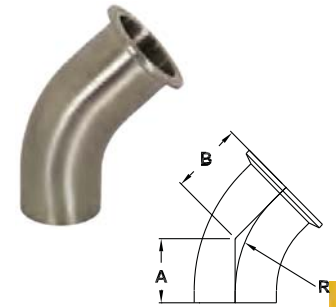

Weld Sweep Elbows

Feature:

- tangents, 45° and other radii elbows are available, call Dixon® for information

Polished 12" 90° Weld Sweep Elbows - B2SXL

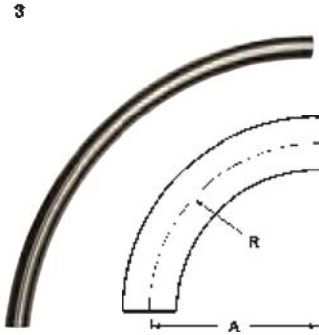

Tube OD	Dimensions		316L Stainless Steel	
	A	R	Part #	Price/E
1½"	12.00"	12.00"	<b>B2SXL12-R150</b>	<b>\$910.77</b>
2"	12.00"	12.00"	<b>B2SXL12-R200</b>	<b>969.23</b>
3"	12.00"	12.00"	<b>B2SXL12-R300</b>	<b>1137.42</b>
4"	12.00"	12.00"	<b>B2SXL12-R400</b>	<b>1446.16</b>

Polished 18" 90° Weld Sweep Elbows - B2SXL

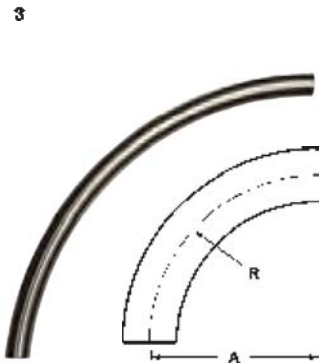

Tube OD	Dimensions		316L Stainless Steel	
	A	R	Part #	Price/E
1½"	18.00"	18.00"	<b>B2SXL18-R150</b>	<b>\$1169.23</b>
2"	18.00"	18.00"	<b>B2SXL18-R200</b>	<b>1169.24</b>
2½"	18.00"	18.00"	<b>B2SXL18-R250</b>	<b>1193.85</b>
3"	18.00"	18.00"	<b>B2SXL18-R300</b>	<b>1516.56</b>

Polished 24" 90° Weld Sweep Elbows - B2SXL

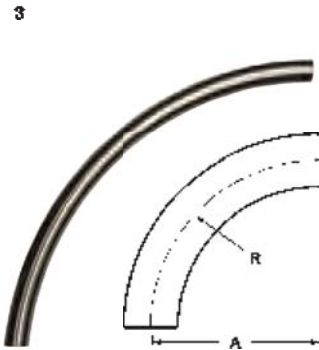

Tube OD	Dimensions		316L Stainless Steel	
	A	R	Part #	Price/E
1½"	24.00"	24.00"	<b>B2SXL24-R150</b>	<b>\$1296.41</b>
2"	24.00"	24.00"	<b>B2SXL24-R200</b>	<b>1193.85</b>
2½"	24.00"	24.00"	<b>B2SXL24-R250</b>	<b>1292.30</b>
3"	24.00"	24.00"	<b>B2SXL24-R300</b>	<b>1681.39</b>

Polished 36" 90° Weld Sweep Elbows - B2SXL

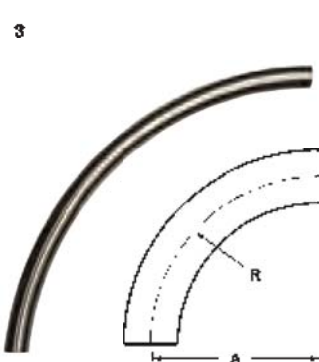

Tube OD	Dimensions		316L Stainless Steel	
	A	R	Part #	Price/E
3"	36.00"	36.00"	<b>B2SXL36-R300</b>	<b>\$2785.80</b>
4"	36.00"	36.00"	<b>B2SXL36-R400</b>	<b>3307.69</b>

Weld Tees

Polished Short Weld Tees - B7WWW

Tube OD	Dimensions		Wall Thickness	polished ID/OD 304 Stainless Steel		polished ID/OD 316L Stainless Steel	
	A	B		Part #	Price/E	Part #	Price/E
1"	2.250"	1.125"	.065"	<b>B7WWW-G100P</b>	<b>\$27.95</b>	<b>B7WWW-R100P</b>	<b>\$42.40</b>
1½"	3.312"	1.656"	.065"	<b>B7WWW-G150P</b>	<b>37.28</b>	<b>B7WWW-R150P</b>	<b>41.93</b>
2"	4.124"	2.062"	.065"	<b>B7WWW-G200P</b>	<b>44.84</b>	<b>B7WWW-R200P</b>	<b>50.96</b>
2½"	4.688"	2.344"	.065"	<b>B7WWW-G250P</b>	<b>56.05</b>	<b>B7WWW-R250P</b>	<b>68.29</b>
3"	5.188"	2.594"	.065"	<b>B7WWW-G300P</b>	<b>78.48</b>	<b>B7WWW-R300P</b>	<b>102.50</b>
4"	6.876"	3.438"	.083"	<b>B7WWW-G400P</b>	<b>122.31</b>	<b>B7WWW-R400P</b>	<b>146.15</b>

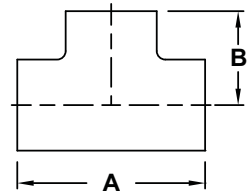

Pipe, Welding & Tube Fittings

Polished Long Weld Tees - B7W

Tube OD	Dimensions		Wall Thickness	polished ID/OD 304 Stainless Steel		polished ID/OD 316L Stainless Steel	
	A	B		Part #	Price/E	Part #	Price/E
¾"	4.000"	2.000"	.065"	---	---	<b>B7W-R75P</b>	<b>\$73.22</b>
1"	3.750"	1.875"	.065"	<b>B7W-G100P</b>	<b>\$32.03</b>	<b>B7W-R100P</b>	<b>36.11</b>
1½"	4.500"	2.250"	.065"	<b>B7W-G150P</b>	<b>37.09</b>	<b>B7W-R150P</b>	<b>48.92</b>
2"	6.000"	3.000"	.065"	<b>B7W-G200P</b>	<b>44.03</b>	<b>B7W-R200P</b>	<b>66.24</b>
2½"	6.000"	3.000"	.065"	<b>B7W-G250P</b>	<b>44.16</b>	<b>B7W-R250P</b>	<b>53.73</b>
3"	6.500"	3.250"	.065"	<b>B7W-G300P</b>	<b>81.55</b>	<b>B7W-R300P</b>	<b>111.10</b>
4"	7.750"	3.875"	.083"	<b>B7W-G400P</b>	<b>152.88</b>	<b>B7W-R400P</b>	<b>209.67</b>

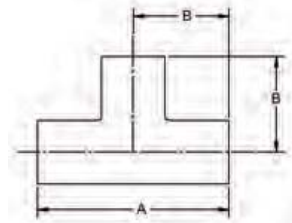

Polished Reducing Weld Tees - B7RWWW

Tube OD	Dimensions				Wall Thick.	polished ID/OD 304 Stainless Steel		polished ID/OD 316L Stainless Steel	
	A	B	C	D		Part #	Price/E	Part #	Price/E
1½" x 1"	3.312"	1.375"	1.500"	1.000"	.065"	<b>B7RWWW-G150100P</b>	<b>\$57.08</b>	<b>B7RWWW-R150100P</b>	<b>\$65.23</b>
2" x 1"	4.124"	1.625"	2.000"	1.000"	.065"	<b>B7RWWW-G200100P</b>	<b>78.47</b>	<b>B7RWWW-R200100P</b>	<b>88.07</b>
2" x 1½"	4.124"	1.906"	2.000"	1.500"	.065"	<b>B7RWWW-G200150P</b>	<b>78.47</b>	<b>B7RWWW-R200150P</b>	<b>88.07</b>
2½" x 1½"	4.688"	2.156"	2.500"	1.500"	.065"	<b>B7RWWW-G250150P</b>	<b>69.90</b>	<b>B7RWWW-R250150P</b>	<b>82.71</b>
2½" x 2"	4.688"	2.312"	2.500"	2.000"	.065"	<b>B7RWWW-G250200P</b>	<b>71.06</b>	<b>B7RWWW-R250200P</b>	<b>82.71</b>
3" x 1½"	5.188"	2.406"	3.000"	1.500"	.065"	<b>B7RWWW-G300150P</b>	<b>97.85</b>	<b>B7RWWW-R300150P</b>	<b>111.83</b>
3" x 2"	5.188"	2.562"	3.000"	2.000"	.065"	<b>B7RWWW-G300200P</b>	<b>97.85</b>	<b>B7RWWW-R300200P</b>	<b>111.83</b>
4" x 2"	6.876"	3.062"	4.000"	2.000"	.083"	<b>B7RWWW-G400200P</b>	<b>170.07</b>	<b>B7RWWW-R400200P</b>	<b>201.51</b>
4" x 3"	6.876"	3.094"	4.000"	3.000"	.083"	<b>B7RWWW-G400300P</b>	<b>171.24</b>	<b>B7RWWW-R400300P</b>	<b>203.84</b>

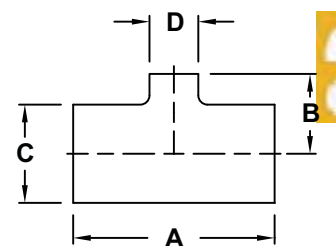



Weld Adapters

Long Weld Hose Adapters - 14WHRL

Pipe, Welding & Tube Fittings

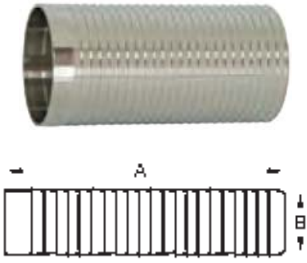

Feature:

- suitable for use with band clamps

Tube OD	Dimensions		Wall Thickness	316L Stainless Steel	
	A	B		Part #	Price/E
1"	3.000"	1.030"	.116"	<b>14WHRL-R100</b>	<b>\$36.01</b>
1½"	4.500"	1.030"	.116"	<b>14WHRL-R150</b>	<b>63.03</b>
2"	4.500"	2.030"	.116"	<b>14WHRL-R200</b>	<b>80.43</b>
2½"	5.000"	2.530"	.116"	<b>14WHRL-R250</b>	<b>107.58</b>
3"	5.000"	3.030"	.116"	<b>14WHRL-R300</b>	<b>116.41</b>
4"	4.875"	4.030"	.116"	<b>14WHRL-R400</b>	<b>163.55</b>

Use of PVC tubing requires special installation techniques to prevent leakage. All assembly work must be done with heated tube. Cold durometer is 90 as opposed to rubber hose at 65 to 70 durometer. Banding buckles must be at 180° from one another. 

Weld Reducers

Polished Concentric Weld Reducers - B31W

3

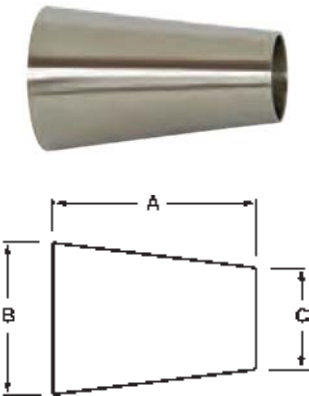

Tube OD	Dimensions			Wall Thickness	polished ID/OD 304 Stainless Steel		polished ID/OD 316L Stainless Steel	
	A	B	C		Part #	Price/E	Part #	Price/E
¾" x ½"	1.000"	.750"	.500"	.065"	---	---	<b>B31W-R7550P</b>	<b>\$57.08</b>
1" x ½"	2.000"	1.000"	.500"	.065"	---	---	<b>B31W-R10050P</b>	<b>108.97</b>
1" x ¾"	1.000"	1.000"	.750"	.065"	---	---	<b>B31W-R10075P</b>	<b>57.08</b>
1½" x ¾"	3.000"	1.500"	.750"	.065"	---	---	<b>B31W-R15075P</b>	<b>81.55</b>
1½" x 1"	2.000"	1.500"	1.000"	.065"	<b>B31W-G150100P</b>	<b>\$33.79</b>	<b>B31W-R150100P</b>	<b>37.28</b>
2" x 1"	4.000"	2.000"	1.000"	.065"	<b>B31W-G200100P</b>	<b>67.31</b>	<b>B31W-R200100P</b>	<b>79.20</b>
2" x 1½"	2.000"	2.000"	1.500"	.065"	<b>B31W-G200150P</b>	<b>37.28</b>	<b>B31W-R200150P</b>	<b>49.45</b>
2½" x 1½"	4.000"	2.500"	1.500"	.065"	<b>B31W-G250150P</b>	<b>63.42</b>	<b>B31W-R250150P</b>	<b>85.04</b>
2½" x 2"	2.000"	2.500"	2.000"	.065"	<b>B31W-G250200P</b>	<b>40.76</b>	<b>B31W-R250200P</b>	<b>31.11</b>
3" x 1½"	6.000"	3.000"	1.500"	.065"	<b>B31W-G300150P</b>	<b>114.15</b>	<b>B31W-R300150P</b>	<b>154.92</b>
3" x 2"	4.000"	3.000"	2.000"	.065"	<b>B31W-G300200P</b>	<b>60.05</b>	<b>B31W-R300200P</b>	<b>76.93</b>
3" x 2½"	2.000"	3.000"	2.500"	.065"	<b>B31W-G300250P</b>	<b>58.25</b>	<b>B31W-R300250P</b>	<b>84.81</b>
4" x 2"	8.000"	4.000"	2.000"	.083"	<b>B31W-G400200P</b>	<b>152.88</b>	<b>B31W-R400200P</b>	<b>186.38</b>
4" x 2½"	6.000"	4.000"	2.500"	.083"	<b>B31W-G400250P</b>	<b>145.61</b>	<b>B31W-R400250P</b>	<b>174.73</b>
4" x 3"	4.000"	4.000"	3.000"	.083"	<b>B31W-G400300P</b>	<b>88.67</b>	<b>B31W-R400300P</b>	<b>110.66</b>
6" x 3"	5.500"	6.000"	3.000"	.109"	<b>B31W-G600300P</b>	<b>289.91</b>	<b>B31W-R600300P</b>	<b>392.41</b>
6" x 4"	5.500"	6.000"	4.000"	.109"	<b>B31W-G600400P</b>	<b>323.07</b>	<b>B31W-R600400P</b>	<b>336.65</b>

Polished Eccentric Weld Reducers - B32W

3

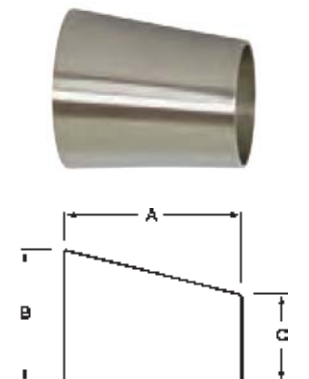

Tube OD	Dimensions			Wall Thickness	polished ID/OD 304 Stainless Steel		polished ID/OD 316L Stainless Steel	
	A	B	C		Part #	Price/E	Part #	Price/E
1" x ½"	2.000"	1.000"	.500"	.065"	---	---	<b>B32W-R10050P</b>	<b>\$114.15</b>
2" x 1"	4.000"	2.000"	1.000"	.065"	<b>B32W-G200100P</b>	<b>\$122.31</b>	<b>B32W-R200100P</b>	<b>133.73</b>
2" x 1½"	2.000"	2.000"	1.500"	.065"	<b>B32W-G200150P</b>	<b>51.25</b>	<b>B32W-R200150P</b>	<b>57.08</b>
2½" x 2"	2.000"	2.500"	2.000"	.065"	<b>B32W-G250200P</b>	<b>60.57</b>	<b>B32W-R250200P</b>	<b>40.85</b>
3" x 2"	4.000"	3.000"	2.000"	.065"	<b>B32W-G300200P</b>	<b>97.85</b>	<b>B32W-R300200P</b>	<b>101.93</b>
3" x 2½"	2.000"	3.000"	2.500"	.065"	<b>B32W-G300250P</b>	<b>81.55</b>	<b>B32W-R300250P</b>	<b>117.41</b>
4" x 2"	8.000"	4.000"	2.000"	.083"	<b>B32W-G400200P</b>	<b>215.49</b>	<b>B32W-R400200P</b>	<b>232.97</b>
4" x 3"	4.000"	4.000"	3.000"	.083"	<b>B32W-G400300P</b>	<b>125.00</b>	<b>B32W-R400300P</b>	<b>128.13</b>



Weld Crosses

Polished Weld Crosses - B9WWWW

Tube OD	Dimensions		Wall Thickness	polished ID/OD 304 Stainless Steel		polished ID/OD 316L Stainless Steel	
	A	B		Part #	Price/E	Part #	Price/E
1½"	3.312"	1.656"	.065"	<b>B9WWWW-G150P</b>	\$136.24	<b>B9WWWW-R150P</b>	\$105.99
2"	4.125"	2.062"	.065"	<b>B9WWWW-G200P</b>	122.31	<b>B9WWWW-R200P</b>	138.61
3"	5.187"	2.593"	.065"	<b>B9WWWW-G300P</b>	192.19	<b>B9WWWW-R300P</b>	285.39
4"	6.875"	3.437"	.083"	<b>B9WWWW-G400P</b>	414.69	<b>B9WWWW-R400P</b>	497.39

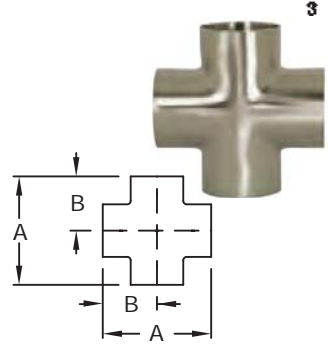

Pipe, Welding  
& Tube Fittings

Miscellaneous Weld Configurations

Polished Weld Laterals - B28WA

Tube OD	Dimensions			Wall Thickness	polished ID/OD 316L Stainless Steel	
	A	B	R		Part #	Price/E
1"	6.000"	1.000"	5.000"	.065"	<b>B28WA-R100P</b>	\$326.15
1½"	7.375"	1.188"	6.188"	.065"	<b>B28WA-R150P</b>	375.08
2"	8.750"	1.625"	7.125"	.065"	<b>B28WA-R200P</b>	538.15
2½"	10.000"	1.500"	8.500"	.065"	<b>B28WA-R250P</b>	684.93
3"	10.750"	1.875"	8.875"	.065"	<b>B28WA-R300P</b>	629.01
4"	12.812"	2.015"	10.750"	.083"	<b>B28WA-R400P</b>	955.16

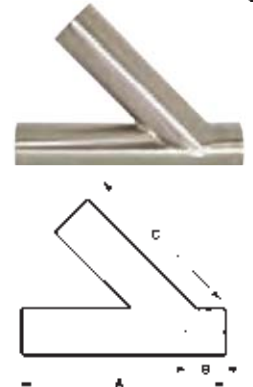

Polished Weld True Wyes - B28W

Tube OD	Dimensions		Wall Thickness	polished ID/OD 316L Stainless Steel	
	A	B		Part #	Price/E
1"	2.000"	2.438"	.065"	<b>B28W-R100P</b>	\$342.45
1½"	2.000"	2.438"	.065"	<b>B28W-R150P</b>	391.38
2"	2.625"	3.250"	.065"	<b>B28W-R200P</b>	407.70
2½"	3.370"	4.125"	.065"	<b>B28W-R250P</b>	512.53
3"	4.000"	4.875"	.065"	<b>B28W-R300P</b>	652.30
4"	5.375"	5.375"	.083"	<b>B28W-R400P</b>	1001.76

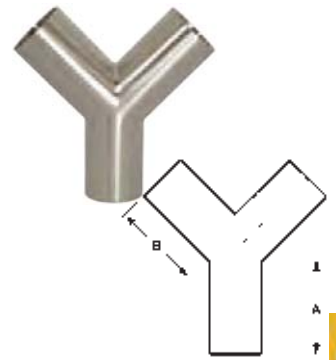

Polished Weld 180° Return Bends - B2WUL

Feature:

- bends are standard 1.5 x tube diameter

Tube OD	Dimensions		polished ID/OD 316L Stainless Steel	
	A	B	Part #	Price/E
1"	3.000"	2.000"	<b>B2WUL-R100P</b>	\$153.46
1½"	4.500"	3.000"	<b>B2WUL-R150P</b>	177.69
2"	6.000"	4.000"	<b>B2WUL-R200P</b>	292.30
2½"	7.500"	5.000"	<b>B2WUL-R250P</b>	339.23
3"	9.000"	6.000"	<b>B2WUL-R300P</b>	492.69
4"	12.000"	8.000"	<b>B2WUL-R400P</b>	686.53

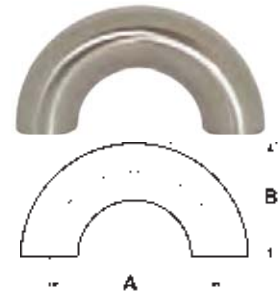



Weld End Blue Protection Covers - BCW

Feature:

- Use these covers to protect all weld ends on fittings and valves.

Size	Vinyl Plastic	
	Part #	Price/E
1/2"	<b>BCW-050</b>	<b>\$0.41</b>
3/4"	<b>BCW-075</b>	<b>0.70</b>
1"	<b>BCW-100</b>	<b>0.95</b>
1 1/2"	<b>BCW-150</b>	<b>1.18</b>
2"	<b>BCW-200</b>	<b>1.43</b>
2 1/2"	<b>BCW-250</b>	<b>2.13</b>
3"	<b>BCW-300</b>	<b>2.49</b>
4"	<b>BCW-400</b>	<b>3.92</b>
6"	<b>BCW-600</b>	<b>12.96</b>
8"	<b>BCW-800</b>	<b>23.27</b>

Unpolished Elbows

Unpolished 90° Weld Elbows with Tangents - B2S

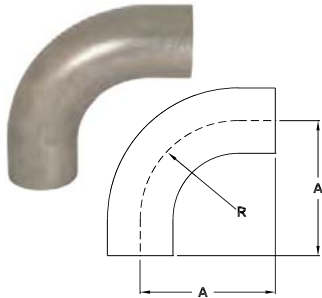

Tube OD	Dimensions		Wall Thickness	unpolished 304 Stainless Steel		unpolished 316L Stainless Steel	
	A	R		Part #	Price/E	Part #	Price/E
3/4"	3.000"	1.125"	.065"	---	---	<b>B2S-R75U</b>	<b>\$40.96</b>
1"	2.062"	1.500"	.065"	<b>B2S-G100U</b>	<b>\$11.86</b>	<b>B2S-R100U</b>	<b>13.58</b>
1 1/2"	2.937"	2.250"	.065"	<b>B2S-G150U</b>	<b>19.02</b>	<b>B2S-R150U</b>	<b>23.40</b>
2"	4.062"	3.000"	.065"	<b>B2S-G200U</b>	<b>29.21</b>	<b>B2S-R200U</b>	<b>37.37</b>
2 1/2"	5.187"	3.750"	.065"	<b>B2S-G250U</b>	<b>41.45</b>	<b>B2S-R250U</b>	<b>55.71</b>
3"	6.312"	4.500"	.065"	<b>B2S-G300U</b>	<b>64.56</b>	<b>B2S-R300U</b>	<b>81.60</b>
4"	8.312"	6.000"	.083"	<b>B2S-G400U</b>	<b>118.90</b>	<b>B2S-R400U</b>	<b>108.03</b>

Unpolished 90° Weld Elbows - B2WCL

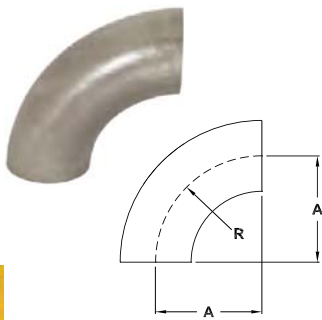

Tube OD	Dimensions		Wall Thickness	unpolished 304 Stainless Steel		unpolished 316L Stainless Steel	
	A	R		Part #	Price/E	Part #	Price/E
1/2"	1.125"	1.125"	.065"	---	---	<b>B2WCL-R50U</b>	<b>\$16.60</b>
3/4"	1.125"	1.125"	.065"	---	---	<b>B2WCL-R75U</b>	<b>16.93</b>
1"	1.500"	1.500"	.065"	<b>B2WCL-G100U</b>	<b>\$7.42</b>	<b>B2WCL-R100U</b>	<b>8.47</b>
1 1/2"	2.250"	2.250"	.065"	<b>B2WCL-G150U</b>	<b>12.24</b>	<b>B2WCL-R150U</b>	<b>14.94</b>
2"	3.000"	3.000"	.065"	<b>B2WCL-G200U</b>	<b>19.02</b>	<b>B2WCL-R200U</b>	<b>23.77</b>
2 1/2"	3.750"	3.750"	.065"	<b>B2WCL-G250U</b>	<b>25.18</b>	<b>B2WCL-R250U</b>	<b>33.97</b>
3"	4.500"	4.500"	.065"	<b>B2WCL-G300U</b>	<b>37.37</b>	<b>B2WCL-R300U</b>	<b>47.56</b>
4"	6.000"	6.000"	.083"	<b>B2WCL-G400U</b>	<b>78.14</b>	<b>B2WCL-R400U</b>	<b>57.80</b>
6"	9.000"	9.000"	.109"	<b>B2WCL-G600U</b>	<b>320.50</b>	<b>B2WCL-R600U</b>	<b>441.66</b>
8"	12.000"	12.000"	.120"	<b>B2WCL-G800U</b>	<b>577.82</b>	<b>B2WCL-R800U</b>	<b>781.42</b>

Unpolished 45° Long Weld Elbows with Tangents - B2KS

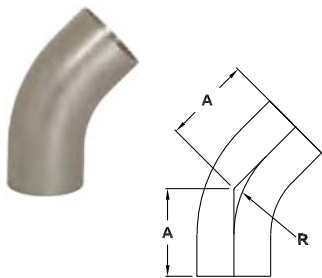

Tube OD	Dimensions		Wall Thickness	unpolished 304 Stainless Steel		unpolished 316L Stainless Steel	
	A	R		Part #	Price/E	Part #	Price/E
3/4"	2.250"	1.125"	.065"	---	---	<b>B2KS-R75U</b>	<b>\$40.06</b>
1"	1.188"	1.500"	.065"	<b>B2KS-G100U</b>	<b>\$11.60</b>	<b>B2KS-R100U</b>	<b>13.60</b>
1 1/2"	1.625"	2.250"	.065"	<b>B2KS-G150U</b>	<b>16.29</b>	<b>B2KS-R150U</b>	<b>26.28</b>
2"	2.312"	3.000"	.065"	<b>B2KS-G200U</b>	<b>25.13</b>	<b>B2KS-R200U</b>	<b>31.93</b>
2 1/2"	3.000"	3.750"	.065"	<b>B2KS-G250U</b>	<b>34.65</b>	<b>B2KS-R250U</b>	<b>49.60</b>
3"	3.688"	4.500"	.065"	<b>B2KS-G300U</b>	<b>50.28</b>	<b>B2KS-R300U</b>	<b>68.19</b>
4"	4.812"	6.000"	.083"	<b>B2KS-G400U</b>	<b>47.03</b>	<b>B2KS-R400U</b>	<b>57.80</b>

Unpolished Elbows

Unpolished 45° Weld Elbows - B2WK

Tube OD	Dimensions		Wall Thickness	unpolished 304 Stainless Steel		unpolished 316L Stainless Steel	
	A	R		Part #	Price/E	Part #	Price/E
¾"	.466"	1.125"	.065"	---	---	<b>B2WK-R75U</b>	<b>\$18.33</b>
1"	.625"	1.500"	.065"	<b>B2WK-G100U</b>	<b>\$9.90</b>	<b>B2WK-R100U</b>	<b>6.80</b>
1½"	.937"	2.250"	.065"	<b>B2WK-G150U</b>	<b>8.85</b>	<b>B2WK-R150U</b>	<b>10.58</b>
2"	1.250"	3.000"	.065"	<b>B2WK-G200U</b>	<b>13.58</b>	<b>B2WK-R200U</b>	<b>17.70</b>
2½"	1.562"	3.750"	.065"	<b>B2WK-G250U</b>	<b>20.45</b>	<b>B2WK-R250U</b>	<b>27.18</b>
3"	1.875"	4.500"	.065"	<b>B2WK-G300U</b>	<b>25.84</b>	<b>B2WK-R300U</b>	<b>35.59</b>
4"	2.500"	6.000"	.083"	<b>B2WK-G400U</b>	<b>54.36</b>	<b>B2WK-R400U</b>	<b>46.12</b>
6"	3.750"	9.000"	.109"	<b>B2WK-G600U</b>	<b>279.72</b>	<b>B2WK-R600U</b>	<b>352.56</b>
8"	5.000"	12.000"	.120"	<b>B2WK-G800U</b>	<b>451.64</b>	<b>B2WK-R800U</b>	<b>577.56</b>

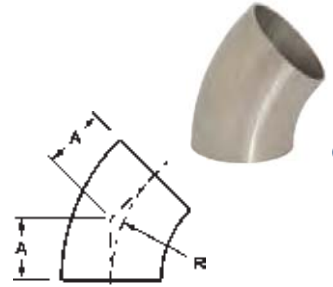

Pipe, Welding & Tube Fittings

Unpolished End Caps - B16W

Tube OD	Dimension A	unpolished 304 Stainless Steel	
		Part #	Price/E
1"	.375"	<b>B16W-G100</b>	<b>\$10.29</b>
1½"	.562"	<b>B16W-G150</b>	<b>12.35</b>
2"	.750"	<b>B16W-G200</b>	<b>21.55</b>
2½"	1.000"	<b>B16W-G250</b>	<b>26.41</b>
3"	1.250"	<b>B16W-G300</b>	<b>33.82</b>
4"	1.500"	<b>B16W-G400</b>	<b>56.38</b>

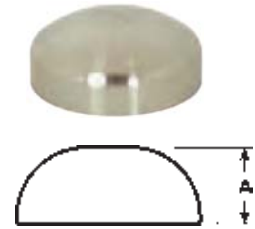

Unpolished Adapters

Male NPT x Weld End Adapters - B19WB

Tube OD	Dimension A	Wall Thickness	304 Stainless Steel	
			Part #	Price/E
1"	1.750"	.065"	<b>B19WB-G100</b>	<b>\$22.02</b>
1½"	1.750"	.065"	<b>B19WB-G150</b>	<b>30.31</b>
2"	1.812"	.065"	<b>B19WB-G200</b>	<b>36.90</b>
2½"	2.312"	.065"	<b>B19WB-G250</b>	<b>58.13</b>
3"	2.500"	.065"	<b>B19WB-G300</b>	<b>77.50</b>
4"	2.562"	.083"	<b>B19WB-G400</b>	<b>142.02</b>

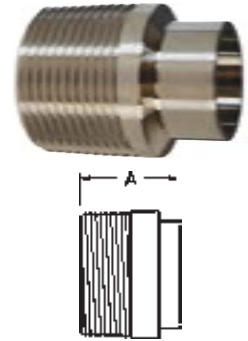

Female NPT x Weld End Adapters - B22WB

Tube OD	Dimension A	Wall Thickness	304 Stainless Steel	
			Part #	Price/E
1"	1.750"	.065"	<b>B22WB-G100</b>	<b>\$45.42</b>
1½"	1.750"	.065"	<b>B22WB-G150</b>	<b>47.70</b>
2"	1.812"	.065"	<b>B22WB-G200</b>	<b>56.91</b>
2½"	2.312"	.065"	<b>B22WB-G250</b>	<b>76.15</b>
3"	2.500"	.065"	<b>B22WB-G300</b>	<b>115.41</b>
4"	2.500"	.083"	<b>B22WB-G400</b>	<b>157.60</b>

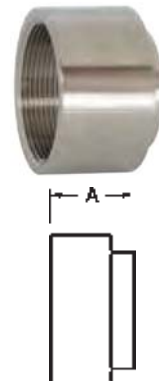

Unpolished Tees

Unpolished Short Weld Tees - B7WWW

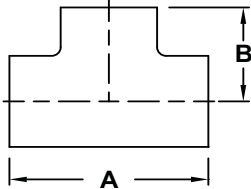

Tube OD	Dimensions		Wall Thickness	unpolished 304 Stainless Steel		unpolished 316L Stainless Steel	
	A	B		Part #	Price/E	Part #	Price/E
1"	2.250"	1.125"	.065"	<b>B7WWW-G100U</b>	<b>\$10.90</b>	<b>B7WWW-R100U</b>	<b>\$12.79</b>
1½"	3.312"	1.656"	.065"	<b>B7WWW-G150U</b>	<b>15.62</b>	<b>B7WWW-R150U</b>	<b>20.07</b>
2"	4.124"	2.062"	.065"	<b>B7WWW-G200U</b>	<b>22.41</b>	<b>B7WWW-R200U</b>	<b>29.66</b>
2½"	4.688"	2.344"	.065"	<b>B7WWW-G250U</b>	<b>29.88</b>	<b>B7WWW-R250U</b>	<b>44.47</b>
3"	5.188"	2.594"	.065"	<b>B7WWW-G300U</b>	<b>40.79</b>	<b>B7WWW-R300U</b>	<b>52.66</b>
4"	6.876"	3.438"	.083"	<b>B7WWW-G400U</b>	<b>48.67</b>	<b>B7WWW-R400U</b>	<b>57.05</b>

Unpolished Long Weld Tees - B7W

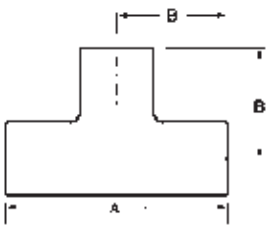

Tube OD	Dimensions		Wall Thickness	unpolished 304 Stainless Steel		unpolished 316L Stainless Steel	
	A	B		Part #	Price/E	Part #	Price/E
¾"	4.000"	2.000"	.065"	---	---	<b>B7W-R75U</b>	<b>\$29.66</b>
1"	3.750"	1.875"	.065"	<b>B7W-G100U</b>	<b>\$14.83</b>	<b>B7W-R100U</b>	<b>17.76</b>
1½"	4.500"	2.250"	.065"	<b>B7W-G150U</b>	<b>20.78</b>	<b>B7W-R150U</b>	<b>24.48</b>
2"	6.000"	3.000"	.065"	<b>B7W-G200U</b>	<b>29.90</b>	<b>B7W-R200U</b>	<b>40.03</b>
2½"	6.000"	3.000"	.065"	<b>B7W-G250U</b>	<b>38.54</b>	<b>B7W-R250U</b>	<b>61.15</b>
3"	6.500"	3.250"	.065"	<b>B7W-G300U</b>	<b>51.91</b>	<b>B7W-R300U</b>	<b>62.25</b>
4"	7.750"	3.875"	.083"	<b>B7W-G400U</b>	<b>63.97</b>	<b>B7W-R400U</b>	<b>62.66</b>

Unpolished Reducing Weld Tees - B7RWWW



Tube OD	Wall Thickness	unpolished 304 Stainless Steel		unpolished 316L Stainless Steel	
		Part #	Price/E	Part #	Price/E
1½" x 1"	.065"	<b>B7RWWW-G150100U</b>	<b>\$18.60</b>	<b>B7RWWW-R150100U</b>	<b>\$26.02</b>
2" x 1"	.065"	<b>B7RWWW-G200100U</b>	<b>26.71</b>	<b>B7RWWW-R200100U</b>	<b>31.88</b>
2" x 1½"	.065"	<b>B7RWWW-G200150U</b>	<b>27.48</b>	<b>B7RWWW-R200150U</b>	<b>31.88</b>
2½" x 1½"	.065"	<b>B7RWWW-G250150U</b>	<b>34.13</b>	<b>B7RWWW-R250150U</b>	<b>48.25</b>
2½" x 2"	.065"	<b>B7RWWW-G250200U</b>	<b>34.13</b>	<b>B7RWWW-R250200U</b>	<b>42.31</b>
3" x 1½"	.065"	<b>B7RWWW-G300150U</b>	<b>48.96</b>	<b>B7RWWW-R300150U</b>	<b>57.13</b>
3" x 2"	.065"	<b>B7RWWW-G300200U</b>	<b>48.96</b>	<b>B7RWWW-R300200U</b>	<b>57.84</b>
4" x 2"	.083"	<b>B7RWWW-G400200U</b>	<b>63.97</b>	<b>B7RWWW-R400200U</b>	<b>75.19</b>
4" x 3"	.083"	<b>B7RWWW-G400300U</b>	<b>63.97</b>	<b>B7RWWW-R400300U</b>	<b>75.19</b>

Dimensions

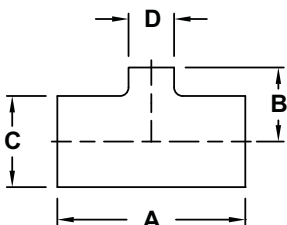

A	B	C	D
3.312"	1.375"	1.500"	1.000"
4.124"	1.625"	2.000"	1.000"
4.124"	1.906"	2.000"	1.500"
4.688"	2.156"	2.500"	1.500"
4.688"	2.312"	2.500"	2.000"
5.188"	2.406"	3.000"	1.500"
5.188"	2.562"	3.000"	2.000"
6.876"	3.062"	4.000"	2.000"
6.876"	3.094"	4.000"	3.000"

## Unpolished Weld Reducers

### Unpolished Concentric Weld Reducers - B31W

Tube OD	Dimension A	Wall Thickness	unpolished 304 Stainless Steel		unpolished 316L Stainless Steel	
			Part #	Price/E	Part #	Price/E
3/4" x 1/2"	1.000"	.065"	---	---	<b>B31W-R7550U</b>	<b>\$22.23</b>
1" x 1/2"	2.000"	.065"	---	---	<b>B31W-R10050U</b>	<b>34.77</b>
1" x 3/4"	1.000"	.065"	---	---	<b>B31W-R10075U</b>	<b>22.23</b>
1 1/2" x 3/4"	3.000"	.065"	---	---	<b>B31W-R15075U</b>	<b>32.59</b>
1 1/2" x 1"	2.000"	.065"	<b>B31W-G150100U</b>	<b>\$19.27</b>	<b>B31W-R150100U</b>	<b>20.76</b>
2" x 1"	4.000"	.065"	<b>B31W-G200100U</b>	<b>40.76</b>	<b>B31W-R200100U</b>	<b>48.96</b>
2" x 1 1/2"	2.000"	.065"	<b>B31W-G200150U</b>	<b>21.50</b>	<b>B31W-R200150U</b>	<b>23.71</b>
2 1/2" x 1 1/2"	4.000"	.065"	<b>B31W-G250150U</b>	<b>48.19</b>	<b>B31W-R250150U</b>	<b>51.89</b>
2 1/2" x 2"	2.000"	.065"	<b>B31W-G250200U</b>	<b>24.46</b>	<b>B31W-R250200U</b>	<b>28.90</b>
3" x 1 1/2"	6.000"	.065"	<b>B31W-G300150U</b>	<b>82.89</b>	<b>B31W-R300150U</b>	<b>92.72</b>
3" x 2"	4.000"	.065"	<b>B31W-G300200U</b>	<b>39.81</b>	<b>B31W-R300200U</b>	<b>46.93</b>
3" x 2 1/2"	2.000"	.065"	<b>B31W-G300250U</b>	<b>31.28</b>	<b>B31W-R300250U</b>	<b>35.59</b>
4" x 2"	8.000"	.083"	<b>B31W-G400200U</b>	<b>107.48</b>	<b>B31W-R400200U</b>	<b>114.20</b>
4" x 2 1/2"	6.000"	.083"	<b>B31W-G400250U</b>	<b>89.02</b>	<b>B31W-R400250U</b>	<b>103.85</b>
4" x 3"	4.000"	.083"	<b>B31W-G400300U</b>	<b>41.37</b>	<b>B31W-R400300U</b>	<b>59.79</b>
6" x 4"	5.500"	.109"	<b>B31W-G600400U</b>	<b>203.99</b>	<b>B31W-R600400U</b>	<b>259.58</b>

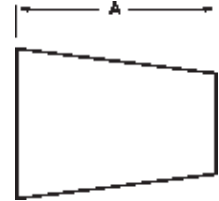

### Unpolished Eccentric Weld Reducers - B32W

Tube OD	Dimension A	Wall Thickness	unpolished 304 Stainless Steel		unpolished 316L Stainless Steel	
			Part #	Price/E	Part #	Price/E
1" x 1/2"	2.000"	.065"	---	---	<b>B32W-R10050U</b>	<b>\$46.71</b>
2" x 1"	4.000"	.065"	<b>B32W-G200100U</b>	<b>\$53.36</b>	<b>B32W-R200100U</b>	<b>57.84</b>
2" x 1 1/2"	2.000"	.065"	<b>B32W-G200150U</b>	<b>30.39</b>	<b>B32W-R200150U</b>	<b>32.62</b>
2 1/2" x 2"	2.000"	.065"	<b>B32W-G250200U</b>	<b>36.36</b>	<b>B32W-R250200U</b>	<b>37.06</b>
3" x 2"	4.000"	.065"	<b>B32W-G300200U</b>	<b>61.84</b>	<b>B32W-R300200U</b>	<b>66.72</b>
3" x 2 1/2"	2.000"	.065"	<b>B32W-G300250U</b>	<b>48.96</b>	<b>B32W-R300250U</b>	<b>48.25</b>
4" x 2"	8.000"	.083"	<b>B32W-G400200U</b>	<b>133.42</b>	<b>B32W-R400200U</b>	<b>137.20</b>
4" x 3"	4.000"	.083"	<b>B32W-G400300U</b>	<b>63.20</b>	<b>B32W-R400300U</b>	<b>74.19</b>

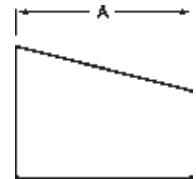

## Unpolished Type A Stub Ends - 14VB

### Application:

- typically used with B38SL flanges

Tube OD	Dimensions				316L Stainless Steel	
	A	B	C	D	Part #	Price/E
1"	1.625"	2.000"	1.000"	.065"	<b>14VB-R100</b>	<b>\$48.25</b>
1 1/2"	1.750"	2.875"	1.500"	.065"	<b>14VB-R150</b>	<b>74.75</b>
2"	1.500"	3.625"	2.000"	.065"	<b>14VB-R200</b>	<b>112.79</b>
2 1/2"	2.000"	4.125"	2.500"	.065"	<b>14VB-R250</b>	<b>149.49</b>
3"	2.250"	5.000"	3.000"	.065"	<b>14VB-R300</b>	<b>183.46</b>
4"	2.625"	6.187"	4.000"	.084"	<b>14VB-R400</b>	<b>298.97</b>
6"	3.000"	8.500"	6.000"	.109"	<b>14VB-R600</b>	<b>787.85</b>
8"	3.000"	10.625"	8.000"	.120"	<b>14VB-R800</b>	<b>740.38</b>

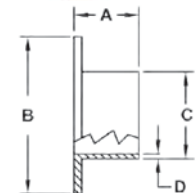



**Unpolished Miscellaneous Configurations**

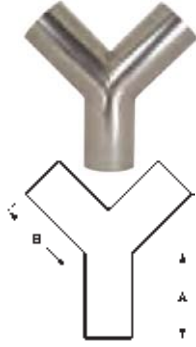

**Unpolished Weld True Wyes - B28W**

Tube OD	Dimensions		Wall Thickness	unpolished 316L Stainless Steel	
	A	B		Part #	Price/E
1"	2.000"	2.438"	.065"	<b>B28W-R100U</b>	<b>\$351.12</b>
1½"	2.000"	2.438"	.065"	<b>B28W-R150U</b>	<b>155.00</b>
2"	2.625"	3.250"	.065"	<b>B28W-R200U</b>	<b>378.24</b>
2½"	3.370"	4.125"	.065"	<b>B28W-R250U</b>	<b>660.79</b>
3"	4.000"	4.875"	.065"	<b>B28W-R300U</b>	<b>489.08</b>
4"	5.375"	5.375"	.083"	<b>B28W-R400U</b>	<b>319.95</b>

**Unpolished Weld Laterals - B28WA**

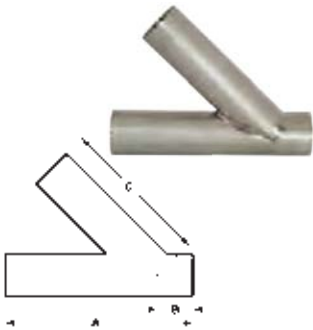

Tube OD	Dimensions			Wall Thickness	unpolished 316L Stainless Steel	
	A	B	R		Part #	Price/E
1"	6.000"	1.000"	5.000"	.065"	<b>B28WA-R100U</b>	<b>\$397.82</b>
1½"	7.375"	1.188"	6.188"	.065"	<b>B28WA-R150U</b>	<b>460.24</b>
2"	8.750"	1.625"	7.125"	.065"	<b>B28WA-R200U</b>	<b>192.52</b>
2½"	10.000"	1.500"	8.500"	.065"	<b>B28WA-R250U</b>	<b>378.16</b>
3"	10.750"	1.875"	8.875"	.065"	<b>B28WA-R300U</b>	<b>387.69</b>
4"	12.812"	2.015"	10.750"	.083"	<b>B28WA-R400U</b>	<b>319.95</b>

**Unpolished Weld 180° Return Bends - B2WUL**

**Feature:**

- bends are standard 1.5 x tube diameter



Tube OD	Dimensions		Wall Thickness	unpolished 316L Stainless Steel	
	A	B		Part #	Price/E
1"	3.000"	2.000"	.065"	<b>B2WUL-R100U</b>	<b>\$43.91</b>
1½"	4.500"	3.000"	.065"	<b>B2WUL-R150U</b>	<b>60.12</b>
2"	6.000"	4.000"	.065"	<b>B2WUL-R200U</b>	<b>76.76</b>
3"	9.000"	6.000"	.065"	<b>B2WUL-R300U</b>	<b>174.25</b>
4"	12.000"	8.000"	.083"	<b>B2WUL-R400U</b>	<b>292.06</b>

See page J-176 for weld end protection covers.



Flanges

Unpolished Slip-On 150# Flanges - B38SL

Tube OD	Dimensions			Number / Diameter Bolt Holes	Bolt Circle	304 Stainless Steel		316L Stainless Steel	
	A	B	C			Part #	Price/E	Part #	Price/E
1"	.375"	4.250"	1.063"	4/.625"	3.125"	<b>B38SL-G100</b>	<b>\$53.86</b>	<b>B38SL-R100</b>	<b>\$62.03</b>
1½"	.375"	5.000"	1.563"	4/.625"	3.875"	<b>B38SL-G150</b>	<b>64.18</b>	<b>B38SL-R150</b>	<b>74.63</b>
2"	.437"	6.000"	2.063"	4/.750"	4.750"	<b>B38SL-G200</b>	<b>86.75</b>	<b>B38SL-R200</b>	<b>101.56</b>
3"	.500"	7.500"	3.063"	4/.750"	6.000"	<b>B38SL-G300</b>	<b>136.25</b>	<b>B38SL-R300</b>	<b>166.29</b>
4"	.562"	9.000"	4.063"	8/.750"	7.500"	<b>B38SL-G400</b>	<b>181.73</b>	<b>B38SL-R400</b>	<b>225.42</b>
6"	.562"	11.000"	6.063"	8/.875"	9.500"	<b>B38SL-G600</b>	<b>244.52</b>	<b>B38SL-R600</b>	<b>296.93</b>
8"	.687"	13.500"	8.063"	8/.875"	11.750"	<b>B38SL-G800</b>	<b>747.79</b>	<b>B38SL-R800</b>	<b>951.73</b>

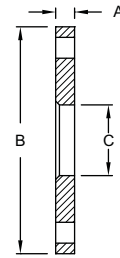

Pipe, Welding & Tube Fittings

Unpolished Weld Neck Flanges - B38W

Tube OD	Dimensions				Number / Diameter Bolt Holes	Bolt Circle	316L Stainless Steel	
	A	B	C	D			Part #	Price/E
1"	.375"	4.250"	1.000"	.500"	4/.625"	3.125"	<b>B38W-R100</b>	<b>\$224.36</b>
1½"	.375"	5.000"	1.500"	.500"	4/.625"	3.875"	<b>B38W-R150</b>	<b>263.27</b>
2"	.500"	6.000"	2.000"	.625"	4/.750"	4.750"	<b>B38W-R200</b>	<b>390.54</b>
2½"	.500"	7.000"	2.500"	.625"	4/.750"	5.500"	<b>B38W-R250</b>	<b>526.35</b>
3"	.500"	7.500"	3.000"	.625"	4/.750"	6.000"	<b>B38W-R300</b>	<b>623.93</b>
4"	.500"	9.000"	4.000"	.625"	8/.750"	7.500"	<b>B38W-R400</b>	<b>811.69</b>
6"	.500"	11.000"	6.000"	.625"	8/.875"	9.500"	<b>B38W-R600</b>	<b>2562.00</b>
8"	.500"	13.500"	8.000"	.625"	8/.875"	11.750"	<b>B38W-R800</b>	<b>3519.80</b>

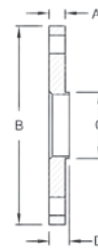

- For flange dimensions, diagrams and additional information please reference [dixonvalve.com](http://dixonvalve.com).



Spray Balls

Rotating Spray Balls - SRH

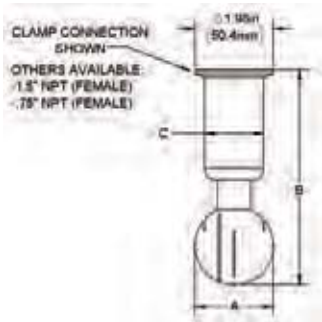

**Application:**

- ideal for cleaning all types of tanks and vessels

**Features:**

- stainless steel ball bearings eliminate rust
- cleaning solution lubricates unit
- mirror-like finish (OD)
- spray pattern: 360°
- available connections: clamp and NPT

Size	Type	304 Stainless Steel		316L Stainless Steel	
		Part #	Price/E	Part #	Price/E
3/4"	NPT	<b>SRH360NPT-G075</b>	<b>\$144.04</b>	---	---
1 1/2"	NPT	---	---	<b>SRH360NPT-R150</b>	<b>\$315.52</b>
1 1/2"	clamp	<b>SRH360CMP-G150</b>	<b>153.64</b>	<b>SRH360CMP-R150</b>	<b>207.41</b>

Stationary Spray Balls - STC

**Application:**

- typically used in food and beverage industries for cleaning storage tanks

**Features:**

- heavy duty 316L stainless steel construction provides longer life
- stationary - designed to be mounted to a tube or pipe
- 2 mm spray holes
- various spray patterns available (blanks available as special order)

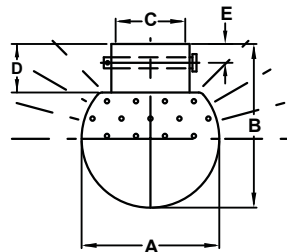

180° Top Pattern

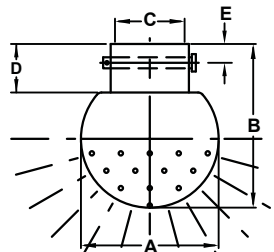

180° Bottom Pattern

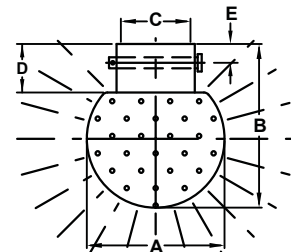

360° Pattern

Size	Pin Length	Spray Pattern	Dimensions					Pin Size	316L Stainless Steel	
			A	B	C	D	E		Part #	Price/E
1"	1.47"	360°	3.04"	2.95"	1.005"	.975"	.445"	.226"	<b>STC-360-R100</b>	<b>\$123.92</b>
1 1/2"	1.95"	360°	3.54"	2.95"	1.505"	.975"	.445"	.226"	<b>STC-360-R150</b>	<b>191.14</b>
1"	1.47"	180° bottom	3.54"	2.95"	1.005"	.975"	.445"	.226"	<b>STC-180B-R100</b>	<b>126.11</b>
1 1/2"	1.95"	180° bottom	3.54"	2.95"	1.505"	.975"	.445"	.226"	<b>STC-180B-R150</b>	<b>180.17</b>
1"	1.47"	180° top	3.54"	2.95"	1.005"	.975"	.445"	.226"	<b>STC-180T-R100</b>	<b>126.11</b>
1 1/2"	1.95"	180° top	3.54"	2.95"	1.505"	.975"	.445"	.226"	<b>STC-180T-R150</b>	<b>180.17</b>

Repair Kits

Repair kit contains:

- (1) pin
- (1) R clip

Size	Part #	Price/E
1"	<b>STC-RK100</b>	<b>\$9.04</b>
1 1/2"	<b>STC-RK150</b>	<b>9.22</b>

## Sight Glasses

## Features:

- size range: 1" - 6" OD tube
- finish: 32R<sub>a</sub> sanitary finish, ID and OD

## In-Line Sight Glasses - B54BMP

## Features:

- clamp, weld, bevel seat, John Perry, I-Line and Q-Line configurations are available
- maximum temperature: **200°F (93°C)**

Tube OD	Dimensions		Working Pressure PSI	316L Stainless Steel	
	A	B		Part #	Price/E
1"	5.625"	3.250"	<b>145</b>	<b>B54BMP-R100</b>	<b>\$573.46</b>
1½"	5.625"	4.000"	<b>145</b>	<b>B54BMP-R150</b>	<b>651.08</b>
2"	5.625"	4.250"	<b>145</b>	<b>B54BMP-R200</b>	<b>689.97</b>
2½"	6.125"	4.750"	<b>120</b>	<b>B54BMP-R250</b>	<b>884.15</b>
3"	7.250"	5.500"	<b>120</b>	<b>B54BMP-R300</b>	<b>1039.10</b>
4"	7.375"	6.500"	<b>95</b>	<b>B54BMP-R400</b>	<b>1243.51</b>
6"	7.625"	9.500"	<b>80</b>	<b>B54BMP-R600</b>	<b>6179.50</b>

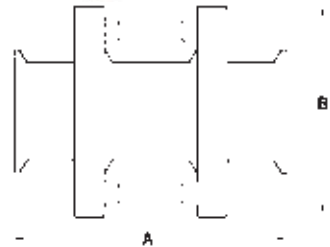
Pipe, Welding  
& Tube Fittings

## Seal Kit

Seal kit contains:

(2) black buna gaskets

Size	White Buna	
	Part #	Price/E
1"	<b>B54BMP-SK100</b>	<b>\$10.26</b>
1½"	<b>B54BMP-SK150</b>	<b>10.26</b>
2"	<b>B54BMP-SK200</b>	<b>10.26</b>
2½"	<b>B54BMP-SK250</b>	<b>13.81</b>
3"	<b>B54BMP-SK300</b>	<b>13.81</b>
4"	<b>B54BMP-SK400</b>	<b>13.81</b>
6"	<b>B54BMP-SK600</b>	<b>POR</b>



## Replacement Glass

Size	Borosilicate glass	
	Part #	Price/E
1"	<b>B54G-P100</b>	<b>\$284.22</b>
1½"	<b>B54G-P150</b>	<b>329.94</b>
2"	<b>B54G-P200</b>	<b>351.66</b>
2½"	<b>B54G-P250</b>	<b>451.49</b>
3"	<b>B54G-P300</b>	<b>534.29</b>
4"	<b>B54G-P400</b>	<b>635.08</b>
6"	<b>B54G-P600</b>	<b>POR</b>



## Sight Glass End Caps - B5416MP

## Features:

- for use on any line with a clamp and gasket
- maximum temperature: **150°F (66°C)**
- maximum operating pressure: **100 PSI**

Tube OD	Dimensions		Acrylic	
	A	B	Part #	Price/E
1" - 1½"	.438"	1.984"	<b>B5416MP-A100150</b>	<b>\$74.31</b>
2"	.438"	2.516"	<b>B5416MP-A200</b>	<b>131.80</b>
2½"	.438"	3.047"	<b>B5416MP-A250</b>	<b>123.85</b>
3"	.438"	3.579"	<b>B5416MP-A300</b>	<b>162.17</b>
4"	.438"	4.682"	<b>B5416MP-A400</b>	<b>326.92</b>
6"	.438"	6.562"	<b>B5416MP-A600</b>	<b>705.13</b>

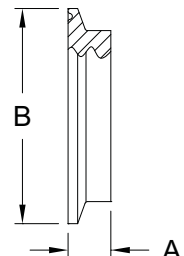

Compact Sight Glasses

**Applications:**

- Used widely in the food, dairy and beverage sanitary processes to view products and fluids.

**Features:**

- easier to clean than bolted styles
- less costly to repair than bolted styles
- clamp connections standard
- maximum temperature: **200°F (93°C)**
- maximum pressure: **100 PSI**

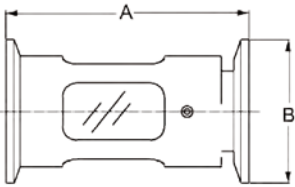

Tube OD	Dimensions		Borosilicate Glass	
	A	B	Part #	Price/E
1"	3.375"	1.980"	<b>B54BMPS-R100</b>	<b>\$156.16</b>
1½"	3.640"	1.980"	<b>B54BMPS-R150</b>	<b>236.92</b>
2"	3.830"	2.516"	<b>B54BMPS-R200</b>	<b>258.47</b>
3"	4.130"	3.800"	<b>B54BMPS-R300</b>	<b>443.60</b>
4"	4.340"	4.680"	<b>B54BMPS-R400</b>	<b>647.44</b>

Tube OD	Dimensions		Lexan™	
	A	B	Part #	Price/E
1"	3.375"	1.980"	<b>B54BMPLX-R100</b>	<b>\$231.32</b>
1½"	3.640"	1.980"	<b>B54BMPLX-R150</b>	<b>285.99</b>
2"	3.830"	2.516"	<b>B54BMPLX-R200</b>	<b>298.95</b>
3"	4.130"	3.800"	<b>B54BMPLX-R300</b>	<b>591.76</b>
4"	4.340"	4.680"	<b>B54BMPLX-R400</b>	<b>820.98</b>

**Seal Kits**



Size	Buna-N	
	Part #	Price/E
1"	<b>B54BMPS-SK100</b>	<b>\$10.26</b>
1½"	<b>B54BMPS-SK150</b>	<b>8.52</b>
2"	<b>B54BMPS-SK200</b>	<b>8.52</b>
3"	<b>B54BMPS-SK300</b>	<b>12.11</b>
4"	<b>B54BMPS-SK400</b>	<b>25.44</b>

**Replacement Glass**



Size	Borosilicate glass	
	Part #	Price/E
1"	<b>B54BMPS-GL100</b>	<b>\$60.90</b>
1½"	<b>B54BMPS-GL150</b>	<b>95.06</b>
2"	<b>B54BMPS-GL200</b>	<b>129.31</b>
3"	<b>B54BMPS-GL300</b>	<b>154.80</b>
4"	<b>B54BMPS-GL400</b>	<b>325.10</b>

## Swivels

## Features:

- available in clamp and weld configurations
- elastomers: silicone and PTFE standard, optional elastomers available
- finish: sanitary finish ID and OD

## straight swivel clamp - style 20

Size	Dimensions			Pressure Rating PSI @ 70°F (21°C)	Pressure Rating PSI @ 250°F (121°C)	316L Stainless Steel	
	A	B	C			Part #	Price/E
1"	2.56"	3.00"	1.00"	500	<b>300</b>	<i>SJSS100CC-20</i>	<b>\$1800.15</b>
1½"	2.56"	3.00"	1.50"	500	<b>300</b>	<i>SJSS150CC-20</i>	<b>1853.74</b>
2"	3.09"	3.00"	2.00"	450	<b>250</b>	<i>SJSS200CC-20</i>	<b>2156.87</b>
2½"	3.44"	3.00"	2.50"	400	<b>200</b>	<i>SJSS250CC-20</i>	<b>3824.20</b>
3"	3.94"	3.00"	3.00"	350	<b>175</b>	<i>SJSS300CC-20</i>	<b>4439.59</b>
4"	5.08"	4.19"	4.00"	300	<b>150</b>	<i>SJSS400CC-20</i>	<b>7974.76</b>

## straight weld connection - style 20

Size	Dimensions			Pressure Rating PSI @ 70°F (21°C)	Pressure Rating PSI @ 250°F (121°C)	316L Stainless Steel	
	A	B	C			Part #	Price/E
1"	2.56"	2.00"	1.00"	500	<b>300</b>	<i>SJSS100BB-20</i>	<b>\$1764.92</b>
1½"	2.56"	2.00"	1.50"	500	<b>300</b>	<i>SJSS150BB-20</i>	<b>2953.97</b>
2"	3.09"	2.00"	2.00"	450	<b>250</b>	<i>SJSS200BB-20</i>	<b>2038.08</b>
2½"	3.44"	2.00"	2.50"	400	<b>200</b>	<i>SJSS250BB-20</i>	<b>3008.10</b>
3"	3.94"	2.00"	3.00"	350	<b>175</b>	<i>SJSS300BB-20</i>	<b>4236.64</b>
4"	5.08"	2.94"	4.00"	300	<b>150</b>	<i>SJSS400BB-20</i>	<b>8473.63</b>

- dimensional information can be found at [dixonvalve.com](http://dixonvalve.com)

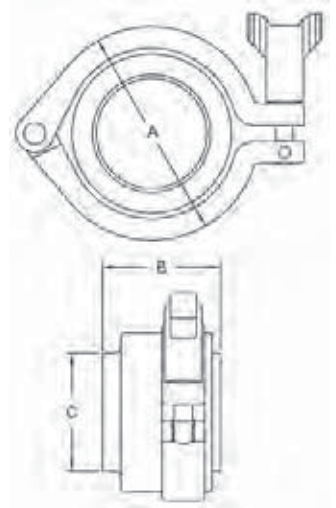
Pipe, Welding  
& Tube Fittings

Sanitary 3 1/2" Pressure Gauges

Features:

- accuracy: ± 1.5% of full scale
- over range capacity: 30%
- wetted surfaces: 316L stainless steel
- surface finishes (wetted parts): R<sub>a</sub> max = 25 microinches
- case material: 304 stainless steel
- dial size: 3 1/2"
- lens material: polycarbonate
- temperature range: 0°F (-18°C) to 250°F (121°C)
- standard fill: food grade glycerin
- rezero feature: standard on pointer
- shipping weight: approximately 3 lbs. (1.3 kg)

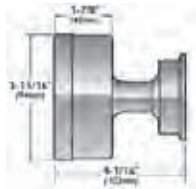
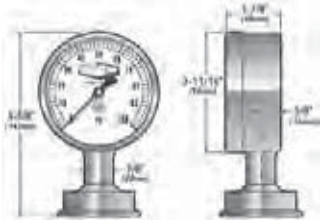

Dial Size	Clamp Size	Pressure Range (PSI)	Mount	316L Stainless Steel	
				Part #	Price/E
3 1/2"	1 1/2"	0-30	bottom	3S-B-15U-GFBTSS	\$1047.14
	1 1/2"	0-60	bottom	3S-C-15U-GFBTSS	1047.14
	1 1/2"	0-100	bottom	3S-D-15U-GFBTSS	1047.14
	1 1/2"	0-160	bottom	3S-E-15U-GFBTSS	1047.14
	1 1/2"	0-200	bottom	3S-F-15U-GFBTSS	1047.14
	1 1/2"	0-300	bottom	3S-G-15U-GFBTSS	1047.14
	1 1/2"	0-30	back	3S-B-15U-GFBKSS	1047.14
	1 1/2"	0-60	back	3S-C-15U-GFBKSS	1047.14
	1 1/2"	0-100	back	3S-D-15U-GFBKSS	1047.14
	1 1/2"	0-160	back	3S-E-15U-GFBKSS	1047.14
	1 1/2"	0-200	back	3S-F-15U-GFBKSS	1047.14
	1 1/2"	0-300	back	3S-G-15U-GFBKSS	1047.14
	2"	0-30	bottom	3S-B-2U-GFBTSS	1047.14
	2"	0-60	bottom	3S-C-2U-GFBTSS	1047.14
	2"	0-100	bottom	3S-D-2U-GFBTSS	1047.14
	2"	0-160	bottom	3S-E-2U-GFBTSS	1047.14
	2"	0-200	bottom	3S-F-2U-GFBTSS	1047.14
	2"	0-300	bottom	3S-G-2U-GFBTSS	1047.14
	2"	0-30	back	3S-B-2U-GFBKSS	1047.14
	2"	0-60	back	3S-C-2U-GFBKSS	1047.14
	2"	0-100	back	3S-D-2U-GFBKSS	1047.14
	2"	0-160	back	3S-E-2U-GFBKSS	1047.14
	2"	0-200	back	3S-F-2U-GFBKSS	1047.14
	2"	0-300	back	3S-G-2U-GFBKSS	1047.14





Strainers

In-line Strainer - BSCCQ

Features:

- ships standard with: spring, distributor cap, clamp gasket, 1/4" perforated back-up tube, squeeze clamp, inlet and outlet bodies
- must be vertically mounted to be 3A compliant
- bevel seat, I-line and weld ends available, call Dixon® for information
- 1/8" perforated back-up tube available, must specify when ordering (not 3A)

short

Size	Dimensions		316L Stainless Steel	
	A	B	Part #	Price/E
1"	15.75"	4.00"	<b>BSCCQ1-R100</b>	<b>\$1448.47</b>
1½"	15.75"	4.00"	<b>BSCCQ1-R150</b>	<b>1448.47</b>
2"	15.75"	4.00"	<b>BSCCQ1-R200</b>	<b>1448.47</b>
2½"	15.75"	4.50"	<b>BSCCS1-R250</b>	<b>1709.69</b>
3"	15.75"	4.50"	<b>BSCCS1-R300</b>	<b>1709.69</b>

long

Size	Dimensions		316L Stainless Steel	
	A	B	Part #	Price/E
1½"	35.375"	4.00"	<b>BSCCQ2-R150</b>	<b>\$2561.39</b>
2"	35.375"	4.00"	<b>BSCCQ2-R200</b>	<b>2561.39</b>
3"	35.375"	4.50"	<b>BSCCS2-R300</b>	<b>3129.94</b>



short



Pipe, Welding & Tube Fittings

Side-Entry Strainer - BSCCQ

Features:

- ships standard with: spring, end cap with handle, distributor cap, clamp gasket, 1/4" perforated back-up tube, body and squeeze clamp
- serviceable without removing from the line
- must be a vertically mounted to be 3A compliant
- bevel seat, I-line and weld ends available, call Dixon® for information
- 1/8" perforated back-up tube available, must specify when ordering (not 3A certified)

Size	Dimensions				316L Stainless Steel	
	A	B	C	D	Part #	Price/E
1½"	41.90"	4.00"	35.00"	3.50"	<b>BSCCQ3-R150</b>	<b>\$3322.92</b>
2"	41.90"	4.00"	35.00"	3.50"	<b>BSCCQ3-R200</b>	<b>3322.92</b>
3"	41.90"	4.50"	35.00"	3.75"	<b>BSCCQ3-R300</b>	<b>4092.37</b>

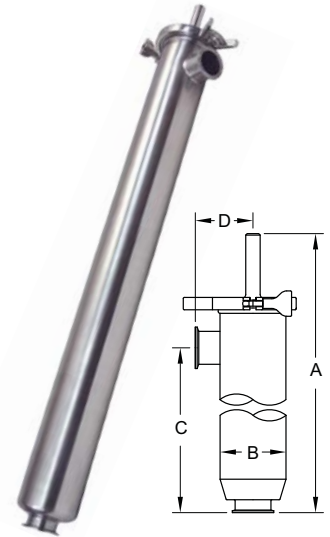

Side-Outlet Reverse Strainer - BSCCQ

Features:

- ships standard with: spring, end cap with handle, distributor cap, clamp gasket, 1/4" perforated back-up tube, body and squeeze clamp
- 1/8" perforated back-up tube available (not 3A certified)
- bevel seat, I-line and weld ends available, call Dixon® for information
- can be serviced in-line

Size	Dimensions				316L Stainless Steel	
	A	B	C	D	Part #	Price/E
1½"	41.90"	4.00"	35.00"	3.50"	<b>BSCCQ4-R150</b>	<b>\$3209.12</b>
2"	41.90"	4.00"	35.00"	3.50"	<b>BSCCQ4-R200</b>	<b>3209.12</b>
3"	41.90"	4.50"	35.00"	3.75"	<b>BSCCQ4-R300</b>	<b>3938.74</b>

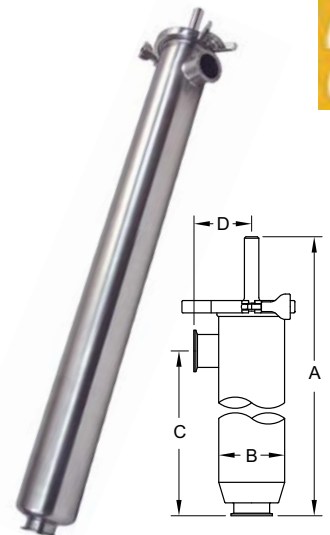

Strainers

Filters

Features:

- filter medium are special order and minimum quantities apply, not included with base unit
- filters require retaining ring

short

Size	Micron Rating	Description	Part #	Price/E
1" - 2"	38	nonwoven rayon (glued seam)	<b>BF30A-100-200</b>	<b>\$238.84</b>
2½" - 3"	38	nonwoven rayon (glued seam)	<b>BF30A-250-300</b>	<b>173.92</b>
1" - 2"	513	woven knapped cotton flannel	<b>BF30B-100-200</b>	<b>472.38</b>
2½" - 3"	513	woven knapped cotton flannel	<b>BF30B-250-300</b>	<b>455.85</b>
1" - 2"	300	cheese cloth, single thickness cotton	<b>BF30C-100-200</b>	<b>188.85</b>
2½" - 3"	300	cheese cloth, single thickness cotton	<b>BF30C-250-300</b>	<b>239.38</b>
1" - 2"	765	nylon, 26/29 mesh, rectangular opening, (.025 x .030)	<b>BF30D-100-200</b>	<b>387.31</b>
2½" - 3"	765	nylon, 26/29 mesh, rectangular opening, (.025 x .030)	<b>BF30D-250-300</b>	<b>387.62</b>
1" - 2"	40-42	nonwoven rayon	<b>BF30E-100-200</b>	<b>337.15</b>
2½" - 3"	40-42	nonwoven rayon	<b>BF30E-250-300</b>	<b>192.69</b>
1" - 2"	40	nonwoven rayon	<b>BF30F-100-200</b>	<b>295.77</b>
1" - 2"	420	woven nylon, 40 mesh	<b>BF30G-100-200</b>	<b>317.69</b>
2½" - 3"	420	woven nylon, 40 mesh	<b>BF30G-250-300</b>	<b>257.99</b>

long

Size	Micron Rating	Description	Part #	Price/E
1" - 2"	40-42	nonwoven rayon	<b>BF302E-100-200</b>	<b>\$473.84</b>
2½" - 3"	40-42	nonwoven rayon	<b>BF302E-250-300</b>	<b>823.65</b>
2½" - 3"	420	woven nylon, 40 mesh	<b>BF302G-250-300</b>	<b>398.92</b>

316 Stainless Wire Cloth Mesh Over Screens

Features:

- not all sizes are stocked, additional sizes are available (5 piece minimum), call Dixon®
- not 3A compatible, not included with base unit

Size	Micron Rating	Square Mesh	Space Between Wires	Percent of Open Area	Short Part #	Price/E	Long Part #	Price/E
1" - 2"	864	20	0.034"	46.2	<b>BS20-100-200</b>	<b>\$106.53</b>	<b>BS202-100-200</b>	<b>\$190.39</b>
2½" - 3"	864	20	0.034"	46.2	<b>BS20-250-300</b>	<b>111.92</b>	<b>BS202-250-300</b>	<b>198.47</b>
1" - 2"	381	40	0.015"	36.0	<b>BS40-100-200</b>	<b>106.53</b>	<b>BS402-100-200</b>	<b>190.39</b>
2½" - 3"	381	40	0.015"	36.0	<b>BS40-250-300</b>	<b>111.92</b>	<b>BS402-250-300</b>	<b>198.47</b>
1" - 2"	229	60	0.009"	30.3	<b>BS60-100-200</b>	<b>106.53</b>	<b>BS602-100-200</b>	<b>190.39</b>
2½" - 3"	229	60	0.009"	30.3	<b>BS60-250-300</b>	<b>111.92</b>	<b>BS602-250-300</b>	<b>198.47</b>
1" - 2"	178	80	0.007"	31.4	<b>BS80-100-200</b>	<b>106.53</b>	<b>BS802-100-200</b>	<b>190.39</b>
2½" - 3"	178	80	0.007"	31.4	<b>BS80-250-300</b>	<b>111.92</b>	<b>BS802-250-300</b>	<b>198.47</b>
1" - 2"	140	100	0.006"	30.3	<b>BS100-100-200</b>	<b>106.53</b>	<b>BS1002-100-200</b>	<b>190.39</b>
2½" - 3"	140	100	0.006"	30.3	<b>BS100-250-300</b>	<b>101.75</b>	<b>BS1002-250-300</b>	<b>198.47</b>

Pressure Drop Curves for Filter and Strainer

- water at ambient temperature
- maximum flow for short units is 125 GPM
- maximum flow for long units is 175 GPM

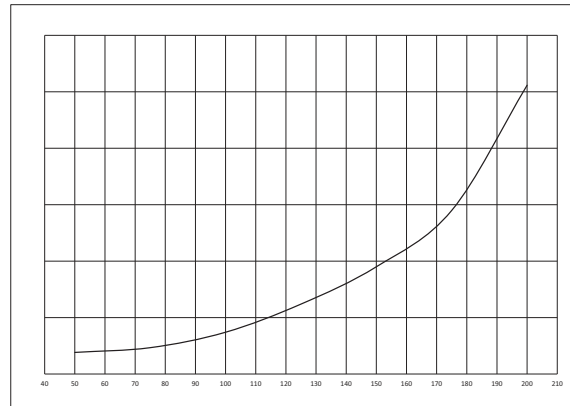
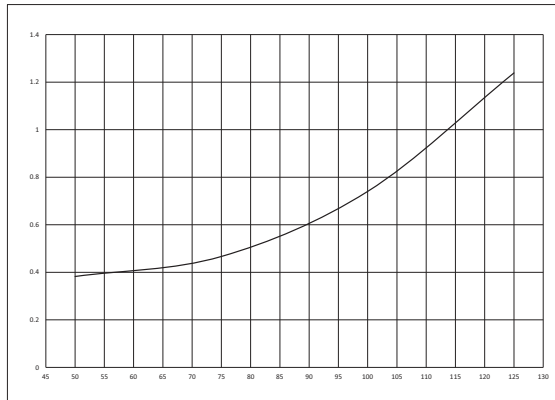

Tube Hangers

Hex Tube Hanger with ABS Sleeve - B24PS

Feature:

- maximum temperature: 230°F (110°C)

Tube OD	Dimensions		304 Stainless Steel	
	A	B	Part #	Price/E
1/2"	2.800"	1.150"	<b>B24PS-G50</b>	<b>\$9.26</b>
3/4"	2.800"	1.150"	<b>B24PS-G75</b>	<b>9.26</b>
1"	3.425"	1.450"	<b>B24PS-G100</b>	<b>12.93</b>
1 1/2"	4.000"	2.125"	<b>B24PS-G150</b>	<b>14.07</b>
2"	4.500"	2.500"	<b>B24PS-G200</b>	<b>16.89</b>
2 1/2"	4.950"	3.125"	<b>B24PS-G250</b>	<b>19.66</b>
3"	5.500"	3.750"	<b>B24PS-G300</b>	<b>22.41</b>
4"	6.950"	4.750"	<b>B24PS-G400</b>	<b>29.21</b>
5"	8.063"	5.625"	<b>B24PS-G500</b>	<b>92.88</b>
6"	9.250"	6.625"	<b>B24PS-G600</b>	<b>60.90</b>
8"	11.500"	8.625"	<b>B24PS-G800</b>	<b>106.81</b>

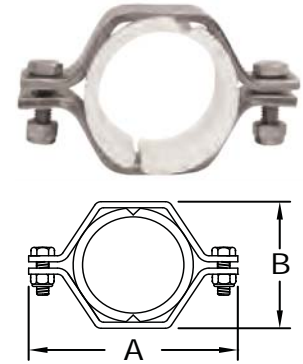

Pipe, Welding  
& Tube Fittings

Sleeves - 13PS

Features:

- maximum temperature: 230°F (110°C)
- high temperature sleeves are also available, contact Dixon®

Size	ABS	
	Part #	Price/E
1/2"	<b>13PS-50</b>	<b>\$4.19</b>
3/4"	<b>13PS-75</b>	<b>4.19</b>
1"	<b>13PS-100</b>	<b>4.69</b>
1 1/2"	<b>13PS-150</b>	<b>4.69</b>
2"	<b>13PS-200</b>	<b>4.69</b>
2 1/2"	<b>13PS-250</b>	<b>7.27</b>
3"	<b>13PS-300</b>	<b>7.75</b>
4"	<b>13PS-400</b>	<b>9.37</b>
5"	<b>13PS-500</b>	<b>60.90</b>
6"	<b>13PS-600</b>	<b>15.83</b>
8"	<b>13PS-800</b>	<b>22.94</b>



Hex Tube Hanger with Nitrile Grommets - B24RG

Features:

- replacement grommets are available, contact Dixon®
- nitrile grommets; maximum temperature: 230°F (110°C)

Tube OD	Dimensions		304 Stainless Steel	
	A	B	Part #	Price/E
1/2" - 3/4"	3.425"	1.450"	<b>B24RG-G75</b>	<b>\$11.58</b>
1"	3.425"	1.450"	<b>B24RG-G100</b>	<b>12.65</b>
1 1/2"	4.000"	2.125"	<b>B24RG-G150</b>	<b>13.60</b>
2"	4.500"	2.500"	<b>B24RG-G200</b>	<b>16.48</b>
2 1/2"	4.950"	3.125"	<b>B24RG-G250</b>	<b>18.58</b>
3"	5.500"	3.750"	<b>B24RG-G300</b>	<b>21.20</b>
4"	6.950"	4.750"	<b>B24RG-G400</b>	<b>27.46</b>
5"	8.000"	5.625"	<b>B24RG-G500</b>	<b>51.60</b>
6"	9.250"	6.625"	<b>B24RG-G600</b>	<b>47.38</b>
8"	11.500"	8.625"	<b>B24RG-G800</b>	<b>87.59</b>

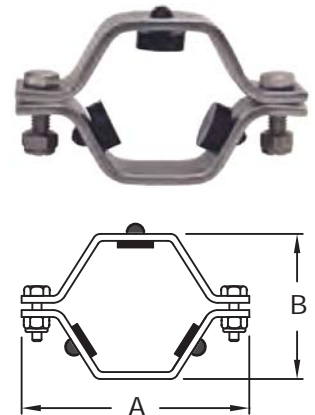

Tube Hangers

Round Tube Hangers with Nitrile Inserts - B24RPH

Feature:

- Nitrile inserts
- maximum temperature: 230°F (110°C)

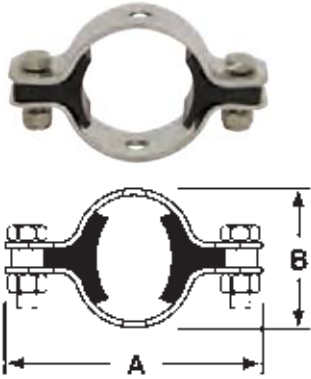

Tube OD	Dimensions		304 Stainless Steel	
	A	B	Part #	Price/E
1/2"	2.750"	1.125"	<b>B24RPH-G50</b>	<b>\$12.63</b>
3/4"	2.750"	1.125"	<b>B24RPH-G75</b>	<b>12.63</b>
1"	3.310"	1.500"	<b>B24RPH-G100</b>	<b>20.19</b>
1 1/2"	3.810"	2.000"	<b>B24RPH-G150</b>	<b>21.51</b>
2"	4.250"	2.562"	<b>B24RPH-G200</b>	<b>24.89</b>
2 1/2"	5.000"	3.000"	<b>B24RPH-G250</b>	<b>27.61</b>
3"	5.500"	3.562"	<b>B24RPH-G300</b>	<b>31.07</b>
4"	6.500"	4.688"	<b>B24RPH-G400</b>	<b>39.21</b>

Nuts and Bolts - 13NHN

Features:

- hex hangers with grommets and round hangers 1" to 4" use 13NHN-G100-600 fastener sets
- 1/2" and 3/4" round and sleeved hangers use 13NHN-G75 fastener sets
- 2 nuts and bolts supplied to a set



Size	Description	304 Stainless Steel	
		Part #	Price/E
1/2" - 3/4"	1/4"-20 x 3/4" bolt with nylock nut	<b>13NHN-G75</b>	<b>\$2.36</b>
1" - 12"	5/16"-18 x 1" bolt with nylock nut	<b>13NHN-G100-600</b>	<b>1.54</b>

Wall Flanges - B25

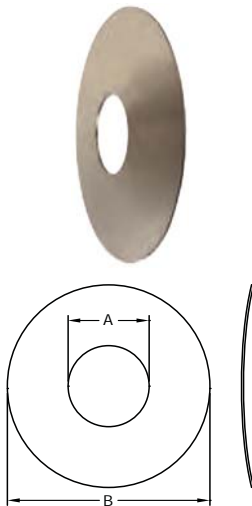

Tube OD	Dimensions		Wall Thickness	304 Stainless Steel	
	A	B		Part #	Price/E
1/2"	.50"	3.00"	.065"	<b>B25-G050300</b>	<b>\$30.64</b>
1/2"	.50"	5.00"	.065"	<b>B25-G050500</b>	<b>32.05</b>
3/4"	.75"	3.00"	.065"	<b>B25-G075300</b>	<b>27.95</b>
3/4"	.75"	5.00"	.065"	<b>B25-G075500</b>	<b>33.65</b>
1"	1.00"	3.00"	.065"	<b>B25-G100300</b>	<b>25.38</b>
1"	1.00"	5.00"	.065"	<b>B25-G100500</b>	<b>28.43</b>
1 1/2"	1.50"	5.00"	.065"	<b>B25-G150500</b>	<b>29.16</b>
2"	2.00"	5.00"	.065"	<b>B25-G200500</b>	<b>29.80</b>
2 1/2"	2.50"	5.00"	.065"	<b>B25-G250500</b>	<b>30.44</b>
3"	3.00"	6.00"	.065"	<b>B25-G300600</b>	<b>30.84</b>
4"	4.00"	7.00"	.065"	<b>B25-G400700</b>	<b>37.75</b>
6"	6.00"	10.00"	.065"	<b>B25-G6001000</b>	<b>161.80</b>
8"	8.00"	12.00"	.065"	<b>B25-G8001200</b>	<b>212.89</b>
10"	10.00"	14.00"	.065"	<b>B25-G10001400</b>	<b>256.67</b>
12"	12.00"	16.00"	.065"	<b>B25-G12001600</b>	<b>270.31</b>

High Purity BioPharm Fittings

63-03  
621

90° Weld Elbows - T2S

Size	Dimension A	PL finish - SF1		PM finish - SF4	
		Part #	Price/E	Part #	Price/E
1/2"	3.00"	T2S-050PL	\$43.01	T2S-050PM	\$58.46
3/4"	3.00"	T2S-075PL	38.98	T2S-075PM	54.50
1"	3.00"	T2S-100PL	36.54	T2S-100PM	65.46
1 1/2"	3.75"	T2S-150PL	45.25	T2S-150PM	65.46
2"	4.75"	T2S-200PL	57.95	T2S-200PM	80.07
2 1/2"	5.50"	T2S-250PL	84.04	T2S-250PM	117.31
3"	6.25"	T2S-300PL	121.79	T2S-300PM	158.72
4"	8.00"	T2S-400PL	229.48	T2S-400PM	270.38



BPE Table DT-4.1.1-1

90° Clamp x Weld Elbows - T2CM

Size	Dimensions		PL finish - SF1		PM finish - SF4	
	A	B	Part #	Price/E	Part #	Price/E
1/2"	3.00"	1.625"	T2CM-050PL	\$63.21	T2CM-050PM	\$81.73
3/4"	3.00"	1.625"	T2CM-075PL	58.33	T2CM-075PM	76.99
1"	3.00"	2.000"	T2CM-100PL	56.28	T2CM-100PM	78.47
1 1/2"	3.75"	2.750"	T2CM-150PL	64.42	T2CM-150PM	88.85
2"	4.75"	3.500"	T2CM-200PL	86.08	T2CM-200PM	112.05
2 1/2"	5.50"	4.250"	T2CM-250PL	119.10	T2CM-250PM	156.21
3"	6.25"	5.000"	T2CM-300PL	155.20	T2CM-300PM	195.89
4"	8.00"	6.625"	T2CM-400PL	258.65	T2CM-400PM	258.65

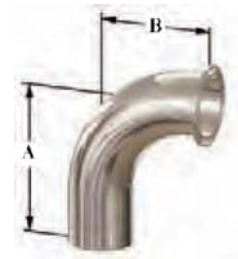

BPE Table DT-4.1.1-2

90° Clamp x Clamp Elbows - T2CMP

Size	Dimension A	PL finish - SF1		PM finish - SF4	
		Part #	Price/E	Part #	Price/E
1/2"	1.625"	T2CMP-050PL	\$67.95	T2CMP-050PM	\$90.97
3/4"	1.625"	T2CMP-075PL	68.52	T2CMP-075PM	91.61
1"	2.000"	T2CMP-100PL	67.11	T2CMP-100PM	92.25
1 1/2"	2.750"	T2CMP-150PL	73.21	T2CMP-150PM	102.11
2"	3.500"	T2CMP-200PL	98.91	T2CMP-200PM	129.49
2 1/2"	4.250"	T2CMP-250PL	129.49	T2CMP-250PM	170.96
3"	5.000"	T2CMP-300PL	169.11	T2CMP-300PM	214.10
4"	6.625"	T2CMP-400PL	248.01	T2CMP-400PM	297.82



BPE Table DT-4.11.1-3

45° Weld Elbows - T2KS

Size	Dimension A	PL finish - SF1		PM finish - SF4	
		Part #	Price/E	Part #	Price/E
1/2"	2.250"	T2KS-050PL	\$41.60	T2KS-050PM	\$57.12
3/4"	2.250"	T2KS-075PL	37.50	T2KS-075PM	53.14
1"	2.250"	T2KS-100PL	34.03	T2KS-100PM	52.05
1 1/2"	2.500"	T2KS-150PL	39.75	T2KS-150PM	60.00
2"	3.000"	T2KS-200PL	50.78	T2KS-200PM	73.14
2 1/2"	3.375"	T2KS-250PL	75.06	T2KS-250PM	108.53
3"	3.625"	T2KS-300PL	103.01	T2KS-300PM	140.58
4"	4.500"	T2KS-400PL	186.03	T2KS-400PM	228.27



BPE Table DT-4.1.1-4

PL Finish – SF1  
OD = 32R<sub>a</sub> Mechanically Polished  
ID = 20R<sub>a</sub> Mechanically Polished

PM Finish – SF4  
OD = 32R<sub>a</sub> Mechanically Polished  
ID = 15R<sub>a</sub> Mechanically Polished and Electropolished



High Purity BioPharm Fittings

45° Clamp x Weld Elbows - T2KM

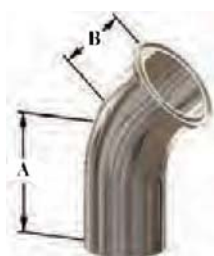

BPE Table DT-4.1.1-5

Size	Dimensions		PL finish - SF1		PM finish - SF4	
	A	B	Part #	Price/E	Part #	Price/E
1/2"	2.250"	1.000"	T2KM-050PL	\$57.95	T2KM-050PM	\$76.60
3/4"	2.250"	1.000"	T2KM-075PL	57.12	T2KM-075PM	75.83
1"	2.250"	1.125"	T2KM-100PL	56.08	T2KM-100PM	78.27
1 1/2"	2.500"	1.438"	T2KM-150PL	60.97	T2KM-150PM	85.45
2"	3.000"	1.750"	T2KM-200PL	79.55	T2KM-200PM	105.70
2 1/2"	3.375"	2.063"	T2KM-250PL	110.12	T2KM-250PM	147.49
3"	3.625"	2.380"	T2KM-300PL	140.32	T2KM-300PM	181.48
4"	4.500"	3.125"	T2KM-400PL	221.73	T2KM-400PM	267.63

45° Clamp x Clamp Elbows - T2KMP



BPE Table DT-4.1.1-6

Size	Dimension A	PL finish - SF1		PM finish - SF4	
		Part #	Price/E	Part #	Price/E
1/2"	1.000"	T2KMP-050PL	\$61.80	T2KMP-050PM	\$80.38
3/4"	1.000"	T2KMP-075PL	62.18	T2KMP-075PM	86.67
1"	1.125"	T2KMP-100PL	63.02	T2KMP-100PM	89.67
1 1/2"	1.438"	T2KMP-150PL	66.93	T2KMP-150PM	95.96
2"	1.750"	T2KMP-200PL	91.80	T2KMP-200PM	122.56
2 1/2"	2.063"	T2KMP-250PL	121.34	T2KMP-250PM	163.08
3"	2.380"	T2KMP-300PL	150.71	T2KMP-300PM	196.29
4"	3.125"	T2KMP-400PL	263.22	T2KMP-400PM	280.83

Weld x Weld x Weld Tees - T7WWW



BPE Table DT-4.1.2-1

Size	Dimensions		PL finish - SF1		PM finish - SF4	
	A	B	Part #	Price/E	Part #	Price/E
1/2"	3.750"	1.875"	T7WWW-050PL	\$50.96	T7WWW-050PM	\$66.16
3/4"	4.000"	2.000"	T7WWW-075PL	51.79	T7WWW-075PM	66.93
1"	4.250"	2.125"	T7WWW-100PL	44.48	T7WWW-100PM	62.18
1 1/2"	4.750"	2.375"	T7WWW-150PL	54.50	T7WWW-150PM	74.35
2"	5.750"	2.875"	T7WWW-200PL	65.70	T7WWW-200PM	87.56
2 1/2"	6.250"	3.125"	T7WWW-250PL	91.34	T7WWW-250PM	124.49
3"	6.750"	3.375"	T7WWW-300PL	113.40	T7WWW-300PM	150.57
4"	8.250"	4.125"	T7WWW-400PL	183.59	T7WWW-400PM	225.83

Weld x Weld x Weld Reducing Tees - T7RWWW



BPE Table DT-4.1.2-6

Size	Dimensions		PL finish - SF1		PM finish - SF4	
	A	B	Part #	Price/E	Part #	Price/E
3/4" x 1/2"	4.000"	2.000"	T7RWWW-075050PL	\$77.89	T7RWWW-075050PM	\$99.49
1" x 1/2"	4.250"	2.125"	T7RWWW-100050PL	77.30	T7RWWW-100050PM	103.52
1" x 3/4"	4.250"	2.125"	T7RWWW-100075PL	77.70	T7RWWW-100075PM	103.98
1 1/2" x 1/2"	4.750"	2.375"	T7RWWW-150050PL	89.74	T7RWWW-150050PM	120.57
1 1/2" x 3/4"	4.750"	2.375"	T7RWWW-150075PL	78.14	T7RWWW-150075PM	109.30
1 1/2" x 1"	4.750"	2.375"	T7RWWW-150100PL	68.34	T7RWWW-150100PM	99.82
2" x 1/2"	5.750"	2.625"	T7RWWW-200050PL	92.38	T7RWWW-200050PM	130.26
2" x 3/4"	5.750"	2.625"	T7RWWW-200075PL	92.82	T7RWWW-200075PM	130.63
2" x 1"	5.750"	2.625"	T7RWWW-200100PL	79.55	T7RWWW-200100PM	117.76
2" x 1 1/2"	5.750"	2.625"	T7RWWW-200150PL	80.96	T7RWWW-200150PM	119.17

PL Finish – SF1  
 OD = 32R<sub>a</sub> Mechanically Polished  
 ID = 20R<sub>a</sub> Mechanically Polished

PM Finish – SF4  
 OD = 32R<sub>a</sub> Mechanically Polished  
 ID = 15R<sub>a</sub> Mechanically Polished and Electropolished



## High Purity BioPharm Fittings

63-03  
621

## Weld x Weld x Clamp Short Outlet Tees - T7WWMS

Size	Dimensions		PL finish - SF1		PM finish - SF4	
	A	B	Part #	Price/E	Part #	Price/E
½"	3.750"	1.000"	T7WWMS-050PL	\$66.10	T7WWMS-050PM	\$85.58
¾"	4.000"	1.125"	T7WWMS-075PL	63.65	T7WWMS-075PM	83.20
1"	4.250"	1.125"	T7WWMS-100PL	61.80	T7WWMS-100PM	83.84
1½"	4.750"	1.375"	T7WWMS-150PL	69.36	T7WWMS-150PM	93.59
2"	5.750"	1.625"	T7WWMS-200PL	82.82	T7WWMS-200PM	108.91
2½"	6.250"	1.825"	T7WWMS-250PL	114.43	T7WWMS-250PM	151.67
3"	6.750"	2.125"	T7WWMS-300PL	197.42	T7WWMS-300PM	183.26
4"	8.250"	2.750"	T7WWMS-400PL	209.49	T7WWMS-400PM	255.76



BPE Table DT-4.1.2-2

## Weld x Weld x Clamp Tees - T7WWM

Size	Dimensions		PL finish - SF1		PM finish - SF4	
	A	B	Part #	Price/E	Part #	Price/E
½"	3.750"	2.250"	T7WWM-050PL	\$87.84	T7WWM-050PM	\$110.32
¾"	4.000"	2.375"	T7WWM-075PL	74.71	T7WWM-075PM	98.27
1"	4.250"	2.625"	T7WWM-100PL	73.22	T7WWM-100PM	110.73
1½"	4.750"	2.875"	T7WWM-150PL	83.12	T7WWM-150PM	128.23
2"	5.750"	3.375"	T7WWM-200PL	98.27	T7WWM-200PM	128.23
2½"	6.250"	3.625"	T7WWM-250PL	134.03	T7WWM-250PM	214.57
3"	6.750"	3.875"	T7WWM-300PL	167.06	T7WWM-300PM	301.54
4"	8.250"	4.750"	T7WWM-400PL	246.47	T7WWM-400PM	504.61



## Clamp x Clamp x Clamp Tees - T7MP

Size	Dimensions		PL finish - SF1		PM finish - SF4	
	A	B	Part #	Price/E	Part #	Price/E
½"	4.500"	2.250"	T7MP-050PL	\$101.16	T7MP-050PM	\$124.49
¾"	4.750"	2.375"	T7MP-075PL	101.99	T7MP-075PM	125.26
1"	5.250"	2.625"	T7MP-100PL	111.35	T7MP-100PM	136.60
1½"	5.750"	2.875"	T7MP-150PL	118.90	T7MP-150PM	146.41
2"	6.750"	3.375"	T7MP-200PL	142.96	T7MP-200PM	172.25
2½"	7.250"	3.625"	T7MP-250PL	188.28	T7MP-250PM	227.94
3"	7.750"	3.875"	T7MP-300PL	241.28	T7MP-300PM	284.17
4"	9.500"	4.750"	T7MP-400PL	334.49	T7MP-400PM	381.79



BPE Table DT-4.1.2-4

PL Finish – SF1  
 OD = 32R<sub>a</sub> Mechanically Polished  
 ID = 20R<sub>a</sub> Mechanically Polished

PM Finish – SF4  
 OD = 32R<sub>a</sub> Mechanically Polished  
 ID = 15R<sub>a</sub> Mechanically Polished and Electropolished

High Purity BioPharm Fittings

Weld x Weld Concentric Reducers - T31W



BPE Table DT-4.1.3-1(a)

Size	Dimension A	PL finish - SF1		PM finish - SF4	
		Part #	Price/E	Part #	Price/E
3/4" x 1/2"	4.00"	T31W-075050PL	\$67.77	T31W-075050PM	\$89.56
1" x 1/2"	4.50"	T31W-100050PL	92.62	T31W-100050PM	116.99
1" x 3/4"	4.00"	T31W-100075PL	54.68	T31W-100075PM	80.19
1 1/2" x 1/2"	5.50"	T31W-150050PL	97.11	T31W-150050PM	126.03
1 1/2" x 3/4"	5.00"	T31W-150075PL	71.16	T31W-150075PM	100.90
1 1/2" x 1"	5.00"	T31W-150100PL	58.33	T31W-150100PM	88.40
2" x 1/2"	7.75"	T31W-200050PL	131.73	T31W-200050PM	168.47
2" x 3/4"	7.25"	T31W-200075PL	117.49	T31W-200075PM	154.62
2" x 1"	7.25"	T31W-200100PL	95.26	T31W-200100PM	133.01
2" x 1 1/2"	5.25"	T31W-200150PL	70.39	T31W-200150PM	108.84

Clamp x Clamp Concentric Reducers - T3114MP

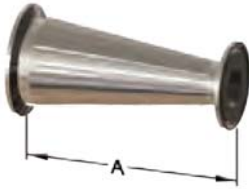

BPE Table DT-4.1.3-3(a)

Size	Dimension A	PL finish - SF1		PM finish - SF4	
		Part #	Price/E	Part #	Price/E
3/4" x 1/2"	2.000"	T3114MP075050PL	\$63.02	T3114MP075050PM	\$93.98
1" x 1/2"	2.500"	T3114MP100050PL	89.36	T3114MP100050PM	123.02
1" x 3/4"	2.000"	T3114MP100075PL	71.60	T3114MP100075PM	105.76
1 1/2" x 1/2"	3.500"	T3114MP150050PL	125.44	T3114MP150050PM	157.52
1 1/2" x 3/4"	3.000"	T3114MP150075PL	97.69	T3114MP150075PM	135.58
1 1/2" x 1"	3.000"	T3114MP150100PL	70.96	T3114MP150100PM	109.68
2" x 1/2"	5.500"	T3114MP200050PL	138.91	T3114MP200050PM	180.07
2" x 3/4"	5.000"	T3114MP200075PL	133.40	T3114MP200075PM	174.74
2" x 1"	5.000"	T3114MP200100PL	116.02	T3114MP200100PM	160.13
2" x 1 1/2"	3.000"	T3114MP200150PL	83.84	T3114MP200150PM	128.85

PL Finish – SF1

OD = 32R<sub>a</sub> Mechanically Polished

ID = 20R<sub>a</sub> Mechanically Polished

PM Finish – SF4

OD = 32R<sub>a</sub> Mechanically Polished

ID = 15R<sub>a</sub> Mechanically Polished and Electropolished

## High Purity BioPharm Fittings

## Weld x Weld Eccentric Reducers - T32W

621

63-03

Size	Dimension A	PL finish - SF1		PM finish - SF4	
		Part #	Price/E	Part #	Price/E
3/4" x 1/2"	4.00"	<b>T32W-075050PL</b>	<b>\$92.62</b>	<b>T32W-075050PM</b>	<b>\$116.99</b>
1" x 1/2"	4.50"	<b>T32W-100050PL</b>	<b>100.96</b>	<b>T32W-100050PM</b>	<b>129.82</b>
1" x 3/4"	4.00"	<b>T32W-100075PL</b>	<b>59.16</b>	<b>T32W-100075PM</b>	<b>89.23</b>
1 1/2" x 1/2"	5.50"	<b>T32W-150050PL</b>	<b>124.23</b>	<b>T32W-150050PM</b>	<b>156.87</b>
1 1/2" x 3/4"	5.00"	<b>T32W-150075PL</b>	<b>79.37</b>	<b>T32W-150075PM</b>	<b>113.27</b>
1 1/2" x 1"	5.00"	<b>T32W-150100PL</b>	<b>59.10</b>	<b>T32W-150100PM</b>	<b>90.90</b>
2" x 1/2"	7.75"	<b>T32W-200050PL</b>	<b>158.28</b>	<b>T32W-200050PM</b>	<b>196.60</b>
2" x 3/4"	7.25"	<b>T32W-200075PL</b>	<b>149.94</b>	<b>T32W-200075PM</b>	<b>188.52</b>
2" x 1"	7.25"	<b>T32W-200100PL</b>	<b>114.23</b>	<b>T32W-200100PM</b>	<b>153.85</b>
2" x 1 1/2"	5.25"	<b>T32W-200150PL</b>	<b>72.17</b>	<b>T32W-200150PM</b>	<b>113.07</b>



BPE Table DT-4.1.3-1(a)

## Clamp x Clamp Eccentric Reducers - T3214MP

Size	Dimension A	PL finish - SF1		PM finish - SF4	
		Part #	Price/E	Part #	Price/E
3/4" x 1/2"	2.000"	<b>T3214MP075050PL</b>	<b>\$67.68</b>	<b>T3214MP075050PM</b>	<b>\$101.99</b>
1" x 1/2"	2.500"	<b>T3214MP100050PL</b>	<b>99.93</b>	<b>T3214MP100050PM</b>	<b>137.76</b>
1" x 3/4"	2.000"	<b>T3214MP100075PL</b>	<b>69.16</b>	<b>T3214MP100075PM</b>	<b>107.89</b>
1 1/2" x 1/2"	3.500"	<b>T3214MP150050PL</b>	<b>115.25</b>	<b>T3214MP150050PM</b>	<b>157.11</b>
1 1/2" x 3/4"	3.000"	<b>T3214MP150075PL</b>	<b>94.23</b>	<b>T3214MP150075PM</b>	<b>136.73</b>
1 1/2" x 1"	3.000"	<b>T3214MP150100PL</b>	<b>71.99</b>	<b>T3214MP150100PM</b>	<b>115.13</b>
2" x 1/2"	5.500"	<b>T3214MP200050PL</b>	<b>158.28</b>	<b>T3214MP200050PM</b>	<b>205.84</b>
2" x 3/4"	5.000"	<b>T3214MP200075PL</b>	<b>149.67</b>	<b>T3214MP200075PM</b>	<b>197.57</b>
2" x 1"	5.000"	<b>T3214MP200100PL</b>	<b>119.74</b>	<b>T3214MP200100PM</b>	<b>168.47</b>
2" x 1 1/2"	3.000"	<b>T3214MP200150PL</b>	<b>84.23</b>	<b>T3214MP200150PM</b>	<b>133.98</b>



BPE Table DT-4.1.3-3(a)

PL Finish – SF1  
 OD = 32R<sub>a</sub> Mechanically Polished  
 ID = 20R<sub>a</sub> Mechanically Polished

PM Finish – SF4  
 OD = 32R<sub>a</sub> Mechanically Polished  
 ID = 15R<sub>a</sub> Mechanically Polished and Electropolished

High Purity BioPharm Fittings

Solid End Caps - T16AMP



BPE Table DT-4.1.5-2

Size	Dimensions		PL finish - SF1		PM finish - SF4	
	A	B	Part #	Price/E	Part #	Price/E
1/2" - 3/4"	0.19"	1.00"	<b>T16AMP-050075PL</b>	<b>\$12.22</b>	<b>T16AMP-050075PM</b>	<b>\$20.68</b>
1" - 1 1/2"	0.25"	1.99"	<b>T16AMP-100150PL</b>	<b>14.07</b>	<b>T16AMP-100150PM</b>	<b>22.32</b>
2"	0.25"	2.52"	<b>T16AMP-200PL</b>	<b>17.70</b>	<b>T16AMP-200PM</b>	<b>32.61</b>
2 1/2"	0.25"	3.05"	<b>T16AMP-250PL</b>	<b>24.25</b>	<b>T16AMP-250PM</b>	<b>42.91</b>
3"	0.25"	3.58"	<b>T16AMP-300PL</b>	<b>36.75</b>	<b>T16AMP-300PM</b>	<b>58.25</b>
4"	0.31"	4.69"	<b>T16AMP-400PL</b>	<b>94.77</b>	<b>T16AMP-400PM</b>	<b>112.78</b>

Auto Weld Ferrules - TL14AM7



BPE Table DT-4.1.4-1

Size	Dimension A	PL finish - SF1		PM finish - SF4	
		Part #	Price/E	Part #	Price/E
1/2"	1.75"	<b>TL14AM7-050PL</b>	<b>\$17.50</b>	<b>TL14AM7-050PM</b>	<b>\$31.97</b>
3/4"	1.75"	<b>TL14AM7-075PL</b>	<b>18.47</b>	<b>TL14AM7-075PM</b>	<b>32.91</b>
1"	1.75"	<b>TL14AM7-100PL</b>	<b>24.50</b>	<b>TL14AM7-100PM</b>	<b>41.39</b>
1 1/2"	1.75"	<b>TL14AM7-150PL</b>	<b>24.87</b>	<b>TL14AM7-150PM</b>	<b>43.01</b>
2"	2.25"	<b>TL14AM7-200PL</b>	<b>31.47</b>	<b>TL14AM7-200PM</b>	<b>52.10</b>
2 1/2"	2.25"	<b>TL14AM7-250PL</b>	<b>38.27</b>	<b>TL14AM7-250PM</b>	<b>67.85</b>
3"	2.25"	<b>TL14AM7-300PL</b>	<b>47.17</b>	<b>TL14AM7-300PM</b>	<b>81.44</b>
4"	2.25"	<b>TL14AM7-400PL</b>	<b>80.45</b>	<b>TL14AM7-400PM</b>	<b>121.83</b>

Weld Caps - T16W



BPE Table DT-4.1.5-1

Size	Dimension A	PL finish - SF1		PM finish - SF4	
		Part #	Price/E	Part #	Price/E
1/2"	1.50"	<b>T16W-050PL</b>	<b>\$20.78</b>	<b>T16W-050PM</b>	<b>\$58.79</b>
3/4"	1.50"	<b>T16W-075PL</b>	<b>19.81</b>	<b>T16W-075PM</b>	<b>33.52</b>
1"	1.50"	<b>T16W-100PL</b>	<b>21.55</b>	<b>T16W-100PM</b>	<b>37.64</b>
1 1/2"	1.50"	<b>T16W-150PL</b>	<b>27.18</b>	<b>T16W-150PM</b>	<b>45.39</b>
2"	1.50"	<b>T16W-200PL</b>	<b>31.28</b>	<b>T16W-200PM</b>	<b>51.79</b>

PL Finish – SF1

OD = 32R<sub>a</sub> Mechanically Polished

ID = 20R<sub>a</sub> Mechanically Polished

PM Finish – SF4

OD = 32R<sub>a</sub> Mechanically Polished

ID = 15R<sub>a</sub> Mechanically Polished and Electropolished



## Pressure - Temperature Ratings

- Ratings apply to all products covered by ANSI B16.5 valves conforming to the requirements of this standard must, in other respects, merit these ratings.
- All ratings are maximum allowable non-shock pressures (PSIG) at the tabulated temperatures (degree Fahrenheit). Temperatures are those on the inside of the pressure retaining structure.
- The use of these ratings requires gaskets conforming to the requirements of ANSI B16.5. The user is responsible for selecting gaskets of dimensions and materials to withstand the required bolt loading without injurious crushing, and suitable for the service conditions in all other respects.

Pressure Class	150	300
Test Pressure	425	1100
Service Temperature	Working Pressure	
<b>-20°F to 100°F (-29°C to 38°C)</b>	<b>275</b>	<b>720</b>
<b>150°F (65°C)</b>	<b>255</b>	<b>710</b>
<b>200 (93°C)</b>	<b>240</b>	<b>700</b>
<b>250 (121°C)</b>	<b>225</b>	<b>690</b>
<b>300 (149°C)</b>	<b>210</b>	<b>680</b>
<b>350 (177°C)</b>	<b>195</b>	<b>675</b>
<b>400 (204°C)</b>	<b>180</b>	<b>665</b>
<b>450 (232°C)</b>	<b>165</b>	<b>650</b>
<b>500 (260°C)</b>	<b>150</b>	<b>625</b>
<b>550 (288°C)</b>	<b>140</b>	<b>590</b>
<b>600 (315°C)</b>	<b>130</b>	<b>555</b>
<b>650 (343°C)</b>	<b>120</b>	<b>515</b>
<b>700 (371°C)</b>	<b>110</b>	<b>470</b>
<b>750 (399°C)</b>	<b>100</b>	<b>425</b>

