

**Continental**   
The Future in Motion



## Hydraulics Catalog

2016 Hydraulic Hose, Fittings  
& Equipment

[www.contitech.us](http://www.contitech.us)

**ContiTech**

# What's New?



## Hot Oiler

The Prospector™ Hot Oiler hose was specifically designed to initiate the flow of hot oil (275°F/135°C continuous; 300°F/149°C intermittent) and bring it to the surface. The hose is reinforced with dual-braided, high-tensile steel wire and features an oil- and abrasion-resistant synthetic rubber cover to help get the job done.



## Prospector™ BOP 5000

This fire-tested, very high pressure BOP hose acts as a hydraulic control connection that can be critically important to the well control system. The hose is reinforced with up to six layers of spiraled, high-tensile steel wire to handle pressures that can reach 5,000 psi (34.5 MPa).



## XCP3

With a special flame- and abrasion-resistant construction, the XCP3 & XCP4 take on high-pressure hydraulic applications and are designed to replace SAE100R1 and SAE100R19 when a tougher, more flexible hose is required. With 5X the abrasion resistance over our standard cover, it's easy to see why these hoses are the go-to choice.



## Extended Life XR16SC

When the job requires tight bends, flexibility and abrasion resistance, this high pressure service hose steps up to the task. Using a nitrile inner tube and dual-braided, high-tensile steel wire reinforcement, it can handle 5,800 psi (31 MPa) flows of petroleum- and water-based hydraulic fluids.



## DR2SN

The DR2SN high-pressure hose comes into play during construction, machine, tool and agricultural applications where high temperature petroleum- or water-based hydraulic fluids are a factor. The hose features a blue CPE cover, is flame resistant and meets higher EN/DIN pressures.

# Table of Contents

## 2016 Hydraulic Hose, Fittings & Equipment

What's New?	A
-------------	---

## Table of Contents

Table of Contents	B-F
-------------------	-----

## Product Line Overview

Putting Words to What We Do	G
Staying Connected With You	H
Who We Are	H
Unleash Hydraulics	I-J
Hydraulic Hose Line	K-N
Hydraulic Fittings, Adapters, Standards & Specs	O-P
Hydraulic Equipment & Accessories	Q

## Hydraulic Hose & Fitting Products

Hydraulic Hose & Fitting Products	1
-----------------------------------	---

## Hoses

Hydraulic Hose Nomenclature	3-5
-----------------------------	-----

### Low Pressure

SR6 - SAE 100R6/EN 854 R6	6
HR6 - SAE 100R6/EN 854 R6 (High Temp)	6
HR4 - SAE 100R4 (High Temp)	7
SR3 - SAE 100R3/EN 854 R3	7
IG - Insta-Grip™ 300 Push-On (Rubber Cover)	8
IGHT - Insta-Grip™ HT 300 Push-On (High Temp)	8
IGTC - Insta-Grip™ TC Push-On (Textile Cover)	9
FXG - FLEXA-Grip™ Push-On (Carbryn® Rubber Cover)	9

### Medium Pressure

SR1SN - SAE 100R1AT/1SN	10
SFS - SAE 100R1AT (Fire Suppression)	10
Desert® DR1SN - SAE 100R1AT/1SN (High Temp)	11
SR2SN - SAE 100R2AT/2SN	11

### High Pressure

Desert® DR2SN - SAE 100R2AT-Type S	12
Arctic® LR2SN - SAE 100R2AT/2SN (Low Temp)	12
SR16SC - SAE 100R16/EN 857 2SC	13
Desert® DR16SC - SAE 100R16SC (Constant Pressure)	13
Extended Life XR16SC - SAE 100R16/EN 857 2SC	14

### High Pressure (Continued)

ARMORCOAT™ ARC16SC - SAE 100R16/EN V857 2SC (Abrasion Cover)	14
SCP3 - SAE 100R17 (Constant Pressure)	15
Extended Life XCP3 - SAE 100R17 (Constant Pressure)	15
ARMORCOAT™ ACP3 - SAE 100R17 (Abrasion Cover)	16

### Very High Pressure

Extended Life XCP4 - SAE 100R19/ISO 11237 (Constant Pressure)	16
SR12 - SAE 100R12/EN 856 R12	17
ARMORCOAT™ ARC12 - SAE 100R12/EN 856 R12 (Abrasion Cover)	17
SR13 - SAE 100R13/EN 856 R13	18
ARMORCOAT™ ARC13 - SAE 100R13/EN 856 R13	18
SR15 - SAE 100R15	19
ARMORCOAT™ ARC15 - SAE 100R15 (Abrasion Cover)	19
S4SP - EN 856 4SP/DIN 20023 4SP	20
S4SH - EN 856 4SH/DIN 20023 4SH	20

### Thermoplastic

SR7 - SAE 100R7/EN 855 R7	21
TR7 - SAE 100R7 (Twin-Line)	21
NR7 - SAE 100R7 (Non-Conductive)	22
BR7 - SAE 100R7 (Twin-Line, Non-Conductive)	22
SR8 - SAE 100R8/EN 855 R8	23
TR8 - SAE 100R8 (Twin-Line)	23
NR8 - SAE 100R8 (Non-Conductive)	24
SR18 - SAE 100R18 (Low Temp)	24

### Special Application

NSFX - SAFLEX® (Non-Conductive)	25
Prospector™ SHR - Slim-Hole Rotary Hose	25
Prospector™ BOP 3000 (Blow Out Preventer)	26
Prospector™ BOP 5000 - Very High Pressure (Blow Out Preventer)	26
Prospector™ Hot Oiler	27
SGUN - Grease Gun Hose	27
SHJ - Jack Hose	28
SR14A - SAE 100R14A (High Temp, Stainless Steel Cover, Teflon® Tube)	28

### Fleet Application

SR5 - SAE 100R5	29
Desert® DR5 - SAE 100R5 (High Temp)	30
SCX5 - SAE 100R5 (Rubber Covered)	31
Desert® DUT - SAE J1402 (Universal Truck Hose)	32

### Air Conditioning

Galaxy® G4826 - SAE J2064	33
Galaxy® G4867 - SAE J2064	33
Galaxy® SLE G4890 - SAE J2064	34

Hoses continued on next page

## Hoses (Continued)

### Military Application

MIL-DTL-13444H - Type I	34
MIL-DTL-13444H - Type III	35
MIL-DTL-13531 - Type II, Class A	35
MIL-DTL-3992 - Type I, Class 1	36
MIL-DTL-8788 - Hydraulic Hose	36

Hose Working Pressure Selection Guide	37-42
Hydraulic Hose Special Attributes	43-44
Hose Temperature Limits	45

### Hose Accessories

Protective Sleeving	46
Protective Wrap	46
Hose Routing Clamps	47

## Fittings

Hydraulic Fitting Nomenclature	49-51
Hydraulic Ferrule Nomenclature	51
Perma-Crimp™ Fitting Selection	52
Explanation of Fitting Part Number, Dimensions and Attributes	53

### Section 1

#### (Fittings for hoses: SFS, SR1SN, DR1SN, SCP3, ACP3, XCP3, XCP4, SR2SN, DR2SN, LR2SN, SR16SC, DR16SC, XR16SC, ARC16SC)

How to Use the Fitting Tables, Fitting Description	54
JIC 37° Flare (SAE J514)	55-59
SAE 45° J512 Flare	59-60
SAE 45° Inverted Flare	60-62
NPTF	62-64
NPSM	65
GTF	65
SAE J514 Flareless Tube Fittings	66
Standpipe	66-67
O-Ring Face Seal (SAE J1453 ORS/ORFS)	67-70
O-Ring Boss Straight Thread (SAE J514)	71-72
Code 61 Flange (SAE J518)	73-76
Code 62 Flange (SAE J518)	76-79
Komatsu® Flange	79-80
BSPP (British Standard Pipe Parallel)	81-82
BSPT (British Standard Pipe Tapered)	83
BSP Flat Seat (British Standard Pipe)	83
DIN 24° Light	84-85
DIN 24° Heavy	86-87
DIN 60°	88
Japanese Komatsu® 30° Flare with Metric Threads	89-90
JIS 30° (Parallel Pipe Threads)	90

### Section 2

#### (Fittings for hoses: SR7, TR7, NR7, BR7, SR8, TR8, NR8, SR18)

How to Use the Fitting Tables, Fitting Description	91
JIC 37° Flare (SAE J514)	92-95
SAE 45° Flare J512 Flare	96
SAE 45° Inverted Flare	97-98
NPTF	98-100
NPSM	100
SAE J514 Flareless Tube Fittings	101
Standpipe	101
O-Ring Face Seal (SAE J1453 ORS/ORFS)	102-103
O-Ring Boss Straight Thread (SAE J514)	104-105
BSPP (British Standard Pipe Parallel)	105-106
DIN 60°	106
JIS 30° (Parallel Pipe Threads)	106

### Section 3

#### (Fittings for hoses: SR12, ARC12)

How to Use the Fitting Tables, Fitting Description	107
JIC 37° Flare (SAE J514)	108-112
NPTF	113-114
NPT	114
NPSM	115
Standpipe	116
O-Ring Face Seal (SAE J1453 ORS/ORFS)	116-120
O-Ring Boss Straight Thread (SAE J514)	121
Code 61 Flange (SAE J518)	122-128
Code 62 Flange (SAE J518)	128-133
Caterpillar® Flange	133-137
Komatsu® Flange	137-138
BSP Flat Seat (British Standard Pipe Parallel)	141
BSPP (British Standard Pipe Parallel)	138-141
BSPT (British Standard Pipe Tapered)	141
DIN 24° Light	142-144
DIN 24° Heavy	144-145
Japanese Komatsu® 30° Flare with Metric Threads	146-147
JIS 30° (Parallel Pipe Threads)	147

### Section 4

#### (Fittings for hoses: SR13, ARC13, SR15, ARC15, S4SP, S4SH)

How to Use the Fitting Tables, Fitting Description	148
JIC 37° Flare (SAE J514)	149-152
NPTF	153-154
NPT	155
NPSM	155
Standpipe	156
O-Ring Face Seal (SAE J1453 ORS/ORFS)	156-160
O-Ring Boss Straight Thread (SAE J514)	160
Code 61 Flange (SAE J518)	161-166
Code 62 Flange (SAE J518)	167-171
Caterpillar® Flange	172-176
Komatsu Flange	176-177
BSPP (British Standard Pipe Parallel)	177-180
BSPT (British Standard Pipe Tapered)	181
BSP Flat Seat (British Standard Pipe)	181
DIN 24° Light	181-182
DIN 24° Heavy	183-185
Japanese Komatsu® 30° Flare with Metric Threads	185-186
JIS 30° (Parallel Pipe Threads)	186

**Section 5****(Fittings for hoses: SR3, HR4, SR6, HR6)**

How to Use the Fitting Tables, Fitting Description	187
JIC 37° Flare (SAE J514)	188-191
SAE 45° Flare (J512)	191-192
SAE 45° Inverted Flare	193-194
NPTF	194-196
NPSM	196
Flareless Tube Fitting (SAE J514)	197
Standpipe	197
O-Ring Face Seal (SAE J1453 ORS/ORFS)	198-201
O-Ring Boss Straight Thread (SAE J514)	201-202
Code 61 Flange (SAE J518)	203-205
Code 62 Flange (SAE J518)	206-207
BSPP (British Standard Pipe Parallel)	207-209
BSPT (British Standard Pipe Tapered)	209
BSP Flat Seat (British Standard Pipe)	210
DIN 24° Light	210-212
DIN 24° Heavy	212-214
DIN 60°	214-215
Japanese Komatsu® 30° Flare with Metric Threads	215-216
JIS 30° (Parallel Pipe Threads)	216

**Section 6****(Fittings for hoses: SR5, DR5, SCX5)**

How to Use the Fitting Tables, Fitting Description	217
JIC 37° Flare (SAE J514)	218-223
SAE 45° Flare (J512)	223-226
SAE 45° Inverted Flare	226-227
NPTF	228-230
NPSM	231
SAE J514 Flareless Tube Fittings	231
Standpipe	231-232
O-Ring Face Seal (SAE J1453 ORS/ORFS)	232-234
O-Ring Boss Straight Thread (SAE J514)	235-236
Code 61 Flange (SAE J518)	236-237
Code 62 Flange (SAE J518)	237
BSPP (British Standard Pipe Parallel)	238-239
BSPT (British Standard Pipe Tapered)	239
BSP Flat Seat (British Standard Pipe)	240
DIN 24° Light	240-242
DIN 24° Heavy	242-243
DIN 60°	244
Japanese Komatsu® 30° Flare with Metric Threads	244-245
JIS 30° (Parallel Pipe Threads)	245

**Section 6A****(Fittings for hoses: DUT)**

How to Use the Fitting Tables, Fitting Description	246
JIC 37° Flare (SAE J514)	247-248
SAE 45° J512 Flare	248-249
SAE 45° Inverted Flare	249-250
NPTF	250
SAE J514 Flareless Tube Fittings	251
Flange Engine Oil Connection (Two Bolt)	251
PTT 30°	251

**Section 7****(Fittings for hoses: NSFX, SHR, HOT OILER, SGUN, SHJ, IG, IGHT, IGTC, FXG)**

How to Use the Fitting Tables, Fitting Description	252
--	-----

**“SF” NSFX Hose Fittings****(For use with SAFLEX® Hose)**

JIC 37° Flare (SAE J514)	253
NPTF	253
O-Ring Boss	254

**SHR Hose Fittings****(For use with Prospector™ Slim Hole Rotary Hose)**

NPT	254-255
IHUF Fig 1502	255
IHUM Fig 1502	255

**Hot Oiler Hose Fittings****(For use with Prospector™ Hot Oiler Hose)**

NPT	255
IHUF Fig 1502	255
IHUM Fig 1502	255

**“GG” SGUN Hose Fittings****(For use with Grease Gun Hose)**

NPTF	256
------	-----

**“B2” SHJ Hose Fittings****(For use with Jack Hose)**

NPTF	256
------	-----

**“PB” Push-On Brass Fittings****(For use with IG, IGHT, IGTC & FXG Hose)**

Hose Mender	257
JIC 37° Flare	257-258
NPTF	258-260
SAE 45° Flare	260
SAE 45° Inverted Flare	261

**Section 8****(Air Conditioning Fittings and Adapters for hoses: Galaxy® G4826, G4867, G4890)**

A/C Fitting Nomenclature	262
How to Use the Fitting Tables, Fitting Description	263

**“AC” (Crimp) Fittings****(For use with Galaxy® G4826 (5/16"-5/8") & G4867 (3/4") Hose)**

Compressor O-Ring Tube	264
Flareless Tube	265
Hose Mender	266
Hose Mender with Sight Glass	267
Hose Mender, Tee	267
O-Ring Insert	267-269
O-Ring Tube	269-274
SAE 45° Flare	274-276

Section 8 continued on next page

## Fittings (Continued)

---

### Section 8

#### "GC" Cool Clip® Fittings

##### (For use with Galaxy® G4890 Hose)

Compressor Pad Block	276
Compressor O-Ring Tube	277
Flareless Tube	277-278
Ford Spring Lock	279-280
Hose Mender	280-282
O-Ring Face Seal	282
O-Ring Insert	282-284
O-Ring Tube	284-288
SAE 45° Flare	288-290

#### A/C Adapters

O-Ring Tube Compressor Female to O-Ring Insert	290
O-Ring Tube Female to O-Ring Insert	290-291

#### "AC" Crimp & "GC" Cool Clip® Fitting Accessories

Flareless Tube Nuts	291
Flareless Tube Sleeves	292
Inline Orifice Tubes	292
O-Ring	292-293
Sealing Washers	293
Valve Adapters	293
Valve Caps	293
Valve Core	294
Metal Clip	294
Plastic Clip Holder	294
Clip Pliers	294
Hose Cutting Tool & Replacement Blades	294

### Section 9

Uni-Crimp™ and Dual-Grip™ Fitting Ferrules	295
--	-----

#### Uni-Crimp™ Ferrule

UCF1	295
UCF2	295
UCF3	295
UCF4	296
UCF5	296
UCF6	296
UCF7	297
UCF8	297
UCF9	297
UCF10	298
UCF11	298

#### Dual-Grip™ Ferrule

DGF1	298
DGF2	298

## Fitting Reference Charts & Accessories

Choosing the Correct Fittings	299
Fitting Working Pressure Charts	300
Thread Reference Chart	301-302
Fitting Accessories (O-Rings)	303-304
Split Flanges, Code 61 and Code 62 (SAE J518)	305
German Metric Thread ID Template	306
Code 61/Code 62/CAT® Flange ID Template	307
Thread Identification Kit	308

## Equipment & Accessories

---

### Crimpers (with Associated Parts)

PC125M	311
PC125RCD	313
PC150 Series	314
PC150H Series	315
PC200 Series	316
PC400 Series	317
PC440 Series	318
PC600L Crimper	319
PC1000 Crimper	320

### Test Benches

PCTB-1500	321
PCTB-2500	321

### Hose Saws

HS150	321
HS301	322
HS303	322
HS501	322
HS503	322

### Fitting Cabinets (with Associated Parts)

CB102	323
CB103	323

## Assemblies

---

Selecting the Proper Hose Assembly, S.T.A.M.P.E.D.	324
S.T.A.M.P.E.D. Form	325
Defining Hose and Assembly Length	326-327

**Steps In Hose Assembly**

Ultra-Crimp™ 1-Piece Crimped Fittings	328-329
Uni-Crimp™ 2-Piece Crimped Fittings	330-331
Field-Grip™ Reusable Fittings	332-333
Internal and External Skiving	334
SR14A Hose Assembly	335-336
Steps in Cool Clip® A/C Hose Assembly	337
A/C Fitting Crimping Procedure for PC125 Crimper	338-339

**Installation & Maintenance**

Service Life Factors	341
Safety Considerations	342
Proper Installation & Hose Routing	343-344
Hose Maintenance & Storage	345

**Appendix****Fitting Identification**

Measuring Threads and Seat Angles	347
Measuring Thread Pitch	347
Comparing Measurements to the Tables	347

**Fitting Standards by Thread Type**

North American	348-349
SAE	349-353
British	354
French	355
German	356-360
Japanese	361-363

**Templates**

Male Pipe Thread Sizes	364
JIC 37° Flare (SAE J514) Thread Sizes	364
37° and 45° Flare Nose Angles	364
SAE 45° Flare (SAE J512) Thread Sizes	364
O-Ring Face Seal (SAE J1453 ORS/ORFS)	365

Fitting Nuts	365
Torque Values	366-367
Hose ID Selection Nomograph	368-369
Hose Pressure Drop	370
Chemical Resistance Tables	371-405
Temperature Conversion Chart	404-407
Pressure Conversions	408
Fraction Equivalents	409
Conversion Constants	410

**Family Part Number - Alphanumeric Index**

Descriptive Numbers	411-416
Product Numbers	417-422

## Putting Words to What We Do

Choose us as your sole supplier for hydraulic assembly components, including hoses, fittings, adapters and the assembly equipment. Because, whatever your application - construction, agriculture, oil and gas, manufacturing, transportation - our broad selection will connect you with a high-quality, reliable hydraulic hose assembly system. And you can trust that our products meet these global performance standards: SAE, DIN, JIS, USCG, ABS and US MSHA.

Not only are our hydraulic hose products designed to make a very literal connection - to each other and to your equipment - our network of distributors is ready to connect with you and your business needs. And we strive to do it all in the most friendly and efficient manner possible.

Being easy to work with can really be a differentiator in the hydraulic hose market. We know this and will always do our best to make sure your business is treated with the attention and care it deserves. That is our commitment to you.



Crimpers

Adapters & Fittings



Hoses





## Staying Connected With You



Experienced hydraulic sales specialists



Friendly customer service representatives



Application engineers for technical assistance



Interactive website with important, up-to-date information



OneSource Distribution Network



Local support on a global basis

## Who We Are

Continental ContiTech is the authority in elastomer compounding and reinforcement technology. Our history in the business gives us the expertise to not only make reliable products, but also to know the industry and its needs. And we are constantly innovating new ways to better serve our customers.

Under the Continental ContiTech brand, we manufacture a wide assortment of consumer and commercial products. In fact, we are one of the few manufacturers in the world that can offer a full breadth of industrial rubber products including

- › Industrial Hose › Conveyor Belts
- › Power Transmission Belts
- › Hydraulic Hose and Fittings › Air Springs
- › Rubber Track



## Unleash Hydraulics

Whether the application is construction, oil and gas, agriculture, mining, manufacturing or transportation, designers and engineers are finding new ways to apply hydraulic power. We have your equipment needs covered with Continental ContiTech hydraulic hoses to meet the demands of the application and the environment. Plus, our hoses meet all major global standards.

### Hydraulic Hose Standards & Specs

Continental ContiTech Hydraulic Hoses

- › Are produced to ISO 9001 certification
- › Undergo state-of-the-art manufacturing processes
- › Meet the applied international standards of SAE J517, EN 853, EN 854, EN 855, EN 856, EN 857, DIN 20023

### Featuring



#### Arctic® Low Temperature Hose

- › -67°F (-55°C) low-temperature service
- › LR2SN (SAE 100R2AT/2SN) high-pressure hydraulic applications



#### Armorcoat™ Hose Cover

- › Super tough cover for high-abrasion applications
- › Can replace protective sleeves
- › Mine Safety and Health Administration (MSHA) rated
- › ARC12 (SAE 100R12/EN 856 R12), ARC13 (SAE100R13/EN 856 R13), ARC15 (SAE 100R15), ARC16SC (SAE 100R16/EN 857 2SC) and ACP3 (SAE 100R17) hydraulic applications



#### Braided Hose

- › Higher EN/DIN pressures
- › Arctic®, Desert® and Armorcoat™ constructions
- › SR1SN (SAE 100R1AT/1SN), Desert® DR1SN (SAE 100R1AT/1SN), SR2SN (SAE 100R2AT/2SN), Arctic® LR2SN (SAE 100R2AT/2SN), Desert® DR2SN (SAE 100R2AT/2SN), SR16SC (SAE 100R16/857 2SC), Armorcoat™ ARC16SC (SAE 100R16/857 2SC), Desert® DR16SC (SAE 100R16/857 2SC), Extended Life XR16SC (SAE 100R16/857 2SC), SCP3 (SAE 100R17), Armorcoat™ ACP3 (SAE 100R17), Extended Life XCP3 (SAE 100R17), Extended Life XCP4 (SAE 100R19)
- › SFS (Fire Suppression SAE 100R1AT)





**High Temperature (H) and Desert® (D) Hoses**

- › 275°F (135°C) and 302°F (150°C) high-temperature service
- › DR1SN (SAE 100R1AT/1SN), DR2SN (SAE 100R2AT/2SN), HR6 (SAE 100R6/EN 854 R6) and HR4 (SAE 100R4) and DR16SC (SAE 100R16/2SC)
- › DR2SN to 302°F (150°C) service, DR5 (SAE 100R5/J1942), DUT (J1402)



**Fleet Applications**

- › SR5 (SAE 100R5)
- › DR5 (high-temperature service)
- › DUT (SAE J1402 Type A1)
- › Air conditioning hose
- › Military vehicles



**High Pressure Hose**

- › 4- and 6-spiral hose
- › Armorcoat™ abrasion cover available
- › Very-high-pressure and high-pulsating applications up to 6000 psi
- › MSHA covers
- › SR12 (SAE 100R12/EN 856 R12), SR13 (SAE 100R13/EN 856 R13), SR15 (SAE 100R15), S4SH (EN 856 4SH/DIN 20023 4SH) and S4SP (EN 856 4SP/DIN 20023 4SP) hydraulic applications



**Low Pressure Hose**

- › 300-1250 psi
- › Textile reinforcement
- › SR3 (SAE 100R3), SR6 (SAE 100R6)
- › HR6 (SAE 100R6), HR4 (SAE 100R4)
- › Push-On Hose, Insta-Grip™ 300, Insta-Grip™ HT 300, Insta-Grip™ TC and FLEXA-Grip™



**Non-Conductive Hose**

- › NSF (SAFLEX®) medium-pressure hydraulic applications
- › Thermoplastic Hose including NR7 (SAE 100R7), NR8 (SAE 100R8) and BR7 (SAE 100R7)
- › Twin-lines available















**Teflon Hose**

- › 500°F (266°C) high-temperature intermittent service
- › Chemical resistance
- › Stainless steel braided cover
- › SR14A (SAE 100R14)

# Hydraulic Hose Line

Varied pressures, abrasion levels and temperatures are no match for Continental ContiTech Hydraulic Hoses.

 <p>3/16" - 2"</p>	 <p>1/4" - 2"</p>	 <p>3/16" - 2"</p>	 <p>1/4" - 2"</p>
<p><b>SR1SN</b> SAE 100R1AT/1SN Hydraulic applications requiring 1-braid hose at higher EN/DIN pressures.</p>	<p><b>Desert® DR1SN</b> SAE 100R1AT/1SN High-temperature 1-braid hose at EN/DIN pressures.</p>	<p><b>SR2SN</b> SAE 100R2AT/2SN Hydraulic applications requiring 2-braid hose at higher EN/DIN pressures.</p>	<p><b>Desert® DR2SN</b> SAE 100R2AT/2SN High-temperature 2-braid hose at EN/DIN pressures.</p>
 <p>1/4" - 2"</p>	 <p>1/4" - 1"</p>	 <p>1/4" - 4"</p>	 <p>3/16" - 1½"</p>
<p><b>Arctic® LR2SN</b> SAE 100R2AT/2SN High-pressure, low-temperature hydraulic oil lines.</p>	<p><b>SR3</b> SAE 100R3/EN 854 R3 Low-pressure, 2 textile braid reinforced hose.</p>	<p><b>HR4 High Temperature</b> SAE 100R4 Low-pressure, high-temperature return line or suction line.</p>	<p><b>SR5</b> General purpose, medium-pressure applications.</p>
 <p>3/16" - 1½"</p>	 <p>1/4" - 1½"</p>	 <p>3/16" - 1½"</p>	 <p>3/16" - 3/4"</p>
<p><b>Desert® DR5</b> SAE 100R5/SAE J1942 Medium-pressure, high-temperature blue textile cover reinforced with 1-braid steel wire.</p>	<p><b>SCX5</b> SAE 100R5-type Rubber covered, USCG approved.</p>	<p><b>Desert® DUT</b> SAE J1402 Type A1 High-temperature, medium-pressure fleet applications.</p>	<p><b>SR6</b> SAE 100R6/854 R6 Low-pressure, textile-reinforced applications.</p>



**HR6 High Temperature**  
**SAE 100R6/854 R6**  
 Low-pressure, high-temperature textile-reinforced applications.



**SR7**  
**SAE 100R7/855 R7**  
 Medium-pressure thermoplastic hose with a perforated cover.



**TR7**  
**SAE 100R7 (Twin-Line)**  
 Medium-pressure, twin-line thermoplastic hose with a perforated cover.



**NR7**  
**SAE 100R7 (Non-Conductive)**  
 Medium-pressure thermoplastic hose with a non-perforated cover.

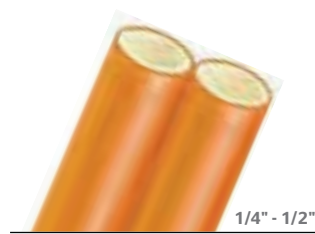

**BR7**  
**SAE 100R7 (Twin-Line, Non-Conductive)**  
 Medium-pressure, twin-line thermoplastic hose with a non-perforated cover.



**SR8**  
**SAE 100R8/855 R8**  
 High-pressure thermoplastic hose with a perforated cover.



**TR8**  
**SAE 100R8 (Twin-Line)**  
 High-pressure, twin-line, thermoplastic hose with a perforated cover.

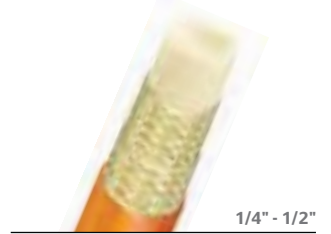

**NR8**  
**SAE 100R8 (Non-Conductive)**  
 High-pressure thermoplastic hose with a non-perforated cover.



**S4SP**  
**EN 856 4SP/DIN 20023 4SP**  
 A 4-spiral hydraulic hose for very-high-pressure applications.



**S4SH**  
**EN 856 4SH/DIN 20023 4SH**  
 A 4-spiral hydraulic hose for very-high-pressure, pulsating applications.



**SR12**  
**SAE 100R12/856 R12**  
 A 4-spiral hydraulic hose for very-high-pressure applications subject to surges or flexing.



**Armorcoat™ ARC12**  
**SAE 100R12/856 R12**  
 For very-high-pressure applications subject to surges or flexing and requiring an abrasion-resistant cover.



**SR13**  
**SAE 100R13/856 R13**  
 A 4- and 6-spiral hose for very-high-pressure applications subject to surges or flexing.



**Armorcoat™ ARC13**  
**SAE 100R13/856 R13**  
 A 4- and 6-spiral hose for very-high-pressure applications subject to surges or flexing and requiring maximum abrasion resistance.



**SR14A**  
**SAE 100R14A**  
 PTFE line hose for air compressor discharge, hot oils and fluids, used under demanding physical conditions.



**SR15**  
**SAE 100R15**  
 A 4- and 6-spiral hose for severe high-pressure applications.



1/2" - 1"

**Armorcoat™ ARC15**

SAE 100R15

A 4-spiral hose for severe high-pressure and abrasive applications.



1/4" - 1 1/4"

**SR16SC**

SAE 100R16/857 2SC

For high-pressure service with tight bends exceeding SAE 100R2 and SAE 100R16 standards.



1/4" - 1"

**Desert® DR16SC**

SAE 100R16

High-pressure 2-braid hose with excellent impulse performance and high flexibility.



1/4" - 1"

**Armorcoat™ ARC16SC**

SAE 100R16/857 2SC

For high-pressure service with tight bends requiring ultimate abrasion resistance.



1/4" - 1"

**XCP4**

SAE 100R19/ISO 11237

High-pressure hydraulic applications requiring extra abrasion resistance. Excellent impulse performance and flexibility meeting SAE 100R19 and ISO-11237 standards.



1/4" - 1"

**XR16SC**

SAE 100R16/857 2SC

For high-pressure service with tight bends requiring maximum abrasion resistance.

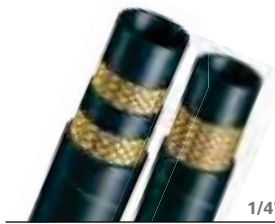

1/4" - 1"

**SCP3**

SAE J1942

For high-pressure hydraulic applications designed to replace where higher pressures and a more flexible hose are required.



1/4" - 1/2"

**Armorcoat™ ACP3**

SAE 100R17

For high-pressure hydraulic applications requiring greater flexibility and ultimate abrasion resistance.



1/4" - 1"

**XCP3**

SAE 100R17

For high-pressure hydraulic applications replacing SAE 100R17 with greater flexibility and superior abrasion resistance.



1/4" - 1/2"

**SR18**

SAE 100R18

Thermoplastic hose, highly flexible even in cold temperatures.



1/4" - 1/2"

**NSFLEX**

SAFLEX®

Medium-pressure, non-conductive applications where shock hazards exist.



1/4" - 1"

**SFS**

Fire Suppression Hose

Medium-pressure fire suppressant applications for mining, forestry and firefighting equipment.



3/16" only

**SGUN**

Grease Gun Hose

Used as a grease whip hose or general purpose lubrication line.

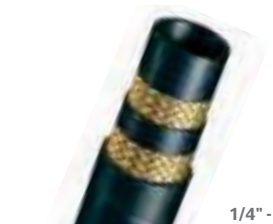

1/4" - 3/8"

**SHJ**

Jack Hose

For extreme high-pressure hydraulic lines for jacking systems.



1/4" - 1"

**Insta-Grip™ 300**

Push-On

For use with push-on fittings, 300 psi and applications requiring non-conductivity.



1/4" - 3/4"

**Insta-Grip™ HT 300**

Push-On

For use with push-on fittings at working pressures up to 300 psi.



**FLEXA-Grip™ 300**

**Push-On**

For use with push-on fittings, 300 psi and applications requiring abrasion-resistant cover.



**Insta-Grip™ TC**

**Push-On**

For low-pressure hydraulic and pneumatic systems.

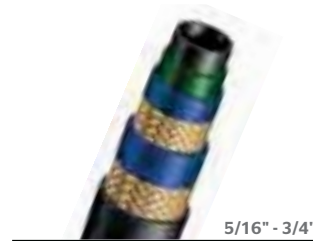

**Galaxy® 4890, 4826, 4867**

**Air Conditioning Hose**

For AC applications requiring Cool Clip® or Cool Crimp™ fittings.

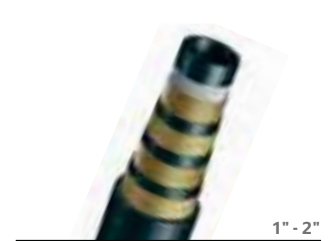

**Prospector™ Slim Hole Rotary**

**SHR**

For high-pressure slim hole, seismograph, work-over or portable drill rigs.



**Prospector™ BOP 3000**

**Blow Out Prevention**

For hydraulic connection between the well control equipment and the control system in oil and gas exploration.



**Prospector™ BOP 5000**

**Blow Out Prevention**

For hydraulic connection between the well control equipment and the control system in oil and gas exploration.



**Prospector™ Hot Oiler**

**Static Pressure**

For initiating the flow of hot oil (275°F/135°C continuous; 300°F/149°C intermittent) and bringing it to the surface.



**MIL-DTL-3992 Type I, Class 1**

**Military**

For low-pressure flexible connections in air brake systems.



**MIL-DTL-8788**

**Military**

High-pressure hydraulic systems requiring interoperability and compatibility with associated components and equipment.



**MIL-DTL-13444H Type I**

**Military**

Fuel and oil lines in military vehicles.



**MIL-DTL-13444H Type III**

**Military**

For medium-pressure hydraulic oil and fuel lines.



**MIL-DTL-13531 Type II, Class A**

**Military**

Medium- and high-pressure hydraulic systems.

# Hydraulic Fittings, Adapters Standards & Specs

Low-, medium- and high-pressure fittings are available for braided, spiral and thermoplastic hose.

## Fittings

- › Ultra-Crimp™ (1-Piece)
- › Uni-Crimp® (2-Piece)
- › Dual-Grip® (2-Piece)
- › Field-Grip®  
(Re-attachable)
- › Push-On
- › Air Conditioning

## Thread-Ends

- › SAE
- › NPTF
- › JIC
- › British Standard
- › DIN
- › JIS
- › API

## End Styles

- › Straights
- › Swivels
- › Elbows
- › Flanges

## Featuring



### Bite-to-Wire

These one-piece crimp fittings provide maximum coupling retention on 1- and 2-braid hoses as well as 4- and 6-spiral hoses. Serrations penetrate the cover with a powerful bite into the wire reinforcement, resulting in even hose compression.



### No Skive

Assemblies made faster, with fewer steps and less mess.

### Full-Length Crimp

Maximum coupling retention for a safe and longer lasting assembly; easier to crimp with a lower profile.



### Zinc Plating

- › Offers corrosion resistance for extended hose assembly and fitting life, easily surpassing the corrosion resistance of SAE J516, ASTM B117.
- › Silver chromium 6 Free plating on Ultra-Crimp™ Uni-Crimp® and Dual-Grip® fittings.





**Full Line of High Pressure Spiral Hose Couplings**

- › Code 61, Code 62, Cat® Flange and Komatsu® Flange fittings for SAE 100R12 and 100R13
- › Solid one-piece flanged fitting; no braze or weld joints



**Field-Grip® Fittings**

Non-skive, re-attachable for easy installation



**Push-on Fittings**

Fittings compatible with push-on hose, including Insta-Grip™ 300, Insta-Grip™ TC, Insta-Grip™ HT 300 and FLEXA-Grip™ 300



**A/C Fittings**

Cool Clip® and Cool Crimp™ fittings



**Adapters**

Change existing end styles



## Hydraulic Equipment & Accessories

To complete the total assembly solution, look no further than the Continental ContiTech Perma-Crimp® line. In addition to crimpers, we also offer crimper dies, cabinets, pumps, cut-off saws, skivers, hose/fitting pushers and hose assembly test benches.



### Perma-Crimp® PC125MRCD

- › Lightweight for portable field use.
- › Three power options. Attach hand, air or electrical pump.
- › Capable of crimping up to 1 ¼" 2-braid and 1¼" 4-spiral hose.



### Perma-Crimp® PC125RCD

- › Suitable for shop service and bench mounting.
- › Includes 1-HP electric pump on a common base.
- › Capable of crimping up to 1¼" 2-braid and 1¼" 4-spiral hose.



### Perma-Crimp® PC125PS

- › Positive stop crimper
- › Crimps 2-wire braid hose, and 4-wire spiral hose up through 1" ID



### Perma-Crimp® PC150

- › Stationary crimper with more power to manufacture hose assemblies.
- › Includes 2-HP electric pump on a common base for bench mounting.
- › Capable of crimping up to 1½" 2-braid and 4-spiral hose.



### Perma-Crimp® PC150H

- › High-volume, stationary crimper.
- › 1-HP power source.
- › Capable of crimping up to 1½" 2-braid and 4-spiral hose.



### Perma-Crimp® PC200-P

- › High-capacity, stationary, "production" crimper.
- › 7.5-HP power source.
- › Microprocessor control for fast and accurate adjustments.
- › Capable of crimping up to 2" 6-spiral hose.



### Perma-Crimp® PC440-P

- › High-capacity, stationary "production" crimper.
- › 7.5-HP power source.
- › Capable of crimping up to 2" 6-spiral hydraulic and 4" industrial hose.



### Perma-Crimp® PC600L-P

- › High-volume, high-capacity "production" crimper.
- › 7.5-HP power source, 350 ton cylinder.
- › Fully automated ACT programmable controller.
- › Capable of crimping up to 2½" braided spiral hydraulic and up to 6" industrial hose.



### Perma-Crimp® PC1000-P

- › High-volume, high-capacity stationary crimper.
- › Fully automatic ACT3™ microprocessor controller.
- › 1,415 crimps per hour with 450 tons of crimping force.



# Hydraulic Hose & Fitting Products

## Proper Assembly of ContiTech Perma-Crimp® Hose and Fittings.

ContiTech Perma-Crimp® hose, fittings and crimping equipment work together to provide an efficient and reliable hose connection. Hose and fittings are part of an engineered system, and are to be assembled in accordance with ContiTech specifications. Using non-ContiTech components may produce an assembly that does not meet rated performance. **ContiTech does not warrant, expressly or by implication, hose assemblies that do not incorporate ContiTech Perma-Crimp® hose and fittings, or are not crimped in accordance with ContiTech process specifications.**

specifications, as necessary to meet the requirements of the buyer or customer's application. In such cases, the buyer has sole responsibility to qualify the hose for these applications as necessary to ensure performance capability.

For guidance in the assembly of ContiTech Perma-Crimp® hose and couplings, please refer to the ContiTech Crimp Specifications Manual. Information in this catalog is believed to be accurate, but is not warranted, and is subject to change without prior notice. For the most current available product and crimp specifications information, please check our website: [www.contitech.us](http://www.contitech.us).

Buyers may elect to attach additional or non-standard parts or equipment, or to use different manufacturing





# Hydraulic Hose Nomenclature



## Hose Attribute

First character of Part Number

H = High Temp (Desert®), 275°F  
 L = Low Temp (Arctic®)  
 A = Abrasion Cover (Armorcoat™)  
 N = Non-Conductive  
 T = Twin-Line  
 B = Both Non-Conductive and Twin-Line  
 S = Standard Specification Hose  
 D = High Temp (Desert®), 302°F  
 X = Extended Life Abrasion Resistance Cover

Note: Push-On Hose (IG, IGHT, IGTC); Military Hose (MIL, M); and SHR Hose do not have a one-digit Hose Attribute character.

## Hose Standard

Next 2-5 characters of Part Number before hyphen

R1SN = SAE 100R1AT/1SN  
 FS = Fire Suppression (SAE 100R1AT/1SN)  
 R2SN = SAE 100R2AT/2SN  
 R3 = SAE 100R3/EN 854 R3  
 R4 = SAE 100R4  
 R5 = SAE 100R5  
 CX5 = SAE100R5 (Rubber Covered)  
 UT = Universal Truck Hose (SAE J1402 A1)  
 R6 = SAE 100R6/854 R6  
 R7 = SAE 100R7/855 R7  
 SFX = SAFLEX®  
 R8 = SAE 100R8/855 R8  
 4SH = EN 856 4SH/DIN 20023 4SH  
 4SP = EN 856 4SP/DIN 20023 4SP  
 R12 = SAE 100R12/856 R12  
 R13 = SAE 100R13/856 R13  
 R14A = SAE 100R14A  
 R15 = SAE 100R15  
 R16SC = SAE 100R16/857 2SC  
 CP3 = SAE 100R17  
 CP4 = SAE 100R19/ISO11237  
 R18 = SAE 100R18  
 SHR = Prospector™ Slim Hole Rotary  
 BOP = Prospector™ BOP 3000, 5000  
 GUN = Grease Gun Hose  
 HJ = Jack Hose  
 4826 = Galaxy® 4826 (Air Conditioning)  
 4867 = Galaxy® 4867 (Air Conditioning)  
 4890 = Galaxy® 4890 SLE (Air Conditioning)  
 IG = Insta-Grip™ 300 (Push-On)  
 IGTC = Insta-Grip™ TC (Push-On)  
 IGHT = Insta-Grip™ HT 300 (Push-On)  
 FXG = FLEXA-Grip™ (Push-On)  
 M or MIL = Military Hose

## Hose Dash Size

(Hose Inside Diameter) Last 2 characters of Part Number after hyphen

All hoses except

**R5, UT and Galaxy®**

02 = 1/8" (3.3 mm)  
 03 = 3/16" (4.8 mm)  
 04 = 1/4" (6.4 mm)  
 05 = 5/16" (7.9 mm)  
 06 = 3/8" (9.5 mm)  
 08 = 1/2" (12.7 mm)  
 10 = 5/8" (15.9 mm)  
 12 = 3/4" (19 mm)  
 16 = 1" (25.4 mm)  
 20 = 1 1/4" (31.8 mm)  
 24 = 1 1/2" (38.1 mm)  
 32 = 2" (50.8 mm)  
 40 = 2 1/2" (63.5 mm)  
 48 = 3" (76.2 mm)  
 56 = 3 1/2" (89 mm)  
 64 = 4" (101.6 mm)

**SAE 100R5, UT and Galaxy® Hose**

04 = 3/16" (4.8 mm)  
 05 = 1/4" (6.4 mm)  
 06 = 5/16" (7.9 mm)  
 08 = 13/32" (10.3 mm)  
 10 = 1/2" (12.7 mm)  
 12 = 5/8" (15.9 mm)  
 14 = 3/4" (19.1 mm)  
 16 = 7/8" (22.2 mm)  
 20 = 1 1/8" (28.6 mm)  
 24 = 1 3/8" (35 mm)  
 32 = 1 3/4" (46 mm)

Note: Military Hose utilize unique military dash sizes.

## Warning - Selection of Hose

Selection of the proper hose for the application is essential to the proper operation and safe use of the hose and related equipment. Inadequate attention to selection of the hose for your application can result in hose leakage, bursting, or other failure, which can cause serious bodily injury or property damage from spraying fluids or flying projectiles. Some of the factors involved in the selection of the proper hose include:

- › Hose Size
- › Hose Length
- › Hose Ends
- › Fluid Conveyed
- › Bends
- › Temperature
- › Hose Pressure
- › Static Head Pressure
- › Installation Design

The above factors and information provided in this catalog should be considered in selecting the proper hose for your application.

## Hydraulic Hose Nomenclature

### Hydraulic Hose Part Number Designations

Part Number	Description	Page Number
SR6	SAE 100R6/EN 854 R6	6
HR6	SAE 100R6/EN 854 R6 (High Temp)	6
HR4	SAE 100R4 (High Temp)	7
SR3	SAE 100R3/EN 854 R3	7
IG	Insta-Grip™ 300 Push-On (Rubber Cover)	8
IGHT	Insta-Grip™ HT 300 Push-On (High Temp)	8
IGTC	Insta-Grip™ TC Push-On (Textile Cover)	9
FXG	FLEXA-Grip™ Push-On (Carbryn® Rubber Cover)	9
SR1SN	SAE 100R1AT/1SN	10
SFS	SAE 100R1AT/1SN (Fire Suppression)	10
Desert® DR1SN	SAE 100R1AT/1SN (High Temp)	11
SR2SN	SAE 100R2AT/2SN	11
Desert® DR2SN	SAE 100R2AT/2SN (High Temp)	12
Arctic® LR2SN	SAE 100R2AT/2SN (Low Temp)	12
SR16SC	SAE 100R16/EN 857 2SC	13
Desert® DR16SC	SAE 100R16SC	13
Extended Life XR16SC	SAE 100R16SC/EN 857 2SC	14
ARMORCOAT™ ARC16SC	SAE 100R16/EN 857 2SC (Abrasion Cover)	14
SCP3	SAE 100R17 (Constant Pressure)	15
Extended Life XCP3	SAE 100R17 (Constant Pressure 3000 psi)	15
ARMORCOAT™ ACP3	SAE 100R17 (Abrasion Cover)	16
CP4	SAE 100R19	16
Extended Life XCP4	SAE 100R12/EN 856 R12	17
ARMORCOAT™ ARC12	SAE 100R12/EN 856 R12 (Abrasion Cover)	17
SR13	SAE 100R13/EN 856 R13	18
ARMORCOAT™ ARC13	SAE 100R13/EN 856 R13 (Abrasion Cover)	18
SR15	SAE 100R15	19
ARMORCOAT™ ARC15	SAE 100R15 (Abrasion Cover)	19
S4SP	EN 856 4SP/DIN 20023 4SP	20
S4SH	EN 856 4SH/DIN 20023 4SH	20
SR7	SAE 100R7/EN 855 R7	21
TR7	SAE 100R7 (Twin-Line)	21
NR7	SAE 100R7 (Non-Conductive)	22
BR7	SAE 100R7 (Twin-Line, Non-Conductive)	22
SR8	SAE 100R8/EN 855 R8	23

Hydraulic Hose Part Number Designations (Continued on next page)

# Hydraulic Hose Nomenclature

Continued

## Hydraulic Hose Part Number Designations

Part Number	Description	Page Number
TR8	SAE 100R8 (Twin-Line)	23
NR8	SAE 100R8 (Non-Conductive)	24
SR18	SAE 100R18	24
NSFX	SAFLEX® (Non-Conductive)	25
Prospector™ SHR	Slim Hole Rotary Hose	25
Prospector™ BOP 3000	Special Application (Blow Out Preventer)	26
Prospector™ BOP 5000	Very High Pressure (Blow Out Preventer)	26
Prospector™ Hot Oiler	Special Application	27
SGUN	Grease Gun Hose (Special Application)	27
SHJ	Jack Hose (Special Application)	28
SR14A	SAE 100R14A (Stainless Steel Cover, Teflon® Tube)	28
SR5	SAE 100R5 (Fleet Application)	29
Desert® DR5	SAE 100R5 (High Temp, Fleet Application)	30
SCX5	SAE 100R5 (Rubber Covered, Fleet Application)	31
Desert® DUT	SAE J1402 A1 (Universal Truck Hose, Fleet Application)	32
Galaxy® G4826	SAE J2064 (Air Conditioning)	33
Galaxy® G4867	SAE J2064 (Air Conditioning)	33
Galaxy® G4890	SAE J2064 (Air Conditioning)	34
MIL-DTL-13444H	Type I (Military Application)	34
MIL-DTL-13444H	Type III (Military Application)	35
MIL-DTL-13531	Type II, Class A (Military Application)	35
MIL-DTL-3992	Type I, Class 1 (Military Application)	36
MIL-DTL-8788	Hydraulic Hose (Military Application)	36

Fittings

Equipment &amp; Accessories

Assemblies

Installation &amp; Maintenance

Appendix



## SR6

## SAE 100R6/EN 854 R6 | Low Pressure



› Meets or exceeds the performance requirements of: SAE 100R6/EN 854 R6.

**Application**

Low-pressure, textile reinforced applications including petroleum and water-based fluids for use as power steering return, lube lines and air lines. Not for brake applications.

**Inner Tube**

Nitrile

**Reinforcement**

One textile braid

**Cover**

Black polychloroprene

**Temperature Range**

-40°F to 212°F (-40°C to 100°C)

**Fitting Reference**

All fittings compatible with the SR6 hose family are listed in Section 5 (starting on page 187) of the catalog.

**Branding**

Example: Continental ContiTech SR6-03 SAE 100R6 R6 3/16" (DN05) W.P. 500 psi (3.4 MPa)

Descriptive #/ Product #	SAP #	Hose Size ID		Hose OD		Max. Working Pressure		Min. Bend Radius		Min. Burst Pressure		Weight lbs./ft.
		in.	DIN Dash Size	in.	mm	psi	MPa	in.	mm	psi	MPa	
SR6-03	20240277	3/16	05	0.44	11.1	500	3.4	2.0	51	2000	13.8	0.07
SR6-04	20240278	1/4	06	0.50	12.7	400	2.8	2.5	64	1600	11.0	0.09
SR6-05	20240279	5/16	08	0.56	9.1	400	2.8	3.0	76	1600	11.0	0.09
SR6-06	20240280	3/8	10	0.63	15.9	400	2.8	3.0	76	1600	11.0	0.11
SR6-08	20240281	1/2	12	0.78	19.8	400	2.8	4.0	102	1600	11.0	0.16
SR6-10	20240282	5/8	16	0.91	23.0	350	2.4	5.0	127	1400	9.7	0.18
SR6-12	20254775	3/4	19	1.05	26.6	300	2.1	6.0	152	1200	8.3	0.25

## HR6

## SAE 100R6/EN 854 R6 | Low Pressure



› Meets or exceeds the performance requirements of: SAE 100R6/EN 854 R6.

› High Temperature

**Application**

Low-pressure, textile reinforced applications including petroleum and water-based fluids for use in power steering return, lube lines and air lines. Not for brake applications.

**Inner Tube**

Nitrile

**Reinforcement**

One textile braid

**Cover**

Black CSM (Chlorosulphonated Polyethylene)\*

**Temperature Range**

-40°F to 275°F (-40°C to 135°C)

**Fitting Reference**

All fittings compatible with the HR6 hose family are listed in Section 5 (starting on page 187) of the catalog.

**Branding**

Example: Continental ContiTech HR6-04 SAE 100R6/EN 854 R6 (High Temp) 1/4" (DN06) W.P. 400 psi (2.8 MPa)

Descriptive #/ Product #	SAP #	Hose Size ID		Hose OD		Max. Working Pressure		Min. Bend Radius		Min. Burst Pressure		Weight lbs./ft.
		in.	DIN Dash Size	in.	mm	psi	MPa	in.	mm	psi	MPa	
HR6-04	20687451	1/4	06	0.51	12.9	400	2.8	2.5	64	1600	11.0	0.09
HR6-05	20239412	5/16	08	0.57	14.5	400	2.8	3.0	76	1600	11.0	0.09
HR6-06	20687409	3/8	10	0.64	16.2	400	2.8	3.0	76	1600	11.0	0.11
HR6-08	20743641	1/2	12	0.77	19.6	400	2.8	4.0	102	1600	11.0	0.16
HR6-10	20616767	5/8	16	0.91	23.2	350	2.4	5.0	127	1400	9.7	0.18
HR6-12	20645813	3/4	19	1.06	26.9	300	2.1	6.0	152	1200	8.3	0.25

## HR4

## SAE 100R4 | Low Pressure



1/2 Bend

- › Meets or exceeds the performance requirements of: SAE 100R4
- › High Temperature
- › Meets Flame Resistance USMSHA Designation
- › SAE J1942/ U.S. Coast Guard 

**Application**

Low-pressure, high temperature return line or suction line for petroleum- and water-based hydraulic fluids. Vacuum rating 25 in Hg. HR4 has half the bend radius of typical SAE 100R4.

**Inner Tube**

Nitrile

**Reinforcement**

Spiral-plyed synthetic fabric with wire helix

**Cover**

Black polychloroprene

**Temperature Range**

-40°F to 275°F (-40°C to 135°C)

**Fitting Reference**

All fittings compatible with the HR4 hose family are listed in Section 5 (starting on page 187) of the catalog. Note: No Continental ContiTech fitting recommendation on HR4-48 and HR4-64 hose sizes.

**Branding**

Example: Continental ContiTech HR4-16 SAE 100R4 1" (25mm) WP 325 psi (2.24 MPa) MSHA IC- 233/0  
Made in Canada

Descriptive #/ Product #	SAP #	Hose Size ID		Hose OD		Max. Working Pressure		Min. Bend Radius		Min. Burst Pressure		Weight lbs./ft.	USCG Approved
		in.	mm	in.	mm	psi	MPa	in.	mm	psi	MPa		
HR4-12	20325410	3/4	19.0	1.162	29.5	350	2.41	2.5	64	1400	9.65	0.41	H
HR4-16	20325411	1	25.4	1.460	37.1	325	2.2	3.0	76	1300	9.0	0.59	H
HR4-20	20325412	1¼	31.8	1.712	43.5	250	1.72	4.0	102	1000	6.89	0.72	H
HR4-24	20325413	1½	38.1	1.963	49.9	225	1.55	5.0	127	900	6.21	0.85	H
HR4-32	20325414	2	50.8	2.464	62.6	225	1.6	6.0	152	900	6.21	1.12	H
HR4-40	20325415	2½	63.5	2.971	75.5	140	0.97	7.0	188	560	3.86	1.45	H
HR4-48	20325416	3	76.2	3.533	89.8	135	0.93	9.0	229	540	3.72	1.90	
HR4-64	20325418	4	101.6	4.542	115.4	100	0.69	12	305	400	2.76	2.68	

## SR3

## SAE 100R3/EN 854 R3 | Low Pressure



- › Meets or exceeds the performance requirements of: SAE 100R3/EN 854 R3
- › Meets Flame Resistance USMSHA Designation

**Application**

Low-pressure, textile reinforced hose for petroleum- or water-based hydraulic fluids or pneumatic applications. Not to be used for air brake.

**Inner Tube**

CR (Polychloroprene)

**Reinforcement**

Two textile braids

**Cover**

Black polychloroprene

**Temperature Range**

-40°F to 212°F (-40°C to 100°C)

**Fitting Reference**

All fittings compatible with the SR3 hose family are listed in Section 5 (starting on page 187) of the catalog.

**Branding**

Example: Continental ContiTech SR3-04 SAE 100R3 R3 1/4" (DN06) W.P. 1250 psi (8.6 MPa) MSHA 2G-IC-14C/30

Descriptive #/ Product #	SAP #	Hose Size ID		Hose OD		Max. Working Pressure		Min. Bend Radius		Min. Burst Pressure		Weight lbs./ft.
		in.	DIN Dash Size	in.	mm	psi	MPa	in.	mm	psi	MPa	
SR3-04	20240260	1/4	06	0.56	14.3	1250	8.6	3.0	76	5000	34.5	0.12
SR3-05	20239389	5/16	08	0.68	17.5	1200	8.3	4.0	102	4800	33.1	0.16
SR3-06	20240261	3/8	10	0.75	19.0	1125	7.8	4.0	102	4500	31.0	0.17
SR3-08	20240262	1/2	12	0.94	23.8	1000	6.9	5.0	127	4000	27.6	0.25
SR3-10	20553192	5/8	10	1.06	27.1	884	6.1	5.5	140	3538	24.4	0.31
SR3-12	20240275	3/4	19	1.25	31.8	750	5.2	6.0	152	3000	20.7	0.43
SR3-16	20240276	1	25	1.50	38.1	565	3.9	8.0	203	2260	15.6	0.51

# IG

## INSTA-GRIP™ 300 | Low Pressure Push-On



- › Meets Flame Resistance USMSHA Designation
- › Non-Conductive

### Application

For use with push-on fittings at maximum working pressures of 300 psi. For low-pressure hydraulic and pneumatic systems such as shop air systems, general industrial, maintenance and automotive applications. Non-conductive, minimum electrical resistance, greater than (1) megohm per inch of hose length at 1000 Volts DC. Note: Insta-Grip™ 300 black cover hose meets USMSHA 2G-1C-14C/33. All other colors meet USMSHA 2G-1C-14C/32.

### Inner Tube

Chemivic® (NBR/PVC) oil and heat resistant synthetic rubber (ARPM Class A high oil resistance)

### Reinforcement

One textile braid

### Cover

Black, Blue, Red, Green, Grey (others, contact marketing): weather, abrasion and oil resistant Nitrile synthetic rubber. (RMA Class B medium/high oil resistance)

### Temperature Range

-40°F to 190°F (-40°C to 88°C)

### Fitting Reference

All fittings compatible with the Insta-Grip™ 300 hose family are listed in Section 7 (starting on page 252) of the catalog.

### Branding

Example: Continental ContiTech Insta-Grip™ 1/4" W.P. 300 psi Flame Resistant USMSHA 2G-1C-14C/33 Made in U.S.A.

Descriptive # (***) Insert Color	Product # (***) Insert Color	SAP # (BLK) exc.16 (RED)	Hose Size ID		Hose OD		Max. Working Pressure		Min. Bend Radius		Min. Burst Pressure		Weight	
			in.	mm	in.	mm	psi	MPa	in.	mm	psi	MPa	lbs./ft.	kg/m
(See Legend)	(See Legend)													
IG 300 1/4***	IG***-04	20022636	1/4	6.4	0.54	13.7	300	2.1	2.5	64	1200	8.3	0.09	0.13
IG 300 5/16***	IG***-05	20022641	5/16	7.9	0.62	15.7	300	2.1	3.0	76	1200	8.3	0.12	0.18
IG 300 3/8***	IG***-06	20022644	3/8	9.5	0.69	17.5	300	2.1	3.0	76	1200	8.3	0.14	0.21
IG 300 1/2***	IG***-08	20022648	1/2	12.7	0.81	20.6	300	2.1	5.0	127	1200	8.3	0.16	0.24
IG 300 5/8***	IG***-10	20022651	5/8	15.9	0.93	23.6	300	2.1	6.0	152	1200	8.3	0.20	0.30
IG 300 3/4***	IG***-12	20022653	3/4	19.0	1.07	27.2	300	2.1	7.0	178	1200	8.3	0.25	0.37
IG 300 1***	IG***-16	20136613	1	25.4	1.34	34.0	300	2.1	8.0	203	1200	8.3	0.34	0.51

Colors: Black = BLK, Blue = BLU, Red = RED, Green = GRN, Grey = GRY

# IGHT

## INSTA-GRIP™ HT 300 | Low Pressure Push-On



- › High Temperature

### Application

For lubricating and fuel oils, air and water. Not recommended for applications involving impulse movements or air brake applications. For use with push-on fittings at working pressures up to 300 psi.

### Inner Tube

Black CPE Rubber, Meets ARPM Class B Oil Resistance

### Reinforcement

One synthetic textile braid

### Cover

Black CPE rubber, Meets ARPM Class B oil resistance

### Temperature Range

Petroleum-based hydraulic fluids -40°F to 300°F (-40°C to 150°C)  
Water and Air -40°F to 190°F (-40°C to 88°C)

### Fitting Reference

All fittings compatible with the Insta-Grip™ HT 300 hose family are listed in Section 7 (starting on page 252) of the catalog.

### Branding

Example: Continental ContiTech Insta-Grip™ HT 1/4" 300 psi W.P. Made in U.S.A.

Descriptive #/ Product #	SAP #	Hose Size ID		Hose OD		Max. Working Pressure		Min. Bend Radius		Min. Burst Pressure		Weight
		in.	mm	in.	mm	psi	MPa	in.	mm	psi	MPa	
IGHT-04	20544196	1/4	6.4	0.51	12.8	300	2.1	2.5	64	1200	8.3	0.09
IGHT-06	20544197	3/8	9.5	0.67	17.0	300	2.1	3.0	76	1200	8.3	0.14
IGHT-08	20544198	1/2	12.7	0.76	19.3	300	2.1	5.0	127	1200	8.3	0.16
IGHT-10	20544199	5/8	15.9	0.93	23.6	300	2.1	6.0	152	1200	8.3	0.20
IGHT-12	20571923	3/4	19.0	1.04	26.5	300	2.1	7.0	178	1200	8.3	0.25

## IGTC

## INSTA-GRIP™ TC | Low Pressure Push-On

**Application**

For low-pressure hydraulic and pneumatic systems such as shop air systems, general industrial, maintenance and automotive applications.

**Inner Tube**

Chemivic® (NBR/PVC) oil and heat resistant synthetic rubber (ARPM Class A High Oil Resistance)

**Reinforcement**

One textile braid

**Cover**

Black dyed textile braid, mildew and oil resistance

**Temperature Range**

-40°F to 200°F (-40°C to 93°C)

**Fitting Reference**

All fittings compatible with the Insta-Grip™ TC hose family are listed in Section 7 (starting on page 252) of the catalog.

**Branding**

Example: Continental ContiTech Insta-Grip™ TC 1/4" W.P. 300 psi Made in U.S.A.

Descriptive #/ Product #	SAP #	Hose Size ID		Hose OD		Max. Working Pressure		Min. Bend Radius		Min. Burst Pressure		Weight	
		in.	mm	in.	mm	psi	MPa	in.	mm	psi	MPa	lbs./ft.	kg/m
IGTC-04	20022593	1/4	6.4	0.50	12.7	300	2.1	2.5	64	1200	8.3	0.08	0.12
IGTC-05	20022595	5/16	7.9	0.56	14.2	300	2.1	3.0	76	1200	8.3	0.09	0.13
IGTC-06	20022597	3/8	9.5	0.64	16.3	300	2.1	3.0	76	1200	8.3	0.11	0.16
IGTC-08	20022600	1/2	12.7	0.75	19.1	300	2.1	5.0	127	1200	8.3	0.13	0.19
IGTC-10	20022602	5/8	15.9	0.91	23.1	300	2.1	6.0	152	1200	8.3	0.19	0.28
IGTC-12	20022604	3/4	19.0	1.03	26.2	300	2.1	7.0	178	1200	8.3	0.21	0.31

## FXG

## FLEXA-Grip™ | Low Pressure Push-On

**Application**

For use with push-on fittings at maximum working pressures of 400 psi. For low-pressure hydraulic and pneumatic systems such as robotics, shop air systems, general industrial, maintenance and automotive applications. Non-conductive, minimum electrical resistance, greater than (1) megohm per inch of hose length at 1000 Volts DC.

**Inner Tube**

Chemivic®(NBR/PVC) oil and heat resistant synthetic rubber (ARPM Class A High Oil Resistance)

**Reinforcement**

One textile braid

**Cover**

Black, Blue, Red, Green, Grey, White, Brown and Yellow (others, contact marketing): weather-abrasion and oil resistant Carbryn™ rubber. (ARPM Class A high oil resistance)

**Temperature Range**

-40°F to 200°F (-40°C to 93°C)

**Fitting Reference**

All fittings compatible with the FLEXA-Grip™ hose family are listed in Section 7 (starting on page 252) of the catalog.

**Branding**

Example: Continental ContiTech FLEXA-Grip™ Non-Conductive 3/8" (9.5 mm) W.P. 400 psi (28 bar); Flame Resistant USMSHA 2G-IC-14C / 27 Made in U.S.A.

Descriptive # (***)Insert Color	Product # (***)Insert Color	SAP #	Hose Size ID		Hose OD		Max. Working Pressure		Min. Bend Radius		Min. Burst Pressure		Weight	
			in.	mm	in.	mm	psi	MPa	in.	mm	psi	MPa	lbs./ft.	kg/m
(See Legend)	(See Legend)	(BLK)												
FLEXA-Grip 3/16***	FXG***-03	20022699	3/16	4.8	0.36	9.10	400	2.8	2.5	64	1600	11.0	0.04	0.06
FLEXA-Grip 1/4***	FXG***-04	20022700	1/4	6.4	0.51	13.0	400	2.8	2.5	64	1600	11.0	0.08	0.12
FLEXA-Grip 3/8***	FXG***-06	20022703	3/8	9.5	0.67	17.0	400	2.8	3.0	76	1600	11.0	0.13	0.19
FLEXA-Grip 1/2***	FXG***-08	20022706	1/2	12.7	0.76	19.3	400	2.8	5.0	127	1600	11.0	0.14	0.21
FLEXA-Grip 5/8***	FXG***-10	20022711	5/8	15.9	0.93	23.6	400	2.8	6.0	152	1600	11.0	0.19	0.28
FLEXA-Grip 3/4***	FXG***-12	20022714	3/4	19.0	1.06	26.9	400	2.8	7.0	178	1600	11.0	0.24	0.36
FLEXA-Grip 1***	FXG***-16	20141684	1	25.4	1.34	34.0	400	2.8	8.0	203	1600	11.0	0.34	0.51

Colors: Black = BLK, Blue = BLU, Red = RED, Green = GRN, Grey = GRY, White = WHT, Brown = BRN, Yellow = YEL

# SR1SN

## SAE 100R1AT/1SN | Medium Pressure



- › Meets or exceeds the performance requirements of: SAE 100R1AT; EN 853 1SN
- › Meets Flame Resistance USMSHA Designation
- › Meets Higher EN/DIN Pressures
- › SAE J1942/U.S. Coast Guard

### Application

Medium-pressure hydraulic applications including mobile, machine tool and agricultural applications, using petroleum or water-based hydraulic fluids.

### Inner Tube

Nitrile

### Reinforcement

One braid of high-tensile steel wire

### Cover

Black polychloroprene

### Temperature Range

-40°F to 212°F (-40°C to 100°C)

### Fitting Reference

All fittings compatible with the SR1SN hose family are listed in Section 1 (starting on page 54) of the catalog.

### Branding

Example: Continental ContiTech SR1SN-03 SAE 100R1AT/1SN 3/16" (DN05) W.P. 3630 psi (25 MPa) MSHA 2G-14C/12

Descriptive #/ Product #	SAP #	Hose Size ID		Hose OD		Max. Working Pressure		Min. Bend Radius		Min. Burst Pressure		Weight lbs./ft.	USCG Approved
		in.	mm	in.	mm	psi	MPa	in.	mm	psi	MPa		
SR1SN-03	20239993	3/16	05	0.47	11.9	3630	25.0	3.5	89	14520	100.0	0.12	HF-A
SR1SN-04	20240216	1/4	06	0.53	13.6	3270	22.5	4.0	102	13080	90.2	0.15	HF-A
SR1SN-05	20240217	5/16	08	0.60	15.1	3120	21.5	4.5	114	12480	86.0	0.17	
SR1SN-06	20240218	3/8	10	0.69	17.5	2615	18.0	5.0	127	10460	72.1	0.22	HF-A
SR1SN-08	20240219	1/2	12	0.81	20.7	2320	16.0	7.0	178	9280	64.0	0.28	H
SR1SN-10	20240250	5/8	16	0.94	23.8	1890	13.0	8.0	203	7560	52.1	0.33	HF-A
SR1SN-12	20240251	3/4	19	1.10	27.8	1530	10.5	9.5	241	6120	42.2	0.41	HF-A
SR1SN-16	20240252	1	25	1.41	35.8	1280	8.8	12.0	305	5120	35.3	0.62	HF-A
SR1SN-20	20708462	1¼	31	1.70	43.1	920	6.3	16.5	419	3680	25.4	0.84	H
SR1SN-24	20706727	1½	38	1.98	50.3	730	5.0	20.0	508	2920	20.1	1.05	H
SR1SN-32	20706728	2	51	2.51	63.8	580	4.0	25.0	635	2320	16.0	1.48	H

# SFS

## SAE 100R1AT Fire Suppression | Medium Pressure



- › Meets Flame Resistance USMSHA Designation

### Application

Medium-pressure hydraulic applications including fire suppression actuation equipment where the red cover allows for easy identification.

### Inner Tube

Nitrile

### Reinforcement

One braid of high-tensile steel wire

### Cover

Red nitrile

### Temperature Range

-40°F to 212°F (-40°C to 100°C)

### Fitting Reference

All fittings compatible with the SFS hose family are listed in Section 1 (starting on page 54) of the catalog.

### Branding

Example: Continental ContiTech SFS -12 FIRE SUPPRESSION HOSE 3/4" (19mm) W.P. 1250 psi (8.6 MPa) MSHA 2G-1C-14C/31 MADE IN U.S.A.

Descriptive #/ Product #	SAP #	Hose Size ID		Hose OD		Max. Working Pressure		Min. Bend Radius		Min. Burst Pressure		Weight lbs./ft.
		in.	DIN Dash Size	in.	mm	psi	MPa	in.	mm	psi	MPa	
SFS -04	20276330	1/4	6.4	0.53	13.6	2750	19.0	4	102	11000	75.8	0.15
SFS -06	20276331	3/8	9.5	0.69	17.5	2250	15.5	5	127	9000	62.1	0.22
SFS -08	20276332	1/2	12.7	0.81	20.7	2000	13.8	7	178	8000	55.2	0.28
SFS -12	20276333	3/4	19.0	1.10	27.8	1250	8.6	9.5	241	5000	34.5	0.41
SFS -16	20276334	1	25.4	1.41	35.8	1000	6.9	12	305	4000	27.6	0.62

## Desert® DR1SN

## SAE 100R1AT/1SN | Medium Pressure



- › Meets or exceeds the performance requirements of: SAE 100R1AT; and the working pressure requirements of EN 853 1SN.
- › High Temperature
- › Meets Higher EN/DIN Pressures
- › Meets Flame Resistance USMSHA Designation
- › SAE J1942/U.S. Coast Guard

**Application**

Medium-pressure hydraulic oil lines used in mobile, machine tool and agricultural applications where higher temperature petroleum- or water-based hydraulic fluids are a factor.

**Inner Tube**

Black CPE

**Reinforcement**

One braid of high-tensile steel wire

**Cover**

Blue CPE

**Temperature Range**

-40°F to 302°F (-40°C to 150°C)

**Fitting Reference**

All fittings compatible with the DR1SN hose family are listed in Section 1 (starting on page 54) of the catalog.

**Branding**

Example: Continental ContiTech Desert® DR1SN-04 SAE 100R1AT/1SN (High temp) 1/4" (DN06) W.P. 3270 psi (22.5 MPa) MSHA 2G-IC-14C/42

Descriptive #/ Product #	SAP #	Hose Size ID		Hose OD		Max. Working Pressure		Min. Bend Radius		Min. Burst Pressure		Weight	USCG Approved
		in.	DIN Dash Size	in.	mm	psi	MPa	in.	mm	psi	MPa		
DR1SN-04	20786856	1/4	06	0.52	13.1	3270	22.5	4.0	102	13080	90.2	0.15	H
DR1SN-06	20777151	3/8	10	0.67	17.1	2615	18.0	5.0	127	10460	72.1	0.22	H
DR1SN-08	20752562	1/2	12	0.80	20.3	2320	16.0	7.0	178	9280	64.0	0.28	H
DR1SN-10	20777159	5/8	16	0.92	23.4	1890	13.0	8.0	203	7560	52.1	0.33	H
DR1SN-12	20780193	3/4	19	1.08	27.4	1530	10.5	9.5	241	6120	42.2	0.41	H
DR1SN-16	20777155	1	25	1.39	35.3	1280	8.8	12.0	305	5120	35.3	0.62	H
DR1SN-20	20776244	1¼	31	1.70	43.1	920	6.3	16.5	419	3680	25.2	0.84	
DR1SN-24	20776245	1½	38	1.97	50.1	730	5.0	20.0	508	2920	20.0	1.09	
DR1SN-32	20776246	2	51	2.50	63.6	580	4.0	25.0	635	2320	16.0	1.34	

## SR2SN

## SAE 100R2AT/2SN | High Pressure



- › Meets or exceeds the performance requirements of: SAE 100R2AT; EN 853 2SN.
- › Meets Flame Resistance USMSHA Designation
- › Meets Higher EN/DIN Pressures
- › ABS Type Approved 1/4" through 1"
- › SAE J1942/U.S. Coast Guard

**Application**

High-pressure hydraulic oil lines used in construction, machine tool and agricultural applications using petroleum- or water-based hydraulic fluids. Hose sizes 3/16" - 5/8" have a vacuum rating of 28 in Hg. Hose sizes 3/4" - 1" have a vacuum rating of 24 in Hg.

**Inner Tube**

Nitrile

**Reinforcement**

Two braids of high-tensile steel wire

**Cover**

Black polychloroprene

**Temperature Range**

-40°F to 212°F (-40°C to 100°C)

**Fitting Reference**

All fittings compatible with the SR2SN hose family are listed in Section 1 (starting on page 54) of the catalog.

**Branding**

Example: Continental ContiTech SR2SN-03 SAE 100R2AT/2SN 3/16" (DN05) W.P. 6000 psi (41.4 MPa) MSHA 2G-14C/12

Descriptive #/ Product #	SAP #	Hose Size ID		Hose OD		Max. Working Pressure		Min. Bend Radius		Min. Burst Pressure		Weight	USCG Approved
		in.	DIN Dash Size	in.	mm	psi	MPa	in.	mm	psi	MPa		
SR2SN-03	20240253	3/16	05	0.48	12.3	6000	41.3	3.5	89	24000	165.2	0.20	
SR2SN-04	20240254	1/4	06	0.59	15.1	5800	40.0	4.0	102	23200	160.0	0.24	HF-A
SR2SN-06	20276604	3/8	10	0.75	19.1	4800	33.1	5.0	127	19200	132.4	0.34	H
SR2SN-08	20270619	1/2	12	0.88	22.2	4000	27.6	7.0	178	16000	110.3	0.43	HF-A
SR2SN-10	20240257	5/8	16	1.00	25.4	3630	25.0	8.0	203	14520	100.0	0.50	
SR2SN-12	20240258	3/4	19	1.16	29.4	3120	21.5	9.5	241	12480	86.0	0.61	HF-A
SR2SN-16	20240259	1	25	1.50	38.1	2400	16.5	12.0	305	9600	66.2	0.88	HF-A
SR2SN-20	20239362	1¼	31	1.86	47.2	1820	12.5	16.5	419	7280	50.2	1.53	H
SR2SN-24	20239363	1½	38	2.11	54.1	1310	9.0	20.0	508	5240	36.1	1.64	H
SR2SN-32	20239364	2	51	2.62	66.7	1160	8.0	25.0	635	4640	32.0	2.02	H

# Desert® DR2SN

SAE 100R2AT | High Pressure



- › Meets or exceeds the performance requirements of SAE 100R2AT; EN853 2SN-pressures.
- › High Temperature
- › Meets Higher EN/DIN Pressures
- › Meets Flame Resistance USMSHA Designation
- › SAE J1942/U.S. Coast Guard 

### Application

High-pressure hydraulic oil lines used in construction, machine tool and agricultural applications where higher temperature petroleum- or water-based hydraulic fluids are a factor.

### Inner Tube

Black CPE

### Reinforcement

Two braids of high-tensile steel wire

### Cover

Blue CPE

### Temperature Range

-40°F to 302°F (-40°C to 150°C)

### Fitting Reference

All fittings compatible with the DR2SN hose family are listed in Section 1 (starting on page 54) of the catalog.

### Branding

Example: Continental ContiTech Desert® DR2SN-08 SAE 100R2AT 1/2" (DN12) 4000 psi (27.6 MPa) MSHA 2G-IC-14C/42

Descriptive #/ Product #	SAP #	Hose Size ID		Hose OD		Max. Working Pressure		Min. Bend Radius		Min. Burst Pressure		Weight	USCG Approved
		in.	DIN Dash Size	in.	mm	psi	MPa	in.	mm	psi	MPa		
DR2SN-04	20698338	1/4	08	0.59	15.1	5800	40.0	4.0	102	23200	160.0	0.24	H
DR2SN-06	20698339	3/8	10	0.75	19.1	4800	33.1	5.0	127	19200	132.4	0.34	H
DR2SN-08	20698620	1/2	12	0.88	22.2	4000	27.6	7.0	178	16000	110.3	0.43	H
DR2SN-10	20698621	5/8	16	1.00	25.4	3630	25.0	8.0	203	14520	100.0	0.50	H
DR2SN-12	20698622	3/4	19	1.16	29.4	3120	21.5	9.5	241	12480	86.0	0.61	H
DR2SN-16	20698623	1	25	1.50	38.1	2400	16.5	12.0	305	9600	66.6	0.88	H
DR2SN-20	20732342	1¼	31	1.88	47.7	1820	12.5	16.5	419	7280	50.0	1.52	
DR2SN-24	20732343	1½	38	2.13	54.1	1310	9.0	20.0	508	5240	36.0	1.64	
DR2SN-32	20732344	2	51	2.63	66.7	1160	8.0	25.0	635	4640	32.0	2.02	

# Arctic® LR2SN

SAE 100R2AT/2SN | High Pressure



- › Meets or exceeds the performance requirements of: SAE 100R2AT; EN 853 except -04.
- › Meets Flame Resistance USMSHA Designation
- › Meets Higher EN/DIN Pressures
- › Low Temperature

### Application

High-pressure hydraulic oil lines used in construction, machine tool and agricultural applications where lower temperature petroleum- or water-based hydraulic fluids are a factor.

### Inner Tube

Nitrile

### Reinforcement

Two braids of high-tensile steel wire

### Cover

Black polychloroprene

### Temperature Range

-58°F to 212°F (-50°C to 100°C)

### Fitting Reference

All fittings compatible with the LR2SN hose family are listed in Section 1 (starting on page 54) of the catalog.

### Branding

Example: Continental ContiTech Arctic® LR2SN-08 SAE 100R2AT.2SN (Low Temp) ½" (DN12) W.P. 4000 PSI (27.6 MPa) MSHA 2G-IC-14C/41

Descriptive #/ Product #	SAP #	Hose Size ID		Hose OD		Max. Working Pressure		Min. Bend Radius		Min. Burst Pressure		Weight
		in.	DIN Dash Size	in.	mm	psi	MPa	in.	mm	psi	MPa	
LR2AT-04*	20239365	1/4	06	0.58	14.7	5000	34.5	4.0	102	20000	138.0	0.24
LR2SN-06	20728489	3/8	10	0.74	18.7	4800	33.1	5.0	127	19200	132.4	0.34
LR2SN-08	20728510	1/2	12	0.86	21.8	4000	27.6	7.0	178	16000	110.3	0.43
LR2SN-10	20728511	5/8	16	0.99	25.0	3630	25.0	8.0	203	14520	100.0	0.50
LR2SN-12	20728512	3/4	19	1.14	29.0	3120	21.5	9.5	241	12480	86.0	0.61
LR2SN-16	20728513	1	25	1.48	37.6	2400	16.5	12.0	305	9600	66.2	0.88
LR2SN-20	20757165	1¼	31	1.88	47.7	1820	12.5	16.5	419	7280	50.0	1.52
LR2SN-24	20757167	1½	38	2.13	54.1	1310	9.0	20.0	508	5240	36.0	1.64
LR2SN-32	20757168	2	51	2.63	66.7	1160	8.0	25.0	635	4640	32.0	2.02

\*LR2AT-04 working pressure does not meet SAE 100R2AT.

## SR16SC

## SAE 100R16/EN 857 2SC | High Pressure



Tight Bends &amp; Flexible

› Meets or exceeds the performance requirements of: SAE 100R16; EN 857 2SC

› Meets Flame Resistance USMSHA Designation

› Meets Higher EN/DIN Pressures

› SAE J1942/U.S. Coast Guard 

**Application**

High-pressure service with tight bends for petroleum- and water-based hydraulic fluids. Excellent impulse performance and flexibility exceeding SAE 100R2 and SAE 100R16 standards.

**Inner Tube**

Nitrile

**Reinforcement**

Two braids of high-tensile steel wire

**Cover**

Black polychloroprene

**Temperature Range**

-40°F to 212°F (-40°C to 100°C)

**Fitting Reference**

All fittings compatible with the SR16SC hose family are listed in Section 1 (starting on page 54) of the catalog.

**Branding**

Example: Continental ContiTech SR16SC-04 SAE 100R16/EN 857 2SC 1/4" (DN06) W.P. 5800 psi (40 MPa) MSHA 2G-14C/12

Descriptive #/ Product #	SAP #	Hose Size ID		Hose OD		Max. Working Pressure		Min. Bend Radius		Min. Burst Pressure		Weight lbs./ft.	USCG Approved
		in.	DIN Dash Size	in.	mm	psi	MPa	in.	mm	psi	MPa		
SR16SC-04	20494340	1/4	06	0.54	13.7	5800	40.0	2.0	51	23200	160.0	0.18	H
SR16SC-06	20436685	3/8	10	0.70	17.7	5000	34.5	2.5	64	20000	137.9	0.27	H
SR16SC-08	20263798	1/2	12	0.81	20.6	5000	34.5	3.5	89	20000	137.9	0.36	H
SR16SC-10	20264959	5/8	16	0.95	24.2	4000	27.6	4.0	102	16000	110.3	0.41	H
SR16SC-12	20239475	3/4	19	1.10	28.0	3500	24.1	5.0	127	14000	96.5	0.55	H
SR16SC-16	20483278	1	25	1.40	35.5	3000	18.6	6.0	152	12000	74.5	0.83	H
SR16SC-20	20666436	1 1/4	31	1.74	44.3	1813	12.5	8.3	210	7252	50.0	1.12	

## Desert® DR16SC

## SAE 100R16 | High Pressure



› Meets or exceeds the performance requirements of: SAE 100R16; except -04.

› Meets Flame Resistance USMSHA Designation

› SAE J1942/U.S. Coast Guard 

› Meets EN 857 2SC working pressures; except -04

**Application**

High-pressure service with tight bends for petroleum- and water-based hydraulic fluids. For high temperature applications.

**Inner Tube**

CPE

**Reinforcement**

Two braids of high-tensile steel wire

**Cover**

Blue CPE

**Temperature Range**

-40°F to 302°F (-40°C to 150°C)

**Fitting Reference**

All fittings compatible with the DR16SC hose family are listed in Section 1 (starting on page 54) of the catalog.

**Branding**

Example: Continental ContiTech DR16SC-06 SAE 100R16 3/8" (DN10) WP 5000PSI 34.5MPa 345 Bar MSHA 2G-IC-14C/42

Descriptive #/ Product #	SAP #	Hose Size ID		Hose OD		Max. Working Pressure		Min. Bend Radius		Min. Burst Pressure		Weight lbs./ft.	USCG Approved
		in.	DIN Dash Size	in.	mm	psi	MPa	in.	mm	psi	MPa		
DR16-04*	20778355	1/4	6	0.54	18.8	5075	35.0	2.0	20300	140.0	0.23	H	
DR16SC-06	20755831	3/8	10	0.70	17.8	5000	34.5	2.5	20000	138.0	0.33	H	
DR16SC-08	20755835	1/2	12	0.82	20.9	4500	34.5	3.5	20000	137.9	0.43	H	
DR16SC-12	20755850	3/4	19	1.10	28.0	3500	24.1	5.0	14000	96.5	0.61	H	
DR16SC-16	20776987	1	25	1.42	35.9	3000	18.6	6.0	12000	74.4	0.94	H	

\*DR16-04 working pressure does not meet SAE 100R16.



## Extended Life XR16SC

SAE 100R16/EN 857 2SC | High Pressure



Tight Bends & Flexible

- › Meets or exceeds the performance requirements of: SAE 100R16; EN 857 2SC
- › Meets Flame Resistance USMSHA Designation
- › Meets Higher EN/DIN Pressures
- › SAE J1942/U.S. Coast Guard

### Application

High-pressure service needing abrasion resistance, tight bends and flexible. For petroleum- and water-based hydraulic fluids. Excellent impulse performance and flexibility exceeding SAE 100R2 and SAE 100R16 standards.

### Inner Tube

Nitrile

### Reinforcement

Two braids of high-tensile steel wire

### Cover

Extra abrasion, oil and weather resistant synthetic rubber

### Temperature Range

-40°F to 212°F (-40°C to 100°C)

### Fitting Reference

All fittings compatible with the XR16SC™ hose family are listed in Section 1 (starting on page 54) of the catalog.

### Branding

Example: Continental ContiTech Extended Life XR16SC-08 SAE 100R16/EN 857 2SC 1/2" (DN12) W.P. 5000 psi (34.5 MPa) MSHA 2G IC-14C/37

Descriptive #/ Product #	SAP #	Hose Size ID		Hose OD		Max. Working Pressure		Min. Bend Radius		Min. Burst Pressure		Weight lbs./ft.	USCG Approved
		in.	DIN Dash Size	in.	mm	psi	MPa	in.	mm	psi	MPa		
XR16SC-04	20693982	1/4	06	0.54	13.70	5800	40.0	2.0	51	23200	160.0	0.18	H
XR16SC-06	20693983	3/8	10	0.70	17.70	5000	34.5	2.5	64	20000	137.9	0.27	H
XR16SC-08	20693984	1/2	12	0.81	20.60	5000	34.5	3.5	89	20000	137.9	0.36	H
XR16SC-10	20693985	5/8	16	0.95	24.20	4000	27.6	4.0	102	16000	110.3	0.41	H
XR16SC-12	20693987	3/4	19	1.10	28.00	3500	24.1	5.0	127	14000	96.5	0.55	H
XR16SC-16	20693988	1	25	1.40	35.50	3000	20.68	6.0	152	12000	82.74	0.83	H

## ARMORCOAT™ ARC16SC

SAE 100R16/EN 857 2SC | High Pressure



- › Meets or exceeds the performance requirements of: SAE 100R16; EN 857 2SC
- › Meets Flame Resistance USMSHA Designation
- › Meets Higher EN/DIN Pressures
- › Abrasion Cover

### Application

High-pressure service with tight bends for petroleum- and water-based hydraulic fluids where maximum abrasion resistance is required. Excellent impulse performance and flexibility exceeding SAE 100R2 and SAE 100R16 standards.

### Inner Tube

Nitrile

### Reinforcement

Two braids of high-tensile steel wire

### Cover

Black synthetic rubber with ARMORCOAT™

### Temperature Range

-40°F to 212°F (-40°C to 100°C)

### Fitting Reference

All fittings compatible with the ARC16SC hose family are listed in Section 1 (starting on page 54) of the catalog.

### Branding

Example: Continental ContiTech ARMORCOAT™ ARC16SC-04 SAE 100R16/EN 857 2SC (Abrasion cover) 1/4" (DN06) W.P. 5800 psi (40 MPa) MSHA 2G-IC-14C/43

Descriptive #/ Product #	SAP #	Hose Size ID		Hose OD		Max. Working Pressure		Min. Bend Radius		Min. Burst Pressure		Weight lbs./ft.
		in.	DIN Dash Size	in.	mm	psi	MPa	in.	mm	psi	MPa	
ARC16SC-04	20731686	1/4	06	0.52	13.2	5800	40.0	2.0	51	23200	160.0	0.17
ARC16SC-06	20731831	3/8	10	0.67	17.0	5000	34.5	2.5	64	20000	137.9	0.26
ARC16SC-08	20730593	1/2	12	0.81	20.6	5000	34.5	3.5	89	20000	137.9	0.35
ARC16SC-10	20733777	5/8	16	0.92	23.4	4000	27.6	4.0	102	16000	110.3	0.40
ARC16SC-12	20733779	3/4	19	1.08	27.4	3500	24.1	5.0	127	14000	96.5	0.54
ARC16SC-16	20731835	1	25	1.40	35.5	3000	18.6	6.0	152	12000	74.5	0.83

## SCP3

## SAE 100R17 | Constant Pressure | High Pressure

**Application**

High-pressure hydraulic applications designed to replace SAE 100R1 where higher pressures and a more flexible hose are required.

**Inner Tube**

Nitrile

**Reinforcement**

One braid of high-tensile steel wire. Sizes 5/8", 3/4" and 1" 2-wire braid

**Cover**

Oil and weather resistant synthetic rubber

**Temperature Range**

-40°F to 212°F (-40°C to 100°C)

**Fitting Reference**

All fittings compatible with the SCP3 hose family are listed in Section 1 (starting on page 54) of the catalog.

**Branding**

Branding Example: Continental ContiTech SCP3-04 SAE 100R17 ¼" (6.4 mm) W.P. 3000 PSI (20.7 MPa) MSHA 2G-14C/12"

- › Meets or exceeds the performance requirements of: SAE 100R17
- › Meets Flame Resistance USMSHA Designation
- › SAE J1942/U.S. Coast Guard 

Descriptive #/ Product #	SAP #	Hose Size ID		Hose OD		Max. Working Pressure		Min. Bend Radius		Min. Burst Pressure		Weight lbs./ft.	USCG Approved
		in.	mm	in.	mm	psi	MPa	in.	mm	psi	MPa		
SCP3-04	20318573	1/4	6.4	0.50	12.7	3045	21	2.0	51	12180	84	0.11	H
SCP3-06	20317756	3/8	9.5	0.65	16.5	3045	21	2.5	64	12180	84	0.17	H
SCP3-08	20618576	1/2	12.7	0.78	19.8	3045	21	3.5	89	12180	84	0.28	H
SCP3-10	20239486	5/8	15.9	0.95	24.1	3045	21	4.0	102	12180	84	0.41	H
SCP3-12	20470795	3/4	19.0	1.13	28.7	3045	21	5.0	127	12180	84	0.55	H
SCP3-12	20329003	1	25.4	1.44	36.6	3045	21	6.0	152	12180	84	0.82	H

## Extended Life XCP3

## SAE 100R17 | Constant Pressure | High Pressure

**Application**

High-pressure hydraulic applications needing abrasion resistance designed to replace SAE 100R1 where higher pressures and a more flexible hose are required.

**Inner Tube**

Nitrile

**Reinforcement**

One braid of high-tensile steel wire. Sizes 5/8", ¾" and 1" 2-wire braid

**Cover**

Extra abrasion, oil & weather resistant synthetic rubber (More than 5 times the abrasion resistance over SCP3)

**Temperature Range**

-40°F to 212°F (-40°C to 100°C)

**Fitting Reference**

All fittings compatible with the XCP3 hose family are listed in Section 1 (starting on page 54) of the catalog.

**Branding**

Example: Continental ContiTech Extended Life XCP3-08 SAE100R17 Abrasion Cover ½" (DN12) 3045 PSI (21 MPA, 210 BAR) MSHA 2G-1C-14C/37 Made in U.S.A.

- › Meets or exceeds the performance requirements of: SAE 100R17
- › Meets Flame Resistance USMSHA Designation
- › SAE J1942/U.S. Coast Guard 
- › Extended Life Abrasion Resistant Cover

Descriptive #/ Product #	SAP #	Hose Size ID		Hose OD		Max. Working Pressure		Min. Bend Radius		Min. Burst Pressure		Weight lbs./ft.	USCG Approved
		in.	mm	in.	mm	psi	MPa	in.	mm	psi	MPa		
XCP3-04	20738196	1/4	6.4	0.50	12.7	3045	21	2.0	51	12180	84	0.11	H
XCP3-06	20784065	3/8	9.5	0.65	16.5	3045	21	2.5	64	12180	84	0.17	H
XCP3-08	20774712	1/2	12.7	0.78	19.8	3045	21	3.5	89	12180	84	0.28	H
XCP3-10	20777228	5/8	15.9	0.95	24.1	3045	21	4.0	102	12180	84	0.41	H
XCP3-12	20777501	3/4	19.0	1.13	28.7	3045	21	5.0	127	12180	84	0.55	H
XCP3-16	20774714	1	25.4	1.44	36.6	3045	21	6.0	152	12180	84	0.82	H

## ARMORCOAT™ ACP3

SAE 100R17 | High Pressure



- › Meets or exceeds the performance requirements of: SAE 100R17
- › Meets Flame Resistance USMSHA Designation
- › Abrasion Cover

### Application

High-pressure hydraulic applications designed to replace SAE 100R1 where higher pressures, increased flexibility and maximum abrasion resistance are required.

### Inner Tube

Nitrile

### Reinforcement

One braid of high-tensile steel wire

### Cover

Black Synthetic Rubber with ARMORCOAT™

### Temperature Range

-40°F to 212°F (-40°C to 100°C)

### Fitting Reference

All fittings compatible with the ACP3 hose family are listed in Section 1 (starting on page 54) of the catalog.

### Branding

Example: Continental ContiTech ACP3-04 SAE 100R17 (Abrasion Cover) ¼" (6.4 mm) W.P. 3045 PSI (21.0 MPa) MSHA 2G-IC-14C/43

Descriptive #/ Product #	SAP #	Hose Size ID		Hose OD		Max. Working Pressure		Min. Bend Radius		Min. Burst Pressure		Weight lbs./ft.
		in.	mm	in.	mm	psi	MPa	in.	mm	psi	MPa	
ACP3-04	20706539	1/4	6.6	0.50	12.8	3045	21.0	2.0	51	12180	84.0	0.11
ACP3-06	20706643	3/8	9.7	0.65	16.5	3045	21.0	2.5	64	12180	84.0	0.17
ACP3-08	20706648	1/2	12.9	0.79	19.9	3045	21.0	3.5	89	12180	84.0	0.28
ACP3-10	20870407	5/8	15.9	0.95	24.1	3045	21.0	5.0	127	12180	84.0	0.41

## Extended Life XCP4 SAE 100R19/ISO 11237 | Constant Pressure | Very High Pressure



- › Meets or exceeds the performance requirements of SAE 100R19 and ISO 11237
- › Meets Flame Resistance of USMSHA Designation
- › SAE J1942/U.S. Coast Guard Pending
- › ABS Pending
- › Extended Life Abrasion Resistant Cover

### Application

Very high pressure hydraulic applications requiring extra abrasion resistance. Excellent impulse performance and flexibility meeting SAE 100R19 and ISO 11237 standards.

### Inner Tube

Nitrile

### Reinforcement

Two braids of high-tensile steel wire

### Cover

Superior abrasion, oil & weather resistant synthetic rubber

### Temperature Range

-40°F to 212°F (-40°C to 100°C)

### Fitting Reference

All fittings compatible with the XCP4™ hose family are listed in Section 1 (starting on page 54) of the catalog.

### Branding

Example: Continental ContiTech Extended Life XCP4-08 SAE 100R19 1/2" ISO 11237/ R19/12.5 4060 PSI (28.0 MPa, 280 BAR) MSHA 2G-IC-14C/37 MADE IN USA

Descriptive #/ Product #	SAP #	Hose Size ID		Hose OD		Max. Working Pressure		Min. Bend Radius		Min. Burst Pressure		Weight lbs./ft.
		in.	mm	in.	mm	psi	MPa	in.	mm	psi	MPa	
XCP4-04	20827919	1/4	6.4	0.54	13.8	4060	28	2.0	50.8	16240	112	0.26
XCP4-06	20826087	3/8	9.5	0.69	17.6	4060	28	2.5	63.5	16240	112	0.30
XCP4-08	20828100	1/2	12.7	0.82	20.9	4060	28	3.5	88.9	16240	112	0.42
XCP4-10	20828101	5/8	15.9	0.95	24.2	4060	28	4.0	101.6	16240	112	0.48
XCP4-12	20826123	3/4	19.0	1.14	29.0	4060	28	5.0	127.0	16240	112	0.66

## SR12

## SAE 100R12/EN 856 R12 | Very High Pressure



1/2 Bend 3/8" - 3/4"

- › Meets or exceeds the performance requirements of: SAE 100R12; EN 856 R12
- › Meets Flame Resistance USMSHA Designation
- › SAE J1942/U.S. Coast Guard 
- › ABS Type Pending

**Application**

Very high-pressure applications subject to surges or flexing such as oil and gas, construction equipment, mining and the high-performance industrial market.

**Inner Tube**

Polychloroprene

**Reinforcement**

Four alternating layers of spiralled high-tensile steel wire

**Cover**

Black Polychloroprene

**Temperature Range**

-40°F to 250°F (-40°C to 121°C)

**Fitting Reference**

All fittings compatible with the SR12 hose family are listed in Section 3 (starting on page 107) of the catalog.

**Branding**

Example: Continental ContiTech SR12-06 SAE 100R12/EN 856 R12 3/8 (DN10) W.P. 4100 PSI (28.0 MPa) MSHA 2G-IC-14C/44

Descriptive #/ Product #	SAP #	Hose Size ID		Hose OD		Max. Working Pressure		Min. Bend Radius		Min. Burst Pressure		Weight lbs./ft.	USCG Approved
		in.	mm	in.	mm	psi	MPa	in.	mm	psi	MPa		
SR12-06	20703115	3/8	10	0.80	20.3	4100	28.0	2.5	65	16400	112	0.40	H
SR12-08	20703046	1/2	12	0.94	23.8	4100	28.0	3.5	90	16400	112	0.52	H
SR12-10	20703117	5/8	16	1.08	27.4	4100	28.0	4.0	100	16400	112	0.70	H
SR12-12	20703048	3/4	19	1.21	30.7	4100	28.0	4.7	120	16400	112	0.81	H
SR12-16	20693294	1	25	1.50	38.0	4100	28.0	11.8	300	16400	112	1.20	H
SR12-20	20703118	1¼	31	1.85	47.0	3050	21.0	16.5	420	12200	84	1.70	H
SR12-24	20703119	1½	38	2.10	53.5	2550	17.5	19.7	500	10200	70	2.05	H
SR12-32	20693298	2	51	2.60	66.7	2550	17.5	25.0	635	10200	70	2.82	H

## ARMORCOAT™ ARC12

## SAE 100R12/EN 856 R12 | Very High Pressure



1/2 Bend 3/8" - 3/4"

- › Meets or exceeds the performance requirements of: SAE 100R12; EN 856 R12
- › Meets Flame Resistance USMSHA Designation
- › Abrasion Cover

**Application**

Very high-pressure applications subject to surges or flexing such as construction equipment, mining and the high-performance industrial market where maximum abrasion resistance is required.

**Inner Tube**

Polychloroprene

**Reinforcement**

Four alternating layers of spiralled high-tensile steel wire

**Cover**

Black Synthetic Rubber with ARMORCOAT™

**Temperature Range**

-40°F to 250°F (-40°C to 121°C)

**Fitting Reference**

All fittings compatible with the ARC12 hose family are listed in Section 3 (starting on page 107) of the catalog.

**Branding**

Example: Continental ContiTech ARMORCOAT™ ARC12-06 SAE 100R12/EN 856 R12 (Abrasion Cover) 3/8" (DN10) W.P. 4100 PSI (28.0 MPa) MSHA 2G-IC-14C/43

Descriptive #/ Product #	SAP #	Hose Size ID		Hose OD		Max. Working Pressure		Min. Bend Radius		Min. Burst Pressure		Weight lbs./ft.
		in.	mm	in.	mm	psi	MPa	in.	mm	psi	MPa	
ARC12-06	20729168	3/8	10	0.80	20.2	4100	28.0	2.5	64	16400	112	0.44
ARC12-08	20715104	1/2	12	0.94	23.8	4100	28.0	3.5	90	16400	112	0.55
ARC12-10	20729176	5/8	16	1.11	28.2	4100	28.0	3.9	100	16400	112	0.72
ARC12-12	20715106	3/4	19	1.21	30.7	4100	28.0	4.7	120	16400	112	0.82
ARC12-16	20715107	1	25	1.50	38.0	4100	28.0	11.8	300	16400	112	1.21
ARC12-20	20729173	1¼	31	1.85	47.0	3050	21.0	16.5	420	12200	84	1.65
ARC12-24	20729174	1½	38	2.10	53.4	2550	17.6	19.7	500	10200	70	2.19
ARC12-32	20729175	2	51	2.63	66.7	2550	17.6	25.0	635	10200	70	3.13

# SR13

## SAE 100R13/EN 856 R13 | Very High Pressure



### Application

Very high-pressure applications subject to surges or flexing such as construction equipment, mining and the high-performance industrial market.

### Reinforcement

Four alternating layers of spiralled high-tensile steel wire (sizes 3/4" and 1") and six alternating layers of spiralled high-tensile steel wire (sizes 1 1/4", 1 1/2" and 2")

### Fitting Reference

All fittings compatible with the SR13 hose family are listed in Section 4 (starting on page 148) of the catalog.

› Meets or exceeds the performance requirements of: SAE 100R13; EN 856 R13

› Meets Flame Resistance USMSHA Designation

› SAE J1942/U.S. Coast Guard 

› ABS Type Pending

### Inner Tube

Polychloroprene

### Cover

Black polychloroprene

### Temperature Range

-40°F to 250°F (-40°C to 121°C)

### Branding

Example: Continental ContiTech SR13-12 SAE 100R13/EN 856 R13 3/4" (DN19) W.P. 5100 PSI (35.0 MPa) MSHA 2G-IC-14C/44

Descriptive #/ Product #	SAP #	Hose Size ID		Hose OD		Max. Working Pressure		Min. Bend Radius		Min. Burst Pressure		Weight lbs./ft.	USCG Approved
		in.	mm	in.	mm	psi	MPa	in.	mm	psi	MPa		
SR13-12	20704441	3/4	19	1.26	32.1	5100	35.0	9.4	240	20400	140.7	1.09	H
SR13-16	20704442	1	25	1.52	38.7	5100	35.0	11.8	300	20400	140.7	1.42	H
SR13-20	20704443	1 1/4	31	1.96	49.8	5100	35.0	16.5	420	20400	140.7	2.69	H
SR13-24	20704449	1 1/2	38	2.25	57.3	5100	35.0	19.7	500	20400	140.7	3.35	H
SR13-32	20704450	2	51	2.80	71.1	5100	35.0	25.2	640	20400	140.7	4.93	H

# ARMORCOAT™ ARC13

## SAE 100R13/EN 856 R13 | Very High Pressure



### Application

Very high-pressure applications subject to surges or flexing such as construction equipment, mining and the high-performance industrial market where maximum abrasion resistance is required.

### Reinforcement

Four alternating layers of spiralled high-tensile steel wire (3/4" and 1") and six alternating layers of spiralled high-tensile steel wire (size 1 1/4", 1 1/2" and 2")

### Fitting Reference

All fittings compatible with the ARC13 hose family are listed in Section 4 (starting on page 148) of the catalog. Note: No Continental ContiTech fitting recommendation on ARC13-10 hose size.

› Meets or exceeds the performance requirements of: SAE 100R13; EN 856 R13 (all sizes)

› Meets Flame Resistance USMSHA Designation

› Abrasion Cover

### Inner Tube

Polychloroprene

### Cover

Black Synthetic Rubber with ARMORCOAT™

### Temperature Range

-40°F to 250°F (-40°C to 121°C)

### Branding

Example: Continental ContiTech ARMORCOAT™ ARC13-12 SAE 100R13/EN 856 R13 (Abrasion Cover) 3/4" (DN19) W.P. 5100 PSI (35.0 MPa) MSHA 2G-IC-14C/43

Descriptive #/ Product #	SAP #	Hose Size ID		Hose OD		Max. Working Pressure		Min. Bend Radius		Min. Burst Pressure		Weight lbs./ft.
		in.	mm	in.	mm	psi	MPa	in.	mm	psi	MPa	
ARC13-12	20715111	3/4	19	1.26	32.1	5100	35.0	9.5	240	20400	140	0.97
ARC13-16	20715112	1	25	1.51	38.5	5100	35.0	11.8	305	20400	140	1.30
ARC13-20	20715113	1 1/4	31	1.96	49.8	5100	35.0	16.5	420	20400	140	1.73
ARC13-24	20715114	1 1/2	38	2.26	57.3	5100	35.0	19.7	500	20400	140	3.27
ARC13-32	20715115	2	51	2.80	71.1	5100	35.0	25.2	640	20400	140	4.43

## SR15

## SAE 100R15 | Very High Pressure

**Application**

Designed specifically to handle severe high-pressure applications where pressure spikes or constant hydrostatic loads are present.

**Inner Tube**

Polychloroprene

**Reinforcement**

Four alternating layers of spiralled high-tensile steel wire (sizes 1/2", 5/8", 3/4" and 1") and six alternating layers of spiralled high-tensile steel wire (sizes 1¼" and 1½")

**Cover**

Black polychloroprene

**Temperature Range**

-40°F to 250°F (-40°C to 121°C)

**Fitting Reference**

All fittings compatible with the SR15 hose family are listed in Section 4 (starting on page 148) of the catalog. Note: No Continental ContiTech fitting recommendation on SR15-08 and SR15-10 hose sizes.

**Branding**

Example: Continental ContiTech SR15-08 SAE 100R15 1/2" (12.7mm) W.P. 6100 PSI (42.0 MPa) MSHA 2G-IC-14C/44

- › Meets or exceeds the performance requirements of: SAE 100R15
- › Meets Flame Resistance USMSHA Designation
- › SAE J1942/U.S. Coast Guard Pending
- › ABS Type Pending

Descriptive #/ Product #	SAP #	Hose Size ID		Hose OD		Max. Working Pressure		Min. Bend Radius		Min. Burst Pressure		Weight	USCG Pending
		in.	mm	in.	mm	psi	MPa	in.	mm	psi	MPa		
SR15-08	20714800	1/2	12	0.95	24.2	6100	42.0	7.9	200	24400	168.0	0.59	
SR15-12	20714785	3/4	19	1.26	32.0	6100	42.0	10.4	265	24400	168.0	1.09	
SR15-16	20714793	1	25	1.53	38.8	6100	42.0	13.0	330	24400	168.0	1.46	
SR15-20	20714794	1¼	32	1.89	48.0	6100	42.0	17.5	445	24400	168.0	2.41	
SR15-24	20714795	1½	38	2.23	56.8	6100	42.0	20.9	530	24400	168.0	3.02	

## ARMORCOAT™ ARC15

## SAE 100R15 | Very High Pressure

**Application**

Designed specifically to handle severe high-pressure applications where pressure spikes or constant hydrostatic loads are present and maximum abrasion resistance is required.

**Inner Tube**

Polychloroprene

**Reinforcement**

Four alternating layers of spiralled high-tensile steel wire

**Cover**

Black Synthetic Rubber with ARMORCOAT™

**Temperature Range**

-40°F to 250°F (-40°C to 121°C)

**Fitting Reference**

All fittings compatible with the ARC15 hose family are listed in Section 4 (starting on page 148) of the catalog. Note: No Continental ContiTech fitting recommendation on ARC15-08 hose size.

**Branding**

Example: Continental ContiTech ARMORCOAT™ ARC15-08 SAE 100R15 (Abrasion Cover) 1/2" (12.7mm) W.P. 6100 PSI (42.0 MPa) MSHA 2G-IC-14C/43

- › Meets or exceeds the performance requirements of: SAE 100R15
- › Meets Flame Resistance USMSHA Designation
- › Abrasion Cover

Descriptive #/ Product #	SAP #	Hose Size ID		Hose OD		Max. Working Pressure		Min. Bend Radius		Min. Burst Pressure		Weight
		in.	mm	in.	mm	psi	MPa	in.	mm	psi	MPa	
ARC15-08	20714906	1/2	12.7	1.06	26.8	6100	42.0	8.0	200	24400	168.0	0.59
ARC15-12	20714907	3/4	19.0	1.27	32.2	6100	42.0	10.5	265	24400	168.0	1.08
ARC15-16	20714908	1	25.4	1.53	38.8	6100	42.0	13.0	330	24400	168.0	1.48

# S4SP

## EN 856 4SP/DIN 20023 4SP | Very High Pressure



### Application

Very high-pressure applications used for petroleum-based hydraulic fluids.

### Reinforcement

Four alternating layers of spiralled high-tensile steel wire

### Fitting Reference

All fittings compatible with the S4SP hose family are listed in Section 4 (starting on page 148) of the catalog.

- › Meets or exceeds the performance requirements of: EN 856 4SP; DIN 20023 4SP
- › Meets Flame Resistance USMSHA Designation
- › ABS Type Pending

### Inner Tube

Polychloroprene

### Cover

Black polychloroprene

### Temperature Range

-40°F to 212°F (-40°C to 100°C)

### Branding

Example: Continental ContiTech S4SP-06 EN 856 4SP 3/8" (DN10) W.P. 6455 PSI (45.0 MPa) MSHA 2G-IC-14C/44

Descriptive #/ Product #	SAP #	Hose Size ID		Hose OD		Max. Working Pressure		Min. Bend Radius		Min. Burst Pressure		Weight
		in.	mm	in.	mm	psi	MPa	in.	mm	psi	MPa	
S4SP-06	20714777	3/8	10	0.84	21.4	6455	45.0	7.1	180	25820	178	0.51
S4SP-08	20714778	1/2	12	0.97	24.6	6020	41.5	9.0	230	24080	166	0.58
S4SP-10	20714779	5/8	16	1.11	28.2	5075	35.0	9.8	250	20300	140	0.73
S4SP-12	20714771	3/4	19	1.27	32.2	5510	38.0	11.8	300	22040	152	0.98
S4SP-16	20714773	1	25	1.56	39.7	4640	32.0	13.4	340	18560	128	1.30

# S4SH

## EN 856 4SH/DIN 20023 4SH | Very High Pressure



### Application

Very high-pressure, pulsating applications used for petroleum-based hydraulic fluids.

### Reinforcement

Four alternating layers of spiralled high-tensile steel wire

### Fitting Reference

All fittings compatible with the S4SH hose family are listed in Section 4 (starting on page 148) of the catalog.

- › Meets or exceeds the performance requirements of: EN 856 4SH; DIN 20023 4SH
- › Meets Flame Resistance USMSHA Designation
- › ABS Type Pending

### Inner Tube

Polychloroprene

### Cover

Black polychloroprene

### Temperature Range

-40°F to 212°F (-40°C to 100°C)

### Branding

Example: Continental ContiTech S4SH-12 EN 856 4SH 3/4" (DN19) W.P. 6090 PSI (42.0 MPa) MSHA 2G-IC-14C/44

Descriptive #/ Product #	SAP #	Hose Size ID		Hose OD		Max. Working Pressure		Min. Bend Radius		Min. Burst Pressure		Weight
		in.	mm	in.	mm	psi	MPa	in.	mm	psi	MPa	
S4SH-12	20706576	3/4	19	1.27	32.2	6090	42.0	11.0	280	24360	168.0	1.09
S4SH-16	20706577	1	25	1.52	38.7	5510	38.0	13.4	340	22040	152.0	1.42
S4SH-20	20706723	1 1/4	31	1.79	45.5	5080	35.0	17.9	455	20320	140.0	1.71
S4SH-24	20706724	1 1/2	38	2.11	53.5	4205	29.0	22.0	560	16820	116.0	2.19
S4SH-32	20706725	2	51	2.68	68.1	3650	25.0	28.0	710	14600	100.7	3.31

## SR7

## SAE 100R7/EN 855 R7 | Thermoplastic



Exceeds SAE Min. Bend Radius

- › Meets or exceeds the performance requirements of: SAE 100R7; EN 855 R7

**Application**

Medium-pressure thermoplastic hose with a perforated cover. Compatible with petroleum-, water- and synthetic-based fluids for mobile equipment, lube lines, blowout preventers, hydraulic lifts and construction machinery.

**Inner Tube**

Nylon

**Reinforcement**

Synthetic fiber

**Cover**

Black urethane, perforated

**Temperature Range**

-40°F to 212°F (-40°C to 100°C)  
Note: Max temperature for water-based and fire-resistant fluids is 150°F (66°C).

**Fitting Reference**

All fittings compatible with the SR7 hose family are listed in Section 2 (starting on page 91) of the catalog.

**Branding**

Example: Continental ContiTech SR7-02 SAE 100R7/EN855 R7 1/8" (DN03) W.P. 2500 psi (17.2 MPa)

Descriptive #/ Product #	SAP #	Hose Size ID		Hose OD		Max. Working Pressure		Min. Bend Radius		Min. Burst Pressure		Weight
		in.	mm	in.	mm	psi	MPa	in.	mm	psi	MPa	
SR7-02	20243607	1/8	03	0.34	8.5	2500	17.2	0.5	13	10000	68.9	0.03
SR7-03	20243608	3/16	05	0.43	10.8	3000	20.7	0.8	20	12000	82.7	0.05
SR7-04	20243609	1/4	06	0.51	13.0	3000	20.7	1.3	33	12000	82.7	0.06
SR7-05	20243650	5/16	08	0.59	15.1	2500	17.2	1.8	46	10000	68.9	0.07
SR7-06	20243651	3/8	10	0.67	17.0	2250	15.5	2.0	51	9000	62.1	0.10
SR7-08	20243652	1/2	12	0.82	20.7	2000	13.8	3.0	76	8000	55.2	0.14
SR7-12	20243653	3/4	19	1.07	27.1	1250	8.6	5.0	127	5000	34.5	0.19
SR7-16	20243654	1	25	1.34	34.0	1000	6.9	8.0	203	4000	27.6	0.26

## TR7

## SAE 100R7 (Twin-Line) | Thermoplastic



- › Meets or exceeds the performance requirements of: SAE 100R7
- › Twin-Line

**Application**

Medium-pressure, twin-line thermoplastic hose with a perforated cover. Compatible with petroleum-, water- and synthetic-based fluids for mobile equipment, lube lines, blowout preventers, hydraulic lifts and construction machinery.

**Inner Tube**

Nylon

**Reinforcement**

Synthetic fiber

**Cover**

Black urethane, perforated

**Temperature Range**

-40°F to 212°F (-40°C to 100°C)  
Note: Max temperature for water-based and fire-resistant fluids is 150°F (66°C).

**Fitting Reference**

All fittings compatible with the TR7 hose family are listed in Section 2 (starting on page 91) of the catalog.

**Branding**

Example: Continental ContiTech TR7-03 SAE 100R7 3/16" (4.8mm) W.P. 3000 psi (20.7 MPa)

Descriptive #/ Product #	SAP #	Hose Size ID		Hose OD		Max. Working Pressure		Min. Bend Radius		Min. Burst Pressure		Weight
		in.	mm	in.	mm	psi	MPa	in.	mm	psi	MPa	
TR7-03	20243663	3/16	4.8	0.43	10.8	3000	20.7	0.8	20	12000	82.7	0.09
TR7-04	20243664	1/4	6.4	0.51	13.0	3000	20.7	1.3	33	12000	82.7	0.11
TR7-05	20243665	5/16	7.9	0.59	15.1	2500	17.2	1.8	46	10000	68.9	0.14
TR7-06	20243666	3/8	9.5	0.67	17.0	2250	15.5	2.0	51	9000	62.1	0.19
TR7-08	20243667	1/2	12.7	0.82	20.7	2000	13.8	3.0	76	8000	55.2	0.28



# NR7

## SAE 100R7 (Non-Conductive) | Thermoplastic



- › Meets or exceeds the performance requirements of: SAE 100R7;
- › Non-Conductive

**Application**  
Medium-pressure thermoplastic hose with a non-perforated cover. Compatible with petroleum-, water- and synthetic-based fluids for mobile equipment, lube lines, blowout preventers, hydraulic lifts and construction machinery requiring SAE 100R7 non-conductivity standards.

**Inner Tube**  
Polyester

**Reinforcement**  
Synthetic fiber

**Cover**  
Orange urethane

**Temperature Range**  
-65°F to 212°F (-54°C to 100°C)  
Note: Temperature range is -40°F to 200°F (-40°C to 93°C) for sizes 1/8", 3/4" and 1". Max. temperature for water-based and fire-resistant fluids is 140°F (60°C).

**Fitting Reference**  
All fittings compatible with the NR7 hose family are listed in Section 2 (starting on page 91) of the catalog.

**Branding**  
Example: Continental ContiTech NR7-02 SAE 100R7 (Non-Conductive) 1/8" (3.3mm) W.P. 2500 psi (17.2 MPa)

Descriptive #/ Product #	SAP #	Hose Size ID		Hose OD		Max. Working Pressure		Min. Bend Radius		Min. Burst Pressure		Weight lbs./ft.
		in.	mm	in.	mm	psi	MPa	in.	mm	psi	MPa	
NR7-02	20243655	1/8	3.3	0.34	8.5	2500	17.2	0.5	13	10000	68.9	0.03
NR7-03	20243656	3/16	4.8	0.43	10.8	3000	20.7	0.8	20	12000	82.7	0.05
NR7-04	20243657	1/4	6.4	0.49	12.3	2750	19.0	1.3	33	11000	75.8	0.06
NR7-05	20243658	5/16	7.9	0.58	14.7	2500	17.2	1.8	46	10000	68.9	0.08
NR7-06	20243659	3/8	9.5	0.64	16.1	2250	15.5	2.0	51	9000	62.1	0.10
NR7-08	20243660	1/2	12.7	0.82	20.7	2250	15.5	3.0	76	9000	62.1	0.14
NR7-12	20243661	3/4	19.0	1.07	27.1	1250	8.6	5.0	127	5000	34.5	0.19
NR7-16	20243662	1	25.4	1.34	34.0	1000	6.9	8.0	203	4000	27.6	0.26

# BR7

## SAE 100R7 (Twin-Line, Non-Conductive) | Thermoplastic



- › Meets or exceeds the performance requirements of: SAE 100R7
- › Twin-Line
- › Non-Conductive

**Application**  
Medium-pressure, twin-line thermoplastic hose with a non-perforated cover. Compatible with petroleum-, water- and synthetic-based fluids for mobile equipment, lube lines, blowout preventers, hydraulic lifts and construction machinery requiring SAE 100R7 non-conductivity standards.

**Inner Tube**  
Polyester

**Reinforcement**  
Synthetic fiber

**Cover**  
Orange urethane

**Temperature Range**  
-65°F to 212°F (-54°C to 100°C)  
Note: Max temperature for water-based and fire-resistant fluids is 150°F (66°C).

**Fitting Reference**  
All fittings compatible with the BR7 hose family are listed in Section 2 (starting on page 91) of the catalog.

**Branding**  
Example: Continental ContiTech BR7-04 SAE 100R7 (Non-Conductive) 1/4" (6.4mm) W.P. 2750 psi (19 MPa)

Descriptive #/ Product #	SAP #	Hose Size ID		Hose OD		Max. Working Pressure		Min. Bend Radius		Min. Burst Pressure		Weight lbs./ft.
		in.	mm	in.	mm	psi	MPa	in.	mm	psi	MPa	
BR7-04	20243684	1/4	6.4	0.49	12.3	2750	19.0	1.3	33	11000	75.8	0.12
BR7-05	20243685	5/16	7.9	0.58	14.7	2500	17.2	1.8	46	10000	68.9	0.15
BR7-06	20243686	3/8	9.5	0.64	16.1	2250	15.5	2.0	51	9000	62.1	0.19
BR7-08	20243687	1/2	12.7	0.82	20.7	2250	15.5	3.0	76	9000	62.1	0.29

## SR8

## SAE 100R8/EN 855 R8 | Thermoplastic



Exceeds SAE Min. Bend Radius

- Meets or exceeds the performance requirements of: SAE 100R8; EN 855 R8

**Application**

High-pressure thermoplastic hose with a perforated cover for petroleum-, water- and synthetic-based fluids for mobile equipment, lube lines, blowout preventers, hydraulic lifts and construction machinery.

**Inner Tube**

Nylon

**Reinforcement**

Synthetic fiber

**Cover**

Black urethane, perforated

**Temperature Range**

-40°F to 212°F (-40°C to 100°C)  
Note: Max temperature for water-based and fire-resistant fluids is 150°F (66°C).

**Fitting Reference**

All fittings compatible with the SR8 hose family are listed in Section 2 (starting on page 91) of the catalog.

**Branding**

Example: Continental ContiTech SR8-03 SAE 100R8/EN 855 R8 3/16" (DN05) W.P. 5000 psi (34.5 MPa)

Descriptive #/ Product #	SAP #	Hose Size ID		Hose OD		Max. Working Pressure		Min. Bend Radius		Min. Burst Pressure		Weight lbs./ft.
		in.	mm	in.	mm	psi	MPa	in.	mm	psi	MPa	
SR8-03	20243672	3/16	05	0.52	13.1	5000	34.5	1.5	38	20000	137.9	0.08
SR8-04	20243673	1/4	06	0.63	15.9	5000	34.5	2.0	51	20000	137.9	0.12
SR8-06	20243674	3/8	10	0.77	19.4	4000	27.6	2.5	64	16000	110.3	0.15
SR8-08	20243675	1/2	12	0.89	22.7	3500	24.1	4.0	102	14000	96.5	0.19

## TR8

## SAE 100R8 (Twin-Line) | Thermoplastic



- Meets or exceeds the performance requirements of: SAE 100R8
- Twin-Line

**Application**

High-pressure, twin-line thermoplastic hose with a perforated cover. Compatible with petroleum-, water- and synthetic-based fluids for mobile equipment, lube lines, blowout preventers, hydraulic lifts and construction machinery.

**Inner Tube**

Nylon

**Reinforcement**

Synthetic fiber

**Cover**

Black urethane, perforated

**Temperature Range**

-40°F to 212°F (-40°C to 100°C)  
Note: Max temperature for water-based and fire-resistant fluids is 150°F (66°C).

**Fitting Reference**

All fittings compatible with the TR8 hose family are listed in Section 2 (starting on page 91) of the catalog.

**Branding**

Example: Continental ContiTech TR8-06 SAE 100R8 3/8" (9.5mm) W.P. 4000 psi (27.6 MPa)

Descriptive #/ Product #	SAP #	Hose Size ID		Hose OD		Max. Working Pressure		Min. Bend Radius		Min. Burst Pressure		Weight lbs./ft.
		in.	mm	in.	mm	psi	MPa	in.	mm	psi	MPa	
TR8-06	20243679	3/8	9.5	0.77	19.4	4000	27.6	2.5	64	16000	110.3	0.30
TR8-08	20416222	1/2	12.7	0.89	22.7	3500	24.1	4.0	102	14000	96.5	0.38

# NR8

## SAE 100R8 (Non-Conductive) | Thermoplastic



- › Meets or exceeds the performance requirements of: SAE 100R8
- › Non-Conductive

### Application

High-pressure thermoplastic hose with a non-perforated cover. Compatible with petroleum-, water- and synthetic-based fluids for mobile equipment, lube lines, blowout preventers, hydraulic lifts and construction machinery requiring SAE 100R8 non-conductivity standards.

### Inner Tube

Nylon

### Reinforcement

Synthetic fiber

### Cover

Orange urethane

### Temperature Range

-40°F to 212°F (-40°C to 100°C)  
Note: Max temperature for water-based and fire-resistant fluids is 150°F (66°C).

### Fitting Reference

All fittings compatible with the NR8 hose family are listed in Section 2 (starting on page 91) of the catalog.

### Branding

Example: Continental ContiTech NR8-04 SAE 100R8 (Non-conductive) 1/4" (6.4mm) W.P. 5000 psi (34.5 MPa)

Descriptive #/ Product #	SAP #	Hose Size ID		Hose OD		Max. Working Pressure		Min. Bend Radius		Min. Burst Pressure		Weight
		in.	mm	in.	mm	psi	MPa	in.	mm	psi	MPa	
NR8-04	20243676	1/4	6.4	0.63	15.9	5000	34.5	2.0	51	20000	137.9	0.12
NR8-06	20243677	3/8	9.5	0.77	19.4	4000	27.6	2.5	64	16000	110.3	0.15
NR8-08	20243678	1/2	12.7	0.89	22.7	3500	24.1	4.0	102	14000	96.5	0.19

# SR18

## SAE 100R18 | Thermoplastic



Flexible at Low Temp

- › Meets or exceeds the performance requirements of: SAE 100R18
- › Low Temperature

### Application

Thermoplastic hose, highly flexible even in cold temperatures. Compact size with a small OD and lightweight yet rugged construction. Applications for this hose include forklifts, construction equipment, general hydraulic applications, chemical and gas transfer, agricultural equipment, material handling, freezer applications, machine tools and robotics, lubrication equipment and portable hydraulic tools.

### Inner Tube

Polyester

### Reinforcement

Synthetic fiber

### Cover

Polyester

### Temperature Range

-40°F to 212°F (-40°C to 100°C)  
Note: Max temperature for water-based and fire-resistant fluids is 150°F (66°C)

### Fitting Reference

All fittings compatible with the SR18 hose family are listed in Section 2 (starting on page 91) of the catalog.

### Branding

Example: Continental ContiTech SR18-04 SAE 100R18 1/4" (6.4mm) W.P. 3000 psi (20.7 MPa)

Descriptive #/ Product #	SAP #	Hose Size ID		Hose OD		Max. Working Pressure		Min. Bend Radius		Min. Burst Pressure		Weight
		in.	mm	in.	mm	psi	MPa	in.	mm	psi	MPa	
SR18-04	20243680	1/4	6.4	0.49	12.3	3000	20.7	1.3	32	12000	82.7	0.06
SR18-05	20243681	5/16	7.9	0.61	15.5	3000	20.7	1.5	38	12000	82.7	0.08
SR18-06	20243682	3/8	9.5	0.66	16.8	3000	20.7	2.0	51	12000	82.7	0.12
SR18-08	20243683	1/2	12.7	0.85	21.6	3000	20.7	3.5	89	12000	82.7	0.15

## NSFX

## SAFLEX® | Special Application



› Non-Conductive

**Application**

Medium-pressure applications where shock hazards exist and non-conductivity is required. Meets max leakage of 100 microamps/ft. at 75 KV for 3 minutes.

**Inner Tube**

Polychloroprene

**Reinforcement**

Two textile braids

**Cover**

Orange nitrile

**Temperature Range**

-40°F to 212°F (-40°C to 100°C)

**Fitting Reference**

All fittings compatible with the NSFX hose family are listed in Section 7 (starting on page 252) of the catalog.

**Branding**

Example: Continental ContiTech NSFX-04 SAFLEX® (Non-conductive) 1/4" (6.4mm) W.P. 2750 psi (19 MPa)

Descriptive #/ Product #	SAP #	Hose Size ID		Hose OD		Max. Working Pressure		Min. Bend Radius		Min. Burst Pressure		Weight
		in.	mm	in.	mm	psi	MPa	in.	mm	psi	MPa	
NSFX-04	20240283	1/4	6.4	0.56	14.2	2750	19.0	3.5	89	11000	75.8	0.11
NSFX-06	20240284	3/8	9.5	0.75	19.0	2250	15.5	4.0	102	9000	62.1	0.19
NSFX-08	20240285	1/2	12.7	0.94	23.7	2000	13.8	6.0	152	8000	55.2	0.27

## Prospector™ SHR

## Slim-Hole Rotary Hose | Special Application



› Meets Flame Resistance USMSHA Designation

**Application**

High-pressure, rotary hose for slim-hole, seismograph, work-over or portable drilling rigs. For use with small- to medium-blast, water-well or shot-hole drilling applications. Used in hydraulic oil, mud or air applications or where pulsating pump is required.

**Inner Tube**

Polychloroprene

**Reinforcement**

Four alternating layers of spiralled high-tensile steel wire for the

SHR5000-16 (1") and SHR3650-32 (2"). Six alternating layers of spiralled high-tensile steel wire for the SHR5000-20 (1¼") through SHR5000-32 (2")

**Cover**

Polychloroprene, Pin Pricked

**Temperature Range**

When conveying air: -40°F to 158°F (-40°C to 70°C). When conveying fluids: -40°F to 250°F (-40°C to 121°C). When conveying fluids for SHR3650-32 : -40°F to 212°F (-40°C to 100°C)

**Fitting Reference**

All fittings compatible with the Prospector™ Slim-Hole Rotary hose family are listed in Section 7 (starting on page 252) of the catalog.

**Branding**

Example: Continental ContiTech Prospector™ Slim-Hole Rotary 1" 5000 psi W.P. Flame Resistant MSHA 2G-IC-14C/44"

**Safety Factor**

4:1 Safety Factor

Descriptive #/ Product #	SAP #	Hose Size ID		Hose OD		Max. Working Pressure		Min. Bend Radius		Min. Burst Pressure		Weight
		in.	mm	in.	mm	psi	MPa	in.	mm	psi	MPa	
SHR3000-32	20749438	2	50.8	2.69	68.3	3000	20.7	25.0	635	12000	82.7	1.34
SHR3650-32	20714905	2	50.8	2.74	69.7	3650	25.2	28.0	710	14600	100.7	2.40
SHR5000-16	20714808	1	25.4	1.57	39.8	5000	34.5	11.8	300	20000	138.0	3.35
SHR5000-20	20714890	1¼	31.8	2.02	51.3	5000	34.5	16.5	420	20000	138.0	4.38
SHR5000-24	20714903	1½	38.1	2.31	58.8	5000	34.5	19.7	500	20000	138.0	3.13
SHR5000-32	20714904	2	50.8	2.9	72.7	5000	34.5	24.8	630	20000	138.0	4.27

# Prospector™ BOP 3000

Special Application



Fire Tested

**Application**

BOP hose is a hydraulic control connection that is used in the well control system.

**Inner Tube**

Black nitrile

**Reinforcement**

2-Wire braid steel

**Cover**

Pink polychloroprene, wrapped finish

**Temperature Range**

-40°F to 212°F (-40°C to 100°C)

**Verification**

Independently tested per Lloyd's Register Fire Tests for Flexible Hoses on Offshore Installations.

Register Fire Tests for Flexible Hoses on Offshore Installations™ (OD/1000/499-29th June, 1992) and EUB (Directive 036)

**Fitting Reference**

Special assembly procedure required. Contact Continental ContiTech for details.

Descriptive #/ Product #	SAP #	Hose Size ID		Hose OD		Max. Working Pressure		Min. Bend Radius		Min. Burst Pressure		Weight
		in.	mm	in.	mm	psi	MPa	in.	mm	psi	MPa	
BOP-06	20613999	3/8	9.5	1.11	28.2	3000	20.7	6.0	152	12000	82.7	0.75
BOP-08	20614010	1/2	12.7	1.19	30.2	3000	20.7	8.0	203	12000	82.7	0.81
BOP-12	20614011	3/4	19.1	1.49	37.8	3000	20.7	11.0	279	12000	82.7	1.22
BOP-16	20614012	1	25.4	1.84	46.7	3000	20.7	15.0	381	12000	82.7	1.74

# Prospector™ BOP 5000

Very High Pressure



Fire Tested

**Application**

BOP hose is a hydraulic control connection that is used in the well control system.

**Inner Tube**

Polychloroprene

**Reinforcement**

Four alternating layers of spiral high-tensile steel wire (size 3/8", 1/2", 3/4", 1", 1 1/4") and six alternating layers of spiraled high-tensile steel wire (size 1 1/2" and 2")

**Cover**

Pink polychloroprene, wrapped finish

**Temperature Range**

-40°F to 212°F (-40°C to 100°C)

**Branding**

Example: Continental ContiTech BOP 5000 3/8" (9.5mm) W.P. 5000 psi (34.5 MPa)

**Fitting Reference**

Special assembly procedure required. Contact Continental ContiTech.

**Verification**

Tested at South West Research Institute and certified by Lloyd's Register to API Specification 16D (Spec 16D, Section 10)

Descriptive #/ Product #	SAP #	Hose Size ID		Hose OD		Max. Working Pressure		Min. Bend Radius		Min. Burst Pressure		Weight
		in.	mm	in.	mm	psi	MPa	in.	mm	psi	MPa	
BOP5000-06	20715121	3/8	10.0	1.14	29.0	5000	34.5	7.1	180	20000	138.0	0.80
BOP5000-08	20715122	1/2	12.5	1.24	31.6	5000	34.5	9.0	230	20000	138.0	0.90
BOP5000-12	20715123	3/4	19.0	1.58	40.1	5000	34.5	11.8	300	20000	138.0	1.60
BOP5000-16	20715124	1	25.0	1.85	46.9	5000	34.5	13.4	340	20000	138.0	2.00
BOP5000-20	20715125	1 1/4	31.5	2.10	53.4	5000	34.5	18.1	460	20000	138.0	2.40
BOP5000-24	20715126	1 1/2	38.0	2.59	65.9	5000	34.5	19.7	500	20000	138.0	4.10
BOP5000-32	20715127	2	51.0	3.14	79.7	5000	34.5	24.8	630	20000	138.0	5.50

## Prospector™ Hot Oiler

### Special Application



#### Application

Static pressure, hot oiler applications. Designed specifically to handle the transfer of hot oil at 275° continuous, 300°F intermittent to clear the paraffin around the casing to help start the flow of oil to the surface.

› Meets Flame Resistance USMSHA Designation

#### Inner Tube

Black, oil resistant, synthetic rubber.

#### Reinforcement

Two braids of high-tensile steel wire

#### Cover

Black, oil and abrasion resistant, synthetic rubber.

#### Temperature Range

-40°F to 275°F (-40°C to 135°C)

#### Fitting Reference

All fittings compatible with this Hot Oiler hose are listed in Section 7 (starting on page 252) of the catalog. Parts include:  
S4-NPM-API-2424 (SAP#20636530)  
S4-IHUF1502-2432 (SAP#20815350)  
S4-IHUM1502-2432 (SAP#20815351)

#### Branding

Continental ContiTech HOT OILER

Descriptive #/ Product #	SAP #	Hose Size ID		Hose OD		Max. Working Pressure		Min. Bend Radius		Min. Burst Pressure		Weight
		in.	mm	in.	mm	psi	MPa	in.	mm	psi	MPa	
Hot Oiler	20739324	1½	38.0	2.16	54.8	2500	17.2	20.0	508	8750	60.3	1.64

## SGUN

### Grease Gun Hose | Special Application



#### Application

Used as a grease whip hose or general purpose lubrication line. To be used with hand grease guns only. Not for powered units.

› Meets Flame Resistance USMSHA Designation

#### Inner Tube

Nitrile

#### Reinforcement

One braid of high-tensile steel wire

#### Cover

Black polychloroprene

#### Temperature Range

-40°F to 212°F (-40°C to 100°C)

#### Fitting Reference

All fittings compatible with the SGUN hose family are listed in Section 7 (starting on page 252) of the catalog.

#### Branding

Example: Continental ContiTech SGUN-03 Grease Gun Hose 3/16" (4.8mm) W.P. 3000 psi (20.7 MPa) MSHA 2G-14C/12

Descriptive #/ Product #	SAP #	Hose Size ID		Hose OD		Max. Working Pressure		Min. Bend Radius		Min. Burst Pressure		Weight
		in.	mm	in.	mm	psi	MPa	in.	mm	psi	MPa	
SGUN-03	20240286	3/16	4.8	0.41	10.4	3000	20.7	NA	NA	12000	82.7	0.09

## SHJ

## Jack Hose | Special Application



- › Meets Flame Resistance USMSHA Designation

**Application**

Extreme high-pressure hydraulic lines for jacking systems.

**Inner Tube**

Nitrile

**Reinforcement**

Two braids of high-tensile steel wire

**Cover**

Black polychloroprene

**Temperature Range**

-40°F to 212°F (-40°C to 100°C)

**Fitting Reference**

All fittings compatible with the SHJ hose family are listed in Section 7 (starting on page 252) of the catalog.

**Branding**

Example: Continental ContiTech SHJ-04 Jack Hose 1/4" (6.4mm) W.P. 10000 psi (68.9 MPa) MSHA 2G-14C/12

Descriptive #/ Product #	SAP #	Hose Size ID		Hose OD		Max. Working Pressure		Min. Bend Radius		Min. Burst Pressure		Weight
		in.	mm	in.	mm	psi	MPa	in.	mm	psi	MPa	
SHJ-04	20319601	1/4	6.4	0.58	14.7	10000	68.9	4.0	102	20000	137.9	0.24
SHJ-06	20319602	3/8	9.5	0.74	18.7	10000	68.9	5.0	127	20000	137.9	0.30

## SR14A

## SAE 100R14A | Fleet &amp; Special Application



- › Meets or exceeds the performance requirements of: SAE 100R14A; FDA 21 CFR 177, 1500 Specifications
- › High Temperature
- › Chemical Resistant

**Application**

Medium-pressure hydraulic applications including truck, bus, industrial and aerospace. Compatible with air, fuel, lubricants, high-temp oil and some chemical applications.

**Inner Tube**

Polytetrafluoroethylene

**Cover/Reinforcement**

304 stainless steel wire braid

**Temperature Range**

-65°F to 450°F (-54°C to 232°C)  
continuous -100°F to 500°F  
(-73°C to 260°C) intermittent

**Fitting Reference**

Hose utilizes UCF9 ferrules with Continental ContiTech Uni-Crimp® stems, see Section 5 (starting on page 187) of the catalog.

**Branding**

N/A

Descriptive #/ Product #	SAP #	Hose Size ID		Hose OD		Max. Working Pressure		Min. Bend Radius		Min. Burst Pressure		Weight
		in.	mm	in.	mm	psi	MPa	in.	mm	psi	MPa	
SR14A-03	20303683	3/16	4.8	0.31	7.9	3000	20.7	2.0	51	12000	82.7	0.06
SR14A-04	20303665	1/4	6.4	0.38	9.5	3000	20.7	3.0	76	12000	82.7	0.08
SR14A-05	20303667	5/16	7.9	0.45	11.3	2500	17.2	4.0	102	10000	69.0	0.09
SR14A-06	20303669	3/8	9.5	0.50	12.8	2250	15.5	4.5	114	9000	62.1	0.11
SR14A-08	20303691	1/2	12.7	0.65	16.5	1500	10.3	6.5	165	6000	41.4	0.15
SR14A-10	20303693	5/8	15.9	0.78	19.8	1200	8.3	7.7	196	4800	33.1	0.19
SR14A-12	20303695	3/4	19.1	0.89	22.5	1100	7.6	8.2	208	4400	30.3	0.21
SR14A-16	20303697	1	25.4	1.14	28.8	900	6.2	10.0	254	3600	24.8	0.32

# SR5

## SAE 100R5 | Fleet Application



### Application

General-purpose, medium-pressure hose, for use in air brakes, power steering, turbo oil lines, tilt cab cylinders, transmission coolant and filtration lines. Compatible with petroleum-based hydraulic fluids, air, water, gasoline and diesel fuel (GR-04 through -20 only), lubricating oils and coolants.

Note: Not recommended for under-the-hood, automotive and truck fuel line applications. Only hoses designed and tested to meet SAE fuel line standards should be used for these applications.

Note: Sizes 7/8", 1 1/8", 1 3/8" and 1 3/16" do not meet SAE J1402 Type All & DOT FMVSS 106 Type All because these sizes are not listed in the referenced specifications.

### Inner Tube

Nitrile

### Reinforcement

One braid of high-tensile steel wire

### Cover

Black impregnated textile braid

### Temperature Range

-40°F to 212°F (-40°C to 100°C)

### Fitting Reference

All fittings compatible\*\*\* with the SR5 hose family are listed in Section 6 (starting on page 217) of the catalog.

### Branding

Example: Continental ContiTech SR5-04 5 mm (3/16") SAE 100R5 (DOT FMVSS 106 All, J1402 Air Brake) 20.7 MPa (3000 psi) W.P. GY Made in U.S.A.

Descriptive #/ Product #	SAP #	Hose Size ID		Hose OD		Max. Working Pressure		Min. Bend Radius		Min. Burst Pressure		Weight lbs./ft.	USCG Approved
		in.	mm	in.	mm	Psi	MPa	in.	mm	Psi	MPa		
SR5-04	20324155	3/16	4.8	0.52	13.2	3000	20.7	3.0	76	12000	82.7	0.15	H
SR5-05	20416026	1/4	6.4	0.58	14.8	3000	20.7	3.4	86	12000	82.7	0.18	H
SR5-06	20324042	5/16	7.9	0.68	17.1	2250	15.5	4.0	102	9000	62.1	0.22	H
SR5-08	20324041	13/32	10.3	0.77	19.5	2000	13.8	4.6	117	8000	55.2	0.30	H
SR5-10	20326081	1/2	12.7	0.92	23.4	1750	12.1	5.5	140	7000	48.3	0.37	H
SR5-12	20455110	5/8	15.9	1.08	27.4	1500	10.3	6.5	165	6000	41.4	0.45	H
SR5-16	20340597	7/8	22.2	1.24	31.4	800	5.5	7.4	187	3200	22.1	0.47	H
SR5-20	20239407	1 1/8	28.6	1.50	38.1	625	4.3	9.0	229	2500	17.2	0.58	H

\*\*\*Note: Assemblies made with Continental ContiTech's SR5 hose and Continental ContiTech's Field-Grip® or Uni-Crimp® fittings meet SAE J1402 and DOT FMVSS 571.106 specifications. Assemblies made with Uni-Crimp fittings also meet SAE J517 100R5 assembly requirements. USCG rating "H" requires GTEX protective sleeving. Federal law requires registration with the Department of Transportation for anyone producing air brake hose assemblies.



› Meets or exceeds the performance requirements of: SAE 100R5; DOT FMVSS 106 All and SAE J1402 (sizes 3/16", 1/4", 5/16", 13/32", 1/2" and 5/8")

› SAE J1942/U.S. Coast Guard



## Desert® DR5

### SAE 100R5 | Fleet Application



› Meets or exceeds the performance requirements of: SAE 100R5; SAE J1402 Type AII, DOT FMVSS 106 Type AII

› High Temperature

› SAE J1942/U.S. Coast Guard 

#### Application

High-temperature, medium pressure hose for use in applications including turbocharger oil lines, tilt cab cylinder and air brake lines, transmission coolant and filtration lines. Compatible with petroleum oil and phosphate ester-based hydraulic fluids, air, water, diesel fuel, petroleum based lubricating oils and coolants.

Note: Not recommended for under-the-hood, automotive and truck fuel line applications. Only hoses designed and tested to meet SAE fuel line standards should be used for these applications.

Note: Sizes 7/8" (-16) and 1 1/8" (-20) do not meet SAE J1402 Type AII & DOT FMVSS 106 Type AII because these sizes are not listed in the referenced specifications.

#### Inner Tube

CPE

#### Reinforcement

One braid textile, one braid steel

#### Cover

Blue impregnated textile braid

#### Temperature Range

SAE 100R5 Hydraulic Applications: -40°F to 302°F (-40°C to 150°C)

Air Brake Applications: -40°F to 200°F (-40°C to 93°C)

General Hot Oil Applications: -40°F to 302°F (-40°C to 150°C)

General Air Applications: -40°F to 200°F (-40°C to 93°C)

Water Applications: -40°F to 212°F (-40°C to 100°C)

#### Fitting Reference

All fittings compatible\*\*\* with the DR5 hose family are listed in Section 6 (starting on page 217) of the catalog.

#### Branding

Example: Continental ContiTech DR5-06 SAE 8 mm (5/16") SAE 100R5 (DOT FMVSS 106 AII, J1402 AIR BRAKE) 15.5 MPa (2250 psi) W.P. GY Made in U.S.A.

Descriptive #/ Product #	SAP #	Hose Size ID		Hose OD		Max. Working Pressure		Min. Bend Radius		Min. Burst Pressure		Weight lbs./ft.	USCG Approved
		in.	mm	in.	mm	psi	MPa	in.	mm	psi	MPa		
DR5-04	20340705	3/16	4.8	0.52	13.2	3000	20.7	3.0	76	12000	82.7	0.15	H
DR5-05	20341023	1/4	6.4	0.58	14.8	3000	20.7	3.4	86	12000	82.7	0.18	H
DR5-06	20340706	5/16	7.9	0.68	17.1	2250	15.5	4.0	102	9000	62.1	0.22	H
DR5-08	20340707	13/32	10.3	0.77	19.5	2000	13.8	4.5	117	8000	55.2	0.30	H
DR5-10	20340708	1/2	12.7	0.92	23.4	1750	12.1	5.5	140	7000	48.3	0.37	H
DR5-12	20341025	5/8	15.9	1.08	27.4	1500	10.3	6.5	165	6000	41.4	0.45	H
DR5-16	20340709	7/8	22.2	1.24	31.4	800	5.5	7.4	187	3200	22.1	0.47	H
DR5-20	20368015	1 1/8	28.6	1.50	38.1	625	4.3	9.0	229	2500	17.2	0.58	H

\*\*\*Note: Assemblies made with Continental ContiTech's DR5 hose and Continental ContiTech' Field Grip® or Uni-Crimp® fittings meet SAE J1402 and DOT FMVSS 571.106 specifications. For high-pressure hydraulic applications use the Uni-Crimp® fitting which meets SAE J517 100R5 assembly requirements. Federal law requires registration with the Department of Transportation for anyone producing air brake hose assemblies.

## SCX5

SAE 100R5 | Fleet Application

**Application**

For use with medium-pressure applications including water, gasoline, diesel, lubricating oils and petroleum-based hydraulic oils.

**Inner Tube**

Nitrile

**Reinforcement**

One braid steel wire and one braid textile

**Cover**

Black polychloroprene

**Temperature Range**

-40°F to 212°F (-40°C to 100°C)

**Fitting Reference**

The SCX5 hose family utilizes the UC Crimp Fittings listed in Section 6 (starting on page 217) of the catalog.

**Branding**

Example: Continental ContiTech SCX5-05 1/4" (6.4 mm) 3000 psi W.P. (20.7 MPa) MSHA 2G-14C/12 Made in U.S.A.

Descriptive #/ Product #	SAP #	Hose Size ID		Hose OD		Max. Working Pressure		Min. Bend Radius		Min. Burst Pressure		Weight lbs./ft.	USCG Approved
		in.	mm	in.	mm	psi	MPa	in.	mm	psi	MPa		
SCX5-05	20608834	1/4	6.4	0.58	14.8	3000	20.7	3.4	86	12000	82.7	0.18	H
SCX5-06	20608835	5/16	7.9	0.68	17.3	2250	15.5	4.0	102	9000	62.1	0.22	H
SCX5-08	20608836	13/32	10.3	0.78	19.8	2000	13.8	4.6	117	8000	55.2	0.23	H
SCX5-10	20608837	1/2	12.7	0.91	23.0	1750	12.1	5.5	140	7000	48.3	0.34	H
SCX5-12	20608838	5/8	15.9	1.08	27.4	1500	10.3	6.5	165	6000	41.4	0.41	H
SCX5-16	20608839	7/8	22.2	1.23	31.3	800	5.5	7.4	188	3200	22.1	0.44	H
SCX5-20	20608890	1 1/4	28.6	1.50	38.1	625	4.3	9.0	229	2500	17.2	0.53	H



## Desert® DUT

### SAE J1402 | Universal Truck | Fleet Application



- › Meets or exceeds the performance requirements of: SAE J1402 Type A1 DOT FMVSS 106 Type A1
- › High Temperature

#### Application

High-temperature, medium-pressure hose for use in applications including turbocharger oil lines, tilt cab cylinder and air brake lines, transmission coolant and filtration lines. Compatible with petroleum oil and phosphate ester-based hydraulic fluids, air, water, diesel fuel, petroleum-based lubricating oils and coolants.

Note: Not recommended for under-the-hood, automotive and truck fuel line applications. Only hoses designed and tested to meet SAE fuel line standards should be used for these applications.

Note: Sizes 7/8" (-16) and 1 1/8" (-20) do not meet SAE J1402 Type A1 & DOT FMVSS 106 Type A1 because these sizes are not listed in the referenced specifications.

#### Inner Tube

CPE

#### Reinforcement

One braid textile, one braid steel

#### Cover

Blue impregnated textile braid

#### Temperature Range

Air Brake Applications: -40°F to 200°F (-40°C to 93°C)

General Hot Oil Applications: -40°F to 302°F (-40°C to 150°C)

General Air Applications: -40°F to 200°F (-40°C to 93°C)  
Water Applications: -40°F to 212°F (-40°C to 100°C)

#### Fitting Reference

All fittings compatible with the Desert® DUT hose family are listed in Section 6A (starting on page 246) of the catalog.

#### Branding

Example: Continental ContiTech Desert® DUT-06 SAE J1402 Type A1 Air Brake DOT FMVSS 106 A1 5/16" (7.9mm) W.P. 1500 psi (10.3 MPa)

Descriptive #/ Product #	SAP #	Hose Size ID		Hose OD		Max. Working Pressure		Min. Bend Radius		Min. Burst Pressure		Weight lbs./ft.
		in.	mm	in.	mm	psi	MPa	in.	mm	psi	MPa	
DUT-04	20367570	3/16	4.8	0.49	12.4	2000	13.8	2.0	51	8000	55.2	0.12
DUT-05	20367574	1/4	6.4	0.55	14.0	1500	10.3	2.5	64	6000	41.4	0.14
DUT-06	20367576	5/16	7.9	0.62	15.7	1500	10.3	3.0	76	6000	41.4	0.17
DUT-08	20367577	13/32	10.3	0.74	18.8	1250	8.6	3.5	89	5000	34.5	0.20
DUT-10	20367578	1/2	12.7	0.83	21.1	1000	6.9	4.0	102	4000	27.6	0.22
DUT-12	20367579	5/8	15.9	0.96	24.4	750	5.2	4.5	114	3000	20.7	0.24
DUT-16	20424721	7/8	22.2	1.21	30.7	400	2.8	5.0	127	1600	11.0	0.30
DUT-20	20424722	1 1/8	28.6	1.49	37.8	300	2.1	5.5	140	1200	8.3	0.44

Note: Federal law requires registration with the Department of Transportation for anyone producing air brake hose assemblies.

## Galaxy® G4826

SAE J2064 | Air Conditioning



### Application

Recommended for R134a and R12 refrigerants in automotive, heavy-duty truck, construction and agricultural air conditioning systems.

### Inner Tube

Chloroprene

### Barrier

Nylon

### Reinforcement

Two-spiral polyester

### Cover

Black Chlorobutyl (CIIR)

### Temperature Range

-22°F to 257°F (-30°C to 125°C)

### Fitting Reference

All fittings compatible with the G4826 hose family are listed in Section 8 (starting on page 263) of the catalog.

### Branding

Example: Galaxy® by Continental ContiTech SAE J2064 Type C Class II 13/32" ID (10mm) 4826 - Size 8

Descriptive #/ Product #	SAP #	Hose Size ID		Hose OD		Max. Working Pressure		Min. Bend Radius		Min. Burst Pressure		Weight
		in.	mm	in.	mm	psi	MPa	in.	mm	psi	MPa	
G4826-06	20290026	5/16	7.9	0.75	19.1	500	3.4	0.6	16	2000	13.8	0.20
G4826-08	20290027	13/32	10.3	0.91	23.0	500	3.4	1.0	25	2000	13.8	0.28
G4826-10	20290028	1/2	12.7	1.00	25.4	500	3.4	1.3	32	2000	13.8	0.33
G4826-12	20290029	5/8	15.9	1.13	28.6	350	2.4	2.0	50	1750	12.1	0.38

## Galaxy® G4867

SAE J2064 | Air Conditioning



### Application

Recommended for R134a, refrigerant blends and compressor lubricants as a suction line in air conditioning systems for heavy-duty truck.

### Inner Tube

Chloroprene

### Barrier

Nylon

### Reinforcement

Single-braid polyester

### Cover

Black Chlorobutyl (CIIR)

### Temperature Range

-22°F to 257°F (-30°C to 125°C)

### Fitting Reference

All fittings compatible with the G4867 hose family are listed in Section 8 (starting on page 263) of the catalog.

### Branding

Example: Galaxy® by Continental ContiTech SAE J2064 Type C Class I 13/32" ID (10mm) 4826 - Size 8

Descriptive #/ Product #	SAP #	Hose Size ID		Hose OD		Max. Working Pressure		Min. Bend Radius		Min. Burst Pressure		Weight
		in.	mm	in.	mm	psi	MPa	in.	mm	psi	MPa	
G4867-14	20306586	3/4	19.0	1.13	28.6	350	2.4	6.3	160	1750	12.1	0.26

# Galaxy® SLE G4890

SAE J2064 | Air Conditioning



› Meets or exceeds the performance requirements of: SAE J2064, Type C Class 1

### Application

Recommended for R134a, R1234yf and most refrigerant blends and compressor lubricants in automotive and heavy-duty truck air conditioning systems where significant reduction in permeation and moisture ingress is desired.

### Inner Tube

Chloroprene

### Barrier

Nylon

### Reinforcement

Single-braid polyester

### Cover

Black Chlorobutyl (CIIR)

### Temperature Range

-40°F to 275°F (-40°C to 135°C)

### Fitting Reference

All fittings compatible with the G4890 hose family are listed in Section 8 (starting on page 276) of the catalog.

### Branding

Example: Galaxy® by Continental ContiTech SAE J2064 Type C Class I 5/16" ID (8mm) 4890 - Size 6

Descriptive #/ Product #	SAP #	Hose Size ID		Hose OD		Max. Working Pressure		Min. Bend Radius		Min. Burst Pressure		Weight
		in.	mm	in.	mm	psi	MPa	in.	mm	psi	MPa	
G4890-06	20306246	5/16	7.9	0.56	14.7	500	3.4	1.0	25	2000	13.8	0.09
G4890-08	20306247	13/32	10.3	0.69	17.3	500	3.4	1.5	38	2000	13.8	0.12
G4890-10	20306248	1/2	12.7	0.75	19.4	500	3.4	2.5	63	2000	13.8	0.13
G4890-12	20306249	5/8	15.9	0.94	23.6	350	2.4	4.0	104	1750	12.1	0.20

# MIL-DTL-13444H

TYPE I | Military Application



› Meets or exceeds the performance requirements of: MIL-DTL-13444H Type I

### Application

Fuel and oil lines in military vehicles and other military applications.

### Inner Tube

Nitrile

### Reinforcement

Single fabric braid

### Cover

Polychloroprene

### Temperature Range

-65°F to 250°F (-53.89°C to 121.1°C)

### Qualification

QPL-13444 Type I approved for bulk hose. QPL-13444 Type I approved for permanent UC fittings with UCF2 Ferrules on factory assemblies. Distributor-made assemblies must seek DSCC approval.

Descriptive #/ Product #	SAP #	Hose Size ID		Hose OD		Max. Working Pressure		Min. Bend Radius		Min. Burst Pressure		Weight
		in.	Military Dash Size	in.	mm	psi	MPa	in.	mm	psi	MPa	
MIL-H-13444-I-3	20472785	3/16	3	0.44	11.1	425	2.9	2.00	50.80	1700	11.7	.070
MIL-H-13444-I-4	20468052	1/4	4	0.50	12.7	300	2.0	2.25	57.15	1250	8.6	.090
MIL-H-13444-I-5	20470472	5/16	5	0.56	14.3	275	1.9	2.75	69.85	1100	7.6	.100
MIL-H-13444-I-6	20472786	3/8	6	0.63	15.9	250	1.7	3.00	76.20	1000	6.9	.110
MIL-H-13444-I-8	20485914	1/2	8	0.78	19.8	200	1.4	3.75	95.25	750	5.2	.170
MIL-H-13444-I-10	20490906	5/8	10	0.97	25.6	175	1.2	4.75	120.65	700	4.8	.220
MIL-H-13444-I-12	20493008	3/4	12	1.09	27.8	125	0.9	5.50	139.70	500	3.4	.260

## MIL-DTL-13444H

TYPE III | Military Application



### Application

Medium-pressure hydraulic oil and fuel lines. Used in military vehicles and other support equipment.

### Reinforcement

Textile braid and 1-wire steel braid

### Qualification

QPL-13444 Type III approved for bulk hose. QPL-13444 Type III approved for permanent UC fittings with UCF6 Ferrules on factory assemblies. Distributor-made assemblies must seek DSCC approval.

### Inner Tube

Nitrile

### Cover

Black impregnated textile braid

### Temperature Range

-55°F to 300°F (-48.33°C to 148.89°C)

› Meets or exceeds the performance requirements of: MIL-DTL-13444H Type III

Descriptive #/ Product #	SAP #	Hose Size ID		Hose OD		Max. Working Pressure		Min. Bend Radius		Min. Burst Pressure		Weight
		in.	Military Dash Size	in.	mm	psi	MPa	in.	mm	psi	MPa	
MIL-H-13444-III-4	20474735	3/16	4	0.49	12.5	1500	10.3	0.75	19.05	6000	41.4	0.29
MIL-H-13444-III-5	20479489	1/4	5	0.55	14.1	1500	10.3	1.00	25.40	6000	41.4	0.28
MIL-H-13444-III-6	20476712	5/16	6	0.62	15.7	1000	6.8	1.25	31.75	4000	27.5	0.39
MIL-H-13444-III-8	20477294	13/32	8	0.74	18.7	1000	6.8	1.75	44.45	4000	27.5	0.47
MIL-H-13444-III-10	20488137	1/2	10	0.83	21.1	875	6.0	2.25	31.75	3500	24.1	0.47
MIL-H-13444-III-12	20494896	5/8	12	0.96	24.3	750	5.1	2.75	69.85	3000	20.7	0.32
MIL-H-13444-III-16	20524468	7/8	16	1.21	30.6	375	2.6	3.50	88.90	1500	10.3	0.44
MIL-H-13444-III-20	20597709	1 1/8	20	1.49	37.8	300	2.0	4.50	114.3	1250	8.6	0.50

## MIL-DTL-13531

TYPE II, Class A | Military Application



### Application

Medium- and high-pressure hydraulic systems.

### Reinforcement

2 braids of high-tensile steel wire

### Qualification

QPL-13531 approved for bulk hose. QPL-13531 approved for permanent UC fittings with UCF2 Ferrules on factory hose assemblies. Distributor-made assemblies must seek DSCC approval.

### Inner Tube

Nitrile

### Cover

Black polychloroprene

### Temperature Range

-65°F to 200°F (-53.89°C to 93.33°C)

› Meets or exceeds the performance requirements of: MIL-DTL-13531 Type II, Class A

Descriptive #/ Product #	SAP #	Hose Size ID		Hose OD		Max. Working Pressure		Min. Bend Radius		Min. Burst Pressure		Weight
		in.	Military Dash Size	in.	mm	psi	MPa	in.	mm	psi	MPa	
M13531-B3A	20441525	3/16	3	0.63	15.9	5000	34.47	4.0	101.6	20000	137.9	0.26
M13531-B4A	20441526	1/4	4	0.69	17.5	5000	34.47	4.0	101.6	20000	137.9	0.31
M13531-B5A	20441527	5/16	5	0.75	19.1	4250	29.30	4.5	114.3	17000	117.2	0.33
M13531-B6A	20441528	3/8	6	0.84	21.4	4000	27.57	5.0	127.0	16000	110.3	0.41
M13531-B8A	20441529	1/2	8	0.97	24.6	3500	24.13	7.0	117.8	14000	96.5	0.50
M13531-B10A	20442170	5/8	10	1.09	27.8	2750	18.96	8.5	215.9	11000	75.8	0.59
M13531-B12A	20442171	3/4	12	1.25	31.8	2250	15.51	9.5	241.3	9000	62.1	0.72
M13531-B14A	20442172	7/8	14	1.38	34.9	2000	13.78	10.5	266.7	8000	55.2	0.81
M13531-B16A	20442173	1	16	1.56	39.7	2000	13.78	11.0	279.4	8000	55.2	1.01

# MIL-DTL-3992

TYPE I, Class 1 | Military Application



### Application

Low-pressure hose for flexible connections in air brake systems on automotive vehicles.

### Inner Tube

Nitrile

### Cover

Black polychloroprene

### Reinforcement

2 textile braids

### Temperature Range

-60°F to 200°F (-51°C to 93°C)

› Meets or exceeds the performance requirements of: MIL-DTL-39921

Descriptive #/ Product #	SAP #	Hose Size ID		Hose OD		Max. Working Pressure		Min. Bend Radius		Min. Burst Pressure		Weight
		in.	mm	in.	mm	psi	MPa	in.	mm	psi	MPa	
M3992-B0112	20024160	3/8	9.53	0.75	19.1	200	1.38	3.5	88.9	900	6.2	0.18
M3992-B0116	20568988	1/2	12.7	0.88	22.2	200	1.38	4.0	101.6	900	6.2	0.21

# MIL-DTL-8788

Hydraulic Hose | Military Application



### Application

High-pressure hydraulic systems requiring interoperability and compatibility with associated components and equipment.

### Inner Tube

Nitrile

### Cover

Black polychloroprene

### Reinforcement

2 braids of high-tensile steel wire

### Temperature Range

-65°F to 160°F (-54°C to 71°C)

› Meets or exceeds the performance requirements of: MIL-DTL-8788

Descriptive #/ Product #	SAP #	Hose Size ID		Hose OD		Max. Working Pressure		Min. Bend Radius		Min. Burst Pressure		Weight
		in.	mm	in.	mm	psi	MPa	in.	mm	psi	MPa	
M8788-4	20024593	0.22	5.6	0.625	15.88	3000	20.68	3.00	76.20	12000	82.8	0.27
M8788-5	20024596	0.28	7.1	0.703	17.86	3000	20.68	3.38	85.85	12000	82.8	0.32
M8788-6	20024600	0.34	8.7	0.766	19.46	3000	20.68	5.00	127.00	12000	82.8	0.37
M8788-8	20024604	0.44	11.1	0.859	21.82	3000	20.68	5.75	146.05	12000	82.8	0.44
M8788-10	20024613	0.56	14.3	1.031	26.19	3000	20.68	6.50	165.10	12000	82.8	0.57
M8788-12	20024616	0.69	17.5	1.219	30.96	3000	20.68	7.75	196.85	12000	82.8	0.76
M8788-16	20024619	0.88	22.2	1.500	38.10	3000	20.68	9.63	244.60	12000	82.8	1.32

## Hose Working Pressure Selection Guide

### Hose dash size and recommended working pressures

This table is to be used as a guide in the selection of hose by maximum working pressure. The recommended maximum working pressure should not be the only factor in hose selection. Final selection of the hose is further dependent on fluid and ambient temperatures, concentration of the fluid, and intermittent or continuous exposure.

Pressure Range	Family Part #	Hose Description	Dash Size							
			02	03	04	05	06	08	10	12
			Hose ID							
			1/8" (3.3 mm)	3/16" (4.8 mm)	1/4" (6.4 mm) R5, UT: 3/16" (4.8 mm)	5/16" (7.9 mm) R5, UT: 1/4" (6.4 mm)	3/8" (9.5 mm) R5: 5/16" (7.9 mm)	1/2" (12.7 mm) R5, UT, AC: 13/32" (10.3 mm)	5/8" (15.9 mm) R5, UT, AC: 1/2" (12.7 mm)	3/4" (19 mm) R5, UT, AC: 5/8" (15.9 mm)
Low Pressure	SR6	SAE 100R6/EN 854 R6		500	400	400	400	400	350	300
	HR6	SAE 100R6/EN 854 R6 (High Temp)			400	400	400	400	350	300
	HR4	SAE 100R4								300
	SR3	SAE 100R3/EN 854 R3			1250	1200	1125	1000		750
Low Pressure Push-On	IG	Insta-Grip™ 300 (Non-Conductive)			300	300	300	300	300	300
	IGHT	Insta-Grip™ HT 300 (High Temp)			300		300	300	300	300
	IGTC	Insta-Grip™ TC			300	300	300	300	300	300
	FXG	FLEXA-Grip™ Plus		400	400		400	400	400	400
Medium Pressure	SR1SN	SAE 100R1AT/1SN		3625	3260	3120	2615	2320	1890	1530
	Desert® DR1SN	SAE 100R1AT/1SN (High Temp)			3270		2615	2320	1890	1530
	SFS	SAE 100R1AT (Fire Suppression)			2750		2250	2000		1250
High Pressure	SR2SN	SAE 100R2AT/2SN		6200	5800		4800	4000	3630	3120
	Desert® DR2SN	SAE 100R2AT/2SN (High Temp)			5800		4800	4000	3630	3120
	XR16SC	SAE 100R16/EN 857 2SC			5800		5000	5000	4000	3500
	LR2SN	Arctic® SAE 100R2AT/2SN (Low Temp)			5000		4800	4000	3630	3120
	DR16SC	SAE 100R16/EN 857 2SC			5075		5000	5000		3500
	SR16SC	SAE 100R16/EN 857 2SC			5800		5000	5000	4000	3500
	ARC16SC	ARMORCOAT™ SAE 100R16/EN 857 2SC (Abrasion Cover)			5800		5000	5000	4000	3500
	XCP3	SAE 100R17 (Constant Pressure)			3045		3045	3045	3045	3045
	SCP3	SAE 100R17 (Constant Pressure)			3045		3045	3045	3045	3045
	ACP3	ARMORCOAT™ SAE 100R17 (Abrasion Cover)			3045		3045	3045		



# Hose Working Pressure Selection Guide

Continued

Pressure Range	Family Part #	Hose Description	Dash Size								
			14	16	20	24	32	40	48	56	64
			Hose ID								
			7/8" (22.2 mm) UT, AC:	1" (25.4 mm) R5, UT:	1 1/4" (31.8 mm) R5, UT:	1 1/2" (38.1 mm) R5, UT:	2" (50.8 mm) R5, UT:				
			3/4" (19 mm)	R5, UT: 7/8" (22.2 mm)	1 1/8" (28.6 mm)	R5: 1 3/8" (35 mm)	R5: 1 3/16" (46 mm)	2 1/2" (63.5 mm)	3" (76.2 mm)	3 1/2" (89 mm)	4" (101.6 mm)
Low Pressure	SR6	SAE 100R6/EN 854 R6									
	HR6	SAE 100R6/EN 854 R6 (High Temp)									
	HR4	SAE 100R4		250	200	150	100	62	56	45	35
	SR3	SAE 100R3/EN 854 R3		565	377				58		
Low Pressure Push-On	IG	Insta-Grip™ 300 (Non-Conductive)		300							
	IGHT	Insta-Grip™ HT 300 (High Temp)									
	IGTC	Insta-Grip™ TC									
	FXG	FLEXA-Grip™		400							
Medium Pressure	SR1SN	SAE 100R1AT/1SN		1280	920	730	580				
	DR1SN	SAE 100R1AT/1SN (High Temp)		1280	920	730	580				
	SFS	SAE 100R1AT (Fire Suppression)		1000							
High Pressure	SR2SN	SAE 100R2AT/2SN		2400	1820	1310	1160				
	Desert® DR2SN	SAE 100R2AT/2SN (High Temp)		2400							
	XR16SC	SAE 100R16/EN 857 2SC		2700							
	LR2SN	Arctic® SAE 100R2AT/2SN (Low Temp)		2400	1820		1160				
	DR16SC	SAE 100R16/EN 857 2SC		2700							
	SR16SC	SAE 100R16/EN 857 2SC		2700	1813						
	ARC16SC	ARMORCOAT™ SAE 100R16/EN 857 2SC (Abrasion Cover)		2700							
	XCP3	SAE 100R17 (Constant Pressure)		3045							
	SCP3	(Constant Pressure)		3045							
	ACP3	ARMORCOAT™ SAE 100R17 (Abrasion Cover)									

Fittings

Equipment & Accessories

Assemblies

Installation & Maintenance

Appendix

# Hose Working Pressure Selection Guide

Continued

Pressure Range	Family Part #	Hose Description	Dash Size							
			02	03	04	05	06	08	10	12
			Hose ID							
			1/8" (3.3 mm)	3/16" (4.8 mm)	1/4" (6.4 mm) R5, UT: 3/16" (4.8 mm)	5/16" (7.9 mm) R5, UT: 1/4" (6.4 mm)	3/8" (9.5 mm) R5: 5/16" (7.9 mm)	1/2" (12.7 mm) R5, UT, AC: 13/32" (10.3 mm)	5/8" (15.9 mm) R5, UT, AC: 1/2" (12.7 mm)	3/4" (19 mm) R5, UT, AC: 5/8" (15.9 mm)
Very High Pressure	XCP4	SAE 100R19/ISO 11237			4000		4000	4000	4000	4000
	SR12	SAE 100R12/EN 856 R12					4100	4100	4100	4100
	ARC12	ARMORCOAT™ SAE 100R12/EN 856 R12 (Abrasion Cover)					4100	4100	4100	4100
	SR13	SAE 100R13/EN 856 R13								5100
	ARC13	ARMORCOAT™ SAE 100R13/EN 856 R13 (Abrasion Cover)								5100
	SR15	SAE 100R15						6100		6100
	ARC15	ARMORCOAT™ SAE 100R15 (Abrasion Cover)						6100		6100
	S4SP	EN 856 4SP					6455	6020	5075	5510
	S4SH	EN 856 4SH								6090
Thermoplastic	SR7	SAE 100R7/EN 855 R7	2500	3000	3000	2500	2250	2000		1250
	TR7	SAE 100R7 (Twin-Line)		3000	3000	2500	2250	2000		
	NR7	SAE 100R7 (Non-Conductive)	2500	3000	2750	2500	2250	2250		1250
	BR7	SAE 100R7 (Twin-Line, Non-Conductive)			2750	2500	2250	2250		
	SR8	SAE 100R8/EN 855 R8		5000	5000		4000	3500		
	TR8	SAE 100R8 (Twin-Line)					4000	3500		
	NR8	SAE 100R8 (Non-Conductive)			5000		4000	3500		
	SR18	SAE 100R18			3000	3000	3000	3000		
Special Application	NSFX	SAFLEX® (Non-conductive)			2750		2250	2000		
	SHR	Prospector™ SHR (Slim-Hole Rotary)								
	BOP	Prospector™ BOP (Blow Out Preventor)					3000/5000	3000/5000		3000/5000
	SGUN	Grease Gun Hose		3000						
	SHJ	Jack Hose			10000		10000			
	Hot Oiler	Prospector (Hot Oiler)								

Fittings

Equipment & Accessories

Assemblies

Installation & Maintenance

Appendix

# Hose Working Pressure Selection Guide

Continued

Pressure Range	Family Part #	Hose Description	Dash Size								
			14	16	20	24	32	40	48	56	64
			Hose ID								
			7/8" (22.2 mm) UT, AC: 3/4" (19 mm)	1" (25.4 mm) R5, UT: 7/8" (22.2 mm)	1 1/4" (31.8 mm) R5, UT: 1 1/8" (28.6 mm)	1 1/2" (38.1 mm) R5: 1 3/8" (35 mm)	2" (50.8 mm) R5: 1 3/4" (46 mm)	2 1/2" (63.5 mm)	3" (76.2 mm)	3 1/2" (89 mm)	4" (101.6 mm)
Very High Pressure	SR12	SAE 100R12/EN 856 R12		4100	3050	2550	2550				
	ARC12	ARMORCOAT™ SAE 100R12/EN 856 R12 (Abrasion Cover)		4100	3050	2550	2550				
	SR13	SAE 100R13/EN 856 R13		5100	5100	5100	5100				
	ARC13	ARMORCOAT™ SAE 100R13/EN 856 R13 (Abrasion Cover)		5100	5100	5100	5100				
	SR15	SAE 100R15		6100	6100	6100					
	ARC15	ARMORCOAT™ SAE 100R15 (Abrasion Cover)		6100							
	S4SP	EN 856 4SP		4640							
	S4SH	EN 856 4SH		5510	5080	4205	3650				
Thermoplastic	SR7	SAE 100R7/EN 855 R7		1000							
	TR7	SAE 100R7 (Twin-Line)									
	NR7	SAE 100R7 (Non-Conductive)		1000							
	BR7	SAE 100R7 (Twin-Line, Non-Conductive)									
	SR8	SAE 100R8/EN 855 R8									
	TR8	SAE 100R8 (Twin-Line)									
	NR8	SAE 100R8 (Non-Conductive)									
	SR18	SAE 100R18									
Special Application	NSFX	SAFLEX® (Non-conductive)									
	SHR	Prospector™ SHR (Slim-Hole Rotary)		5100	5100	5100	5100/ 3650/ 3000		2400		
	BOP	Prospector™ BOP (Blow Out Preventor)		3000/ 5000	5000	5000	5000				
	SGUN	Grease Gun Hose									
	SHJ	Jack Hose									
	Hot Oiler	Prospector™ (Hot Oiler)				2500					

# Hose Working Pressure Selection Guide

Continued

Pressure Range	Family Part #	Hose Description	Dash Size							
			02	03	04	05	06	08	10	12
			Hose ID							
			1/8" (3.3 mm)	3/16" (4.8 mm)	1/4" (6.4 mm) R5, UT: 3/16" (4.8 mm)	5/16" (7.9 mm) R5, UT: 1/4" (6.4 mm)	3/8" (9.5 mm) R5: 5/16" (7.9 mm)	1/2" (12.7 mm) R5, UT, AC: 13/32" (10.3 mm)	5/8" (15.9 mm) R5, UT, AC: 1/2" (12.7 mm)	3/4" (19 mm) R5, UT, AC: 5/8" (15.9 mm)
Fleet Application	SR14A	SAE 100R14A		3000	3000	2500	2250	1500	1200	1100
	SR5	SAE 100R5			3000	3000	2250	2000	1750	1500
	DR5	Desert® SAE 100R5 (High Temp)			3000	3000	2250	2000	1750	1500
	SCX5	SAE 100R5 (Rubber Covered)				3000	2250	2000	1750	1500
	Desert® DUT	Universal Truck			2000	1500	1500	1250	1000	750
Air Conditioning	G4826	Air Conditioning SAE J2064 Type C Class II					500	500	500	350
	G4867	Air Conditioning SAE J2064 Type C Class II								
	G4890	Air Conditioning SAE J2064 Type C Class I					500	500	500	350
Military Application	MIL-H-13444-I	MIL-DTL-13444H Type I		425	300	275	250	200	175	125
	MIL-H-13444-III	MIL-DTL-13444H Type III			1500	1500	1000	1000	875	750
	M13531-BA	MIL-DTL-13531 Type II, Class A		5000	5000	4250	4000	3500	2750	2250
	MIL-3992	MIL-DTL-39921 Type I, Class 1					200		200	
	M8788	MIL-DTL-8788			3000	3000	3000	3000	3000	3000

Fittings

Equipment & Accessories

Assemblies

Installation & Maintenance

Appendix

# Hose Working Pressure Selection Guide

Continued

Pressure Range	Family Part #	Hose Description	Dash Size								
			14	16	20	24	32	40	48	56	64
			Hose ID								
			7/8" (22.2mm) UT, AC: 3/4" (19mm)	1" (25.4 mm) R5, UT: 7/8" (22.2 mm)	1¼" (31.8 mm) R5, UT: (28.6 mm)	1½" (38.1 mm) R5: 1½" (35 mm)	2" (50.8 mm) R5: 1¾" (46 mm)	2½" (63.5 mm)	3" (76.2 mm)	3½" (89 mm)	4" (101.6 mm)
Fleet Application	SR14A	SAE 100R14A		900							
	SR5	SAE 100R5		800	625	500	350				
	DR5	Desert® SAE 100R5 (High Temp)		800	625						
	SCX5	SAE 100R5 (Rubber Covered)		800	625						
	Desert® DUT	Universal Truck		400	300						
Air Conditioning	G4826	Air Conditioning SAE J2064 Type C Class II									
	G4867	Air Conditioning SAE J2064 Type C Class II	350								
	G4890	Air Conditioning SAE J2064 Type C Class I									
Military Application	MIL-H-13444-I	MIL-DTL-13444H Type I									
	MIL-H-13444 III	MIL-DTL-13444H Type III			375	300					
	M13531-BA	MIL-DTL-13531 Type II, Class A		2000	2000						
	MIL-3992	MIL-DTL-39921 Type I, Class 1									
	M8788	MIL-DTL-8788			3000						

Fittings

Equipment & Accessories

Assemblies

Installation & Maintenance

Appendix

# Hydraulic Hose Special Attributes

Fittings

Equipment & Accessories

Assemblies

Installation & Maintenance

Appendix

Family Part #	Hose Description	Meets Flame Resistance USMSHA Designation	Meets Higher DIN/EN Pressure	USCG Approved	ABS Approved	Higher Temp Hose	Low Temp Hose	Abrasion Cover Hose	Twin-Line Hose	Non-Conductive Hose	Fire Tested	SAE J1402/ DOT
SR1SN	SAE 100R1AT/1SN											
Desert® DR1SN	SAE 100R1AT/1SN			≤1	≤1							
SFS	SAE 100R1AT/1SN (Fire Suppression)											
SR2SN	SAE 100R2AT/2SN											
Arctic® LR2SN	SAE 100R2AT/2SN											
DR16SC	SAE 100R16-EN 8572SC											
Desert® DR2SN	SAE 100R2AT/2SN											
SR3	SAE 100R3/EN 854 R3											
HR4	SAE 100R4											
SR5	SAE 100R5											
Desert® DR5	SAE 100R5											
SCX5	SAE 100R5 Working Pressure (Rubber Covered)											
Desert® DUT	SAE J1402 A1 (Universal Truck)											
SR6	SAE 100R6/ EN 854 R6											
HR6	SAE 100R6/ EN 854 R6											
SR7	SAE 100R7/ EN 855 R7											
NR7	SAE 100R7 (Non-Conductive)											
NSFX	SAFLEX® (Non-Conductive)											
TR7	SAE 100R7 (Twin-Line)											
BR7	SAE 100R7 (Twin-Line, Non-Conductive)											
SR8	SAE 100R8/ EN 855 R8											
NR8	SAE 100R8 (Non-Conductive)											
TR8	SAE 100R8 (Twin-Line)											
S4SH	EN 856 4SH/ DIN 20023 4SH				Pending							
S4SP	EN 856 4SP/ DIN 20023 4SP				Pending							
XCP4	SAE 100R19/ ISO 11237			Pending	Pending							
SR12	SAE 100R12/ EN 856 R12				Pending							

USCG - Hose and hose assemblies meet requirements of SAE J1492. Hose fittings meet requirements of SAE J1475

# Hydraulic Hose Special Attributes

Continued

Family Part #	Hose Description	Meets Flame Resistance USMSHA Designation	Meets Higher DIN/EN Pressure	USCG Approved	ABS Approved	Higher Temp Hose	Low Temp Hose	Abrasion Cover Hose	Twin-Line Hose	Non-Conductive Hose	Fire Tested	SAE J1402/ DOT
ARMORCOAT™ ARC12	SAE 100R12/ EN 856 R12	█	█					█				
SR13	SAE 100R13/ EN 856 R13	█	█	█	Pending							
ARMORCOAT™ ARC13	SAE 100R13/ EN 856 R13	█	█					█				
SR14A	SAE 100R14A					█	█					
SR15	SAE 100R15	█		█	Pending							
ARMORCOAT™ ARC15	SAE 100R15	█						█				
SR16SC	SAE 100R16/ 857 2SC	█	█	█								
Desert® XR16SC	SAE 100R16/ 857 2SC	█	█	█				█				
ARMORCOAT™ ARC16SC	SAE 100R16/ 857 2SC	█	█					█				
SCP3	SAE 100R17	█		█								
ARMORCOAT™ ACP3	SAE 100R17	█						█				
XCP3	SAE 100R17	█		█				█				
SR18	SAE 100R18						█					
SHR	Prospector™ SHR (Slim-Hole Rotary)	█										
BOP	Prospector™ BOP (Blow-Out Preventor)										█	
SGUN	Grease Gun Hose	█										
SHJ	Jack Hose	█										
IG	Insta-Grip™ 300 (Push-On)	█								█		
IGHT	Insta-Grip™ HT 300 (Push-On, High Temp)					█						
IGTC	Insta-Grip™ TC (Push-On, Textile Cover)											
FXG	FLEXA-Grip™ (Push-On)	█						█		█		
MIL-H-13444-I	MIL-DTL-13444H Type I (Military)						█					
MIL-H-13444-III	MIL-DTL-13444H Type III (Military)					█	█					
M13531-BA	MIL-DTL-13531 Type II, Class A (Military)						█					
MIL-3992	MIL-DTL-39921 Type I, Class 1 (Military)						█					
M8788	MIL-DTL-8788 (Military)						█					

Fittings

Equipment & Accessories

Assemblies

Installation & Maintenance

Appendix

# Hose Temperature Limits

Fittings

Equipment & Accessories

Assemblies

Installation & Maintenance

Appendix

- A** SR14A (SAE 100R14A)\*
- Desert® DR5 (SAE 100R5 DOT FMVSS 106 AII)\*\*
- Desert® DUT (Universal Truck)
- B** IGHT (Insta-Grip™ HT 300)
- Desert® DR1SN (SAE 100R1AT/1SN)
- Desert® DR2SN (SAE 100R2AT/2SN)
- Desert® DR16SC (SAE 100R16/EN 857 2SC)

- C** HR4 (SAE 100R4)
- HR6 (SAE 100R6/EN 854 R6)

- D** SR12 (SAE 100R12/EN 856 R12)
- ARC12 (ARMORCOAT™ SAE 100R12/EN 856 R12)
- SR13 (SAE 100R13/EN 856 R13)
- ARC13 (ARMORCOAT™ SAE 100R13/EN 856 R13)
- SR15 (SAE 100R15)
- ARC15 (ARMORCOAT™ SAE 100R15)
- SHR (Prospector™ Slim-Hole Rotary Hose)
- Prospector™ BOP 5000

- E** LR2SN (SAE 100R2AT/2SN)

- F** SFS (SAE 100R1AT Fire Suppression)
- SR1SN (SAE 100R1AT/1SN)
- SR2SN (SAE 100R2AT/2SN)
- SR3 (SAE 100R3/EN 854 R3)
- SR5 (SAE 100R5 DOT FMVSS 106 AII)
- SR6 (SAE 100R6/EN 854 R6)
- NSFX (SAFLEX® Non-Conductive)
- S4SH (EN 856 4SH/DIN 20023 4SH)
- S4SP (EN 856 4SP/DIN 20023 4SP)
- SR16SC (SAE 100R16/EN 857 2SC)
- XR16SC (SAE/EN857 2SC)
- ARC16SC (ARMORCOAT™ SAE 100R16/EN 857 2SC)
- SCP3 (SAE 100R17)
- XCP3 (SAE 100R17 Constant Pressure)
- ACP3 (ARMORCOAT™ SAE 100R17)
- XCP4 (SAE 100R19/ISO11237)
- SGUN (Grease Gun Hose)
- SHJ (Jack Hose)
- Prospector™ BOP 3000
- SCX5

- G** SR7 (SAE 100R7/EN 855 R7)
- TR7 (SAE 100R7 Twin-Line)
- SR8 (SAE 100R8/EN 858 R8)
- TR8 (SAE 100R8 Twin-Line)
- NR8 (SAE 100R8 Non-Conductive)
- IGTC (Insta-Grip™ TC)
- FXG (FLEXA-Grip™)

- H** NR7 (SAE 100R7 Non-Conductive)
- BR7 (SAE 100R7 Twin-Line, Non-Conductive)
- SR18 (SAE 100R18)

- I** IG (Insta-Grip™ 300)
- J** MIL-8788
- K** MIL-13531
- K** MIL-3992
- M** MIL-13444-I
- N** MIL-13444-III

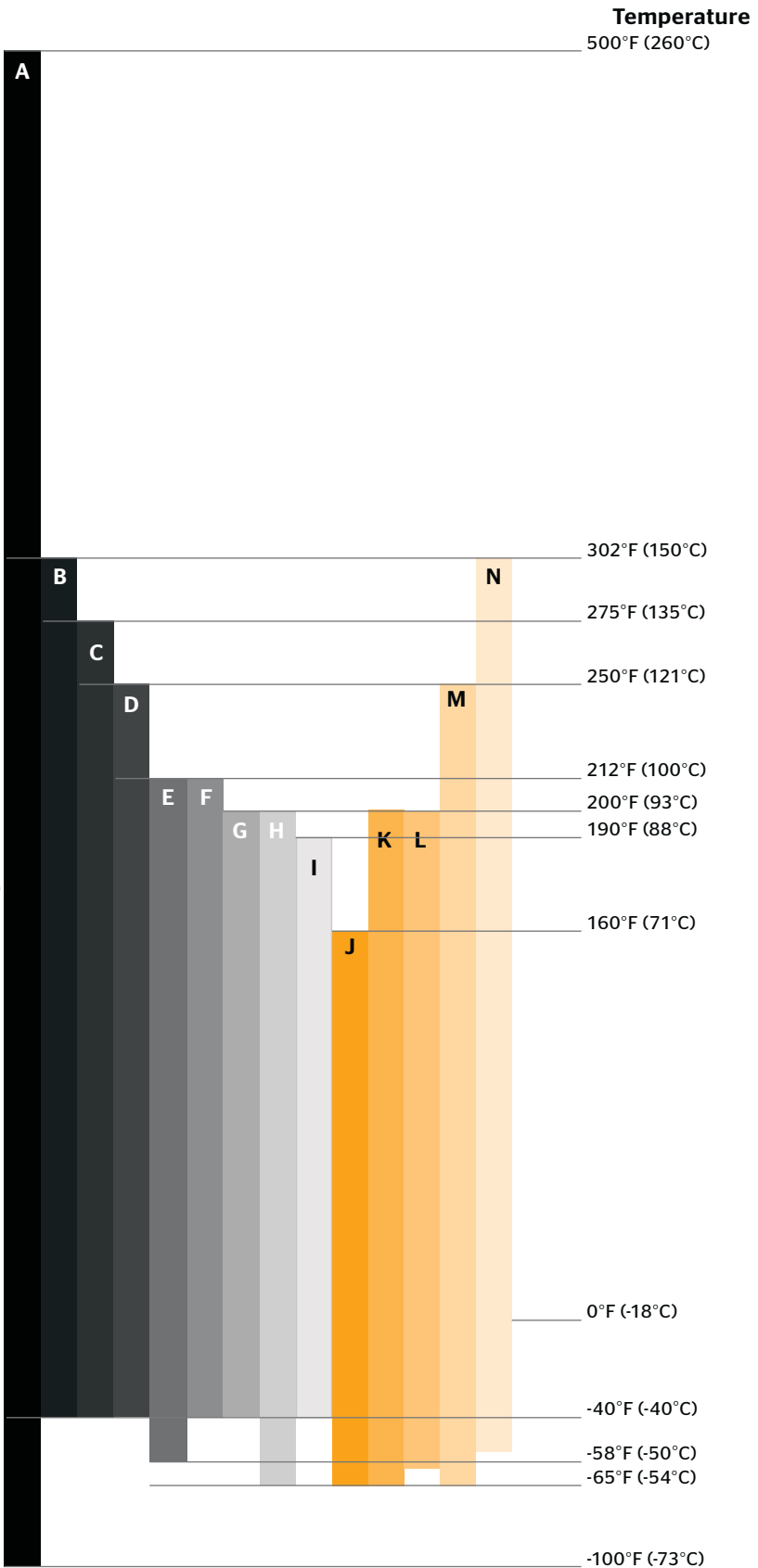

\*Intermittent Service

\*\*Hot Oil/Hydraulic Application



## Hose Accessories

### Protective Sleeving



#### Application

Extends hose life by protecting hose covers from abrasion typically found in industries such as agricultural, logging, construction and mining. Protective sleeving can also be useful in bundling hose assemblies, making it easier to handle multiple hoses.

#### Features

- › Abrasion resistant
- › MSHA approved
- › Good resistance to sun, atmospheric agents and aging

#### Temperature Range

-40°F to 340°F (-40°C to 171.1°C)

#### Material

Polyamide 6 (nylon)

#### Color

Black

#### Available Lengths

Continuous 100' rolls

Descriptive #	Product #	SAP #	ID	Flat Width	Weight
			in.	in.	lbs./ft.
GTEXS20	60200-0020	20243598	0.79	1.34	.02
GTEXS25	60200-0025	20243599	0.98	1.65	.03
GTEXS27	60200-0027	20243600	1.06	1.77	.03
GTEXS31	60200-0031	20243601	1.22	2.05	.04
GTEXS36	60200-0036	20243602	1.42	2.24	.04
GTEXS40	60200-0040	20243603	1.57	2.60	.05
GTEXS44	60200-0044	20243604	1.73	2.83	.06
GTEXS55	60200-0055	20243605	2.17	3.50	.07

## Hose Accessories

### Protective Wrap



#### Application

Extends hose life by offering resistance to kinking and cover abrasion. The protective wrap may also be used for the bundling of hose lines for easier handling.

#### Features

- › Can be installed without disconnecting hose
- › Can be overlapped for greater protection
- › Lightweight

#### Temperature Range

-30°F to 185°F (-34°C to 85°C)

#### Material

Cellulose acetate (thermoplastic)

#### Color

Black

#### Available Lengths

Continuous 66' rolls

Descriptive #	Product #	SAP #	ID	Flat Width	Weight
			in.	in.	lbs./ft.
HWRAP-12	60210-0012	20243592	0.50	.07	.05
HWRAP-16	60210-0016	20243593	0.63	.07	.06
HWRAP-19	60210-0019	20243594	0.75	.09	.08
HWRAP-25	60210-0025	20243595	1.00	.09	.12
HWRAP-35	60210-0035	20243596	1.38	.09	.17
HWRAP-47	60210-0047	20243597	1.85	.15	.28

\*Extruded spiral will have +/- 4% variation in thickness and weight.

## Hose Accessories

### Hose Routing Clamps



#### Application

Used for support for long hose lengths. Also aids proper hose routing where abrasion or heat exists.

#### Material

Steel with 1/32" thick black vinyl cushion

Descriptive #	Product #	SAP #	Clamping Diameter		Bolt Hole	
			in.		in.	
HRC-0413	60300-0413	20539632	3/16		1/4	
HRC-0509	60300-0509	20539633	1/4		9/32	
HRC-0709	60300-0709	20431807	3/8		9/32	
HRC-0809	60300-0809	20431808	7/16		9/32	
HRC-0913	60300-0913	20431809	1/2		13/32	
HRC-1013	60300-1013	20431810	9/16		13/32	
HRC-1113	60300-1113	20431811	5/8		13/32	
HRC-1213	60300-1213	20431812	11/16		13/32	
HRC-1313	60300-1313	20431813	3/4		13/32	
HRC-1413	60300-1413	20431814	13/16		13/32	
HRC-1513	60300-1513	20431815	7/8		13/32	
HRC-1613	60300-1613	20431816	15/16		13/32	
HRC-1713	60300-1713	20431817	1		13/32	
HRC-1813	60300-1813	20431818	1 1/16		13/32	
HRC-1913	60300-1913	20431819	1 1/8		13/32	
HRC-2017	60300-2017	20431820	1 3/16		17/32	
HRC-2117	60300-2117	20431821	1 1/4		17/32	
HRC-2317	60300-2317	20431822	1 3/8		17/32	
HRC-2517	60300-2517	20431823	1 1/2		17/32	
HRC-2617	60300-2617	20431824	1 9/16		17/32	
HRC-2917	60300-2917	20431825	1 3/4		17/32	
HRC-3117	60300-3117	20431826	1 7/8		17/32	
HRC-3217	60300-3217	20431827	1 15/16		17/32	
HRC-3317	60300-3317	20431828	2		17/32	
HRC-3417	60300-3417	20431829	2 5/32		17/32	
HRC-3817	60300-3817	20431830	2 21/32		17/32	



# Fittings

# Hydraulic Fitting Nomenclature

Example: **B2 - JCFX45 - 0608**

Fitting Family	Thread Description	Hose Dash Size	Thread Dash Size
First 2 characters	Next 2-7 characters	Next 2 characters	Last 2 characters
<b>B2</b> S4 S6 Ultra-Crimp™ 1-piece fitting SG <hr/> T7 Thermoplastic 1-piece fitting T8 <hr/> FG = Field-Grip™ 1-piece reattachable fitting UT = DUT Hose 1-piece reattachable fitting <hr/> UC Uni-Crimp™ Stem (2-piece fitting) <hr/> DG Dual-Grip™ Stem (2-piece internal and external skive fitting) <hr/> PB = Push-On Brass (1-piece fitting) SF = SAFLEX® (1-piece fitting) GG = Grease Gun (1-piece fitting) AC = Air Conditioning (1-piece crimp fitting) GC = Cool Clip® (air conditioning clip fitting)	Refer to the next page for detailed information.  For AC and GC fittings, see Fittings Section 9.	<b>All hoses except SAE 100R5, SCX5, DUT and Galaxy Hose</b> 02 = 1/8" (3.2 mm) 03 = 3/16" (4.8 mm) 04 = 1/4" (6.4 mm) 05 = 5/16" (7.9 mm) <b>06 = 3/8" (9.5 mm)</b> 08 = 1/2" (12.7 mm) 10 = 5/8" (15.9 mm) 12 = 3/4" (19 mm) 16 = 1" (25.4 mm) 20 = 1 1/4" (31.8 mm) 24 = 1 1/2" (38.1 mm) 32 = 2" (50.8 mm) 40 = 2 1/2" (63.5 mm)  <b>SAE 100R5, DUT and Galaxy® Hose</b> 04 = 3/16" (4.8 mm) 05 = 1/4" (6.4 mm) 06 = 5/16" (7.9 mm) 08 = 13/32" (10.3 mm) 10 = 1/2" (12.7 mm) 12 = 5/8" (15.9 mm) 14 = 3/4" (19.1 mm) 16 = 7/8" (22.2 mm) 20 = 1 1/8" (28.6 mm) 24 = 1 3/8" (35 mm) 32 = 1 13/16" (46 mm)	02 03 04 05 06 <b>08</b> 10 12 14 15 16 18 20 22 24 26 28 30 32 33 36 40 42 45 52

See "Thread Reference Chart" on pages 299-300 for crossing over dash size to thread sizes.

## Warning - Selection of Fitting

Selection of the proper fittings for the application is essential to the proper operation and safe use of the hose and related equipment. Inadequate attention to the selection of the hose fitting for the application can result in hose leakage, bursting or other failures, which can cause serious bodily injury or property damage from spraying fluids or flying projectiles. Some of the factors involved in the selection of the proper hose ends are:

- › Fluid Compatibility
- › Pressure
- › Temperature
- › Installation Design
- › Hose Size
- › Corrosion Requirements

If there are any questions as to what fitting should be used, Continental ContiTech recommends that you consult the Continental ContiTech Hydraulics Application Group for assistance.

## Proper Assembly of Continental ContiTech Perma-Crimp™ Hose and Fittings

Continental ContiTech Perma-Crimp™ hose, fittings and crimping equipment work together to provide an efficient and reliable hose connection. Continental ContiTech hose and fittings are part of an engineered system and are to be assembled in accordance with Continental ContiTech specifications. Using non-Continental ContiTech components may produce an assembly that does not meet rated performance. Continental ContiTech DOES NOT WARRANT, EXPRESSLY OR BY IMPLICATION, HOSE ASSEMBLIES THAT DO NOT INCORPORATE Continental ContiTech PERMA-CRIMP™ HOSE AND FITTINGS, OR ARE NOT CRIMPED in ACCORDANCE WITH Continental ContiTech's PROCESS SPECIFICATIONS. Buyers may elect to attach additional or non-standard parts or equipment, or to use different manufacturing specifications, as necessary to meet the requirements of the buyer or customer's application. In such cases, the buyer has sole responsibility to qualify the hose for these applications as necessary to ensure performance capability.

For guidance in the assembly of Continental ContiTech Perma-Crimp™ hose and couplings, please refer to the Continental ContiTech Crimp Specifications Manual. Information in this catalog is believed to be accurate, but is not warranted, and is subject to change without prior notice. For the most current available product information, check [www.contitech.us](http://www.contitech.us).

**Hydraulic Fitting Nomenclature**

Thread	Thread Description	Gender	Swivel	Elbow
JC FX		Female	Swivel	
JC FX45		Female	Swivel	45° Elbow
JC FX90		Female	Swivel	90° Elbow
JC FX90L	JIC 37° Flare (SAE J514)	Female	Swivel	90° Elbow (Long Drop-Tube)
JC FX90S		Female	Swivel	90° Elbow (Short Drop-Tube)
JC M		Male		
SF FX		Female	Swivel	
SF FX45		Female	Swivel	45° Elbow
SF FX90		Female	Swivel	90° Elbow
SF FX90L	SAE 45° J512 Flare	Female	Swivel	90° Elbow (Long Drop-Tube)
SF FX90S		Female	Swivel	90° Elbow (Short Drop-Tube)
SF M		Male		
SI F		Female		
SI M		Male		
SI MX	SAE 45° Inverted Flare	Male	Swivel	
SI MX45		Male	Swivel	45° Elbow
SI MX90		Male	Swivel	90° Elbow
NP F		Female		
NP FX		Female	Swivel	
NP M	NPTF	Male		
NP M90		Male		90° Elbow
NP MX		Male	Swivel	
NP MX90B		Male	Swivel	90° Elbow (Block)
NP MAPI	NPTF - Oil Field Connection	Male		
HM	Hose Mender			
NS FX	NPSM	Female	Swivel	
FT M	SAE J514 Flareless Tube Fittings	Male		
GT F	Grease Tap	Female		
SP	Standpipe			
SP 45				45° Elbow

**Hydraulic Fitting Nomenclature**

Thread	Thread Description	Gender	Swivel	Elbow
OF FX		Female	Swivel	
OF FX45		Female	Swivel	45° Elbow
OF FX90		Female	Swivel	90° Elbow
OF FX90L	O-Ring Face Seal (SAE J1453 ORS/ORFS)	Female	Swivel	90° Elbow (Long Drop-Tube)
OF FX90S		Female	Swivel	90° Elbow (Short Drop-Tube)
OF M		Male		
OB M	O-Ring Boss Straight	Male		
OB MX	Thread (SAE J514)	Male	Swivel	
OB MX90B		Male	Swivel	90° Elbow (Black)
FL				
FL 22				22.5° Elbow
FL 30				30° Elbow
FL 45	Code 61 Flange (SAE J518)			45° Elbow
FL 60				60° Elbow
FL 67				67° Elbow
FL 90				90° Elbow
FL 110				110° Elbow
FL 135				135° Elbow
FL 90EOC	Engine Oil Connection			90° Elbow
FH				
FH 22				22.5° Elbow
FH 30	Code 62 Flange (SAE J518)			30° Elbow
FH 45				45° Elbow
FH 60				60° Elbow
FH 67				67° Elbow
FH 90				90° Elbow

Hydraulic Fitting Nomenclature (Continued on next page)

## Hydraulic Fitting Nomenclature (Continued)

Thread	Thread Description	Gender	Swivel	Elbow
CF				
CF 22				22.5° Elbow
CF 30				30° Elbow
CF 45	Caterpillar® Flange			45° Elbow
CF 60				60° Elbow
CF 67				67° Elbow
CF 90				90° Elbow
KF				
KF 45	Komatsu® Flange			45° Elbow
KF 90				90° Elbow
BP FX		Female	Swivel	
BP FX45	BSP (British Standard Pipe Parallel)	Female	Swivel	45° Elbow
BP FX90		Female	Swivel	90° Elbow
BP M		Male		
BT M	BSPT (British Standard Pipe Tapered)	Male		
BF FX	BSP Flat Seat (British Standard Pipe)	Female	Swivel	
DL FX		Female	Swivel	
DL FX45	DIN 24° Light	Female	Swivel	45° Elbow
DL FX90		Female	Swivel	90° Elbow
DL M		Male		
DH FX		Female	Swivel	
DH FX45	DIN 24° Heavy	Female	Swivel	45° Elbow
DH FX90		Female	Swivel	90° Elbow
DH M		Male		
DN FX45	DIN 60°	Female	Swivel	45° Elbow
DN FX90		Female	Swivel	90° Elbow
KM FX		Female	Swivel	
KM FX45	Japanese Komatsu® 30° Flare with Metric Threads	Female	Swivel	45° Elbow
KM FX90		Female	Swivel	90° Elbow
JS FX	JIS 30° (Parallel Pipe Threads)	Female	Swivel	
PTT FX	PTT 30° (for DUT Hose)	Female	Swivel	

## Hydraulic Ferrule Nomenclature

Example: **UCF3 - 08**

### Ferrule Family

First 4 characters of Part Number

UCF1  
UCF2  
**UCF3**  
UCF4  
UCF5  
UCF6  
UCF7  
UCF8  
UCF9  
UCF10  
UCF11

DGF1 Dual-Grip™ Ferrules,  
DGF2 to be used only with  
Dual-Grip™ Stems.

### Thread Dash Size

Last 2 characters of Part Number

03 = 3/16" (4.8 mm)  
04 = 1/4" (6.4 mm)  
05 = 5/16" (7.9 mm)  
06 = 3/8" (9.5 mm)  
**08 = 1/2" (12.7 mm)**  
10 = 5/8" (15.9 mm)  
12 = 3/4" (19 mm)  
16 = 1" (25.4 mm)  
20 = 1 1/4" (31.8 mm)  
24 = 1 1/2" (38.1 mm)  
32 = 2" (50.8 mm)  
40 = 2 1/2" (63.5 mm)

# Perma-Crimp™ Fitting Selection

## Using the Quick-Find™ Fitting Tables

Continental ContiTech Brand Quick-Find™ hydraulic hose and fitting catalog makes Perma-Crimp™ fitting selection very easy with a 5-step process.

### Step 1 - Choose the Hose Type

The first step in choosing the correct fitting is selecting the hose type. The fitting catalog and product line are broken up into 11 sections. The 11 sections are based on hose type.

#### Hose Family

Section 1	Section 2	Section 3	Section 4	Section 5	Section 6	Section 6A	Section 7	Section 8	Section 9
SR1SN	SR7	SR12	SR13	SR3	SR5	DUT	NSFX	G4826	Ferrules
DR1SN	TR7	ARC12	ARC13	HR4	DR5		SHR	G4867	
SFS	NR7		SR15	SR6	SCX5		Hot Oiler	G4890	
SR2SN	BR7		ARC15	HR6			SGUN		
DR2SN	SR8		S4SP	SR14A			SHJ		
LR2SN	TR8		S4SH				IG		
SR16SC	NR8						IGHT		
ARC16SC	SR18						IGTC		
DR16SC							FXG		
XR16SC									
SCP3									
ACP3									
XCP3									
XCP4									

### Step 2 - Choose the Fitting Description

Once the hose type has been identified, go to the correct section (Sections 1 to 9) and view the available fittings for that particular hose. Within the content of each section there is a table for each fitting. There is a Fitting Description at the top of each table which consists of the following elements:

#### Fitting Description Example

<b>JIC 37° Flare (SAE J514)</b>	<b>Female</b>	<b>45° Elbow</b>	<b>Swivel</b>
Thread Description	Gender	Elbow	Swivel or Non-swivel

Reference Thread Descriptions under Fitting Nomenclature at the beginning of this section. The other attributes of the Fitting Description, including Gender, Elbow and Swivel/Non-swivel, will be found in the fitting table.

### Step 3 - Choose Hose ID and Thread Size

Choose the correct fitting selected in Step 2 based on the Hose ID and Thread Size. In some cases, a fitting may be available in several thread sizes. As an example, a JIC 37° Flare (SAE J514) Female Swivel is available for a Hose ID of 3/8" and thread sizes 9/16-18 and 3/4-16.

### Step 4 - Determine Availability for Hose Type

With the desired fitting identified by Hose ID and Thread Size in Step 3, confirm the fitting is compatible for a particular Hose Type by reading to the right of the product table. A "Y" indicates the fitting is an Ultra-Crimp™ 1-piece fitting and compatible with the hose. A part number would indicate the fitting is a 2-piece fitting, either Uni-Crimp™ or Dual-Grip™ requiring a ferrule. The ferrule part number is required to make an assembly. A blank in the compatibility chart would indicate a fitting is not compatible with a particular hose.

### Step 5 - Note the Part Number

The fitting part number can now be noted. The part number is found on the left side of the chart. If a ferrule is required, that part number is found on the right side of the chart under hose compatibility (Step 4).

## Explanation of Fitting Part Number, Dimensions and Attributes

### Explanation of Part Number

The Continental ContiTech Perma-Crimp™ fitting can be described through its functional part number.

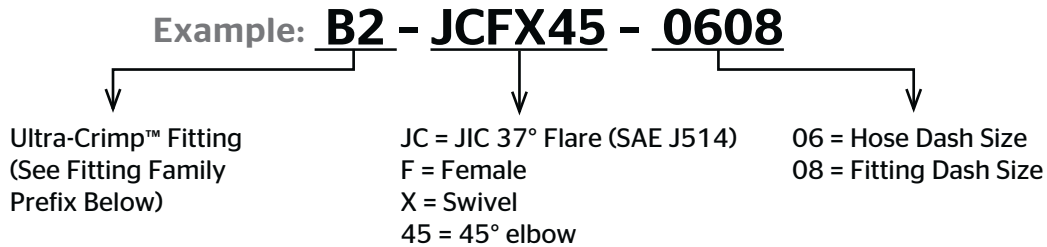

The following prefix will be used in the fitting part number to indicate the Fitting Family:

Fitting Family Prefix	ID
B2, S4, S6, SG	Ultra-Crimp™ 1-piece fitting
T7, T8	1-piece fitting for thermoplastic hose
FG	Field-Grip™ 1-piece reattachable fitting
UT	DUT Hose 1-piece reattachable fitting
UC	Uni-Crimp™ Stem (2-piece fitting)
DG	Dual-Grip™ Stem (2-piece internal and external skive fitting)
PB	Push-On Brass (1-piece fitting)
SF	SAFLEX® (1-piece fitting)
GG	Grease Gun (1-piece fitting)
AC	Air Conditioning (1-piece crimp fitting)
GC	Cool Clip® (air conditioning clip fitting)

For the additional breakdown of part number attributes, see Fitting Nomenclature at the beginning of this section.

### Fitting Dimensions and Attributes

Within the product tables, you will find the fitting dimensions or attributes.

**Hose ID** - The compatible hose ID.

**Tube ID** - The tube's outside diameter.

**Thread Size** - The thread size or sizes available for a particular fitting dash size.

**Hex Size** - The wrench size for one or both nuts on the fitting.

**Drop** - The drop or "D" dimension describes the length of the elbow.

**Cut-Off** - The "C" dimension is the amount of hose to be cut for a correct assembly length.

**Length** - The "L" dimension is the overall length of the fitting.

Tables will also indicate whether the fitting is a skive or non-skive type, or whether the fitting is an Ultra-Crimp™, indicated with a "Y" and the correct hose compatibility. In some cases, the fitting might be a Ultra-Crimp™, or two-piece fitting, requiring a ferrule. The ferrule will be denoted for each type of hose applicable.

Continental ContiTech Brand Quick-Find™ catalog is easy to use, with 5 steps in selecting a Perma-Crimp™ fitting. Knowing the hose type and thread style will lead you to the desired part number.



# How to Use the Fitting Tables

This section lists ALL fittings that are compatible with the following hoses:

Hose Family	Hose Description
SFS	Fire Suppression
SR1SN	SAE 100R1AT/1SN
DR1SN	SAE 100R1AT/1SN (Desert®)
SCP3	Constant Pressure 3000 SAE 100R17
ACP3	SAE 100R17 (Armorcoat)
XCP3	Constant Pressure 3000 SAE 100R17, Extended Life
XCP4	SAE 100R19 /ISO 11237 (Extended Life)
SR2SN	SAE 100R2AT/2SN
DR2SN	SAE 100R2AT/2SN (Desert®)
LR2SN	SAE 100R2AT/2SN (Low Temp)
SR16SC	SAE 100R16/EN 857 2SC
DR16SC	SAE 100R16/EN 857 2SC (Desert®)
XR16SC	SAE 100R16/EN 857 2SC (Extended Life)
ARC16SC	SAE 100R16/EN 857 2SC (Abrasion Cover)

## Fitting Description

Fitting Type

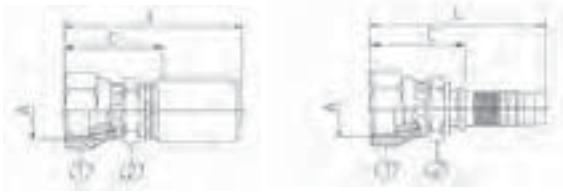

S=Skive  
NS=Non-Skive  
DG=Dual-Grip™

Descriptive #	Product #	SAP #	Hose Size ID		Thread Size (A)		Hex-1 Wrench Size		Hex-2 Wrench Size		Cut-Off (C)		Length (L)		Skive Type	SR1SN, DR1SN, SFS	SR2SN, DR2SN, LR2SN	SR16SC, XR16SC, ARC16SC, DR16SC	SCP3, XCP3, ACP3
			in.	mm	in.	mm	in.	mm	in.	mm	in.	mm	in.	mm		Y	Y	Y	Y
Ultra-Crimp, PN1	36400-0304	20557173	3/16	4.8	7/16-20	9/16	14	1/2	12	0.71	18.1	1.93	49.0	S	UCF1-03	UCF2-03	Y	Y	
Ultra-Crimp, PN2	14400-0403	20289599	1/4	6.4	3/8-24	9/16	14	1/2	12	0.78	19.8	2.05	52.0	NS	Y	Y	Y	Y	
Uni-Crimp, PN3	14400-0404	20293262	1/4	6.4	7/16-20	5/8	16	9/16	14	0.77	19.6	2.09	53.1	NS	Uni-Crimp Ferrule PN	Y	Y	Y	

Choose fittings carefully, considering the working pressure of both hose and fitting. The maximum working pressure of the hose assembly is the lesser of the rated working pressure of the hose and the fitting. See page 327 for working pressure.

A **Part Number (Ferrule)** in the hose compatibility columns indicates that the fitting is a **Uni-Crimp™** style. The fitting, along with the ferrule shown, work together as a unit for that particular hose.

A **“Y”** in the hose compatibility columns indicates that the fitting is an **Ultra-Crimp™** style fitting and that it works for that particular hose.

A **blank space** in the hose compatibility columns indicates that the fitting **DOES NOT** work for that particular hose.

# JIC 37° Flare (SAE J514)

Female | Swivel

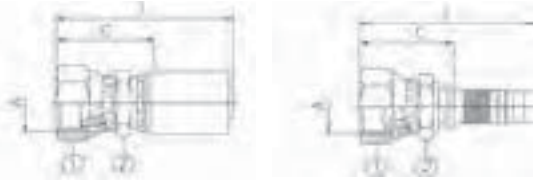

S=Skive  
NS=Non-Skive  
DG=Dual-Grip™

Descriptive #	Product #	SAP #	Hose Size ID		Thread Size (A)		Hex-1 Wrench Size		Hex-2 Wrench Size		Cut-Off (C)		Length (L)	Skive Type	SR15N, DR15N, SFS	SR25N, DR25N, LR25N	SR16SC, XR16SC, ARC16SC, DR16SC	SCP3, XCP3, ACP3	XCP4	
			in.	mm	in.	mm	in.	mm	in.	mm	in.	mm								in.
UCH-JCFX-0304		20530659	3/16	4.8	7/16-20	9/16	14	1/2	12	1.07	27.2	1.94	49.4	NS	UCF6-03	UCF6-03				
B2-JCFX-0403	14400-0403	20293242	1/4	6.4	3/8-24	9/16	14	1/2	12	1.11	28.1	2.09	53.0	NS	Y	Y	Y	Y	Y	
B2-JCFX-0404	14400-0404	20242031	1/4	6.4	7/16-20	5/8	16	9/16	14	1.17	29.6	2.15	54.5	NS	Y	Y	Y	Y	Y	
B2-JCFX-0404S	14400-0404S	20286835	1/4	6.4	7/16-20	5/8	16	9/16	14	1.17	29.6	2.15	54.5	NS	Y	Y	Y	Y	Y	
B2-JCFX-0405	14400-0405	20242032	1/4	6.4	1/2-20	11/16	17	9/16	14	1.24	31.4	2.22	56.3	NS	Y	Y	Y	Y	Y	
B2-JCFX-0406	14400-0406	20242029	1/4	6.4	9/16-18	3/4	19	9/16	14	1.23	31.2	2.21	56.1	NS	Y	Y	Y	Y	Y	
B2-JCFX-0406S	14400-0406S	20286836	1/4	6.4	9/16-18	3/4	19	9/16	14	1.23	31.2	2.21	56.1	NS	Y	Y	Y	Y	Y	
B2-JCFX-0505	14400-0505	20242038	5/16	7.9	1/2-20	11/16	17	9/16	14	1.24	31.4	2.22	56.3	NS	Y					
B2-JCFX-0506	14400-0506	20242037	5/16	7.9	9/16-18	3/4	19	9/16	14	1.23	31.2	2.21	56.1	NS	Y					
B2-JCFX-0604	14400-0604	20265707	3/8	9.5	7/16-20	5/8	16	11/16	17	1.16	29.4	2.21	56.0	NS	Y	Y	Y	Y	Y	
B2-JCFX-0606	14400-0606	20242041	3/8	9.5	9/16-18	3/4	19	11/16	17	1.22	31.1	2.27	57.7	NS	Y	Y	Y	Y	Y	
B2-JCFX-0606S	14400-0606S	20286837	3/8	9.5	9/16-18	3/4	19	11/16	17	1.22	31.1	2.27	57.7	NS	Y	Y	Y	Y	Y	
B2-JCFX-0608	14400-0608	20242050	3/8	9.5	3/4-16	1	25	3/4	19	1.37	34.9	2.42	61.5	NS	Y	Y	Y	Y	Y	
B2-JCFX-0608S	14400-0608S	20286838	3/8	9.5	3/4-16	1	25	3/4	19	1.37	34.9	2.42	61.5	NS	Y	Y	Y	Y	Y	
B2-JCFX-0610	14400-0610	20242043	3/8	9.5	7/8-14	1 1/16	27	7/8	22	1.53	38.8	2.58	65.5	NS	Y	Y	Y	Y	Y	
B2-JCFX-0612	14400-0612	20293243	3/8	9.5	1 1/16-12	1 1/4	32	1	25	1.64	41.6	2.69	68.3	NS	Y	Y	Y	Y	Y	
B2-JCFX-0806	14400-0806	20242034	1/2	12.7	9/16-18	3/4	19	3/4	19	1.29	32.8	2.54	64.5	NS	Y	Y	Y	Y	Y	
B2-JCFX-0806S	14400-0806S	20424925	1/2	12.7	9/16-18	3/4	19	3/4	19	1.29	32.8	2.54	64.5	NS	Y	Y	Y	Y	Y	
B2-JCFX-0808	14400-0808	20242008	1/2	12.7	3/4-16	1	25	3/4	19	1.44	36.7	2.69	68.4	NS	Y	Y	Y	Y	Y	
B2-JCFX-0808S	14400-0808S	20286839	1/2	12.7	3/4-16	1	25	3/4	19	1.44	36.7	2.69	68.4	NS	Y	Y	Y	Y	Y	
B2-JCFX-0810	14400-0810	20242036	1/2	12.7	7/8-14	1 1/16	27	7/8	22	1.56	39.6	2.81	71.3	NS	Y	Y	Y	Y	Y	
B2-JCFX-0810S	14400-0810S	20286840	1/2	12.7	7/8-14	1 1/16	27	7/8	22	1.56	39.6	2.81	71.3	NS	Y	Y	Y	Y	Y	
B2-JCFX-0812	14400-0812	20241925	1/2	12.7	1 1/16-12	1 1/4	32	1	25	1.68	42.6	2.93	74.3	NS	Y	Y	Y	Y	Y	
B2-JCFX-0816	14400-0816	20293244	1/2	12.7	1 5/16-12	1 1/2	38	1 1/4	32	1.83	46.5	3.08	78.2	NS	Y	Y	Y	Y	Y	
B2-JCFX-1008	14400-1008	20242005	5/8	15.9	3/4-16	1	25	15/16	24	1.52	38.7	2.88	73.2	NS	Y	Y	Y	Y	Y	
B2-JCFX-1010	14400-1010	20242004	5/8	15.9	7/8-14	1 1/16	27	15/16	24	1.67	42.4	3.03	76.9	NS	Y	Y	Y	Y	Y	
B2-JCFX-1010S	14400-1010S	20286841	5/8	15.9	7/8-14	1 1/16	27	15/16	24	1.67	42.4	3.03	76.9	NS	Y	Y	Y	Y	Y	
B2-JCFX-1012	14400-1012	20242026	5/8	15.9	1 1/16-12	1 1/4	32	1	25	1.68	42.6	3.04	77.1	NS	Y	Y	Y	Y	Y	
B2-JCFX-1210	14400-1210	20242047	3/4	19.0	7/8-14	1 1/4	32	1 1/16	27	1.63	41.4	3.18	80.8	NS	Y	Y	Y	Y	Y	
B2-JCFX-1212	14400-1212	20242025	3/4	19.0	1 1/16-12	1 1/4	32	1 1/16	27	1.74	44.2	3.29	83.6	NS	Y	Y	Y	Y	Y	
B2-JCFX-1212S	14400-1212S	20286842	3/4	19.0	1 1/16-12	1 1/4	32	1 1/16	27	1.74	44.2	3.29	83.6	NS	Y	Y	Y	Y	Y	
B2-JCFX-1214	14400-1214	20242049	3/4	19.0	1 3/16-12	1 7/16	36	1 1/4	32	1.76	44.6	3.31	84.0	NS	Y	Y	Y	Y	Y	
B2-JCFX-1216	14400-1216	20242046	3/4	19.0	1 5/16-12	1 1/2	38	1 1/4	32	1.89	48.1	3.45	87.5	NS	Y	Y	Y	Y	Y	

S: Stainless Steel

Continued on next page

# JIC 37° Flare (SAE J514)

Female | Swivel Continued

Descriptive #	Product #	SAP #	Hose Size ID		Thread Size (A)		Hex-1 Wrench Size		Hex-2 Wrench Size		Cut-Off (C)		Length (L)		Skive Type	SR15N, DR15N, SFS	SR25N, DR25N, LR25N	SR16SC, XR16SC, ARC16SC, DR16SC	SCP3, XCP3, ACP3	XCP4
			in.	mm	in.	mm	in.	mm	in.	mm	in.	mm	in.	mm						
B2-JCFX-1612	14400-1612	20241921	1	25.4	1 1/16-12	1 1/4	32	1 1/4	32	1.88	47.7	3.65	92.8	NS	Y	Y	Y	Y		
B2-JCFX-1616	14400-1616	20241916	1	25.4	1 5/16-12	1 1/2	38	1 1/4	32	1.96	49.8	3.74	94.9	NS	Y	Y	Y	Y		
B2-JCFX-1616S	14400-1616S	20286843	1	25.4	1 5/16-12	1 1/2	38	1 1/4	32	1.96	49.8	3.74	94.9	NS	Y	Y	Y	Y		
B2-JCFX-1620T	14400-1620	20241919	1	25.4	1 5/8-12	2	50	1 3/8	41	2.07	52.5	3.84	97.6	NS	Y	Y	Y	Y		
S4-JCFX-2020T	28400-2020	20241915	1 1/4	31.8	1 5/8-12	2	50	1 3/8	41	2.15	54.6	4.20	106.6	NS	Y	Y	Y			
S4-JCFX-2020ST	28400-2020S	20289599	1 1/4	31.8	1 5/8-12	2	50	1 3/8	41	2.15	54.6	4.20	106.6	NS	Y	Y	Y			
S4-JCFX-2024T	28400-2024	20293262	1 1/4	31.8	1 7/8-12	2 3/16	55	2	50	2.45	62.1	4.49	114.1	NS	Y	Y	Y			
S4-JCFX-2424T	28400-2424	20241928	1 1/2	38.1	1 7/8-12	2 3/16	55	2	50	2.42	61.4	4.75	120.6	NS	Y	Y				
S4-JCFX-2424ST	28400-2424S	20289598	1 1/2	38.1	1 7/8-12	2 3/16	55	2	50	2.42	61.4	4.75	120.6	NS	Y	Y				
S4-JCFX-3232T	28400-3232	20242028	2	50.8	2 1/2-12	2 3/4	70	2 5/16	65	2.88	73.1	5.71	145.1	NS	Y	Y				
S4-JCFX-3232ST	28400-3232S	20739385	2	50.8	2 1/2-12	2 3/4	70	2 5/16	65	2.88	73.1	5.71	145.1	NS	Y	Y				

T: Thrust-Wire Nut (see "Fitting Identification" in Appendix for details)

S: Stainless Steel

# JIC 37° Flare (SAE J514)

Female | 45° Elbow | Swivel

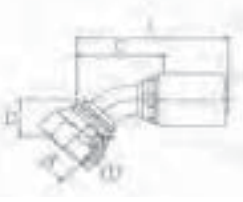

S=Skive  
NS=Non-Skive  
DG=Dual-Grip™

Descriptive #	Product #	SAP #	Hose Size ID		Thread Size (A)		Hex-1 Wrench Size		Drop (D)	Cut-Off (C)	Length (L)		Skive Type	SR15N, DR15N, SFS	SR25N, DR25N, LR25N	SR16SC, XR16SC, ARC16SC, DR16SC	SCP3, XCP3, ACP3	XCP4	
			in.	mm	in.	mm	in.	mm			in.	mm							
B2-JCFX45-0404	14420-0404	20241948	1/4	6.4	7/16-20	5/8	16	0.39	10	1.46	37.0	2.44	61.9	NS	Y	Y	Y	Y	Y
B2-JCFX45-0405	14420-0405	20241962	1/4	6.4	1/2-20	11/16	17	0.47	12	1.46	37.0	2.44	61.9	NS	Y	Y	Y	Y	Y
B2-JCFX45-0406	14420-0406	20241949	1/4	6.4	9/16-18	3/4	19	0.43	11	1.54	39.0	2.52	63.9	NS	Y	Y	Y	Y	Y
B2-JCFX45-0606	14420-0606	20241950	3/8	9.5	9/16-18	3/4	19	0.43	11	1.81	46.0	2.86	72.6	NS	Y	Y	Y	Y	Y
B2-JCFX45-0608	14420-0608	20241954	3/8	9.5	3/4-16	1	25	0.59	15	1.85	47.0	2.90	73.6	NS	Y	Y	Y	Y	Y
B2-JCFX45-0808	14420-0808	20241963	1/2	12.7	3/4-16	1	25	0.59	15	2.05	52.0	3.29	83.7	NS	Y	Y	Y	Y	Y
B2-JCFX45-0810	14420-0810	20241965	1/2	12.7	7/8-14	1 1/16	27	0.63	16	2.01	51.0	3.26	82.7	NS	Y	Y	Y	Y	Y
B2-JCFX45-1010	14420-1010	20241980	5/8	15.9	7/8-14	1 1/16	27	0.75	19	2.44	62.0	3.92	99.5	NS	Y	Y	Y	Y	Y
B2-JCFX45-1012	14420-1012	20241967	5/8	15.9	1 1/16-12	1 1/4	32	0.83	21	2.72	69.0	4.07	103.5	NS	Y	Y	Y	Y	Y
B2-JCFX45-1212	14420-1212	20241951	3/4	19.0	1 1/16-12	1 1/4	32	0.83	21	2.64	67.0	4.19	106.5	NS	Y	Y	Y	Y	Y
B2-JCFX45-1216	14420-1216	20241953	3/4	19.0	1 5/16-12	1 1/2	38	1.02	26	2.80	71.0	4.35	110.4	NS	Y	Y	Y	Y	Y
B2-JCFX45-1612	14420-1612	20293221	1	25.4	1 1/16-12	1 1/4	32	1.18	30	2.76	70.0	4.53	115.1	NS	Y	Y	Y	Y	
B2-JCFX45-1616	14420-1616	20241957	1	25.4	1 5/16-12	1 1/2	38	0.94	24	3.11	79.0	4.89	124.1	NS	Y	Y	Y	Y	
S4-JCFX45-2020T	28420-2020	20241961	1 1/4	31.8	1 5/8-12	2	50	1.46	37	3.82	97.0	5.87	149.0	NS	Y	Y	Y		
S4-JCFX45-2424T	28420-2424	20241960	1 1/2	38.1	1 7/8-12	2 3/16	55	1.69	43	4.45	113.0	6.78	172.2	NS	Y	Y			

T: Thrust-Wire Nut (see "Fitting Identification" in Appendix for details)

# JIC 37° Flare (SAE J514)

Female | 90° Elbow | Swivel

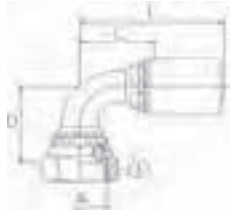

Elbow Type:  
LT=Long Tube  
ST=Short Tube

S=Skive  
NS=Non-Skive  
DG=Dual-Grip™

Descriptive #	Product #	SAP #	Hose Size ID		Thread Size (A)		Hex-1 Wrench Size		Elbow Drop Type (D)		Cut-Off (C)		Length (L)		Skive Type	SR15N, DR15N, SFS	SR25N, DR25N, LR25N	SR16SC, XR16SC, ARC16SC, DR16SC	SCP3, XCP3, ACP3	XCP4
			in.	mm	in.	mm	in.	mm	in.	mm	in.	mm								
B2-JCFX90-0404	14425-0404	20241909	1/4	6.4	7/16-20	5/8	16		1.26	32.0	1.34	34.0	2.32	58.9	NS	Y	Y	Y	Y	Y
B2-JCFX90L-0404	14440-0404	20241985	1/4	6.4	7/16-20	5/8	16	LT	1.81	46.0	1.25	31.8	2.23	56.7	NS	Y	Y	Y	Y	Y
B2-JCFX90S-0404	14445-0404	20241929	1/4	6.4	7/16-20	5/8	16	ST	0.83	21.0	1.06	27.0	2.04	51.9	NS	Y	Y	Y	Y	Y
B2-JCFX90S-0404S	14445-0404S	20797255	1/4	6.4	7/16-20	5/8	16	ST	0.83	21.0	1.06	27.0	2.04	51.9	NS	Y	Y	Y	Y	Y
B2-JCFX90-0405	14425-0405	20241913	1/4	6.4	1/2-20	11/16	17		1.18	30.0	1.02	26.0	2.00	50.9	NS	Y	Y	Y	Y	Y
B2-JCFX90L-0405	14440-0405	20241988	1/4	6.4	1/2-20	11/16	17	LT	1.77	45.0	1.02	26.0	2.00	50.9	NS	Y	Y	Y	Y	Y
B2-JCFX90S-0405	14445-0405	20241938	1/4	6.4	1/2-20	11/16	17	ST	0.93	23.5	1.02	26.0	2.00	50.9	NS	Y	Y	Y	Y	Y
B2-JCFX90-0406	14425-0406	20241896	1/4	6.4	9/16-18	3/4	19		1.50	38.0	1.10	28.0	2.08	52.9	NS	Y	Y	Y	Y	Y
B2-JCFX90L-0406	14440-0406	20241970	1/4	6.4	9/16-18	3/4	19	LT	2.13	54.0	1.34	34.0	2.32	58.9	NS	Y	Y	Y	Y	Y
B2-JCFX90S-0406	14445-0406	20241939	1/4	6.4	9/16-18	3/4	19	ST	0.91	23.0	1.22	31.0	2.20	55.9	NS	Y	Y	Y	Y	Y
B2-JCFX90-0604	14425-0604	20293223	3/8	9.5	7/16-20	5/8	16		1.26	32.0	1.38	35.0	2.43	61.6	NS	Y	Y	Y	Y	Y
B2-JCFX90L-0604	14440-0604	20293222	3/8	9.5	7/16-20	5/8	16	LT	1.81	46.0	1.22	31.0	2.27	57.6	NS	Y	Y	Y	Y	Y
B2-JCFX90S-0604	14445-0604	20265709	3/8	9.5	7/16-20	5/8	16	ST	0.83	21.0	1.10	28.0	2.15	54.6	NS	Y	Y	Y	Y	Y
B2-JCFX90-0606	14425-0606	20241902	3/8	9.5	9/16-18	3/4	19		1.38	35.0	1.22	31.0	2.27	57.6	NS	Y	Y	Y	Y	Y
B2-JCFX90L-0606	14440-0606	20241974	3/8	9.5	9/16-18	3/4	19	LT	2.13	54.0	1.69	43.0	2.74	69.6	NS	Y	Y	Y	Y	Y
B2-JCFX90S-0606	14445-0606	20241944	3/8	9.5	9/16-18	3/4	19	ST	0.91	23.0	1.65	42.0	2.70	68.7	NS	Y	Y	Y	Y	Y
B2-JCFX90-0608	14425-0608	20241895	3/8	9.5	3/4-16	1	25		1.61	41.0	1.54	39.0	2.58	65.6	NS	Y	Y	Y	Y	Y
B2-JCFX90L-0608	14440-0608	20241973	3/8	9.5	3/4-16	1	25	LT	2.52	64.0	1.85	47.0	2.90	73.6	NS	Y	Y	Y	Y	Y
B2-JCFX90S-0608	14445-0608	20241943	3/8	9.5	3/4-16	1	25	ST	1.14	29.0	1.93	49.0	2.98	75.6	NS	Y	Y	Y	Y	Y
B2-JCFX90-0808	14425-0808	20241914	1/2	12.7	3/4-16	1	25		1.58	40.0	1.46	37.0	2.70	68.7	NS	Y	Y	Y	Y	Y
B2-JCFX90L-0808	14440-0808	20241978	1/2	12.7	3/4-16	1	25	LT	2.52	64.0	1.97	50.0	3.22	81.7	NS	Y	Y	Y	Y	Y
B2-JCFX90S-0808	14445-0808	20241936	1/2	12.7	3/4-16	1	25	ST	1.14	29.0	1.81	46.0	3.06	77.7	NS	Y	Y	Y	Y	Y
B2-JCFX90-0808S	14425-0808S	20424924	1/2	12.7	3/4-16	1	25		1.58	40.0	1.46	37.0	2.70	68.7	NS	Y	Y	Y	Y	Y
B2-JCFX90-0810	14425-0810	20241911	1/2	12.7	7/8-14	1 1/16	27		1.85	47.0	1.69	43.0	2.94	74.7	NS	Y	Y	Y	Y	Y
B2-JCFX90L-0810	14440-0810	20241987	1/2	12.7	7/8-14	1 1/16	27	LT	2.56	65.0	1.46	37.0	2.70	68.7	NS	Y	Y	Y	Y	Y
B2-JCFX90S-0810	14445-0810	20241946	1/2	12.7	7/8-14	1 1/16	27	ST	1.26	32.0	1.81	46.0	3.06	77.7	NS	Y	Y	Y	Y	Y
B2-JCFX90-0812	14425-0812	20241908	1/2	12.7	1 1/16-12	1 1/4	32		1.81	46.0	1.46	37.0	2.70	68.7	NS	Y	Y	Y	Y	Y
B2-JCFX90-1010	14425-1010	20241932	5/8	15.9	7/8-14	1 1/16	27		1.89	48.0	1.93	49.0	3.29	83.5	NS	Y	Y	Y	Y	Y
B2-JCFX90L-1010	14440-1010	20241976	5/8	15.9	7/8-14	1 1/16	27	LT	2.56	65.0	1.97	50.0	3.32	84.4	NS	Y	Y	Y	Y	Y
B2-JCFX90S-1010	14445-1010	20241923	5/8	15.9	7/8-14	1 1/16	27	ST	1.26	32.0	1.93	49.0	3.29	83.5	NS	Y	Y	Y	Y	Y
B2-JCFX90-1012	14425-1012	20241930	5/8	15.9	1 1/16-12	1 1/4	32		2.28	58.0	1.89	48.0	3.25	82.5	NS	Y	Y	Y	Y	Y
B2-JCFX90S-1012	14445-1012	20241945	5/8	15.9	1 1/16-12	1 1/4	32	ST	1.89	48.0	1.89	48.0	3.25	82.5	NS	Y	Y	Y	Y	Y
B2-JCFX90S-1208	14445-1208	20265741	3/4	19.0	3/4-16	1	25	ST	1.14	29.0	1.65	42.0	3.21	81.5	NS	Y	Y	Y	Y	Y
B2-JCFX90-1210	14425-1210	20293224	3/4	19.0	7/8-14	1 1/16	27		1.89	48.0	1.97	50.0	3.52	89.5	NS	Y	Y	Y	Y	Y
B2-JCFX90-1212	14425-1212	20241897	3/4	19.0	1 1/16-12	1 1/4	32		2.13	54.0	2.05	52.0	3.60	91.4	NS	Y	Y	Y	Y	Y
B2-JCFX90L-1212	14440-1212	20241971	3/4	19.0	1 1/16-12	1 1/4	32	LT	3.74	95.0	2.13	54.0	3.68	93.4	NS	Y	Y	Y	Y	Y

T: Thrust-Wire Nut (see "Fitting Identification" in Appendix for details)

S: Stainless Steel

Continued on next page

# JIC 37° Flare (SAE J514)

## Female 90° | Elbow | Swivel Continued

Descriptive #	Product #	SAP #	Hose Size ID		Thread Size (A)		Hex-1 Wrench Size		Elbow Type	Drop (D)		Cut-Off (C)		Length (L)		Skive Type	SR15N, DR15N, SFS	SR25N, DR25N, LR25N	SR16SC, XR16SC, ARC16SC, DR16SC	SCP3, XCP3, ACP3	XCP4
			in.	mm	in.	mm	in.	mm		in.	mm	in.	mm	in.	mm						
B2-JCFX90S-1212	14445-1212	20241940	3/4	19.0	1 1/16-12	1 1/4	32	ST	1.81	46.0	2.28	58.0	3.84	97.4	NS	Y	Y	Y	Y	Y	
B2-JCFX90S-1212S	14445-1212S	20797257	3/4	19.0	1 1/16-12	1 1/4	32	ST	1.81	46.0	2.28	58.0	3.84	97.4	NS	Y	Y	Y	Y	Y	
B2-JCFX90S-1214	14445-1214	20241942	3/4	19.0	1 3/16-12	1 7/16	36	ST	2.07	52.6	1.93	49.0	3.48	88.5	NS	Y	Y	Y	Y	Y	
B2-JCFX90-1216	14425-1216	20241900	3/4	19.0	1 5/16-12	1 1/2	38		2.84	72.0	2.09	53.0	3.64	92.5	NS	Y	Y	Y	Y	Y	
B2-JCFX90S-1216	14445-1216	20662000	3/4	19.0	1 5/16-12	1 1/2	38	ST	2.28	57.8	1.99	50.5	3.54	90.0	NS						
B2-JCFX90-1616	14425-1616	20241977	1	25.4	1 5/16-12	1 1/2	38		2.81	71.4	2.89	73.4	4.67	118.5	NS	Y	Y	Y	Y	Y	
B2-JCFX90L-1616	14440-1616	20241983	1	25.4	1 5/16-12	1 1/2	38	LT	4.49	114.0	3.11	79.0	4.89	124.1	NS	Y	Y	Y	Y	Y	
B2-JCFX90S-1616	14445-1616	20241934	1	25.4	1 5/16-12	1 1/2	38	ST	2.21	56.0	2.91	74.0	4.69	119.1	NS	Y	Y	Y	Y	Y	
B2-JCFX90S-1616S	14445-1616S	20797550	1	25.4	1 5/16-12	1 1/2	38	ST	2.21	56.0	2.91	74.0	4.69	119.1	NS	Y	Y	Y	Y	Y	
S4-JCFX90-2020 <sup>T</sup>	28425-2020	20241906	1 1/4	31.8	1 5/8-12	2	50		3.07	78.0	3.23	82.0	5.28	134.0	NS	Y	Y	Y			
S4-JCFX90-2024 <sup>T</sup>	28425-2024	20432492	1 1/4	31.8	1 7/8-12	2 3/16	55								NS	Y	Y	Y			
S4-JCFX90-2424 <sup>T</sup>	28425-2424	20241904	1 1/2	38.1	1 7/8-12	2 3/16	55		3.62	91.9	3.94	100.0	6.27	159.1	NS	Y	Y				
S4-JCFX90-3232 <sup>T</sup>	28425-3232	20657096	2	50.8	2 1/2-12	2 3/4	70								NS	Y	Y				

T: Thrust-Wire Nut (see "Fitting Identification" in Appendix for details)

S: Stainless Steel

# JIC 37° Flare (SAE J514)

## Male

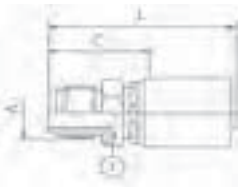

S=Skive  
NS=Non-Skive  
DG=Dual-Grip™

Descriptive #	Product #	SAP #	Hose Size ID		Thread Size (A)		Hex-1 Wrench Size		Cut-Off (C)	Length (L)		Skive Type	SR15N, DR15N, SFS	SR25N, DR25N, LR25N	SR16SC, XR16SC, ARC16SC, DR16SC	SCP3, XCP3, ACP3	XCP4
			in.	mm	in.	mm	in.	mm		in.	mm						
B2-JCM-0404	14450-0404	20241990	1/4	6.4	7/16-20	1/2	12	0.99	25.2	1.97	50.1	NS	Y	Y	Y	Y	Y
B2-JCM-0405	14450-0405	20241991	1/4	6.4	1/2-20	9/16	14	1.03	26.2	2.01	51.1	NS	Y	Y	Y	Y	Y
B2-JCM-0406	14450-0406	20241995	1/4	6.4	9/16-18	11/16	17	1.04	26.4	2.02	51.3	NS	Y	Y	Y	Y	Y
B2-JCM-0506	14450-0506	20242012	5/16	7.9	9/16-18	11/16	17	1.04	26.5	2.02	51.4	NS	Y				
B2-JCM-0606	14450-0606	20242014	3/8	9.5	9/16-18	11/16	17	1.05	26.6	2.10	53.2	NS	Y	Y	Y	Y	Y
B2-JCM-0608	14450-0608	20242007	3/8	9.5	3/4-16	3/4	19	1.14	28.9	2.19	55.5	NS	Y	Y	Y	Y	Y
B2-JCM-0610	14450-0610	20242024	3/8	9.5	7/8-14	15/16	24	1.33	33.8	2.38	60.5	NS	Y	Y	Y	Y	Y
B2-JCM-0808	14450-0808	20241994	1/2	12.7	3/4-16	3/4	19	1.17	29.8	2.42	61.4	NS	Y	Y	Y	Y	Y
B2-JCM-0808S	14450-0808S	20424921	1/2	12.7	3/4-16			1.17	29.8	2.42	61.4	NS	Y	Y	Y	Y	Y
B2-JCM-0810	14450-0810	20241993	1/2	12.7	7/8-14	15/16	24	1.35	34.4	2.60	66.0	NS	Y	Y	Y	Y	Y
B2-JCM-0812	14450-0812	20241997	1/2	12.7	1 1/16-12	1 1/16	27	1.46	37.1	2.71	68.7	NS	Y	Y	Y	Y	Y
B2-JCM-1008	14450-1008	20441227	5/8	15.9	3/4-16	15/16	24	1.21	30.8	2.57	65.3	NS	Y	Y	Y	Y	Y
B2-JCM-1010	14450-1010	20242010	5/8	15.9	7/8-14	15/16	24	1.38	35.0	2.73	69.4	NS	Y	Y	Y	Y	Y
B2-JCM-1012	14450-1012	20242011	5/8	15.9	1 1/16-12	1 1/16	27	1.46	37.1	2.82	71.5	NS	Y	Y	Y	Y	Y

S: Stainless Steel

Continued on next page

# JIC 37° Flare (SAE J514)

Male Continued

Descriptive #	Product #	SAP #	Hose Size ID		Thread Size (A)		Hex-1 Wrench Size		Cut-Off (C)		Length (L)		Skive Type	SR1SN, DR1SN, SFS	SR2SN, DR2SN, LR2SN	SR16SC, XR16SC, ARC16SC, DR16SC	SCP3, XCP3, ACP3	XCP4
			in.	mm	in.	mm	in.	mm	in.	mm	in.	mm						
			B2-JCM-1210	14450-1210	20293165	3/4	19.0	7/8-14	1 1/16	27	1.38	35.0						
B2-JCM-1212	14450-1212	20242022	3/4	19.0	1 1/16-12	1 1/16	27	1.48	37.7	3.04	77.1	NS	Y	Y	Y	Y	Y	
B2-JCM-1214	14450-1214	20242020	3/4	19.0	1 3/16-12	1 1/4	32	1.62	41.0	3.17	80.5	NS	Y	Y	Y	Y	Y	
B2-JCM-1216	14450-1216	20242018	3/4	19.0	1 5/16-12	1 7/16	36	1.66	42.2	3.21	81.6	NS	Y	Y	Y	Y	Y	
B2-JCM-1616	14450-1616	20242002	1	25.4	1 5/16-12	1 7/16	36	1.67	42.4	3.45	87.5	NS	Y	Y	Y	Y		
B2-JCM-1620	14450-1620	20242016	1	25.4	1 7/8-12	1 7/8	46	1.84	46.8	3.62	91.9	NS	Y	Y	Y	Y		
S4-JCM-2020	28450-2020	20241999	1 1/4	31.8	1 7/8-12	1 7/8	46	1.91	48.6	3.96	100.5	NS	Y	Y	Y			
S4-JCM-2024	28450-2024	20241998	1 1/4	31.8	1 7/8-12	2	50	2.08	52.8	4.12	104.7	NS	Y	Y	Y			
S4-JCM-2424	28450-2424	20242027	1 1/2	38.1	1 7/8-12	2	50	2.08	52.7	4.40	111.8	NS	Y	Y				
S4-JCM-3232	28450-3232	20242023	2	50.8	2 1/2-12	2 9/16	65	2.45	62.1	5.28	134.1	NS	Y	Y				

# SAE 45° J512 Flare

Female | Swivel

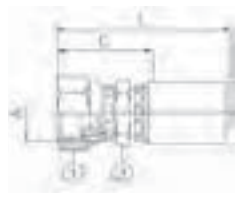

S=Skive  
NS=Non-Skive  
DG=Dual-Grip™

Descriptive #	Product #	SAP #	Hose Size ID		Thread Size (A)		Hex-1 Wrench Size		Hex-2 Wrench Size		Cut-Off (C)		Length (L)		Skive Type	SR1SN, DR1SN, SFS	SR2SN, DR2SN, LR2SN	SR16SC, XR16SC, ARC16SC, DR16SC	SCP3, XCP3, ACP3	XCP4
			in.	mm	in.	mm	in.	mm	in.	mm	in.	mm	in.	mm						
			B2-SFFX-0606	14775-0606	20241706	3/8	9.5	5/8-18	7/8	22	3/4	19	1.32	33.6						
B2-SFFX-0608	14775-0608	20293245	3/8	9.5	3/4-16	1	25	3/4	19	1.37	34.9	2.42	61.5	NS	Y	Y	Y	Y	Y	
B2-SFFX-0808	14775-0808	20662003	1/2	12.7	3/4-16									NS	Y	Y	Y	Y	Y	
B2-SFFX-0810	14775-0810	20293246	1/2	12.7	7/8-14	1 1/16	27	7/8	22	1.60	40.6	2.85	72.3	NS	Y	Y	Y	Y	Y	
B2-SFFX-1212	14775-1212	20241707	3/4	19.0	1 1/16-14	1 1/4	32	1 1/16	27	1.74	44.2	3.29	83.6	NS	Y	Y	Y	Y	Y	

# SAE 45° J512 Flare

Female | 45° Elbow | Swivel

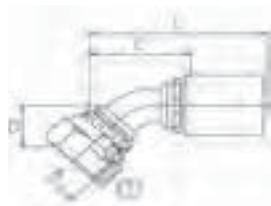

S=Skive  
NS=Non-Skive  
DG=Dual-Grip™

Descriptive #	Product #	SAP #	Hose Size ID		Thread Size (A)		Hex-1 Wrench Size		Hex-2 Wrench Size		Cut-Off (C)		Length (L)		Skive Type	SR1SN, DR1SN, SFS	SR2SN, DR2SN, LR2SN	SR16SC, XR16SC, ARC16SC, DR16SC	SCP3, XCP3, ACP3	XCP4
			in.	mm	in.	mm	in.	mm	in.	mm	in.	mm	in.	mm						
			B2-SFFX45-0606	14777-0606	20293247	3/8	9.5	5/8-18	7/8	22	0.47	12.0	1.81	46.0						
B2-SFFX45-0808	14777-0808	20293248	1/2	12.7	3/4-16	1	25	0.59	15.0	2.05	52.0	3.29	83.7	NS	Y	Y	Y	Y	Y	
B2-SFFX45-1212	14777-1212	20441271	3/4	19.0	1 1/16-14	1 1/4	32	0.83	21.0	2.64	67.0	4.19	106.5	NS	Y	Y	Y	Y	Y	

## SAE 45° J512 Flare

Female 90° | Elbow | Swivel

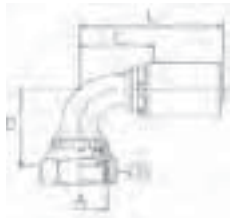

S=Skive  
NS=Non-Skive  
DG=Dual-Grip™

Descriptive #	Product #	SAP #	Hose Size ID		Thread Size (A)		Hex-1 Wrench Size		Drop (D)		Cut-Off (C)		Length (L)		Skive Type	SR1SN, DR1SN, SFS	SR2SN, DR2SN, LR2SN	SR16SC, XR16SC, ARC16SC, DR16SC	SCP3, XCP3, ACP3	XCP4
			in.	mm	in.	mm	in.	mm	in.	mm	in.	mm	in.	mm						
B2-SFFX90-0606	14780-0606	20293249	3/8	9.5	5/8-18	7/8	22	0.95	24.0	1.65	42.0	2.70	68.7	NS	Y	Y	Y	Y	Y	
B2-SFFX90L-0606	14781-0606	20293250	3/8	9.5	5/8-18	7/8	22	2.19	55.5	1.69	43.0	2.74	69.6	NS	Y	Y	Y	Y	Y	
B2-SFFX90S-0808	14783-0808	20293251	1/2	12.7	3/4-16	1	25	1.14	29.0	1.81	46.0	3.06	77.7	NS	Y	Y	Y	Y	Y	
B2-SFFX90-1212	14780-1212	20441304	3/4	19.0	1 1/16-14	1 1/4	32	1.85	47.0	1.69	43.0	2.94	74.7	NS	Y	Y	Y	Y	Y	

## SAE 45° J512 Flare

Male

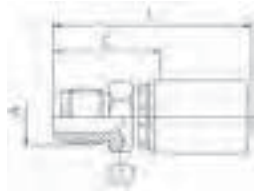

S=Skive  
NS=Non-Skive  
DG=Dual-Grip™

Descriptive #	Product #	SAP #	Hose Size ID		Thread Size (A)		Hex-1 Wrench Size		Cut-Off (C)		Length (L)		Skive Type	SR1SN, DR1SN, SFS	SR2SN, DR2SN, LR2SN	SR16SC, XR16SC, ARC16SC, DR16SC	SCP3, XCP3, ACP3	XCP4
			in.	mm	in.	mm	in.	mm	in.	mm								
B2-SFM-0606	14785-0606	20293213	3/8	9.5	5/8-18	5/8	16	1.12	28.5	2.17	55.2	NS	Y	Y	Y	Y	Y	
B2-SFM-0608	14785-0608	20293214	3/8	9.5	3/4-16	3/4	19	1.23	31.2	2.28	57.9	NS	Y	Y	Y	Y	Y	
B2-SFM-0808	14785-0808	20293215	1/2	12.7	3/4-16	3/4	19	1.27	32.1	2.51	63.8	NS	Y	Y	Y	Y	Y	
B2-SFM-1212	14785-1212	20293216	3/4	19.0	1 1/16-14	1 1/16	27	1.62	41.1	3.17	80.6	NS	Y	Y	Y	Y	Y	

## SAE 45° Inverted Flare

Male | Swivel



S=Skive  
NS=Non-Skive  
DG=Dual-Grip™

Descriptive #	Product #	SAP #	Hose Size ID		Thread Size (A)		Hex-1 Wrench Size		Cut-Off (C)		Length (L)		Skive Type	SR1SN, DR1SN, SFS	SR2SN, DR2SN, LR2SN	SR16SC, XR16SC, ARC16SC, DR16SC	SCP3, XCP3, ACP3	XCP4
			in.	mm	in.	mm	in.	mm	in.	mm								
B2-SIMX-0403	14800-0403	20293166	1/4	6.4	3/8-24	1/2	12	1.68	42.7	2.66	67.6	NS	Y	Y	Y	Y	Y	
B2-SIMX-0404	14800-0404	20293167	1/4	6.4	7/16-24	1/2	12	1.70	43.1	2.68	67.9	NS	Y	Y	Y	Y	Y	
B2-SIMX-0405	14800-0405	20293168	1/4	6.4	1/2-20	9/16	14	1.83	46.6	2.81	71.5	NS	Y	Y	Y	Y	Y	

Continued on next page

# SAE 45° Inverted Flare

Male | Swivel Continued

Descriptive #	Product #	SAP #	Hose Size ID		Thread Size (A)		Hex-1 Wrench Size		Cut-Off (C)				Skive Type	SR1SN, DR1SN, SFS	SR2SN, DR2SN, LR2SN	SR16SC, XR16SC, ARC16SC, DR16SC	SCP3, XCP3, ACP3	XCP4
			in.	mm	in.	mm	in.	mm	in.	mm	in.	mm						
			B2-SIMX-0605	14800-0605	20293169	3/8	9.5	1/2-20	9/16	14	1.84	46.8						
B2-SIMX-0606	14800-0606	20293170	3/8	9.5	5/8-18	11/16	17	1.89	48.0	2.94	74.7	NS	Y	Y	Y	Y	Y	
B2-SIMX-0607	14800-0607	20293171	3/8	9.5	11/16-18	3/4	19	1.92	48.7	2.965	75.3	NS	Y	Y	Y	Y	Y	
B2-SIMX-0808	14800-0808	20293172	1/2	12.7	3/4-18	3/4	19	2.00	50.8	3.248	82.5	NS	Y	Y	Y	Y	Y	
B2-SIMX-0810	14800-0810	20293173	1/2	12.7	7/8-18	15/16	24	2.07	52.7	3.321	84.4	NS	Y	Y	Y	Y	Y	

# SAE 45° Inverted Flare

Male 45° Elbow | Swivel

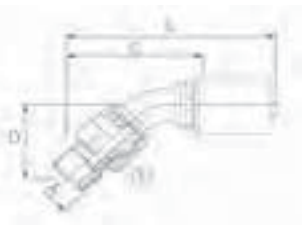

S=Skive  
NS=Non-Skive  
DG=Dual-Grip™

Descriptive #	Product #	SAP #	Hose Size ID		Thread Size (A)		Hex-1 Wrench Size		Drop (D)				Cut-Off (C)				Skive Type	SR1SN, DR1SN, SFS	SR2SN, DR2SN, LR2SN	SR16SC, XR16SC, ARC16SC, DR16SC	SCP3, XCP3, ACP3	XCP4
			in.	mm	in.	mm	in.	mm	in.	mm	in.	mm	in.	mm	in.	mm						
			B2-SIMX45-0403	14810-0403	20293174	1/4	6.4	3/8-24	1/2	12	1.24	31.5	2.68	68.1	3.66	93.0						
B2-SIMX45-0404	14810-0404	20293175	1/4	6.4	7/16-24	1/2	12	1.24	31.5	2.68	68.1	3.66	93.0	NS	Y	Y	Y	Y	Y			
B2-SIMX45-0604	14810-0604	20293382	3/8	9.5	7/16-24	1/2	12	1.57	39.9	2.95	74.9	4.00	101.6	NS	Y	Y	Y	Y	Y			
B2-SIMX45-0605	14810-0605	20293177	3/8	9.5	1/2-20	9/16	14	1.50	38.1	2.99	75.9	4.04	102.6	NS	Y	Y	Y	Y	Y			
B2-SIMX45-0606	14810-0606	20293178	3/8	9.5	5/8-18	11/16	17	1.50	38.1	2.99	75.9	4.04	102.6	NS	Y	Y	Y	Y	Y			
B2-SIMX45-0607	14810-0607	20293179	3/8	9.5	11/16-18	3/4	19	1.50	38.1	2.99	75.9	4.04	102.6	NS	Y	Y	Y	Y	Y			

# SAE 45° Inverted Flare

Male | 90° Elbow | Swivel

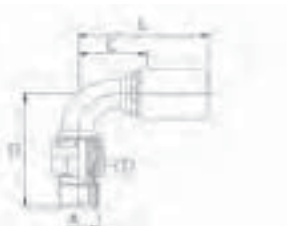

S=Skive  
NS=Non-Skive  
DG=Dual-Grip™

Descriptive #	Product #	SAP #	Hose Size ID		Thread Size (A)		Hex-1 Wrench Size		Drop (D)				Cut-Off (C)				Skive Type	SR1SN, DR1SN, SFS	SR2SN, DR2SN, LR2SN	SR16SC, XR16SC, ARC16SC, DR16SC	SCP3, XCP3, ACP3	XCP4
			in.	mm	in.	mm	in.	mm	in.	mm	in.	mm	in.	mm	in.	mm						
			B2-SIMX90-0403	14815-0403	20293180	1/4	6.4	3/8-24	1/2	12	1.97	50.0	1.38	35.1	2.36	59.9						
B2-SIMX90-0404	14815-0404	20293181	1/4	6.4	7/16-24	1/2	12	2.05	52.1	1.30	33.0	2.28	57.9	NS	Y	Y	Y	Y	Y			
B2-SIMX90-0405	14815-0405	20293182	1/4	6.4	1/2-20	9/16	14	1.96	49.8	1.52	38.6	2.50	63.5	NS	Y	Y	Y	Y	Y			

Continued on next page



# SAE 45° Inverted Flare

Male | 90° Elbow | Swivel Continued

Descriptive #	Product #	SAP #	Hose Size ID		Thread Size (A)		Hex-1 Wrench Size		Drop (D)		Cut-Off (C)		Length (L)		Skive Type	SR1SN, DR1SN, SFS	SR2SN, DR2SN, LR2SN	SR16SC, XR16SC, ARC16SC, DR16SC	SCP3, XCP3, ACP3	XCP4
			in.	mm	in.	mm	in.	mm	in.	mm	in.	mm	in.	mm						
B2-SIMX90-0604	14815-0604	20293183	3/8	9.5	7/16-24	1/2	12	2.44	62.0	1.34	34.0	2.39	60.7	NS	Y	Y	Y	Y	Y	Y
B2-SIMX90-0605	14815-0605	20293184	3/8	9.5	1/2-20	9/16	14	2.44	62.0	1.38	35.1	2.43	61.7	NS	Y	Y	Y	Y	Y	Y
B2-SIMX90-0606	14815-0606	20293185	3/8	9.5	5/8-18	11/16	17	2.44	62.0	1.38	35.1	2.43	61.7	NS	Y	Y	Y	Y	Y	Y
B2-SIMX90-0607	14815-0607	20293186	3/8	9.5	11/16-18	3/4	19	2.44	62.0	1.38	35.1	2.43	61.7	NS	Y	Y	Y	Y	Y	Y
B2-SIMX90-0808	14815-0808	20293187	1/2	12.7	3/4-18	3/4	19	2.32	58.9	2.13	54.1	3.38	85.8	NS	Y	Y	Y	Y	Y	Y

# NPTF

Female

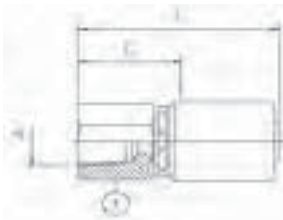

S=Skive  
NS=Non-Skive  
DG=Dual-Grip™

Descriptive #	Product #	SAP #	Hose Size ID		Thread Size (A)		Hex-1 Wrench Size		Cut-Off (C)		Length (L)		Skive Type	SR1SN, DR1SN, SFS	SR2SN, DR2SN, LR2SN	SR16SC, XR16SC, ARC16SC, DR16SC	SCP3, XCP3, ACP3	XCP4
			in.	mm	in.	mm	in.	mm	in.	mm								
B2-NPF-0402	14600-0402	20293225	1/4	6.4	1/8-27	9/16	14	0.88	22.4	1.86	47.3	NS	Y	Y	Y	Y	Y	Y
B2-NPF-0404	14600-0404	20242105	1/4	6.4	1/4-18	3/4	19	1.09	27.6	2.07	52.5	NS	Y	Y	Y	Y	Y	Y
B2-NPF-0604	14600-0604	20293226	3/8	9.5	1/4-18	3/4	19	1.09	27.8	2.14	54.4	NS	Y	Y	Y	Y	Y	Y
B2-NPF-0606	14600-0606	20242103	3/8	9.5	3/8-18	7/8	22	1.15	29.2	2.20	55.8	NS	Y	Y	Y	Y	Y	Y
B2-NPF-0608	14600-0608	20662001	3/8	9.5	1/2-14			1.38	35.0	2.43	61.7		Y	Y	Y	Y	Y	Y
B2-NPF-0806	14600-0806	20662002	1/2	12.7	3/8-18								Y	Y	Y	Y	Y	Y
B2-NPF-0808	14600-0808	20242106	1/2	12.7	1/2-14	1	25	1.4	35.6	2.65	67.2	NS	Y	Y	Y	Y	Y	Y
B2-NPF-1212	14600-1212	20242104	3/4	19.0	3/4-14	1 1/4	32	1.51	38.4	3.06	77.8	NS	Y	Y	Y	Y	Y	Y

# NPTF

Female | Swivel

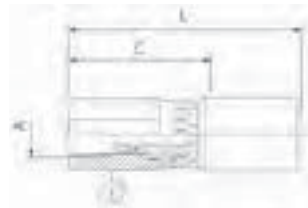

S=Skive  
NS=Non-Skive  
DG=Dual-Grip™

Descriptive #	Product #	SAP #	Hose Size ID		Thread Size (A)		Hex-1 Wrench Size		Cut-Off (C)		Length (L)		Skive Type	SR1SN, DR1SN, SFS	SR2SN, DR2SN, LR2SN	SR16SC, XR16SC, ARC16SC, DR16SC	SCP3, XCP3, ACP3	XCP4
			in.	mm	in.	mm	in.	mm	in.	mm								
B2-NPFX-0606	14605-0606	20293227	3/8	9.5	3/8-18	7/8	22	2.06	52.4	3.11	79.0	NS	Y	Y	Y	Y	Y	Y
B2-NPFX-1616	14605-1616	20293228	1	25.4	1-11 1/2	1 1/2	38	2.83	71.8	4.6	116.9	NS	Y	Y	Y	Y	Y	Y

# NPTF

Male

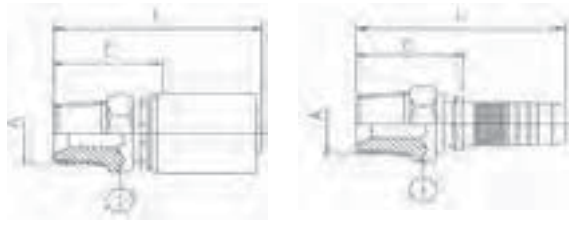

S=Skive  
NS=Non-Skive  
DG=Dual-Grip™

Fittings

Equipment & Accessories

Assemblies

Installation & Maintenance

Appendix

Descriptive #	Product #	SAP #	Hose Size ID		Thread Size (A)		Hex-1 Wrench Size		Cut-Off (C)		Length (L)		Skive Type	SR1SN, DR1SN, SFS	SR2SN, DR2SN, LR2SN	SR16SC, XR16SC, ARC16SC, DR16SC	SCP3, XCP3, ACP3	XCP4
			in.	mm	in.	mm	in.	mm	in.	mm								
UC-NPM-0302	36615-0302	20242703	3/16	4.8	1/8-27	1/2	12	0.78	19.7	1.65	41.9	NS	UCF6-03	UCF6-03				
B2-NPM-0402	14615-0402	20242110	1/4	6.4	1/8-27	9/16	14	0.84	21.2	1.82	46.1	NS	Y	Y	Y	Y	Y	
B2-NPM-0404	14615-0404	20242111	1/4	6.4	1/4-18	11/16	17	1.06	27.0	2.04	51.9	NS	Y	Y	Y	Y	Y	
B2-NPM-0404S	14615-0404S	20286649	1/4	6.4	1/4-18	11/16	17	1.06	27.0	2.04	51.9	NS	Y	Y	Y	Y	Y	
B2-NPM-0406	14615-0406	20242109	1/4	6.4	3/8-18	3/4	19	1.09	27.7	2.07	52.6	NS	Y	Y	Y	Y	Y	
B2-NPM-0408	14615-0408	20242115	1/4	6.4	1/2-14	7/8	22	1.27	32.2	2.25	57.1	NS	Y	Y	Y	Y	Y	
B2-NPM-0604	14615-0604	20242067	3/8	9.5	1/4-18	11/16	17	1.07	27.2	2.12	53.8	NS	Y	Y	Y	Y	Y	
B2-NPM-0606	14615-0606	20242069	3/8	9.5	3/8-18	3/4	19	1.10	27.9	2.15	54.6	NS	Y	Y	Y	Y	Y	
B2-NPM-0606S	14615-0606S	20286830	3/8	9.5	3/8-18	3/4	19	1.10	27.9	2.15	54.6	NS	Y	Y	Y	Y	Y	
B2-NPM-0608	14615-0608	20242079	3/8	9.5	1/2-14	7/8	22	1.27	32.4	2.32	59.0	NS	Y	Y	Y	Y	Y	
B2-NPM-0806	14615-0806	20242113	1/2	12.7	3/8-18	3/4	19	1.12	28.4	2.37	60.1	NS	Y	Y	Y	Y	Y	
B2-NPM-0806S	14615-0806S	20424922	1/2	12.7	3/8-18	3/4		1.12	28.4	2.37	60.1		Y	Y	Y	Y	Y	
B2-NPM-0808	14615-0808	20242093	1/2	12.7	1/2-14	7/8	22	1.30	33.0	2.55	64.7	NS	Y	Y	Y	Y	Y	
B2-NPM-0808S	14615-0808S	20286831	1/2	12.7	1/2-14	7/8	22	1.30	33.0	2.55	64.7	NS	Y	Y	Y	Y	Y	
B2-NPM-0812	14615-0812	20242116	1/2	12.7	3/4-14	1 1/16	27	1.34	34.1	2.59	65.8	NS	Y	Y	Y	Y	Y	
B2-NPM-1008	14615-1008	20242071	5/8	15.9	1/2-14	15/16	24	1.31	33.3	2.67	67.7	NS	Y	Y	Y	Y	Y	
B2-NPM-1008S	14615-1008S	20286832	5/8	15.9	1/2-14	15/16	24	1.31	33.3	2.67	67.7	NS	Y	Y	Y	Y	Y	
B2-NPM-1012	14615-1012	20242066	5/8	15.9	3/4-14	1 1/16	27	1.35	34.4	2.71	68.9	NS	Y	Y	Y	Y	Y	
B2-NPM-1208	14615-1208	20242078	3/4	19.0	1/2-14	1 1/16	27	1.32	33.5	2.87	73.0	NS	Y	Y	Y	Y	Y	
B2-NPM-1212	14615-1212	20242076	3/4	19.0	3/4-14	1 1/16	27	1.36	34.6	2.92	74.1	NS	Y	Y	Y	Y	Y	
B2-NPM-1212S	14615-1212S	20286833	3/4	19.0	3/4-14	1 1/16	27	1.36	34.6	2.92	74.1	NS	Y	Y	Y	Y	Y	
B2-NPM-1216	14615-1216	20242077	3/4	19.0	1-11 1/2	1 7/16	36	1.72	43.7	3.27	83.1	NS	Y	Y	Y	Y	Y	
B2-NPM-1612	14615-1612	20242107	1	25.4	3/4-14	1 7/16	36	1.56	39.5	3.33	84.6	NS	Y	Y	Y	Y		
B2-NPM-1616	14615-1616	20242099	1	25.4	1-11 1/2	1 7/16	36	1.73	43.9	3.51	89.0	NS	Y	Y	Y	Y		
B2-NPM-1616S	14615-1616S	20286834	1	25.4	1-11 1/2	1 7/16	36	1.73	43.9	3.51	89.0	NS	Y	Y	Y	Y		
B2-NPM-1620	14615-1620	20242092	1	25.4	1 1/4-11 1/2	1 13/16	46	1.88	47.8	3.66	92.8	NS	Y	Y	Y	Y		
S4-NPM-2020	28615-2020	20242094	1 1/4	31.8	1 1/4-11 1/2	1 13/16	46	1.95	49.5	4.00	101.5	NS	Y	Y	Y			
S4-NPM-2020S	28615-2020S	20424930	1 1/4	31.8	1 1/4-11 1/2			1.95	49.5	4.00	101.5		Y	Y	Y			
S4-NPM-2024	28615-2024	20242095	1 1/4	31.8	1 1/2-11 1/2	2	50	2.01	51.0	4.06	103.0	NS	Y	Y	Y			
S4-NPM-2424	28615-2424	20242102	1 1/2	38.1	1 1/2-11 1/2	2	50	2.01	51.0	4.34	110.1	NS	Y	Y				
S4-NPM-2424S	28615-2424S	20424931	1 1/2	38.1	1 1/2-11 1/2			2.01	51.0	4.34	110.1		Y	Y				
S4-NPM-3232	28615-3232	20242108	2	50.8	2-11 1/2	2 3/16	65	2.14	54.5	4.98	126.4	NS	Y	Y				

S: Stainless Steel  
BH: Brass Hybrid

# NPTF

## Male | Swivel

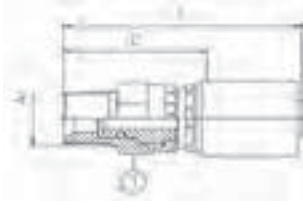

S=Skive  
NS=Non-Skive  
DG=Dual-Grip™

Descriptive #	Product #	SAP #	Hose Size ID		Thread Size (A)		Hex-1 Wrench Size		Cut-Off (C)				Skive Type	SR1SN, DR1SN, SFS	SR2SN, DR2SN, LR2SN	SR16SC, XR16SC, ARC16SC, DR16SC	SCP3, XCP3, ACP3	XCP4
			in.	mm	in.	mm	in.	mm	in.	mm	in.	mm						
B2-NPMX-0402	14645-0402	20435592	1/4	6.4	1/8-27	5/8	16	1.51	38.4	2.49	63.1	NS	Y	Y	Y	Y	Y	
B2-NPMX-0404	14645-0404	20242087	1/4	6.4	1/4-18	11/16	17	1.49	37.8	2.47	62.7	NS	Y	Y	Y	Y	Y	
B2-NPMX-0406	14645-0406	20242086	1/4	6.4	3/8-18	7/8	22	1.57	39.9	2.55	64.8	NS	Y	Y	Y	Y	Y	
B2-NPMX-0604	14645-0604	20242082	3/8	9.5	1/4-18	11/16	17	1.58	40.1	2.63	66.8	NS	Y	Y	Y	Y	Y	
B2-NPMX-0606	14645-0606	20242081	3/8	9.5	3/8-18	7/8	22	1.49	37.8	2.54	64.4	NS	Y	Y	Y	Y	Y	
B2-NPMX-0608	14645-0608	20242083	3/8	9.5	1/2-14	1	25	1.71	43.5	2.76	70.2	NS	Y	Y	Y	Y	Y	
B2-NPMX-0804	14645-0804	20293188	1/2	12.7	1/4-18	11/16	17	1.60	40.6	2.85	72.3	NS	Y	Y	Y	Y	Y	
B2-NPMX-0806	14645-0806	20242088	1/2	12.7	3/8-18	7/8	22	1.51	38.5	2.76	70.1	NS	Y	Y	Y	Y	Y	
B2-NPMX-0808	14645-0808	20242074	1/2	12.7	1/2-14	1	25	1.66	42.3	2.91	73.9	NS	Y	Y	Y	Y	Y	
B2-NPMX-1212	14645-1212	20242091	3/4	19.0	3/4-14	1 1/4	32	1.97	50.1	3.53	89.6	NS	Y	Y	Y	Y	Y	
B2-NPMX-1616	14645-1616	20242085	1	25.4	1-11 1/2	1 3/4	41	2.30	58.4	4.07	103.5	NS	Y	Y	Y	Y	Y	

# NPTF

## Male | 90° Elbow (Block) | Swivel



S=Skive  
NS=Non-Skive  
DG=Dual-Grip™

Descriptive #	Product #	SAP #	Hose Size ID		Thread Size (A)		Hex-1 Wrench Size		Drop (D)		Cut-Off (C)		Length (L)		Skive Type	SR1SN, DR1SN, SFS	SR2SN, DR2SN, LR2SN	SR16SC, XR16SC, ARC16SC, DR16SC	SCP3, XCP3, ACP3	XCP4
			in.	mm	in.	mm	in.	mm	in.	mm	in.	mm								
B2-NPMX90B-0404	14650-0404	20293189	1/4	6.4	1/4-18	11/16	17	1.69	42.9	0.71	18.1	1.69	43.0	NS	Y	Y	Y	Y	Y	
B2-NPMX90B-0604	14650-0604	20293190	3/8	9.5	1/4-18	11/16	17	1.63	41.5	0.92	23.3	1.97	50.0	NS	Y	Y	Y	Y	Y	
B2-NPMX90B-0606	14650-0606	20293191	3/8	9.5	3/8-18	7/8	22	1.62	41.2	0.92	23.3	1.97	50.0	NS	Y	Y	Y	Y	Y	
B2-NPMX90B-0806	14650-0806	20441228	1/2	12.7	3/8-18	7/8	22	2.00	50.7	1.16	29.4	2.41	61.1	NS	Y	Y	Y	Y	Y	
B2-NPMX90B-0808	14650-0808	20293192	1/2	12.7	1/2-14	1	25	2.15	54.6	1.16	29.4	2.41	61.1	NS	Y	Y	Y	Y	Y	
B2-NPMX90B-1212	14650-1212	20293193	3/4	19.0	3/4-14	1 1/4	32	2.58	65.6	1.24	31.5	2.80	71.0	NS	Y	Y	Y	Y	Y	

# NPSM

Female | Swivel

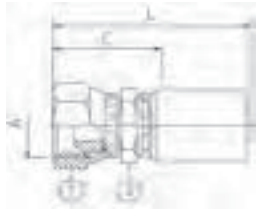

S=Skive  
NS=Non-Skive  
DG=Dual-Grip™

Descriptive #	Product #	SAP #	Hose Size ID		Thread Size (A)	Hex-1 Wrench Size		Hex-2 Wrench Size		Cut-Off (C)		Length (L)		Skive Type	SR1SN, DR1SN, SFS	SR2SN, DR2SN, LR2SN	SR16SC, XR16SC, ARC16SC, DR16SC	SCP3, XCP3, ACP3	XCP4
			in.	mm		in.	mm	in.	mm	in.	mm	in.	mm						
B2-NSFX-0404	14655-0404	20242064	1/4	6.4	1/4-18	3/4	19	11/16	17	1.19	30.2	2.17	55.1	NS	Y	Y	Y	Y	Y
B2-NSFX-0606	14655-0606	20242065	3/8	9.5	3/8-18	7/8	22	3/4	19	1.24	31.4	2.29	58.0	NS	Y	Y	Y	Y	Y
B2-NSFX-0808	14655-0808	20242063	1/2	12.7	1/2-14	1 1/16	27	7/8	22	1.35	34.3	2.60	66.0	NS	Y	Y	Y	Y	Y
B2-NSFX-0808S	14655-0808S	20424926	1/2	12.7	1/2-14					1.35	34.3	2.60	66.0		Y	Y	Y	Y	Y
B2-NSFX-1212	14655-1212	20293252	3/4	19.0	3/4-14	1 1/4	32	1 3/16	30	1.46	37.0	3.01	76.4	NS	Y	Y	Y	Y	Y
B2-NSFX-1616	14655-1616	20293253	1	25.4	1-11 1/2	1 1/2	38	1 7/16	36	1.76	44.7	3.54	89.8	NS	Y	Y	Y	Y	
S4-NSFX-2020	28655-2020	20293263	1 1/4	31.8	1 1/4-11 1/2	2	50	1 1/8	41	2.04	51.7	4.08	103.7	NS	Y	Y	Y		

S: Stainless Steel

# GTF

Female

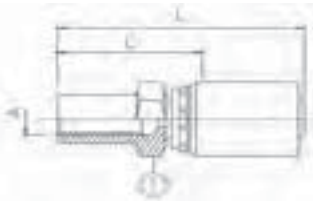

S=Skive  
NS=Non-Skive  
DG=Dual-Grip™

Descriptive #	Product #	SAP #	Hose Size ID		Thread Size (A)	Hex-1 Wrench Size		Cut-Off (C)		Length (L)		Skive Type	SR1SN, DR1SN, SFS	SR2SN, DR2SN, LR2SN	SR16SC, XR16SC, ARC16SC, DR16SC	SCP3, XCP3, ACP3	XCP4
			in.	mm		in.	mm	in.	mm	in.	mm						
B2-GTF-0404	14370-0404	20293254	1/4	6.4	.511-27	3/4	19	0.92	23.3	1.9	48.2	NS	Y	Y	Y	Y	Y

# SAE J514 Flareless Tube Fittings

Male

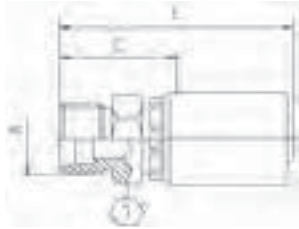

S=Skive  
NS=Non-Skive  
DG=Dual-Grip™

Descriptive #	Product #	SAP #	Hose Size ID		Thread Size (A)		Hex-1 Wrench Size		Cut-Off (C)		Length (L)		Skive Type	SR1SN, DR1SN, SFS	SR2SN, DR2SN, LR2SN	SR16SC, XR16SC, ARC16SC, DR16SC	SCP3, XCP3, ACP3	XCP4
			in.	mm	in.	mm	in.	mm	in.	mm								
B2-FTM-0404	14360-0404	20286101	1/4	6.4	7/16-20	1/2	12	0.88	22.2	1.86	47.1	NS	Y	Y	Y	Y	Y	
B2-FTM-0405	14360-0405	20294798	1/4	6.4	1/2-20	9/16	14	0.90	22.9	1.88	47.8	NS	Y	Y	Y	Y	Y	
B2-FTM-0605	14360-0605	20294799	3/8	9.5	1/2-20	5/8	16	0.96	24.3	2.01	51.0	NS	Y	Y	Y	Y	Y	
B2-FTM-0606	14360-0606	20286102	3/8	9.5	9/16-18	5/8	16	0.97	24.7	2.02	51.4	NS	Y	Y	Y	Y	Y	
B2-FTM-0608	14360-0608	20661908	3/8	9.5	3/4-16			0.97	24.7	2.02	51.4		Y	Y	Y	Y	Y	
B2-FTM-0808	14360-0808	20286103	1/2	12.7	3/4-16	7/8	22	1.11	28.2	2.36	59.9	NS	Y	Y	Y	Y	Y	
B2-FTM-0810	14360-0810	20294860	1/2	12.7	7/8-14	15/16	24	1.21	30.7	2.46	62.4	NS	Y	Y	Y	Y	Y	
B2-FTM-1212	14360-1212	20294861	3/4	19.0	1 1/16-12	1 3/16	30	1.30	33.1	2.85	72.5	NS	Y	Y	Y	Y	Y	
B2-FTM-1616	14360-1616	20294862	1	25.4	1 1/16-12	1 1/8	36	1.48	37.7	3.26	82.8	NS	Y	Y	Y	Y	Y	

\*All Fittings come with Nut and Sleeve

# Standpipe

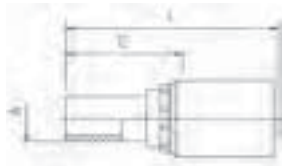

S=Skive  
NS=Non-Skive  
DG=Dual-Grip™

Descriptive #	Product #	SAP #	Hose Size ID		Tube OD (A)		Cut-Off (C)		Length (L)		Skive Type	SR1SN, DR1SN, SFS	SR2SN, DR2SN, LR2SN	SR16SC, XR16SC, ARC16SC, DR16SC	SCP3, XCP3, ACP3	XCP4
			in.	mm	mm	in.	mm	in.	mm							
B2-SP-0406	14825-0406	20441305	1/4	6.4	6	1.11	28.3	2.09	53.2	NS	Y	Y	Y	Y	Y	Y
B2-SP-0408	14825-0408	20241714	1/4	6.4	8	1.19	30.3	2.17	55.2	NS	Y	Y	Y	Y	Y	Y
B2-SP-0410	14825-0410	20241710	1/4	6.4	10	1.27	32.3	2.25	57.2	NS	Y	Y	Y	Y	Y	Y
B2-SP-0610	14825-0610	20241712	3/8	9.5	10	1.19	30.2	2.24	56.9	NS	Y	Y	Y	Y	Y	Y
B2-SP-0612	14825-0612	20241711	3/8	9.5	12	1.15	29.2	2.20	55.9	NS	Y	Y	Y	Y	Y	Y
B2-SP-0815	14825-0815	20241717	1/2	12.7	15	1.26	32.0	2.51	63.7	NS	Y	Y	Y	Y	Y	Y
B2-SP-0816	14825-0816	20241716	1/2	12.7	16	1.46	37.1	2.71	68.8	NS	Y	Y	Y	Y	Y	Y
B2-SP-1018	14825-1018	20241715	5/8	15.9	18	1.35	34.2	2.71	68.7	NS	Y	Y	Y	Y	Y	Y
B2-SP-1020	14825-1020	20241720	5/8	15.9	20	1.73	44.0	3.09	78.5	NS	Y	Y	Y	Y	Y	Y
B2-SP-1222	14825-1222	20241713	3/4	19.0	22	1.44	36.6	2.99	76.0	NS	Y	Y	Y	Y	Y	Y
B2-SP-1628	14825-1628	20241718	1	25.4	28	1.59	40.4	3.37	85.5	NS	Y	Y	Y	Y	Y	Y

\*All Fittings come with Nut and Sleeve

# Standpipe

45° Elbow

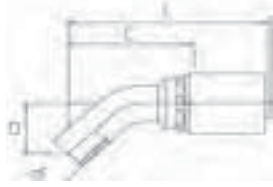

S=Skive  
NS=Non-Skive  
DG=Dual-Grip™

Descriptive #	Product #	SAP #	Hose Size ID		Tube OD (A)	Drop (D)		Cut-Off (C)		Length (L)		Skive Type	SR1SN,	SR2SN,	SR16SC,	SCP3,	XCP4
			in.	mm	mm	in.	mm	in.	mm	in.	mm		in.	mm	DR1SN, SFS	DR2SN, LR2SN	
B2-SP45-0408	14830-0408	20241719	1/4	6.4	8	1.69	42.9	2.67	67.8	NS	Y	NS	Y	Y	Y	Y	Y

# O-Ring Face Seal (SAE J1453 ORS/ORFS)

Female | Swivel

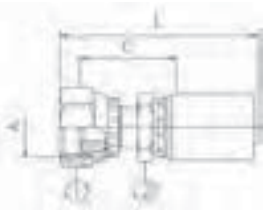

S=Skive  
NS=Non-Skive  
DG=Dual-Grip™

Descriptive #	Product #	SAP #	Hose Size ID		Thread Size (A)	Hex-1 Wrench Size	Hex-2 Wrench Size	Cut-Off (C)		Length (L)		Skive Type	SR1SN,	SR2SN,	SR16SC,	SCP3,	XCP4		
			in.	mm	in.	mm	in.	mm	in.	mm	in.		mm	DR1SN, SFS	DR2SN, LR2SN	XR16SC, ARC16SC, DR16SC		ACP3	
B2-OFFX-0404	14700-0404	20242188	1/4	6.4	9/16-18	11/16	17	9/16	14	1.07	27.3	2.05	52.2	NS	Y	Y	Y	Y	Y
B2-OFFX-0406	14700-0406	20242141	1/4	6.4	11/16-16	7/8	22	11/16	17	1.19	30.1	2.17	55.0	NS	Y	Y	Y	Y	Y
B2-OFFX-0408	14700-0408	20242148	1/4	6.4	13/16-16	15/16	24	7/8	22	1.39	35.4	2.37	60.3	NS	Y	Y	Y	Y	Y
B2-OFFX-0604	14700-0604	20293218	3/8	9.5	9/16-18	11/16	17	11/16	17	1.12	28.4	2.17	55.1	NS	Y	Y	Y	Y	Y
B2-OFFX-0606	14700-0606	20242196	3/8	9.5	11/16-16	7/8	22	11/16	17	1.19	30.3	2.24	56.9	NS	Y	Y	Y	Y	Y
B2-OFFX-0608	14700-0608	20242198	3/8	9.5	13/16-16	15/16	24	7/8	22	1.40	35.6	2.45	62.2	NS	Y	Y	Y	Y	Y
B2-OFFX-0806	14700-0806	20242143	1/2	12.7	11/16-16	7/8	22	3/4	19	1.26	32.0	2.51	63.7	NS	Y	Y	Y	Y	Y
B2-OFFX-0808	14700-0808	20242149	1/2	12.7	13/16-16	15/16	24	7/8	22	1.42	36.1	2.67	67.8	NS	Y	Y	Y	Y	Y
B2-OFFX-0810	14700-0810	20242144	1/2	12.7	1-14	13/16	30	15/16	24	1.56	39.5	2.80	71.2	NS	Y	Y	Y	Y	Y
B2-OFFX-0812	14700-0812	20242136	1/2	12.7	13/16-12	17/16	36	13/16	30	1.66	42.1	2.90	73.8	NS	Y	Y	Y	Y	Y
B2-OFFX-1010	14700-1010	20242178	5/8	15.9	1-14	13/16	30	15/16	24	1.56	39.6	2.92	74.1	NS	Y	Y	Y	Y	Y
B2-OFFX-1012	14700-1012	20242199	5/8	15.9	13/16-12	17/16	36	13/16	30	1.66	42.1	3.01	76.6	NS	Y	Y	Y	Y	Y
B2-OFFX-1210	14700-1210	20242201	3/4	19.0	1-14	13/16	30	11/16	27	1.58	40.1	3.13	79.5	NS	Y	Y	Y	Y	Y
B2-OFFX-1212	14700-1212	20242189	3/4	19.0	13/16-12	17/16	36	13/16	30	1.67	42.3	3.22	81.8	NS	Y	Y	Y	Y	Y
B2-OFFX-1216	14700-1216	20242169	3/4	19.0	17/16-12	15/8	41	17/16	36	1.92	48.6	3.47	88.1	NS	Y	Y	Y	Y	Y
B2-OFFX-1612	14700-1612	20242159	1	25.4	13/16-12	17/16	36	11/16	32	1.79	45.3	3.56	90.4	NS	Y	Y	Y	Y	Y
B2-OFFX-1616	14700-1616	20242142	1	25.4	17/16-12	15/8	41	17/16	36	1.95	49.4	3.72	94.5	NS	Y	Y	Y	Y	Y
B2-OFFX-1620	14700-1620	20242164	1	25.4	111/16-12	2	50	15/8	41	1.98	50.3	3.76	95.4	NS	Y	Y	Y	Y	Y
S4-OFFX-2020	28700-2020	20242137	1 1/4	31.8	111/16-12	2	50	15/8	41	2.08	52.9	4.13	104.9	NS	Y	Y	Y	Y	Y
S4-OFFX-2424	28700-2424	20242138	1 1/2	38.1	2-12	2	60	2	50	2.23	56.7	4.56	115.8	NS	Y	Y	Y	Y	Y

# O-Ring Face Seal (SAE J1453 ORS/ORFS)

Female | 45° Elbow | Swivel

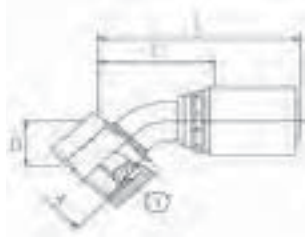

S=Skive  
NS=Non-Skive  
DG=Dual-Grip™

Descriptive #	Product #	SAP #	Hose Size ID		Thread Size (A)	Hex-1 Wrench Size		Drop (D)		Cut-Off (C)		Length (L)		Skive Type	SR15N,	SR25N,	SR16SC,	SCP3,	XCP3,	XCP4
			in.	mm	in.	mm	in.	mm	in.	mm	in.	mm	in.		mm	DR15N,	DR25N,	ARC16SC,		
B2-OFFX45-0404	14710-0404	20242231	1/4	6.4	9/16-18	11/16	17	0.43	10.9	1.61	41.0	2.59	65.9	NS	Y	Y	Y	Y	Y	Y
B2-OFFX45-0406	14710-0406	20242230	1/4	6.4	11/16-16	7/8	22	0.43	10.9	1.81	46.0	2.79	70.9	NS	Y	Y	Y	Y	Y	Y
B2-OFFX45-0606	14710-0606	20242204	3/8	9.5	11/16-16	7/8	22	0.47	11.9	1.85	47.0	2.90	73.6	NS	Y	Y	Y	Y	Y	Y
B2-OFFX45-0608	14710-0608	20242206	3/8	9.5	13/16-16	15/16	24	0.59	15.0	2.01	51.0	3.06	77.6	NS	Y	Y	Y	Y	Y	Y
B2-OFFX45-0808 <sup>C</sup>	14710-0808	20242228	1/2	12.7	13/16-16	15/16	24	0.63	16.0	1.85	47.0	3.10	78.7	NS	Y	Y	Y	Y	Y	Y
B2-OFFX45-0810	14710-0810	20242225	1/2	12.7	1-14	1 3/16	30	0.65	16.5	1.97	50.0	3.22	81.7	NS	Y	Y	Y	Y	Y	Y
B2-OFFX45-1010	14710-1010	20242217	5/8	15.9	1-14	1 3/16	30	0.67	17.0	2.28	58.0	3.64	92.5	NS	Y	Y	Y	Y	Y	Y
B2-OFFX45-1012	14710-1012	20242207	5/8	15.9	1 3/16-12	1 7/16	36	0.83	21.1	2.48	63.0	3.84	97.5	NS	Y	Y	Y	Y	Y	Y
B2-OFFX45-1210	14710-1210	20293219	3/4	19.0	1-14	1 3/16	30	0.79	20.1	2.09	53.1	3.64	92.5	NS	Y	Y	Y	Y	Y	Y
B2-OFFX45-1212	14710-1212	20242232	3/4	19.0	1 3/16-12	1 7/16	36	0.83	21.0	2.48	63.0	4.03	102.4	NS	Y	Y	Y	Y	Y	Y
B2-OFFX45-1216	14710-1216	20242208	3/4	19.0	1 7/16-12	1 5/8	41	0.94	23.9	2.80	71.1	4.35	110.6	NS	Y	Y	Y	Y	Y	Y
B2-OFFX45-1616	14710-1616	20242219	1	25.4	1 7/16-12	1 5/8	41	1.02	26.0	3.23	81.9	5.00	127.1	NS	Y	Y	Y	Y	Y	Y
S4-OFFX45-2020	28710-2020	20242223	1 1/4	31.8	1 11/16-12	2	50	1.02	25.9	3.82	97.0	5.87	149.0	NS	Y	Y	Y			
S4-OFFX45-2024	28710-2024	20242224	1 1/4	31.8	2-12	2 3/8	60	1.10	27.9	3.98	101.1	6.03	153.1	NS	Y	Y	Y			
S4-OFFX45-2424	28710-2424	20242222	1 1/2	38.1	2-12	2 3/8	60	1.10	27.9	4.13	104.9	6.46	164.0	NS	Y	Y				

C: Crimp Nut (see "Fitting Identification" in Appendix for details)

# O-Ring Face Seal (SAE J1453 ORS/ORFS)

Female | 90° Elbow | Swivel

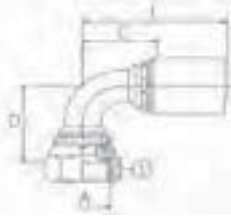

Elbow Type:  
LT=Long Tube  
ST=Short Tube

S=Skive  
NS=Non-Skive  
DG=Dual-Grip™

Descriptive #	Product #	SAP #	Hose Size ID		Thread Size (A)		Hex-1 Wrench Size		Elbow Type	Drop (D)		Cut-Off (C)		Length (L)	Skive Type	SR16SC, SR15N, SR2SN, XR16SC, SCP3, DR15N, DR2SN, ARC16SC, XCP3, LR2SN, DR16SC, ACP3, XCP4					
			in.	mm	in.	mm	in.	mm		in.	mm	in.	mm			SFS	LR2SN	DR16SC	ACP3	XCP4	
B2-OFFX90-0404	14715-0404	20242236	1/4	6.4	9/16-18	11/16	17			1.26	32.0	1.18	30.0	2.16	54.9	NS	Y	Y	Y	Y	Y
B2-OFFX90L-0404	14720-0404	20242254	1/4	6.4	9/16-18	11/16	17	LT		1.81	46.0	1.30	33.0	2.28	57.9	NS	Y	Y	Y	Y	Y
B2-OFFX90S-0404	14725-0404	20242152	1/4	6.4	9/16-18	11/16	17	ST		0.83	21.0	1.10	28.0	2.08	52.9	NS	Y	Y	Y	Y	Y
B2-OFFX90-0406	14715-0406	20242243	1/4	6.4	11/16-16	7/8	22			1.50	38.0	1.46	37.0	2.44	61.9	NS	Y	Y	Y	Y	Y
B2-OFFX90L-0406	14720-0406	20242250	1/4	6.4	11/16-16	7/8	22	LT		2.13	54.0	1.38	35.0	2.36	59.9	NS	Y	Y	Y	Y	Y
B2-OFFX90S-0406	14725-0406	20242151	1/4	6.4	11/16-16	7/8	22	ST		0.91	23.0	1.26	32.0	2.24	56.9	NS	Y	Y	Y	Y	Y
B2-OFFX90S-0604	14725-0604	20591895	3/8	9.5	9/16-18	11/16	17	ST		0.83	21.0	1.10	28.0	2.15	54.6	NS	Y	Y	Y	Y	Y
B2-OFFX90-0606	14715-0606	20242239	3/8	9.5	11/16-16	7/8	22			1.50	38.0	1.65	42.0	2.70	68.6	NS	Y	Y	Y	Y	Y
B2-OFFX90L-0606	14720-0606	20241694	3/8	9.5	11/16-16	7/8	22	LT		2.13	54.0	1.65	42.0	2.70	68.6	NS	Y	Y	Y	Y	Y
B2-OFFX90S-0606	14725-0606	20242158	3/8	9.5	11/16-16	7/8	22	ST		0.98	25.0	1.65	42.0	2.70	68.6	NS	Y	Y	Y	Y	Y
B2-OFFX90-0608	14715-0608	20242252	3/8	9.5	13/16-16	15/16	24			1.61	41.0	1.73	44.0	2.78	70.6	NS	Y	Y	Y	Y	Y
B2-OFFX90L-0608	14720-0608	20241705	3/8	9.5	13/16-16	15/16	24	LT		2.52	64.0	1.85	47.0	2.90	73.6	NS	Y	Y	Y	Y	Y
B2-OFFX90S-0608	14725-0608	20242160	3/8	9.5	13/16-16	15/16	24	ST		1.14	29.0	1.65	42.0	2.70	68.6	NS	Y	Y	Y	Y	Y
B2-OFFX90S-0806	14725-0806	20441217	1/2	12.7	11/16-16	7/8	22	ST		0.98	25.0	1.65	42.0	2.90	73.7	NS	Y	Y	Y	Y	Y
B2-OFFX90-0808C	14715-0808	20241704	1/2	12.7	13/16-16	15/16	24			1.65	42.0	1.38	35.0	2.63	66.7	NS	Y	Y	Y	Y	Y
B2-OFFX90L-0808C	14720-0808	20242216	1/2	12.7	13/16-16	15/16	24	LT		2.52	64.0	1.50	38.0	2.74	69.7	NS	Y	Y	Y	Y	Y
B2-OFFX90S-0808C	14725-0808	20242226	1/2	12.7	13/16-16	15/16	24	ST		1.14	29.0	1.58	40.0	2.82	71.7	NS	Y	Y	Y	Y	Y
B2-OFFX90-0810	14715-0810	20241703	1/2	12.7	1-14	1 3/16	30			1.85	47.0	1.89	48.0	3.14	79.7	NS	Y	Y	Y	Y	Y
B2-OFFX90L-0810	14720-0810	20242214	1/2	12.7	1-14	1 3/16	30	LT		2.76	70.1	1.81	46.0	3.06	77.6	NS	Y	Y	Y	Y	Y
B2-OFFX90S-0810	14725-0810	20242249	1/2	12.7	1-14	1 3/16	30	ST		1.28	32.5	1.81	46.0	3.06	77.6	NS	Y	Y	Y	Y	Y
B2-OFFX90S-0812	14725-0812	20293220	1/2	12.7	1 3/16-12	1 7/16	36	ST		2.01	51.1	2.19	55.6	3.44	87.3	NS	Y	Y	Y	Y	Y
B2-OFFX90-1010	14715-1010	20242242	5/8	15.9	1-14	1 3/16	30			1.73	44.0	2.17	55.0	3.52	89.5	NS	Y	Y	Y	Y	Y
B2-OFFX90L-1010	14720-1010	20241696	5/8	15.9	1-14	1 3/16	30	LT		2.77	70.2	2.17	55.0	3.52	89.5	NS	Y	Y	Y	Y	Y
B2-OFFX90S-1010	14725-1010	20242162	5/8	15.9	1-14	1 3/16	30	ST		1.28	32.5	2.05	52.0	3.40	86.5	NS	Y	Y	Y	Y	Y
B2-OFFX90S-1012	14725-1012	20242161	5/8	15.9	1 3/16-12	1 7/16	36	ST		1.93	49.0	2.17	55.1	3.53	89.6	NS	Y	Y	Y	Y	Y
B2-OFFX90S-1210	14725-1210	20242167	3/4	19.0	1-14	1 3/16	30	ST		1.54	39.1	1.75	44.5	3.30	83.9	NS	Y	Y	Y	Y	Y
B2-OFFX90-1212	14715-1212	20242237	3/4	19.0	1 3/16-12	1 7/16	36			2.28	58.0	2.44	62.0	3.99	101.4	NS	Y	Y	Y	Y	Y
B2-OFFX90L-1212	14720-1212	20242255	3/4	19.0	1 3/16-12	1 7/16	36	LT		3.78	96.0	2.44	62.0	3.99	101.4	NS	Y	Y	Y	Y	Y
B2-OFFX90S-1212	14725-1212	20242153	3/4	19.0	1 3/16-12	1 7/16	36	ST		2.01	51.0	2.40	61.0	3.96	100.5	NS	Y	Y	Y	Y	Y
B2-OFFX90S-1216	14725-1216	20242155	3/4	19.0	1 7/16-12	1 1/2	41	ST		2.80	71.1	2.60	66.0	4.15	105.5	NS	Y	Y	Y	Y	Y
B2-OFFX90S-1612	14725-1612	20441218	1	25.4	1 3/16-12	1 7/16	36	ST		2.01	51.0	2.43	61.7	4.20	106.8	NS	Y	Y	Y	Y	Y
B2-OFFX90-1616	14715-1616	20241698	1	25.4	1 7/16-12	1 1/2	41			2.60	66.0	3.27	83.0	5.04	128.1	NS	Y	Y	Y	Y	Y
B2-OFFX90L-1616	14720-1616	20242202	1	25.4	1 7/16-12	1 1/2	41	LT		4.49	114.0	3.27	83.0	5.04	128.1	NS	Y	Y	Y	Y	Y
B2-OFFX90S-1616	14725-1616	20242244	1	25.4	1 7/16-12	1 1/2	41	ST		2.28	58.0	3.27	83.0	5.04	128.1	NS	Y	Y	Y	Y	Y
B2-OFFX90-1620	14715-1620	20242253	1	25.4	1 11/16-12	2	50			3.07	78.0	3.27	83.0	5.04	128.1	NS	Y	Y	Y	Y	Y
B2-OFFX90S-1620	14725-1620	20242235	1	25.4	1 11/16-12	2	50	ST		2.52	64.0	3.27	83.0	5.04	128.1	NS	Y	Y	Y	Y	Y

C: Crimp Nut (see "Fitting Identification" in Appendix for details)

Continued on next page



# O-Ring Face Seal (SAE J1453 ORS/ORFS)

Female | 90° Elbow | Swivel Continued

Descriptive #	Product #	SAP #	Hose Size ID		Thread Size (A)		Hex-1 Wrench Size		Elbow Type	Drop (D)		Cut-Off (C)		Length (L)		Skive Type	SR16SC, SR15N, SR25N, XR16SC, SCP3, DR15N, DR25N, ARC16SC, XCP3, LR25N, DR16SC, ACP3, XCP4				
			in.	mm	in.	mm	in.	mm		in.	mm	in.	mm	in.	mm		SFS	LR25N	DR16SC	ACP3	XCP4
S4-OFFX90-2020	28715-2020	20241702	1/4	31.8	1 11/16-12	2	50			3.07	78.0	3.82	97.0	5.87	149.0	NS	Y	Y	Y		
S4-OFFX90L-2020	28720-2020	20242212	1/4	31.8	1 11/16-12	2	50	LT		5.08	129.0	3.82	97.0	5.87	149.0	NS	Y	Y	Y		
S4-OFFX90S-2020	28725-2020	20242247	1/4	31.8	1 11/16-12	2	50	ST		2.68	68.1	3.74	95.0	5.79	147.0	NS	Y	Y	Y		
S4-OFFX90L-2024	28720-2024	20242213	1/4	31.8	2-12	2%	60	LT		5.55	141.0	4.02	102.1	6.07	154.1	NS	Y	Y	Y		
S4-OFFX90S-2024	28725-2024	20242248	1/4	31.8	2-12	2%	60	ST		2.72	69.1	4.02	102.1	6.07	154.1	NS	Y	Y	Y		
S4-OFFX90-2424	28715-2424	20241701	1/2	38.1	2-12	2%	60			3.43	87.1	4.25	108.0	6.58	167.1	NS	Y	Y			
S4-OFFX90L-2424	28720-2424	20441321	1/2	38.1	2-12	2%	60	LT		5.55	141.0	4.37	111.0	6.70	170.1	NS	Y	Y			
S4-OFFX90S-2424	28725-2424	20242246	1/2	38.1	2-12	2%	60	ST		3.07	78.0	4.02	102.1	6.35	161.2	NS	Y	Y			

# O-Ring Face Seal (SAE J1453 ORS/ORFS)

Male

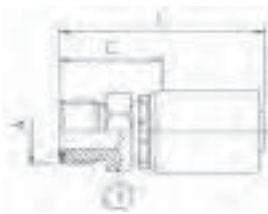

S=Skive  
NS=Non-Skive  
DG=Dual-Grip™

Descriptive #	Product #	SAP #	Hose Size ID		Thread Size (A)		Hex-1 Wrench Size		Cut-Off (C)	Length (L)		Skive Type	SR16SC, SR15N, SR25N, XR16SC, SCP3, DR15N, DR25N, ARC16SC, XCP3, LR25N, DR16SC, ACP3, XCP4						
			in.	mm	in.	mm	in.	mm		in.	mm		SFS	LR25N	DR16SC	ACP3	XCP4		
B2-OFM-0404	14730-0404	20242187	1/4	6.4	9/16-18	11/16	17	1.00	25.4	1.98	50.3	NS	Y	Y	Y	Y	Y		
B2-OFM-0406	14730-0406	20441219	1/4	6.4	11/16-16	3/4	19	0.96	24.3	1.94	49.1	NS	Y	Y	Y	Y	Y		
B2-OFM-0606	14730-0606	20242181	3/8	9.5	11/16-16	3/4	19	1.05	26.7	2.10	53.4	NS	Y	Y	Y	Y	Y		
B2-OFM-0608	14730-0608	20242183	3/8	9.5	13/16-16	7/8	22	1.05	26.6	2.10	53.2	NS	Y	Y	Y	Y	Y		
B2-OFM-0808	14730-0808	20242174	1/2	12.7	13/16-16	7/8	22	1.19	30.3	2.44	62.0	NS	Y	Y	Y	Y	Y		
B2-OFM-0810	14730-0810	20242173	1/2	12.7	1-14	1 1/16	27	1.21	30.7	2.46	62.4	NS	Y	Y	Y	Y	Y		
B2-OFM-0812	14730-0812	20242172	1/2	12.7	1 3/16-12	1 1/4	32	1.34	34.0	2.59	65.7	NS	Y	Y	Y	Y	Y		
B2-OFM-1010	14730-1010	20242186	5/8	15.9	1-14	1 1/16	27	1.22	30.9	2.57	65.3	NS	Y	Y	Y	Y	Y		
B2-OFM-1012	14730-1012	20242185	5/8	15.9	1 3/16-12	1 1/4	32	1.34	34.1	2.70	68.6	NS	Y	Y	Y	Y	Y		
B2-OFM-1212	14730-1212	20242177	3/4	19.0	1 3/16-12	1 1/4	32	1.36	34.6	2.92	74.1	NS	Y	Y	Y	Y	Y		
B2-OFM-1216	14730-1216	20242179	3/4	19.0	1 7/16-12	1 3/8	41	1.55	39.3	3.10	78.8	NS	Y	Y	Y	Y	Y		
B2-OFM-1616	14730-1616	20242194	1	25.4	1 7/16-12	1 1/2	38	1.47	37.4	3.25	82.5	NS	Y	Y	Y	Y	Y		
S4-OFM-2020	28730-2020	20242171	1/4	31.8	1 11/16-12	1 13/16	46	1.64	41.7	3.69	93.7	NS	Y	Y	Y				

# O-Ring Boss Straight Thread (SAE J514)

Male

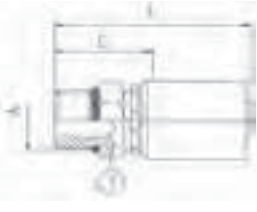

S=Skive  
NS=Non-Skive  
DG=Dual-Grip™

Descriptive #	Product #	SAP #	Hose Size ID		Thread Size (A)		Hex-1 Wrench Size		Cut-Off (C)		Length (L)		Skive Type	SR1SN, DR1SN, SFS	SR2SN, DR2SN, LR2SN	SR16SC, XR16SC, ARC16SC, DR16SC	SCP3, XCP3, ACP3	XCP4
			in.	mm	in.	mm	in.	mm	in.	mm	in.	mm						
B2-OBM-0404	14670-0404	20242133	1/4	6.4	7/16-20	9/16	14	0.88	22.3	1.86	47.2	NS	Y	Y	Y	Y	Y	
B2-OBM-0405	14670-0405	20242132	1/4	6.4	1/2-20	5/8	16	0.88	22.3	1.86	47.2	NS	Y	Y	Y	Y	Y	
B2-OBM-0406	14670-0406	20242129	1/4	6.4	9/16-18	11/16	17	0.88	22.2	1.86	47.1	NS	Y	Y	Y	Y	Y	
B2-OBM-0408	14670-0408	20297678	1/4	6.4	3/4-16	7/8	22	0.98	24.9	1.96	49.8	NS	Y	Y	Y	Y	Y	
B2-OBM-0606	14670-0606	20242122	3/8	9.5	9/16-18	3/4	19	0.94	23.7	1.98	50.4	NS	Y	Y	Y	Y	Y	
B2-OBM-0608	14670-0608	20242121	3/8	9.5	3/4-16	7/8	22	0.73	18.6	2.04	51.7	NS	Y	Y	Y	Y	Y	
B2-OBM-0610	14670-0610	20242117	3/8	9.5	7/8-14	1 1/16	27	1.08	27.4	2.13	54.1	NS	Y	Y	Y	Y	Y	
B2-OBM-0808	14670-0808	20242134	1/2	12.7	3/4-16	7/8	22	1.01	25.6	2.26	57.3	NS	Y	Y	Y	Y	Y	
B2-OBM-0808S	14670-0808S	20424923	1/2	12.7	3/4-16			1.01	25.6	2.26	57.3	NS	Y	Y	Y	Y	Y	
B2-OBM-0810	14670-0810	20242131	1/2	12.7	7/8-14	1 1/16	27	1.10	27.9	2.35	59.6	NS	Y	Y	Y	Y	Y	
B2-OBM-0812	14670-0812	20242128	1/2	12.7	1 1/16-12	1 1/4	32	1.26	32.1	2.51	63.8	NS	Y	Y	Y	Y	Y	
B2-OBM-1008	14670-1008	20293194	5/8	15.9	3/4-16	15/16	24	1.04	26.4	2.40	60.8	NS	Y	Y	Y	Y	Y	
B2-OBM-1010	14670-1010	20293195	5/8	15.9	7/8-14	15/16	24	1.10	27.9	2.46	62.4	NS	Y	Y	Y	Y	Y	
B2-OBM-1012	14670-1012	20242123	5/8	15.9	1 1/16-12	1 1/4	32	1.27	32.2	2.63	66.7	NS	Y	Y	Y	Y	Y	
B2-OBM-1210	14670-1210	20242120	3/4	19.0	7/8-14	1 1/16	27	1.13	28.6	2.68	68.0	NS	Y	Y	Y	Y	Y	
B2-OBM-1212	14670-1212	20242126	3/4	19.0	1 1/16-12	1 1/4	32	1.29	32.7	2.84	72.2	NS	Y	Y	Y	Y	Y	
B2-OBM-1216	14670-1216	20242118	3/4	19.0	1 5/16-12	1 1/2	38	1.37	34.8	2.92	74.2	NS	Y	Y	Y	Y	Y	
B2-OBM-1616	14670-1616	20242127	1	25.4	1 5/16-12	1 1/2	38	1.38	35.0	3.15	80.1	NS	Y	Y	Y	Y	Y	
S4-OBM-2020	28670-2020	20293258	1 1/4	31.8	1 5/8-12	1 13/16	46	1.55	39.3	3.59	91.3	NS	Y	Y	Y			
S4-OBM-2424	28670-2424	20307206	1 1/2	38.1	1 7/8-12			1.60	40.5	3.92	99.7	NS	Y	Y				

## O-Ring Boss Straight Thread (SAE J514)

Male | Swivel

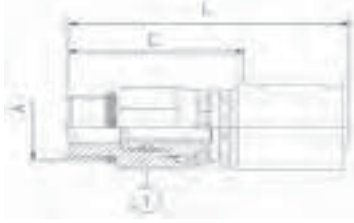

S=Skive  
NS=Non-Skive  
DG=Dual-Grip™

Descriptive #	Product #	SAP #	Hose Size ID		Thread Size (A)		Hex-1 Wrench Size		Cut-Off (C)		Length (L)		Skive Type	SR1SN, DR1SN, SFS	SR2SN, DR2SN, LR2SN	SR16SC, XR16SC, ARC16SC, DR16SC	SCP3, XCP3, ACP3	XCP4
			in.	mm	in.	mm	in.	mm	in.	mm	in.	mm						
B2-OBMX-0404	14680-0404	20293196	1/4	6.4	7/16-20	11/16	17	1.30	32.9	2.28	57.8	NS	Y	Y	Y	Y	Y	
B2-OBMX-0406	14680-0406	20441229	1/4	6.4	9/16-18	7/8	22	1.69	43.0	2.67	67.9	NS	Y	Y	Y	Y	Y	
B2-OBMX-0606	14680-0606	20293197	3/8	9.5	9/16-18	7/8	22	1.61	40.9	2.66	67.5	NS	Y	Y	Y	Y	Y	
B2-OBMX-0608	14680-0608	20293198	3/8	9.5	3/4-16	1	25	1.73	44.0	2.78	70.6	NS	Y	Y	Y	Y	Y	
B2-OBMX-0808	14680-0808	20293199	1/2	12.7	3/4-16	1	25	1.68	42.7	2.93	74.4	NS	Y	Y	Y	Y	Y	
B2-OBMX-0810	14680-0810	20293200	1/2	12.7	7/8-14	1	25	1.69	42.9	2.94	74.6	NS	Y	Y	Y	Y	Y	
B2-OBMX-1212	14680-1212	20293201	3/4	19.0	1 1/16-12	1 1/4	32	1.97	50.0	3.52	89.4	NS	Y	Y	Y	Y	Y	

## O-Ring Boss Straight Thread (SAE J514) Male | 90° Elbow (Block) | Swivel



S=Skive  
NS=Non-Skive  
DG=Dual-Grip™

Descriptive #	Product #	SAP #	Hose Size ID		Thread Size (A)		Hex-1 Wrench Size		Drop (D)		Cut-Off (C)		Length (L)		Skive Type	SR1SN, DR1SN, SFS	SR2SN, DR2SN, LR2SN	SR16SC, XR16SC, ARC16SC, DR16SC	SCP3, XCP3, ACP3	XCP4
			in.	mm	in.	mm	in.	mm	in.	mm	in.	mm	in.	mm						
B2-OBMX90B-0405	14685-0405	20293202	1/4	6.4	1/2-20	11/16	17	1.50	38.1	0.71	18.1	1.69	43.0	NS	Y	Y	Y	Y	Y	
B2-OBMX90B-0406	14685-0406	20441270	1/4	6.4	9/16-18	7/8	22	1.74	44.3	0.80	20.3	1.78	45.2	NS	Y	Y	Y	Y	Y	
B2-OBMX90B-0606	14685-0606	20293203	3/8	9.5	9/16-18	7/8	22	1.74	44.3	0.92	23.3	1.97	50.0	NS	Y	Y	Y	Y	Y	
B2-OBMX90B-0608	14685-0608	20293204	3/8	9.5	3/4-16	1	25	2.17	55	1.13	28.8	2.18	55.4	NS	Y	Y	Y	Y	Y	
B2-OBMX90B-0808	14685-0808	20293205	1/2	12.7	3/4-16	1	25	2.17	55	1.16	29.4	2.41	61.1	NS	Y	Y	Y	Y	Y	
B2-OBMX90B-0810	14685-0810	20293206	1/2	12.7	7/8-14	1	25	2.17	55.2	1.16	29.4	2.41	61.1	NS	Y	Y	Y	Y	Y	
B2-OBMX90B-1012	14685-1012	20294829	5/8	15.9	1 1/16-12	1 1/4	32	2.58	65.6	1.23	31.3	2.59	65.8	NS	Y	Y	Y	Y	Y	
B2-OBMX90B-1212	14685-1212	20293207	3/4	19.0	1 1/16-12	1 1/4	32	2.58	65.5	1.24	31.5	2.80	71.0	NS	Y	Y	Y	Y	Y	

## Code 61 Flange (SAE J518)



S=Skive  
NS=Non-Skive  
DG=Dual-Grip™

Descriptive #	Product #	SAP #	Hose Size ID		Flange Size	Flange Diameter (A)		Cut-Off (C)		Length (L)		Skive Type	SR1SN, DR1SN, SFS	SR2SN, DR2SN, LR2SN	SR16SC, XR16SC, ARC16SC, DR16SC	SCP3, XCP3, ACP3	XCP4
			in.	mm		in.	mm	in.	mm	in.	mm						
B2-FL-0808	14320-0808	20242908	1/2	12.7	1/2	1.19	30.2	1.61	40.9	2.86	72.6	NS	Y	Y	Y	Y	Y
B2-FL-0812	14320-0812	20242906	1/2	12.7	3/4	1.50	38.1	1.65	41.9	2.90	73.6	NS	Y	Y	Y	Y	Y
B2-FL-1012	14320-1012	20242899	5/8	15.9	3/4	1.50	38.1	1.60	40.7	3.02	76.6	NS	Y	Y	Y	Y	Y
B2-FL-1212	14320-1212	20242901	3/4	19.0	3/4	1.50	38.1	1.67	42.4	3.22	81.9	NS	Y	Y	Y	Y	Y
B2-FL-1216	14320-1216	20242903	3/4	19.0	1	1.75	44.5	1.99	50.5	3.54	90.0	NS	Y	Y	Y	Y	Y
B2-FL-1616	14320-1616	20242879	1	25.4	1	1.75	44.5	2.02	51.3	3.80	96.4	NS	Y	Y	Y	Y	Y
B2-FL-1620	14320-1620	20242902	1	25.4	1 1/4	2.00	50.8	2.12	53.8	3.90	98.9	NS	Y	Y	Y	Y	Y
S4-FL-2020	28320-2020	20242909	1 1/4	31.8	1 1/4	2.00	50.8	2.19	55.6	4.24	107.6	NS	Y	Y	Y	Y	Y
S4-FL-2024	28320-2024	20242910	1 1/4	31.8	1 1/2	2.37	60.3	2.30	58.4	4.35	110.4	NS	Y	Y	Y	Y	Y
S4-FL-2424	28320-2424	20242886	1 1/2	38.1	1 1/2	2.37	60.3	2.31	58.7	4.64	117.8	NS	Y	Y	Y	Y	Y
S4-FL-2432	28320-2432	20242911	1 1/2	38.1	2	2.81	71.4	2.76	70.1	5.09	129.2	NS	Y	Y	Y	Y	Y
S4-FL-3232	28320-3232	20242895	2	50.8	2	2.81	71.4	2.76	70.1	5.59	142.1	NS	Y	Y	Y	Y	Y

## Code 61 Flange (SAE J518)

22.5° Elbow

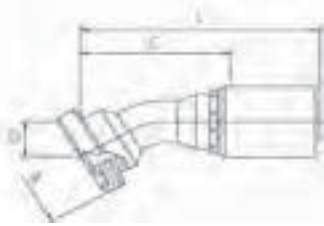

S=Skive  
NS=Non-Skive  
DG=Dual-Grip™

Descriptive #	Product #	SAP #	Hose Size ID		Flange Size	Flange Diameter (A)		Drop (D)		Cut-Off (C)		Length (L)		Skive Type	SR1SN, DR1SN, SFS	SR2SN, DR2SN, LR2SN	SR16SC, XR16SC, ARC16SC, DR16SC	SCP3, XCP3, ACP3	XCP4
			in.	mm		in.	mm	in.	mm	in.	mm	in.	mm						
B2-FL22-1616	14330-1616	20242939	1	25.4	1	1.75	44.5	0.47	11.9	3.66	93.0	5.44	138.0	NS	Y	Y	Y	Y	Y
S4-FL22-2020	28330-2020	20242928	1 1/4	31.8	1 1/4	2.00	50.8	0.63	16.0	4.49	114.0	6.54	166.0	NS	Y	Y	Y	Y	Y
S4-FL22-2024	28330-2024	20293266	1 1/4	31.8	1 1/2	2.37	60.3	0.81	20.6	4.53	115.1	6.58	167.0	NS	Y	Y	Y	Y	Y
S4-FL22-2424	28330-2424	20242923	1 1/2	38.1	1 1/2	2.37	60.3	0.65	16.5	5.16	131.1	7.49	190.2	NS	Y	Y	Y	Y	Y
S4-FL22-3232	28330-3232	20293267	2	50.8	2	2.81	71.4	0.87	22.1	6.02	152.9	8.85	224.9	NS	Y	Y	Y	Y	Y

## Code 61 Flange (SAE J518)

30° Elbow

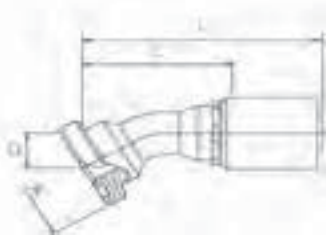

S=Skive  
NS=Non-Skive  
DG=Dual-Grip™

Descriptive #	Product #	SAP #	Hose Size ID		Flange Size	Flange Diameter (A)		Drop (D)		Cut-Off (C)		Length (L)		Skive Type	SR1SN,	SR2SN,	SR16SC,	SCP3,
			in.	mm		in.	mm	in.	mm	in.	mm	in.	mm		in.	mm	SFS	LR2SN
B2-FL30-1616	14335-1616	20242927	1	25.4	1	1.75	44.5	0.83	21.1	3.54	89.9	5.32	135.0	NS	Y	Y	Y	Y
S4-FL30-2020	28335-2020	20242922	1¼	31.8	1¼	2.00	50.8	0.98	24.9	4.02	102.1	6.07	154.1	NS	Y	Y	Y	
S4-FL30-2024	28335-2024	20242913	1¼	31.8	1½	2.37	60.3	1.06	26.9	4.41	112.0	6.46	164.0	NS	Y	Y	Y	
S4-FL30-2424	28335-2424	20242924	1½	38.1	1½	2.37	60.3	0.91	23.1	5.35	135.9	7.68	195.0	NS	Y	Y		
S4-FL30-2432	28335-2432	20293269	1½	38.1	2	2.81	71.4	1.44	36.6	5.91	150.1	8.24	209.2	NS	Y	Y		
S4-FL30-3232	28335-3232	20293270	2	50.8	2	2.81	71.4	1.18	30.0	5.87	149.1	8.70	221.1	NS	Y	Y		

## Code 61 Flange (SAE J518)

45° Elbow

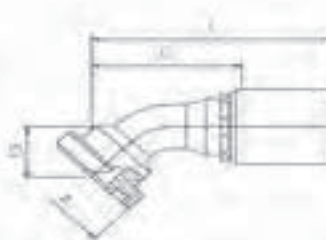

S=Skive  
NS=Non-Skive  
DG=Dual-Grip™

Descriptive #	Product #	SAP #	Hose Size ID		Flange Size	Flange Diameter (A)		Drop (D)		Cut-Off (C)		Length (L)		Skive Type	SR1SN,	SR2SN,	SR16SC,	SCP3,
			in.	mm		in.	mm	in.	mm	in.	mm	in.	mm		in.	mm	SFS	LR2SN
B2-FL45-0808	14340-0808	20242949	1/2	12.7	1/2	1.19	30.2	0.87	22.1	2.09	53.1	3.34	84.8	NS	Y	Y	Y	Y
B2-FL45-0812	14340-0812	20242947	1/2	12.7	3/4	1.50	38.1	1.02	25.9	2.36	59.9	3.61	91.6	NS	Y	Y	Y	Y
B2-FL45-1212	14340-1212	20242942	3/4	19.0	3/4	1.50	38.1	1.26	32.0	2.91	73.9	4.46	113.4	NS	Y	Y	Y	Y
B2-FL45-1216	14340-1216	20242944	3/4	19.0	1	1.75	44.5	1.14	29.0	3.07	78.0	4.62	117.4	NS	Y	Y	Y	Y
B2-FL45-1616	14340-1616	20242919	1	25.4	1	1.75	44.5	1.32	33.5	3.27	83.1	5.05	128.1	NS	Y	Y	Y	Y
B2-FL45-1620	14340-1620	20242917	1	25.4	1¼	2.00	50.8	1.42	36.1	3.23	82.0	5.01	127.1	NS	Y	Y	Y	Y
S4-FL45-2020	28340-2020	20242934	1¼	31.8	1¼	2.00	50.8	1.48	37.6	3.74	95.0	5.79	147.0	NS	Y	Y	Y	
S4-FL45-2024	28340-2024	20242921	1¼	31.8	1½	2.37	60.3	1.57	39.9	4.09	103.9	6.14	155.9	NS	Y	Y	Y	
S4-FL45-2424	28340-2424	20242915	1½	38.1	1½	2.37	60.3	1.89	48.0	4.61	117.1	6.94	176.2	NS	Y	Y		
S4-FL45-2432	28340-2432	20242914	1½	38.1	2	2.81	71.4	2.19	55.6	5.35	135.9	7.68	195.1	NS	Y	Y		
S4-FL45-3232	28340-3232	20242945	2	50.8	2	2.81	71.4	1.87	47.5	5.55	141.0	8.38	213.0	NS	Y	Y		

# Code 61 Flange (SAE J518)

60° Elbow

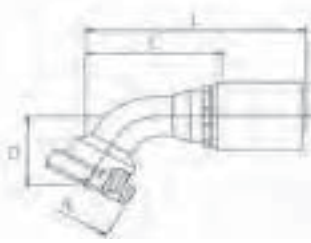

S=Skive  
NS=Non-Skive  
DG=Dual-Grip™

Descriptive #	Product #	SAP #	Hose Size ID		Flange Size	Flange Diameter (A)		Drop (D)		Cut-Off (C)		Length (L)		Skive Type	SR1SN, DR1SN, SFS	SR2SN, DR2SN, LR2SN	SR16SC, XR16SC, ARC16SC, DR16SC	SCP3, XCP3, ACP3	XCP4		
			in.	mm		in.	mm	in.	mm	in.	mm	in.	mm							in.	mm
			B2-FL60-1212	14345-1212		20242938	3/4	19.0	3/4	1.50	38.1	1.46	37.1							3.39	86.1
B2-FL60-1216	14345-1216	20242936	3/4	19.0	1	1.75	44.5	1.73	43.9	4.02	102.1	5.66	143.8	NS	Y	Y	Y	Y	Y		
B2-FL60-1616	14345-1616	20293255	1	25.4	1	1.75	44.5	1.85	47.0	3.98	101.1	5.76	146.2	NS	Y	Y	Y	Y	Y		
S4-FL60-2020	28345-2020	20242937	1¼	31.8	1¼	2.00	50.8	2.22	56.4	5.10	129.5	7.15	181.5	NS	Y	Y	Y				
S4-FL60-2024	28345-2024	20293271	1¼	31.8	1½	2.37	60.3	2.22	56.5	5.98	151.9	8.31	211.0	NS	Y	Y	Y				
S4-FL60-2424	28345-2424	20293272	1½	38.1	1½	2.37	60.3	2.28	57.9	5.31	134.9	7.36	186.8	NS	Y	Y					
S4-FL60-2432	28345-2432	20293273	1½	38.1	2	2.81	71.4	3.05	77.5	6.52	165.6	8.85	224.7	NS	Y	Y					
S4-FL60-3232	28345-3232	20293274	2	50.8	2	2.81	71.4	3.62	91.9	6.81	173.0	9.64	245.0	NS	Y	Y					

# Code 61 Flange (SAE J518)

67° Elbow

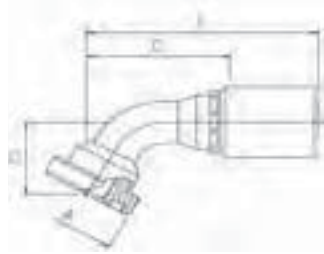

S=Skive  
NS=Non-Skive  
DG=Dual-Grip™

Descriptive #	Product #	SAP #	Hose Size ID		Flange Size	Flange Diameter (A)		Drop (D)		Cut-Off (C)		Length (L)		Skive Type	SR1SN, DR1SN, SFS	SR2SN, DR2SN, LR2SN	SR16SC, XR16SC, ARC16SC, DR16SC	SCP3, XCP3, ACP3	XCP4
			in.	mm		in.	mm	in.	mm	in.	mm	in.	mm						
			B2-FL67-1616	14347-1616		20293256	1	25.4	1	1.75	44.5	1.95	49.5						
S4-FL67-2020	28347-2020	20293278	1¼	31.8	1¼	2.00	50.8	2.46	62.5	4.72	119.9	6.77	171.9	NS	Y	Y	Y		
S4-FL67-2024	28347-2024	20293279	1¼	31.8	1½	2.37	60.3	2.58	65.5	4.78	121.5	6.83	173.5	NS	Y	Y	Y		
S4-FL67-2424	28347-2424	20293280	1½	38.1	1½	2.37	60.3	2.58	65.5	5.33	135.4	7.66	194.5	NS	Y	Y			
S4-FL67-2432	28347-2432	20293281	1½	38.1	2	2.81	71.4	3.46	87.9	5.55	141.0	7.88	200.1	NS	Y	Y			
S4-FL67-3232	28347-3232	20293282	2	50.8	2	2.81	71.4	3.76	95.5	7.05	179.1	9.88	251.1	NS	Y	Y			

## Code 61 Flange (SAE J518)

90° Elbow

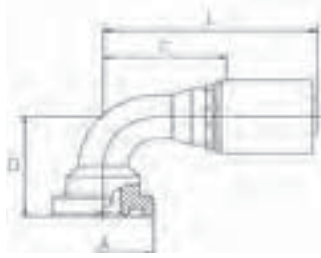

S=Skive  
NS=Non-Skive  
DG=Dual-Grip™

Descriptive #	Product #	SAP #	Hose Size ID		Flange Size	Flange Diameter (A)		Drop (D)		Cut-Off (C)		Length (L)		Skive Type	SR1SN,	SR2SN,	SR16SC,	SCP3,	XCP4
			in.	mm		in.	mm	in.	mm	in.	mm	in.	mm		in.	mm	DR1SN, SFS	DR2SN, LR2SN	
B2-FL90-0808	14350-0808	20242888	1/2	12.7	1/2	1.19	30.2	1.65	41.9	1.81	46.0	3.06	77.6	NS	Y	Y	Y	Y	Y
B2-FL90-0812	14350-0812	20242877	1/2	12.7	3/4	1.50	38.1	2.01	51.1	1.77	45.0	3.02	76.6	NS	Y	Y	Y	Y	Y
B2-FL90-1212	14350-1212	20242881	3/4	19.0	3/4	1.50	38.1	2.36	59.9	2.28	57.9	3.83	97.4	NS	Y	Y	Y	Y	Y
B2-FL90-1216	14350-1216	20242883	3/4	19.0	1	1.75	44.5	2.54	64.5	2.60	66.0	4.15	105.5	NS	Y	Y	Y	Y	Y
B2-FL90-1616	14350-1616	20242930	1	25.4	1	1.75	44.5	2.64	67.1	2.80	71.1	4.58	116.2	NS	Y	Y	Y	Y	Y
B2-FL90-1620	14350-1620	20242893	1	25.4	1 1/4	2.00	50.8	2.80	71.1	2.91	73.9	4.69	119.0	NS	Y	Y	Y	Y	Y
S4-FL90-2016	28350-2016	20242897	1 1/4	31.8	1	1.75	44.5	2.56	65.0	3.70	94.0	5.75	145.9	NS	Y	Y	Y	Y	Y
S4-FL90-2020	28350-2020	20242931	1 1/4	31.8	1 1/4	2.00	50.8	3.31	84.1	3.46	87.9	5.51	139.9	NS	Y	Y	Y	Y	Y
S4-FL90-2024	28350-2024	20242889	1 1/4	31.8	1 1/2	2.37	60.3	3.44	87.4	3.58	90.9	5.63	142.9	NS	Y	Y	Y	Y	Y
S4-FL90-2424	28350-2424	20242891	1 1/2	38.1	1 1/2	2.37	60.3	3.58	90.9	4.13	104.9	6.46	164.0	NS	Y	Y	Y	Y	Y
S4-FL90-2432	28350-2432	20242890	1 1/2	38.1	2	2.81	71.4	4.53	115.1	4.13	104.9	6.46	164.0	NS	Y	Y	Y	Y	Y
S4-FL90-3232	28350-3232	20242894	2	50.8	2	2.81	71.4	5.12	130.0	5.08	129.0	7.91	201.0	NS	Y	Y	Y	Y	Y

## Code 62 Flange (SAE J518)

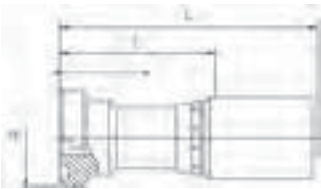

S=Skive  
NS=Non-Skive  
DG=Dual-Grip™

Descriptive #	Product #	SAP #	Hose Size ID		Flange Size	Flange Diameter (A)		Cut-Off (C)		Length (L)		Skive Type	SR1SN,	SR2SN,	SR16SC,	SCP3,	XCP4
			in.	mm		in.	mm	in.	mm	in.	mm		DR1SN, SFS	DR2SN, LR2SN	XR16SC, ARC16SC, DR16SC	ACP3	
B2-FH-1212	14300-1212	20241745	3/4	19.0	3/4	1.63	41.3	2.07	52.6	3.62	92.0	NS	Y	Y	Y	Y	Y
B2-FH-1616	14300-1616	20242954	1	25.4	1	1.87	47.6	2.22	56.4	4.00	101.5	NS	Y	Y	Y	Y	Y
B2-FH-1620	14300-1620	20242951	1	25.4	1 1/4	2.13	54.0	2.48	62.9	4.25	108.0	NS	Y	Y	Y	Y	Y
S4-FH-2016	28300-2016	20441292	1 1/4	31.8	1	1.87	47.6	3.26	82.9	5.31	134.9	NS	Y	Y	Y	Y	Y
S4-FH-2020	28300-2020	20241752	1 1/4	31.8	1 1/4	2.13	54.0	3.27	83.1	5.32	135.0	NS	Y	Y	Y	Y	Y
S4-FH-2024	28300-2024	20241754	1 1/4	31.8	1 1/2	2.50	63.5	2.79	71.0	4.84	122.9	NS	Y	Y	Y	Y	Y
S4-FH-2424	28300-2424	20241751	1 1/2	38.1	1 1/2	2.50	63.5	3.74	95.0	6.07	154.1	NS	Y	Y	Y	Y	Y
S4-FH-2432	28300-2432	20241757	1 1/2	38.1	2	3.13	79.4	2.99	75.9	5.32	135.1	NS	Y	Y	Y	Y	Y
S4-FH-3232	28300-3232	20241759	2	50.8	2	3.13	79.4	2.99	75.9	5.82	147.9	NS	Y	Y	Y	Y	Y

## Code 62 Flange (SAE J518)

22.5° Elbow

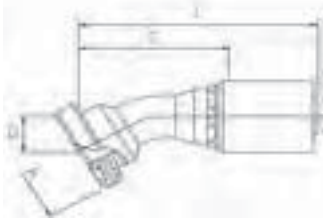

S=Skive  
NS=Non-Skive  
DG=Dual-Grip™

Descriptive #	Product #	SAP #	Hose Size ID		Flange Size	Flange Diameter (A)		Drop (D)		Cut-Off (C)		Length (L)		Skive Type	SR1SN,	SR2SN,	SR16SC,	SCP3,	
			in.	mm		in.	mm	in.	mm	in.	mm	in.	mm		in.	mm	DR1SN, SFS	DR2SN, LR2SN	XR16SC, ARC16SC, DR16SC
S4-FH22-2020	28303-2020	20293291	1/4	31.8	1/4	2.13	54.0	0.69	17.5	4.72	119.9	6.77	171.8	NS	Y	Y	Y		
S4-FH22-2024	28303-2024	20293292	1/4	31.8	1/2	2.50	63.5	0.81	20.6	5.04	128.0	7.09	180.0	NS	Y	Y	Y		

## Code 62 Flange (SAE J518)

30° Elbow



S=Skive  
NS=Non-Skive  
DG=Dual-Grip™

Descriptive #	Product #	SAP #	Hose Size ID		Flange Size	Flange Diameter (A)		Drop (D)		Cut-Off (C)		Length (L)		Skive Type	SR1SN,	SR2SN,	SR16SC,	SCP3,
			in.	mm		in.	mm	in.	mm	in.	mm	in.	mm		in.	mm	DR1SN, SFS	DR2SN, LR2SN
S4-FH30-2020	28305-2020	20293295	1/4	31.8	1/4	2.13	54.0	0.96	24.4	4.61	117.1	6.66	169.0	NS	Y	Y	Y	
S4-FH30-2024	28305-2024	20293296	1/4	31.8	1/2	2.50	63.5	1.12	28.4	4.90	124.5	6.95	176.4	NS	Y	Y	Y	
S4-FH30-2424	28305-2424	20293297	1/2	38.1	1/2	2.50	63.5	1.08	27.4	5.22	132.6	7.55	191.7	NS	Y	Y		
S4-FH30-3232	28305-3232	20293298	2	50.8	2	3.13	79.4	1.44	36.6	6.65	168.9	9.48	240.9	NS	Y	Y		



## Code 62 Flange (SAE J518)

45° Elbow



S=Skive  
NS=Non-Skive  
DG=Dual-Grip™

Descriptive #	Product #	SAP #	Hose Size ID		Flange Size		Flange Diameter (A)		Drop (D)		Cut-Off (C)		Length (L)		Skive Type	SR1SN,	SR2SN,	SR16SC,	SCP3,	SCP3,
			in.	mm	in.	mm	in.	mm	in.	mm	in.	mm	in.	mm		in.	mm	DR1SN, SFS	DR2SN, LR2SN	XR16SC, ARC16SC, DR16SC
B2-FH45-1212	14310-1212	20241791	¾	19.0	¾	1.63	41.3	1.22	31.0	3.31	84.1	4.86	123.5	NS	Y	Y	Y	Y	Y	
B2-FH45-1616	14310-1616	20241775	1	25.4	1	1.87	47.6	1.42	36.1	3.82	97.0	5.60	142.1	NS	Y	Y	Y	Y	Y	
B2-FH45-1620	14310-1620	20241772	1	25.4	1¼	2.13	54.0	1.54	39.1	3.78	96.0	5.56	141.1	NS	Y	Y	Y	Y	Y	
S4-FH45-2020	28310-2020	20241764	1¼	31.8	1¼	2.13	54.0	1.57	39.9	4.29	109.0	6.34	160.9	NS	Y	Y	Y	Y	Y	
S4-FH45-2024	28310-2024	20241765	1¼	31.8	1½	2.50	63.5	1.79	45.5	4.53	115.1	6.58	167.0	NS	Y	Y	Y	Y	Y	
S4-FH45-2424	28310-2424	20241769	1½	38.1	1½	2.50	63.5	1.77	45.0	4.84	122.9	7.17	182.1	NS	Y	Y	Y	Y	Y	
S4-FH45-2432	28310-2432	20241776	1½	38.1	2	3.13	79.4	2.26	57.4	5.24	133.1	7.57	192.2	NS	Y	Y	Y	Y	Y	
S4-FH45-3232	28310-3232	20241767	2	50.8	2	3.13	79.4	2.36	59.9	6.18	157.0	9.01	229.0	NS	Y	Y	Y	Y	Y	

## Code 62 Flange (SAE J518)

60° Elbow

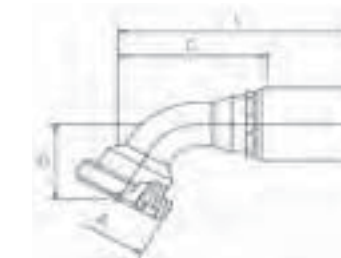

S=Skive  
NS=Non-Skive  
DG=Dual-Grip™

Descriptive #	Product #	SAP #	Hose Size ID		Flange Size		Flange Diameter (A)		Drop (D)		Cut-Off (C)		Length (L)		Skive Type	SR1SN,	SR2SN,	SR16SC,	SCP3,	SCP3,
			in.	mm	in.	mm	in.	mm	in.	mm	in.	mm	in.	mm		in.	mm	DR1SN, SFS	DR2SN, LR2SN	XR16SC, ARC16SC, DR16SC
S4-FH60-2020	28312-2020	20293301	1¼	31.8	1¼	2.13	54.0	2.32	58.9	5.26	133.6	7.31	185.5	NS	Y	Y	Y	Y	Y	
S4-FH60-2024	28312-2024	20293302	1¼	31.8	1½	2.50	63.5	2.48	63.0	5.49	139.4	7.54	191.4	NS	Y	Y	Y	Y	Y	

# Code 62 Flange (SAE J518)

90° Elbow

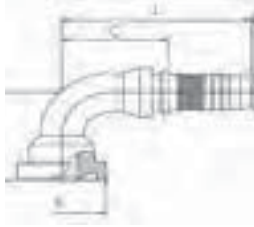

S=Skive  
NS=Non-Skive  
DG=Dual-Grip™

Descriptive #	Product #	SAP #	Hose Size ID		Flange Size	Flange Diameter (A)		Drop (D)		Cut-Off (C)		Length (L)		Skive Type	SR1SN,	SR2SN,	SR16SC,	SCP3,	
			in.	mm		in.	mm	in.	mm	in.	mm	in.	mm		in.	mm	DR1SN, SFS	DR2SN, LR2SN	ARC16SC, DR16SC
B2-FH90-0808	14315-0808	20241744	1/2	12.7	1/2	1.25	31.8	1.81	46.0	1.89	48.0	3.32	84.3	NS	Y	Y	Y	Y	Y
B2-FH90-1212	14315-1212	20241732	3/4	19.0	3/4	1.63	41.3	2.40	61.0	2.48	63.0	4.03	102.4	NS	Y	Y	Y	Y	Y
B2-FH90-1616	14315-1616	20241788	1	25.4	1	1.87	47.6	2.95	74.9	2.91	73.9	4.69	119.0	NS	Y	Y	Y	Y	Y
B2-FH90-1620	14315-1620	20241785	1	25.4	1 1/4	2.13	54.0	3.07	78.0	3.07	78.0	4.85	123.1	NS	Y	Y	Y	Y	Y
S4-FH90-2016	28315-2016	20441315	1 1/4	31.8	1	1.87	47.6	2.83	71.9	3.35	85.1	5.40	137.0	NS	Y	Y	Y	Y	Y
S4-FH90-2020	28315-2020	20241780	1 1/4	31.8	1 1/4	2.13	54.0	3.50	88.9	3.70	94.0	5.75	145.9	NS	Y	Y	Y	Y	Y
S4-FH90-2024	28315-2024	20241781	1 1/4	31.8	1 1/2	2.50	63.5	3.70	94.0	3.86	98.0	5.91	150.0	NS	Y	Y	Y	Y	Y
S4-FH90-2424	28315-2424	20241771	1 1/2	38.1	1 1/2	2.50	63.5	4.13	104.9	3.94	100.1	6.27	159.2	NS	Y	Y	Y	Y	Y
S4-FH90-2432	28315-2432	20241777	1 1/2	38.1	2	3.13	79.4	4.84	122.9	4.53	115.1	6.86	174.2	NS	Y	Y	Y	Y	Y
S4-FH90-3232	28315-3232	20241740	2	50.8	2	3.13	79.4	5.20	132.1	5.63	143.0	8.46	215.0	NS	Y	Y	Y	Y	Y

# Komatsu® Flange

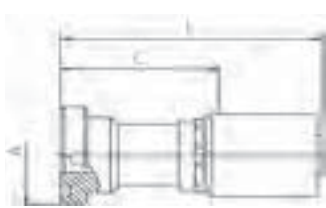

S=Skive  
NS=Non-Skive  
DG=Dual-Grip™

Descriptive #	Product #	SAP #	Hose Size ID		Flange Size	Flange Diameter (A)		Cut-Off (C)		Length (L)		Skive Type	SR1SN,	SR2SN,	SR16SC,	SCP3,	
			in.	mm		in.	mm	in.	mm	in.	mm		DR1SN, SFS	DR2SN, LR2SN	ARC16SC, DR16SC	XCP3, ACP3	XCP4
B2-KF-0810	14530-0810	20293257	1/2	12.7	5/8	1.34	34.0	1.83	46.6	3.08	78.2	NS	Y	Y	Y	Y	Y
B2-KF-1010	14530-1010	20242060	5/8	15.9	5/8	1.34	34.0	1.84	46.8	3.20	81.3	NS	Y	Y	Y	Y	Y

# Komatsu® Flange

45° Elbow

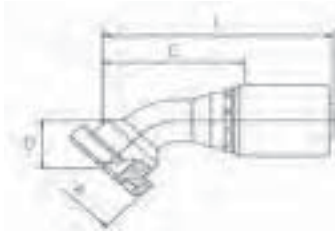

S=Skive  
NS=Non-Skive  
DG=Dual-Grip™

Descriptive #	Product #	SAP #	Hose Size ID		Flange Size	Flange Diameter (A)		Drop (D)		Cut-Off (C)		Length (L)		Skive Type	SR15N, SR25N, DR15N, DR25N		SR16SC, XR16SC, ARC16SC, DR16SC		SCP3, XCP3, ACP3, XCP4	
			in.	mm		in.	mm	in.	mm	in.	mm	in.	mm		SFS	LR2SN	DR16SC	ACP3	XCP4	
B2-KF45-1010	14535-1010	20242061	5/8	15.9	5/8	1.34	34.0	0.98	24.9	2.32	58.9	3.68	93.4	NS	Y	Y	Y	Y	Y	

# Komatsu® Flange

90° Elbow

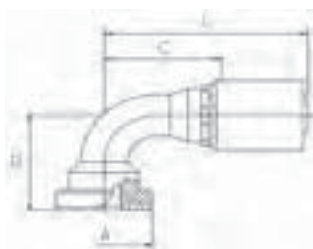

S=Skive  
NS=Non-Skive  
DG=Dual-Grip™

Descriptive #	Product #	SAP #	Hose Size ID		Flange Size	Flange Diameter (A)		Drop (D)		Cut-Off (C)		Length (L)		Skive Type	SR15N, SR25N, DR15N, DR25N		SR16SC, XR16SC, ARC16SC, DR16SC		SCP3, XCP3, ACP3, XCP4	
			in.	mm		in.	mm	in.	mm	in.	mm	in.	mm		SFS	LR2SN	DR16SC	ACP3	XCP4	
B2-KF90-1010	14540-1010	20242062	5/8	15.9	5/8	1.34	34.0	2.01	51.1	1.97	50.0	3.33	84.5	NS	Y	Y	Y	Y	Y	

# BSPF (British Standard Pipe Parallel)

Female | Swivel

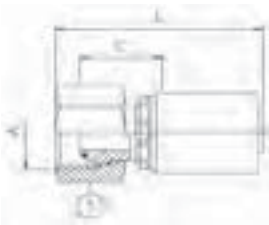

S=Skive  
NS=Non-Skive  
DG=Dual-Grip™

Descriptive #	Product #	SAP #	Hose Size ID		Thread Size (A)	Hex-1 Wrench Size	Cut-Off (C)		Length (L)		Skive Type	SR1SN, DR1SN, SFS	SR2SN, DR2SN, LR2SN	SR16SC, XR16SC, ARC16SC, DR16SC	SCP3, XCP3, ACP3	XCP4
			in.	mm			mm	in.	mm	in.						
B2-BPFX-0404	14105-0404	20242821	1/4	6.4	1/4-19	19	0.93	23.7	1.91	48.6	NS	Y	Y	Y	Y	Y
B2-BPFX-0406	14105-0406	20242820	1/4	6.4	3/8-19	22	1.09	27.6	2.07	52.5	NS	Y	Y	Y	Y	Y
B2-BPFX-0606	14105-0606	20242834	3/8	9.5	3/8-19	22	1.09	27.8	2.14	54.4	NS	Y	Y	Y	Y	Y
B2-BPFX-0608	14105-0608	20242822	3/8	9.5	1/2-14	27	1.20	30.4	2.24	57.0	NS	Y	Y	Y	Y	Y
B2-BPFX-0808	14105-0808	20242826	1/2	12.7	1/2-14	27	1.22	31.0	2.47	62.7	NS	Y	Y	Y	Y	Y
B2-BPFX-0810	14105-0810	20242823	1/2	12.7	5/8-14	27	1.48	37.6	2.73	69.3	NS	Y	Y	Y	Y	Y
B2-BPFX-1010C	14105-1010	20242824	5/8	15.9	5/8-14	27	1.12	28.5	2.48	62.9	NS	Y	Y	Y	Y	Y
B2-BPFX-1012	14105-1012	20242839	5/8	15.9	3/4-14	32	1.49	37.8	2.84	72.2	NS	Y	Y	Y	Y	Y
B2-BPFX-1212C	14105-1212	20242818	3/4	19.0	3/4-14	32	1.17	29.7	2.72	69.1	NS	Y	Y	Y	Y	Y
B2-BPFX-1616C	14105-1616	20242862	1	25.4	1-11	38	1.36	34.4	3.13	79.5	NS	Y	Y	Y	Y	Y
S4-BPFX-2020T	28105-2020	20242842	1 1/4	31.8	1 1/4-11	50	1.69	42.8	3.73	94.8	NS	Y	Y	Y		
S4-BPFX-2424T	28105-2424	20242860	1 1/2	38.1	1 1/2-11	55	1.80	45.8	4.13	105.0	NS	Y	Y			
S4-BPFX-3232T	28105-3232	20242819	2	50.8	2-11	70	1.98	50.2	4.81	122.2	NS	Y	Y			

C: Crimp Nut T: Thrust-Wire Nut (see "Fitting Identification" in Appendix for details)

# BSPF (British Standard Pipe Parallel)

Female | 45° Elbow | Swivel

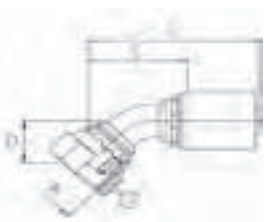

S=Skive  
NS=Non-Skive  
DG=Dual-Grip™

Descriptive #	Product #	SAP #	Hose Size ID		Thread Size (A)	Hex-1 Wrench Size	Drop (D)		Cut-Off (C)		Length (L)		Skive Type	SR1SN, DR1SN, SFS	SR2SN, DR2SN, LR2SN	SR16SC, XR16SC, ARC16SC, DR16SC	SCP3, XCP3, ACP3	XCP4
			in.	mm			mm	in.	mm	in.	mm	in.						
B2-BPFX45-0404 <sup>S</sup>	14115-0404	20242851	1/4	6.4	1/4-19	19	0.59	15.0	1.81	46.0	2.79	70.9	NS	Y	Y	Y	Y	Y
B2-BPFX45-0606 <sup>S</sup>	14115-0606	20242847	3/8	9.5	3/8-19	22	0.81	20.6	1.97	50.0	3.02	76.7	NS	Y	Y	Y	Y	Y
B2-BPFX45-0808 <sup>S</sup>	14115-0808	20242853	1/2	12.7	1/2-14	27	0.83	21.1	2.17	55.1	3.42	86.8	NS	Y	Y	Y	Y	Y
B2-BPFX45-1010	14115-1010	20242846	5/8	15.9	5/8-14	27	0.85	21.6	2.52	64.0	3.88	98.5	NS	Y	Y	Y	Y	Y
B2-BPFX45-1212	14115-1212	20242849	3/4	19.0	3/4-14	32	1.10	27.9	2.76	70.1	4.31	109.6	NS	Y	Y	Y	Y	Y
B2-BPFX45-1616	14115-1616	20242850	1	25.4	1-11	38	1.34	34.0	3.31	84.1	5.09	129.2	NS	Y	Y	Y	Y	Y
S4-BPFX45-2020T	28115-2020	20242854	1 1/4	31.8	1 1/4-11	50	1.57	39.9	3.98	101.1	6.03	153.1	NS	Y	Y	Y		
S4-BPFX45-2424T	28115-2424	20242855	1 1/2	38.1	1 1/2-11	55	1.81	46.0	4.57	116.1	6.90	175.2	NS	Y	Y			
S4-BPFX45-3232T	28115-3232	20242841	2	50.8	2-11	70	2.36	59.9	5.98	151.9	8.81	223.9	NS	Y	Y			

T: Thrust-Wire Nut S: Slip Nut (see "Fitting Identification" in Appendix for details)

# BSPB (British Standard Pipe Parallel)

Female | 90° Elbow | Swivel

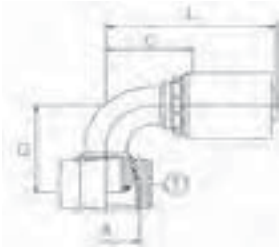

S=Skive  
NS=Non-Skive  
DG=Dual-Grip™

Descriptive #	Product #	SAP #	Hose Size ID		Thread Size (A)	Hex-1 Wrench Size	Drop (D)		Cut-Off (C)		Length (L)		Skive Type	SR1SN,	SR2SN,	SR16SC,	SCP3,	XCP4
			in.	mm			in.	mm	in.	mm	in.	mm		in.	mm	DR1SN, SFS	DR2SN, LR2SN	
B2-BPFX90-0404	14120-0404	20242868	1/4	6.4	1/4-19	19	1.14	29.0	1.14	29.0	2.12	53.8	NS	Y	Y	Y	Y	Y
B2-BPFX90-0606	14120-0606	20242864	3/8	9.5	3/8-19	22	1.65	41.9	1.38	35.1	2.43	61.7	NS	Y	Y	Y	Y	Y
B2-BPFX90-0608	14120-0608	20242859	3/8	9.5	1/2-14	27	1.40	35.6	1.34	34.0	2.39	60.7	NS	Y	Y	Y	Y	Y
B2-BPFX90-0808	14120-0808	20242870	1/2	12.7	1/2-14	27	1.61	40.9	1.42	36.1	2.67	67.7	NS	Y	Y	Y	Y	Y
B2-BPFX90-1010 <sup>C</sup>	14120-1010	20242863	5/8	15.9	5/8-14	27	1.85	47.0	1.89	48.0	3.25	82.5	NS	Y	Y	Y	Y	Y
B2-BPFX90-1212 <sup>C</sup>	14120-1212	20242866	3/4	19.0	3/4-14	32	2.09	53.1	1.93	49.0	3.48	88.5	NS	Y	Y	Y	Y	Y
B2-BPFX90-1616 <sup>C</sup>	14120-1616	20242845	1	25.4	1-11	38	2.72	69.1	2.95	74.9	4.73	120.0	NS	Y	Y	Y	Y	Y
S4-BPFX90-2020 <sup>T</sup>	28120-2020	20242848	1 1/4	31.8	1 1/4-11	50	3.27	83.1	3.23	82.0	5.28	134.1	NS	Y	Y	Y		
S4-BPFX90-2424 <sup>T</sup>	28120-2424	20242843	1 1/2	38.1	1 1/2-11	55	3.78	96.0	3.78	96.0	6.11	155.1	NS	Y	Y			
S4-BPFX90-3232 <sup>T</sup>	28120-3232	20242867	2	50.8	2-11	70	5.35	135.9	5.04	128.0	7.87	200.0	NS	Y	Y			

C: Crimp Nut T: Thrust-Wire Nut (see "Fitting Identification" in Appendix for details)

# BSPB (British Standard Pipe Parallel)

Male

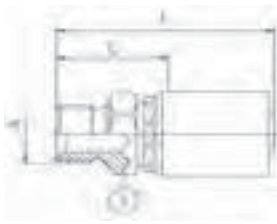

S=Skive  
NS=Non-Skive  
DG=Dual-Grip™

Descriptive #	Product #	SAP #	Hose Size ID		Thread Size (A)	Hex-1 Wrench Size	Cut-Off (C)		Length (L)		Skive Type	SR1SN,	SR2SN,	SR16SC,	SCP3,	XCP4
			in.	mm			in.	mm	in.	mm		DR1SN, SFS	DR2SN, LR2SN	XR16SC, ARC16SC, DR16SC	XCP3, ACP3	
B2-BPM-0404	14130-0404	20242840	1/4	6.4	1/4-19	19	1.03	26.2	2.01	51.1	NS	Y	Y	Y	Y	Y
B2-BPM-0606	14130-0606	20242829	3/8	9.5	3/8-19	22	1.10	28.0	2.15	54.6	NS	Y	Y	Y	Y	Y
B2-BPM-0608	14130-0608	20242830	3/8	9.5	1/2-14	27	1.24	31.5	2.29	58.1	NS	Y	Y	Y	Y	Y
B2-BPM-0806	14130-0806	20242835	1/2	12.7	3/8-19	22	1.12	28.5	2.37	60.2	NS	Y	Y	Y	Y	Y
B2-BPM-0808	14130-0808	20242827	1/2	12.7	1/2-14	27	1.26	32.0	2.51	63.7	NS	Y	Y	Y	Y	Y
B2-BPM-1010	14130-1010	20242828	5/8	15.9	5/8-14	30	1.35	34.3	2.71	68.8	NS	Y	Y	Y	Y	Y
B2-BPM-1212	14130-1212	20242832	3/4	19.0	3/4-14	32	1.45	36.7	3.00	76.1	NS	Y	Y	Y	Y	Y
B2-BPM-1616	14130-1616	20242838	1	25.4	1-11	41	1.69	43.0	3.47	88.1	NS	Y	Y	Y	Y	Y
S4-BPM-2020	28130-2020	20242836	1 1/4	31.8	1 1/4-11	50	1.89	48.0	3.40	86.3	NS	Y	Y	Y		
S4-BPM-2424	28130-2424	20242837	1 1/2	38.1	1 1/2-11	55	2.00	50.7	4.33	109.9	NS	Y	Y			
S4-BPM-3232	28130-3232	20242833	2	50.8	2-11	70	2.28	57.9	5.11	129.8	NS	Y	Y			

## BSPT (British Standard Pipe Tapered)

Male

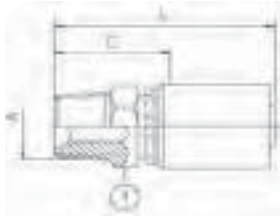

S=Skive  
NS=Non-Skive  
DG=Dual-Grip™

Descriptive #	Product #	SAP #	Hose Size ID		Thread Size (A)	Hex-1 Wrench Size	Cut-Off (C)		Length (L)		Skive Type	SR1SN, DR1SN, SFS	SR2SN, DR2SN, LR2SN	SR16SC, XR16SC, ARC16SC, DR16SC	SCP3, XCP3	XCP4
			in.	mm			in.	mm	in.	mm						
B2-BTM-0404	14170-0404	20242873	1/4	6.4	1/4-19	17	1.06	27.0	2.04	51.9	NS	Y	Y	Y	Y	Y
B2-BTM-0606	14170-0606	20242872	3/8	9.5	3/8-19	19	1.10	27.9	2.15	54.6	NS	Y	Y	Y	Y	Y
B2-BTM-0808	14170-0808	20242871	1/2	12.7	1/2-14	22	1.31	33.1	2.55	64.8	NS	Y	Y	Y	Y	Y
B2-BTM-1212	14170-1212	20242876	3/4	19.0	3/4-14	27	1.36	34.6	2.92	74.1	NS	Y	Y	Y	Y	Y
B2-BTM-1616	14170-1616	20242874	1	25.4	1-11	36	1.73	43.9	3.51	89.0	NS	Y	Y	Y	Y	Y

## BSP Flat Seat (British Standard Pipe)

Female | Swivel

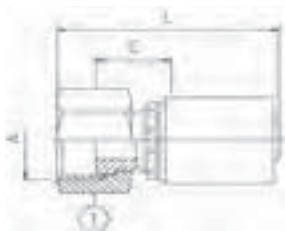

S=Skive  
NS=Non-Skive  
DG=Dual-Grip™

Descriptive #	Product #	SAP #	Hose Size ID		Thread Size (A)	Hex-1 Wrench Size	Cut-Off (C)		Length (L)		Skive Type	SR1SN, DR1SN, SFS	SR2SN, DR2SN, LR2SN	SR16SC, XR16SC, ARC16SC, DR16SC	SCP3, XCP3	XCP4
			in.	mm			in.	mm	in.	mm						
B2-BFFX-0606	14100-0606	20242815	3/8	9.5	3/8-19	22	0.75	19.0	1.80	45.6	NS	Y	Y	Y	Y	Y
B2-BFFX-0608	14100-0608	20242814	3/8	9.5	1/2-14	27	0.80	20.2	1.84	46.8	NS	Y	Y	Y	Y	Y
B2-BFFX-0808	14100-0808	20242816	1/2	12.7	1/2-14	27	0.82	20.9	2.07	52.5	NS	Y	Y	Y	Y	Y
B2-BFFX-0812	14100-0812	20242812	1/2	12.7	3/4-14	32	0.97	24.5	2.21	56.2	NS	Y	Y	Y	Y	Y
B2-BFFX-1212 <sup>c</sup>	14100-1212	20242813	3/4	19.0	3/4-14	32	0.72	18.2	2.27	57.6	NS	Y	Y	Y	Y	Y

C: Crimp Nut (see "Fitting Identification" in Appendix for details)

# DIN 24° Light

Female | Swivel

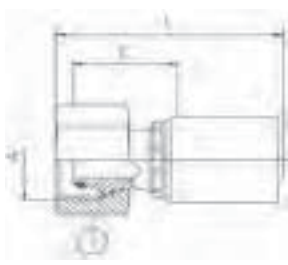

S=Skive  
NS=Non-Skive  
DG=Dual-Grip™

Descriptive #	Product #	SAP #	Hose Size ID		Thread Size (A)	Hex-1 Wrench Size	Cut-Off (C)		Length (L)		Skive Type	SR1SN, DR1SN, SFS	SR2SN, DR2SN, LR2SN	SR16SC, XR16SC, ARC16SC, DR16SC	SCP3, XCP3, ACP3	XCP4
			in.	mm			mm	in.	mm	in.						
B2-DLFX-0412T	14240-0412	20241852	1/4	6.4	12x1.5	14	1.07	27.2	2.05	52.0	NS	Y	Y	Y	Y	Y
B2-DLFX-0414	14240-0414	20241837	1/4	6.4	14x1.5	17	1.02	25.9	2.00	50.8	NS	Y	Y	Y	Y	Y
B2-DLFX-0416	14240-0416	20241845	1/4	6.4	16x1.5	19	1.08	27.4	2.06	52.2	NS	Y	Y	Y	Y	Y
B2-DLFX-0616	14240-0616	20241842	3/8	9.5	16x1.5	19	2.21	56.2	2.26	57.5	NS	Y	Y	Y	Y	Y
B2-DLFX-0618	14240-0618	20241843	3/8	9.5	18x1.5	22	1.08	27.5	2.13	54.2	NS	Y	Y	Y	Y	Y
B2-DLFX-0622	14240-0622	20782409	3/8	9.5	22x1.5		1.18	30.0	2.23	56.7	NS	Y	Y	Y	Y	Y
B2-DLFX-0822	14240-0822	20241859	1/2	12.7	22x1.5	27	1.21	30.7	2.46	62.4	NS	Y	Y	Y	Y	Y
B2-DLFX-1026	14240-1026	20241844	5/8	15.9	26x1.5	32	1.24	31.5	2.60	65.9	NS	Y	Y	Y	Y	Y
B2-DLFX-1230	14240-1230	20241840	3/4	19.0	30x2.0	36	1.42	36.0	2.97	75.4	NS	Y	Y	Y	Y	Y
B2-DLFX-1636	14240-1636	20241871	1	25.4	36x2.0	41	1.49	37.9	3.27	83.0	NS	Y	Y	Y	Y	Y
S4-DLFX-2045	28240-2045	20241857	1 1/4	31.8	45x2.0	50	1.74	44.1	3.78	96.1	NS	Y	Y	Y		
S4-DLFX-2452	28240-2452	20441314	1 1/2	38.1	52x2.0	60	1.74	44.1	4.07	103.3	NS	Y	Y			

T: Thrust-Wire Nut (see "Fitting Identification" in Appendix for details)

# DIN 24° Light

Female | 45° Elbow | Swivel

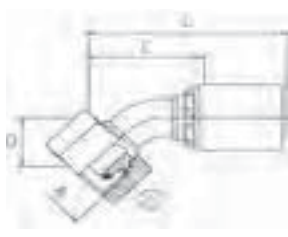

S=Skive  
NS=Non-Skive  
DG=Dual-Grip™

Descriptive #	Product #	SAP #	Hose Size ID		Thread Size (A)	Hex-1 Wrench Size	Drop (D)		Cut-Off (C)		Length (L)		Skive Type	SR1SN, DR1SN, SFS	SR2SN, DR2SN, LR2SN	SR16SC, XR16SC, ARC16SC, DR16SC	SCP3, XCP3, ACP3	XCP4
			in.	mm			mm	in.	mm	in.	mm	in.						
B2-DLFX45-0414	14245-0414	20241855	1/4	6.4	14x1.5	17	0.69	17.5	1.69	42.9	2.67	67.8	NS	Y	Y	Y	Y	Y
B2-DLFX45-0416	14245-0416	20241860	1/4	6.4	16x1.5	19	0.79	20.1	1.65	41.9	2.63	66.8	NS	Y	Y	Y	Y	Y
B2-DLFX45-0616	14245-0616	20441216	3/8	9.5	16x1.5	19	0.71	18.0	1.73	43.9	2.78	70.6	NS	Y	Y	Y	Y	Y
B2-DLFX45-0618	14245-0618	20241862	3/8	9.5	18x1.5	22	0.77	19.6	1.85	47.0	2.90	73.6	NS	Y	Y	Y	Y	Y
B2-DLFX-0622	14245-0622	20782411	3/8	9.5	22x1.5		0.83	21.1	2.14	54.5	3.19	81.1	NS	Y	Y	Y	Y	Y
B2-DLFX45-0822	14245-0822	20241858	1/2	12.7	22x1.5	27	0.83	21.1	2.17	55.1	3.42	86.8	NS	Y	Y	Y	Y	Y
B2-DLFX45-1026	14245-1026	20241863	5/8	15.9	26x1.5	32	0.94	23.9	2.56	65.0	3.92	99.5	NS	Y	Y	Y	Y	Y
B2-DLFX45-1230	14245-1230	20241861	3/4	19.0	30x2.0	36	1.26	32.0	2.72	69.1	4.27	108.5	NS	Y	Y	Y	Y	Y
B2-DLFX45-1636	14245-1636	20241856	1	25.4	36x2.0	41	1.26	32.0	3.58	90.9	5.36	136.0	NS	Y	Y	Y	Y	Y
S4-DLFX45-2452	28245-2452	20588801	1 1/2	38.1	52x2.0	60	1.85	47.0	4.49	114.0	6.82	173.1	NS	Y	Y			

# DIN 24° Light

Female | 90° Elbow | Swivel

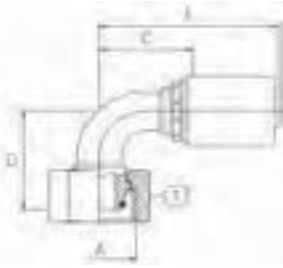

S=Skive  
NS=Non-Skive  
DG=Dual-Grip™

Descriptive #	Product #	SAP #	Hose Size ID		Thread Size (A)	Hex-1 Wrench Size	Drop (D)		Cut-Off (C)		Length (L)		Skive Type	SR1SN, DR1SN, SFS	SR2SN, DR2SN, LR2SN	SR16SC, XR16SC, ARC16SC, DR16SC	SCP3, XCP3, ACP3	XCP4
			in.	mm			mm	in.	mm	in.	mm	in.						
B2-DLFX90-0412	14250-0412	20241866	1/4	6.4	12x1.5	14	1.02	25.9	1.14	29.0	2.12	53.8	NS	Y	Y	Y	Y	Y
B2-DLFX90-0414	14250-0414	20241867	1/4	6.4	14x1.5	17	1.28	32.5	1.10	27.9	2.08	52.8	NS	Y	Y	Y	Y	Y
B2-DLFX90-0416	14250-0416	20241868	1/4	6.4	16x1.5	19	1.28	32.5	1.10	27.9	2.08	52.8	NS	Y	Y	Y	Y	Y
B2-DLFX90-0616	14250-0616	20289910	3/8	9.5	16x1.5	19	1.42	36.1	1.18	30.0	2.23	56.6	NS	Y	Y	Y	Y	Y
B2-DLFX90-0618	14250-0618	20241870	3/8	9.5	18x1.5	22	1.54	39.1	1.30	33.0	2.35	59.7	NS	Y	Y	Y	Y	Y
B2-DLFX90-0622	14250-0622	20782412	3/8	9.5	22x1.5		1.59	40.4	1.54	39.2	2.59	65.9	NS	Y	Y	Y	Y	Y
B2-DLFX90-0822	14250-0822	20241865	1/2	12.7	22x1.5	27	1.59	40.4	1.57	39.9	2.82	71.6	NS	Y	Y	Y	Y	Y
B2-DLFX90-1026	14250-1026	20241853	5/8	15.9	26x1.5	32	1.89	48.0	2.01	51.1	3.37	85.5	NS	Y	Y	Y	Y	Y
B2-DLFX90-1230	14250-1230	20241869	3/4	19.0	30x2.0	36	2.32	58.9	2.05	52.1	3.60	91.5	NS	Y	Y	Y	Y	Y
B2-DLFX90-1636	14250-1636	20241864	1	25.4	36x2.0	41	2.68	68.1	3.07	78.0	4.85	123.1	NS	Y	Y	Y	Y	Y
S4-DLFX90-2045	28250-2045	20241872	1 1/4	31.8	45x2.0	50	3.50	88.9	3.54	89.9	5.59	141.9	NS	Y	Y	Y		
S4-DLFX90-2452	28250-2452	20588800	1 1/2	38.1	52x2.0	60	3.84	97.5	4.21	107.0	6.54	166.1	NS	Y	Y			
S4-DLFX90XL-2452	28224-2452	20793531	1 1/2	38.1	52x2.0								NS	Y	Y			

# DIN 24° Light

Male

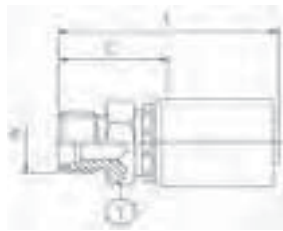

S=Skive  
NS=Non-Skive  
DG=Dual-Grip™

Descriptive #	Product #	SAP #	Hose Size ID		Thread Size (A)	Hex-1 Wrench Size	Cut-Off (C)		Length (L)		Skive Type	SR1SN, DR1SN, SFS	SR2SN, DR2SN, LR2SN	SR16SC, XR16SC, ARC16SC, DR16SC	SCP3, XCP3, ACP3	XCP4
			in.	mm			mm	in.	mm	in.						
B2-DLM-0412	14255-0412	20241847	1/4	6.4	12x1.5	14	0.84	21.4	1.82	46.3	NS	Y	Y	Y	Y	Y
B2-DLM-0414	14255-0414	20241848	1/4	6.4	14x1.5	14	0.84	21.4	1.82	46.3	NS	Y	Y	Y	Y	Y
B2-DLM-0416	14255-0416	20241849	1/4	6.4	16x1.5	17	0.92	23.4	1.90	48.3	NS	Y	Y	Y	Y	Y
B2-DLM-0616	14255-0616	20241850	3/8	9.5	16x1.5	17	0.93	23.6	1.98	50.2	NS	Y	Y	Y	Y	Y
B2-DLM-0618	14255-0618	20241838	3/8	9.5	18x1.5	19	0.96	24.4	2.01	51.1	NS	Y	Y	Y	Y	Y
B2-DLM-0622	14255-0622	20274103	3/8	9.5	22x1.5	22	1.00	25.4	2.05	52.1	NS	Y	Y	Y	Y	Y
B2-DLM-0822	14255-0822	20241846	1/2	12.7	22x1.5	22	1.02	26.0	2.27	57.6	NS	Y	Y	Y	Y	Y
B2-DLM-1026	14255-1026	20241851	5/8	15.9	26x1.5	27	1.07	27.1	2.42	61.6	NS	Y	Y	Y	Y	Y
B2-DLM-1230	14255-1230	20241854	3/4	19.0	30x2.0	32	1.24	31.5	2.79	70.9	NS	Y	Y	Y	Y	Y
B2-DLM-1636	14255-1636	20241839	1	25.4	36x2.0	36	1.34	34.1	3.12	79.1	NS	Y	Y	Y	Y	Y



# DIN 24° Heavy

Female | Swivel

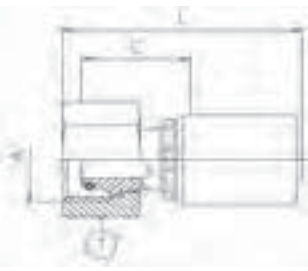

S=Skive  
NS=Non-Skive  
DG=Dual-Grip™

Descriptive #	Product #	SAP #	Hose Size ID		Thread Size (A)	Hex-1 Wrench Size	Cut-Off (C)		Length (L)		Skive Type	SR1SN, DR1SN, SFS	SR2SN, DR2SN, LR2SN	SR16SC, XR16SC, ARC16SC, DR16SC	SCP3, XCP3, ACP3	XCP4
			in.	mm			mm	in.	mm	in.						
B2-DHFX-0416	14210-0416	20241801	1/4	6.4	16x1.5	19	1.20	30.5	2.18	55.4	NS	Y	Y	Y	Y	Y
B2-DHFX-0418	14210-0418	20241805	1/4	6.4	18x1.5	22	1.21	30.8	2.19	55.7	NS	Y	Y	Y	Y	Y
B2-DHFX-0618	14210-0618	20293217	3/8	9.5	18x1.5	22	1.23	31.3	2.28	57.9	NS	Y	Y	Y	Y	Y
B2-DHFX-0620	14210-0620	20241796	3/8	9.5	20x1.5	24	1.21	30.8	2.26	57.4	NS	Y	Y	Y	Y	Y
B2-DHFX-0622	14210-0622	20241803	3/8	9.5	22x1.5	27	1.42	36.2	2.47	62.8	NS	Y	Y	Y	Y	Y
B2-DHFX-0624	14210-0624	20790636	3/8	9.5	24x1.5						NS	Y	Y	Y	Y	Y
B2-DHFX-0820	14210-0820	20441214	1/2	12.7	20x1.5	24	1.24	31.4	2.48	63.0	NS	Y	Y	Y	Y	Y
B2-DHFX-0824	14210-0824	20241815	1/2	12.7	24x1.5	30	1.44	36.5	2.68	68.2	NS	Y	Y	Y	Y	Y
B2-DHFX-1030	14210-1030	20241807	5/8	15.9	30x2.0	36	1.64	41.7	2.99	76.0	NS	Y	Y	Y	Y	Y
B2-DHFX-1230 <sup>T</sup>	14210-1230	20241800	3/4	19.0	30x2.0	36	1.62	41.0	3.17	80.5	NS	Y	Y	Y	Y	Y
B2-DHFX-1236	14210-1236	20241799	3/4	19.0	36x2.0	46	1.89	47.9	3.44	87.4	NS	Y	Y	Y	Y	Y
B2-DHFX-1642	14210-1642	20241830	1	25.4	42x2.0	50	1.88	47.9	3.66	92.9	NS	Y	Y	Y	Y	
S4-DHFX-2042	28210-2042	20241721	1 1/4	31.8	42x2.0	50	1.96	49.8	4.01	101.8	NS	Y	Y	Y		
S4-DHFX-2052	28210-2052	20241818	1 1/4	31.8	52x2.0	60	2.20	55.8	4.24	107.7	NS	Y	Y	Y		

T: Thrust-Wire Nut (see "Fitting Identification" in Appendix for details)

# DIN 24° Heavy

Female | 45° Elbow | Swivel

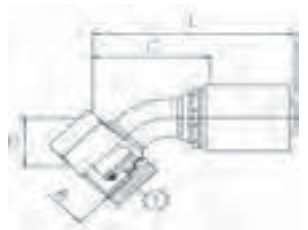

S=Skive  
NS=Non-Skive  
DG=Dual-Grip™

Descriptive #	Product #	SAP #	Hose Size ID		Thread Size (A)	Hex-1 Wrench Size	Drop (D)		Cut-Off (C)		Length (L)		Skive Type	SR1SN, DR1SN, SFS	SR2SN, DR2SN, LR2SN	SR16SC, XR16SC, ARC16SC, DR16SC	SCP3, XCP3, ACP3	XCP4
			in.	mm			mm	in.	mm	in.	mm	in.						
B2-DHFX45-0416	14215-0416	20441303	1/4	6.4	16x1.5	19	0.63	16.0	1.93	49.0	2.91	73.9	NS	Y	Y	Y	Y	Y
B2-DHFX45-0418	14215-0418	20241817	1/4	6.4	18x1.5	22	0.75	19.1	1.69	42.9	2.67	67.8	NS	Y	Y	Y	Y	Y
B2-DHFX45-0620	14215-0620	20241821	3/8	9.5	20x1.5	24	0.79	20.1	2.01	51.1	3.06	77.7	NS	Y	Y	Y	Y	Y
B2-DHFX45-0622	14215-0622	20241822	3/8	9.5	22x1.5	27	0.83	21.1	2.09	53.1	3.14	79.7	NS	Y	Y	Y	Y	Y
B2-DHFX45-0624	14215-0624	20790638	3/8	9.5	24x1.5		0.85	21.6	2.17	55.2	3.22	81.9	NS	Y	Y	Y	Y	Y
B2-DHFX45-0824	14215-0824	20241819	1/2	12.7	24x1.5	30	0.85	21.6	2.20	55.9	3.45	87.6	NS	Y	Y	Y	Y	Y
B2-DHFX45-1030	14215-1030	20241823	5/8	15.9	30x2.0	36	1.18	30.0	2.60	66.0	3.96	100.5	NS	Y	Y	Y	Y	Y
B2-DHFX45-1236	14215-1236	20241820	3/4	19.0	36x2.0	46	1.30	33.0	2.72	69.1	4.27	108.5	NS	Y	Y	Y	Y	Y
B2-DHFX45-1642	14215-1642	20241828	1	25.4	42x2.0	50	1.59	40.4	4.33	110.0	6.11	155.1	NS	Y	Y	Y	Y	

# DIN 24° Heavy

Female | 90° Elbow | Swivel

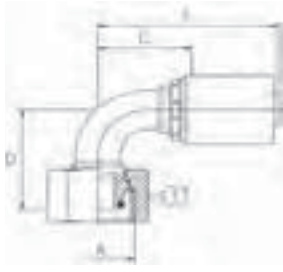

S=Skive  
NS=Non-Skive  
DG=Dual-Grip™

Descriptive #	Product #	SAP #	Hose Size ID		Thread Size (A)	Hex-1 Wrench Size	Drop (D)		Cut-Off (C)		Length (L)		Skive Type	SR1SN, DR1SN, SFS	SR2SN, DR2SN, LR2SN	SR16SC, XR16SC, ARC16SC, DR16SC	SCP3, XCP3, ACP3	XCP4
			in.	mm			in.	mm	in.	mm	in.	mm						
B2-DHFX90-0416	14220-0416	20477376	1/4	6.4	16x1.5	19	1.30	33.0	1.26	32.0	2.24	56.9	NS	Y	Y	Y	Y	Y
B2-DHFX90-0418	14220-0418	20241829	1/4	6.4	18x1.5	22	1.34	34.0	1.06	26.9	2.04	51.8	NS	Y	Y	Y	Y	Y
B2-DHFX90-0618	14220-0618	20441215	3/8	9.5	18x1.5	22	1.34	34.0	1.18	30.0	2.23	56.6	NS	Y	Y	Y	Y	Y
B2-DHFX90-0620	14220-0620	20241797	3/8	9.5	20x1.5	24	1.52	38.6	1.34	34.0	2.39	60.7	NS	Y	Y	Y	Y	Y
B2-DHFX90-0622	14220-0622	20241835	3/8	9.5	22x1.5	27	1.59	40.4	1.34	34.0	2.39	60.7	NS	Y	Y	Y	Y	Y
B2-DHFX90-0624	14220-0624	20790639	3/8	9.5	24x1.5								NS	Y	Y	Y	Y	Y
B2-DHFX90-0824	14220-0824	20241825	1/2	12.7	24x1.5	30	1.63	41.4	1.57	39.9	2.82	71.6	NS	Y	Y	Y	Y	Y
B2-DHFX90XL-0824	14224-0824	20790664	1/2	12.7	24x1.5								NS	Y	Y	Y	Y	Y
B2-DHFX90-1030	14220-1030	20241832	5/8	15.9	30x2.0	36	2.17	55.1	1.97	50.0	3.33	84.5	NS	Y	Y	Y	Y	Y
B2-DHFX90-1236	14220-1236	20241836	3/4	19.0	36x2.0	46	2.34	59.4	2.01	51.1	3.56	90.5	NS	Y	Y	Y	Y	Y
B2-DHFX90-1642	14220-1642	20241824	1	25.4	42x2.0	50	3.11	79.0	2.99	75.9	4.77	121.0	NS	Y	Y	Y	Y	Y
S4-DHFX90-2052	28220-2052	20265706	1 1/4	31.8	52x2.0	60	3.62	91.9	3.70	94.0	5.75	145.9	NS	Y	Y	Y		

# DIN 24° Heavy

Male

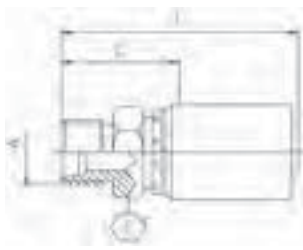

S=Skive  
NS=Non-Skive  
DG=Dual-Grip™

Descriptive #	Product #	SAP #	Hose Size ID		Thread Size (A)	Hex-1 Wrench Size	Cut-Off (C)		Length (L)		Skive Type	SR1SN, DR1SN, SFS	SR2SN, DR2SN, LR2SN	SR16SC, XR16SC, ARC16SC, DR16SC	SCP3, XCP3, ACP3	XCP4
			in.	mm			in.	mm	in.	mm						
B2-DHM-0416	14225-0416	20241810	1/4	6.4	16x1.5	17	0.95	24.2	1.93	49.1	NS	Y	Y	Y	Y	Y
B2-DHM-0418	14225-0418	20241811	1/4	6.4	18x1.5	19	0.99	25.2	1.97	50.1	NS	Y	Y	Y	Y	Y
B2-DHM-0620	14225-0620	20241813	3/8	9.5	20x1.5	22	1.00	25.4	2.05	52.1	NS	Y	Y	Y	Y	Y
B2-DHM-0622	14225-0622	20241804	3/8	9.5	22x1.5	22	1.08	27.4	2.13	54.1	NS	Y	Y	Y	Y	Y
B2-DHM-0824	14225-0824	20241809	1/2	12.7	24x1.5	24	1.14	29.0	2.39	60.7	NS	Y	Y	Y	Y	Y
B2-DHM-1030	14225-1030	20241814	5/8	15.9	30x2.0	32	1.31	33.1	2.66	67.6	NS	Y	Y	Y	Y	Y
B2-DHM-1230	14225-1230	20241812	3/4	19.0	30x2.0	32	1.33	33.7	2.88	73.1	NS	Y	Y	Y	Y	Y
B2-DHM-1236	14225-1236	20241816	3/4	19.0	36x2.0	36	1.48	37.7	3.04	77.1	NS	Y	Y	Y	Y	Y
B2-DHM-1642	14225-1642	20241808	1	25.4	42x2.0	46	1.66	42.1	3.43	87.2	NS	Y	Y	Y	Y	Y

# DIN 60°

Female | 45° Elbow | Swivel

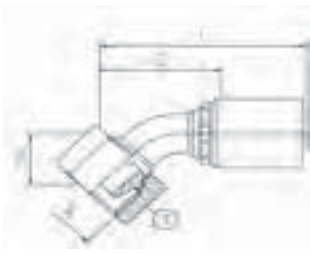

S=Skive  
NS=Non-Skive  
DG=Dual-Grip™

Descriptive #	Product #	SAP #	Hose Size ID		Thread Size (A)	Hex-1 Wrench Size	Drop (D)		Cut-Off (C)		Length (L)		Skive Type	SR1SN,	SR2SN,	SR16SC,	SCP3,	XCP4
			in.	mm			mm	in.	mm	in.	mm	in.		mm	DR1SN, SFS	DR2SN, LR2SN	XR16SC, ARC16SC, DR16SC	
B2-DNFX45-0414	14275-0414	20241882	1/4	6.4	14x1.5	17	0.63	16.0	1.38	35.1	2.36	59.9	NS	Y	Y	Y	Y	Y
B2-DNFX45-0416	14275-0416	20241881	1/4	6.4	16x1.5	19	0.67	17.0	1.42	36.1	2.40	61.0	NS	Y	Y	Y	Y	Y
B2-DNFX45-0618	14275-0618	20241873	3/8	9.5	18x1.5	22	0.77	19.6	1.69	42.9	2.74	69.6	NS	Y	Y	Y	Y	Y
B2-DNFX45-0822	14275-0822	20241879	1/2	12.7	22x1.5	27	0.79	20.1	2.17	55.1	3.42	86.8	NS	Y	Y	Y	Y	Y
B2-DNFX45-1026	14275-1026	20241880	5/8	15.9	26x1.5	32	1.02	25.9	2.44	62.0	3.80	96.4	NS	Y	Y	Y	Y	Y

# DIN 60°

Female | 90° Elbow | Swivel

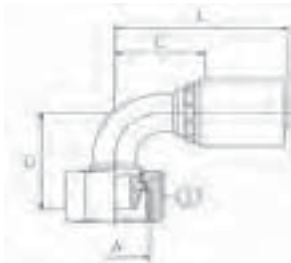

S=Skive  
NS=Non-Skive  
DG=Dual-Grip™

Descriptive #	Product #	SAP #	Hose Size ID		Thread Size (A)	Hex-1 Wrench Size	Drop (D)		Cut-Off (C)		Length (L)		Skive Type	SR1SN,	SR2SN,	SR16SC,	SCP3,	XCP4
			in.	mm			mm	in.	mm	in.	mm	in.		mm	DR1SN, SFS	DR2SN, LR2SN	XR16SC, ARC16SC, DR16SC	
B2-DNFX90-0414	14280-0414	20241878	1/4	6.4	14x1.5	17	1.28	32.5	1.18	30.0	2.16	54.9	NS	Y	Y	Y	Y	Y
B2-DNFX90-0416	14280-0416	20241877	1/4	6.4	16x1.5	19	1.28	32.5	1.10	27.9	2.08	52.8	NS	Y	Y	Y	Y	Y
B2-DNFX90-0616	14280-0616	20241876	3/8	9.5	16x1.5	19	1.26	32.0	1.18	30.0	2.23	56.6	NS	Y	Y	Y	Y	Y
B2-DNFX90-0618	14280-0618	20241875	3/8	9.5	18x1.5	22	1.46	37.1	1.30	33.0	2.44	62.0	NS	Y	Y	Y	Y	Y
B2-DNFX90-0822	14280-0822	20241883	1/2	12.7	22x1.5	27	1.57	39.9	1.57	39.9	2.82	71.6	NS	Y	Y	Y	Y	Y
B2-DNFX90-1026	14280-1026	20241874	5/8	15.9	26x1.5	32	1.85	47.0	2.05	52.1	3.41	86.5	NS	Y	Y	Y	Y	Y

# Japanese Komatsu® 30° Flare with Metric Threads

Female | Swivel

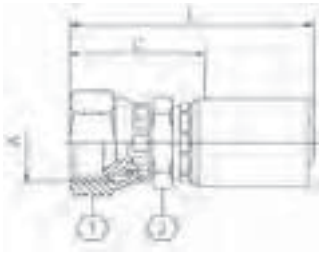

S=Skive  
NS=Non-Skive  
DG=Dual-Grip™

Descriptive #	Product #	SAP #	Hose Size ID		Thread Size (A)	Hex-1 Wrench Size	Hex-2 Wrench Size	Cut-Off (C)		Length (L)		Skive Type	SR1SN,	SR2SN,	SR16SC,	SCP3,	XCP4
			in.	mm				in.	mm	in.	mm		DR1SN,	DR2SN,	ARC16SC,	ACP3	
B2-KMFX-0414	14545-0414	20241888	1/4	6.4	14X1.5	19	17	1.22	30.9	2.20	55.8	NS	Y	Y	Y	Y	Y
B2-KMFX-0618	14545-0618	20241894	3/8	9.5	18X1.5	22	19	1.26	32.1	2.31	58.7	NS	Y	Y	Y	Y	Y
B2-KMFX-0822	14545-0822	20241891	1/2	12.7	22X1.5	27	22	1.38	35.2	2.63	66.8	NS	Y	Y	Y	Y	Y
B2-KMFX-1024	14545-1024	20241886	5/8	15.9	24X1.5	32	30	1.66	42.2	3.02	76.6	NS	Y	Y	Y	Y	Y
B2-KMFX-1230	14545-1230	20241884	3/4	19.0	30X1.5	36	30	1.84	46.7	3.39	86.1	NS	Y	Y	Y	Y	Y
B2-KMFX-1633	14545-1633	20241893	1	25.4	33X1.5	41	36	2.24	56.9	4.02	102.0	NS	Y	Y	Y	Y	Y
S4-KMFX-2036	28545-2036	20241889	1¼	31.8	36X1.5	46	46	2.50	63.6	4.55	115.5	NS	Y	Y	Y		
S4-KMFX-2442	28545-2442	20241890	1½	38.1	42X1.5	55	55	2.63	66.9	4.96	126.0	NS	Y	Y			

# Japanese Komatsu® 30° Flare with Metric Threads

Female | 45° Elbow | Swivel

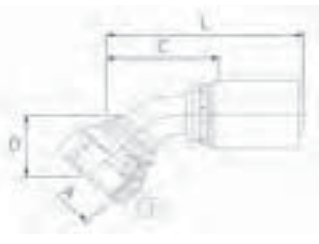

S=Skive  
NS=Non-Skive  
DG=Dual-Grip™

Descriptive #	Product #	SAP #	Hose Size ID		Thread Size (A)	Hex-1 Wrench Size	Drop (D)	Cut-Off (C)		Length (L)		Skive Type	SR1SN,	SR2SN,	SR16SC,	SCP3,	XCP4	
			in.	mm				in.	mm	in.	mm		DR1SN,	DR2SN,	ARC16SC,	ACP3		
B2-KMFX45-0414	14548-0414	20293383	1/4	6.4	14X1.5	19	0.61	15.5	1.50	38.1	2.48	63.0	NS	Y	Y	Y	Y	Y
B2-KMFX45-0618	14548-0618	20293384	3/8	9.5	18X1.5	22	0.71	18.0	1.73	43.9	2.78	70.6	NS	Y	Y	Y	Y	Y
B2-KMFX45-0822	14548-0822	20293385	1/2	12.7	22X1.5		1.16	29.5	2.20	55.9	3.45	87.6	NS	Y	Y	Y	Y	Y
B2-KMFX45-1024	14548-1024	20293386	5/8	15.9	24X1.5	32	1.32	33.5	2.27	57.7	4.08	103.6	NS	Y	Y	Y	Y	Y
B2-KMFX45-1230	14548-1230	20293387	3/4	19.0	30X1.5	36	1.67	42.4	3.11	79.0	4.66	118.4	NS	Y	Y	Y	Y	Y
B2-KMFX45-1633	14548-1633	20293388	1	25.4	33X1.5	41	2.52	64.0	4.69	119.1	6.47	164.2	NS	Y	Y	Y	Y	Y

# Japanese Komatsu® 30° Flare with Metric Threads

Female | 90° Elbow | Swivel

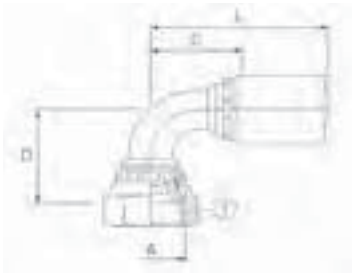

S=Skive  
NS=Non-Skive  
DG=Dual-Grip™

Descriptive #	Product #	SAP #	Hose Size ID		Thread Size (A)		Hex-1 Wrench Size	Drop (D)		Cut-Off (C)		Length (L)		Skive Type	SR1SN,	SR2SN,	SR16SC,	SR16SC,	SCP3,
			in.	mm	mm	in.	mm	in.	mm	in.	mm	in.	mm		SFS	LR2SN	XR16SC,	DR16SC	XCP3,
B2-KMFX90-0414	14550-0414	20293389	1/4	6.4	14X1.5	19	1.16	29.5	1.30	33.0	2.28	57.9	NS	Y	Y	Y	Y	Y	Y
B2-KMFX90-0822	14550-0822	20293391	1/2	12.7	22X1.5	27	2.09	53.1	1.74	44.1	2.98	75.8	NS	Y	Y	Y	Y	Y	Y
B2-KMFX90-1024	14550-1024	20293392	5/8	15.9	24X1.5	32	2.44	62.0	1.97	50.0	3.33	84.5	NS	Y	Y	Y	Y	Y	Y
B2-KMFX90-1230	14550-1230	20293393	3/4	19.0	30X1.5	36	2.99	75.9	2.05	52.1	3.60	91.5	NS	Y	Y	Y	Y	Y	Y
B2-KMFX90-1633	14550-1633	20293394	1	25.4	33X1.5	41	4.49	114.0	3.11	79.0	4.89	124.1	NS	Y	Y	Y	Y	Y	Y

# JIS 30° (Parallel Pipe Threads)

Female | Swivel

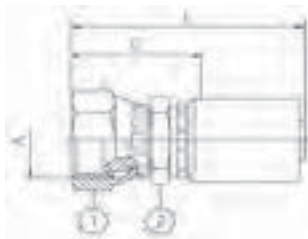

S=Skive  
NS=Non-Skive  
DG=Dual-Grip™

Descriptive #	Product #	SAP #	Hose Size ID		Thread Size (A)		Hex-1 Wrench Size	Hex-2 Wrench Size	Cut-Off (C)		Length (L)		Skive Type	SR1SN,	SR2SN,	SR16SC,	SR16SC,	SCP3,
			in.	mm	mm	mm	in.	mm	in.	mm	in.	mm		SFS	LR2SN	XR16SC,	DR16SC	XCP3,
B2-JSFX-0404	14520-0404	20242055	1/4	6.4	1/4-19	19	17	1.22	30.9	2.20	55.8	NS	Y	Y	Y	Y	Y	Y
B2-JSFX-0606	14520-0606	20242058	3/8	9.5	3/8-19	22	19	1.26	32.1	2.31	58.7	NS	Y	Y	Y	Y	Y	Y
B2-JSFX-0808	14520-0808	20242057	1/2	12.7	1/2-14	27	22	1.39	35.2	2.63	66.9	NS	Y	Y	Y	Y	Y	Y
B2-JSFX-1012	14520-1012	20293229	5/8	15.9	3/4-14	36	30	1.56	39.7	2.92	74.1	NS	Y	Y	Y	Y	Y	Y
B2-JSFX-1212	14520-1212	20242054	3/4	19.0	3/4-14	36	30	1.58	40.2	3.14	79.6	NS	Y	Y	Y	Y	Y	Y
B2-JSFX-1616	14520-1616	20242052	1	25.4	1-11	41	36	1.87	47.5	3.65	92.6	NS	Y	Y	Y	Y	Y	Y
S4-JSFX-2020T	28520-2020	20241722	1 1/4	31.8	1 1/4-11	50	46	2.16	54.9	4.21	106.9	NS	Y	Y	Y	Y	Y	Y

C: Crimp Nut T: Thrust-Wire Nut (see "Fitting Identification" in Appendix for details)

## How to Use the Fitting Tables

This section lists ALL fittings that are compatible with the following hoses:

Hose Family	Hose Description
SR7	SAE 100R7/EN 855 R7
TR7	SAE 100R7 (Twin-Line)
NR7	SAE 100R7 (Non-Conductive)
BR7	SAE 100R7 (Twin-Line, Non-Conductive)
SR8	SAE 100R8/EN 855 R8
TR8	SAE 100R8 (Twin-Line)
NR8	SAE 100R8 (Non-Conductive)
SR18	SAE 100R18

## Fitting Description

Fitting Type

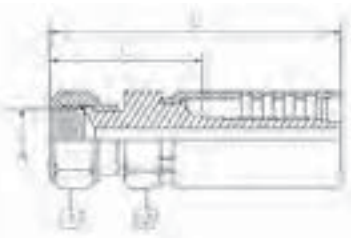

Descriptive #	Product #	SAP #	Hose Size ID		Thread Size (A)	Hex-1 Wrench Size	Hex-2 Wrench Size	Cut-Off (C)				Length (L)	Hose Family				
			in.	mm				in.	mm	in.	mm		in.	mm	SR7, TR7, NR7, BR7	SR8, TR8, NR8	SR18
Ultra-Crimp, PN1	32400-0204	20243997	1/8	3.2	7/16-20	5/8	1/2	1.06	27.0	1.71	43.5	Y			Y		
Ultra-Crimp, PN2	32400-0303	20243995	3/16	4.8	3/8-24	9/16	9/16	1.31	33.3	2.21	56.2	Y					
Ultra-Crimp, PN3	32400-0304	20243994	3/16	4.8	7/16-20	5/8	9/16	1.38	34.9	2.16	54.8	Y					

Choose fittings carefully, considering the working pressure of both hose and fitting. The maximum working pressure of the hose assembly is the lesser of the rated working pressure of the hose and the fitting. See page 313 for working pressure.

A "Y" in the hose compatibility columns indicates that the fitting is an **Ultra-Crimp™** style fitting and that it works for that particular hose.

A **blank space** in the hose compatibility columns indicates that the fitting **DOES NOT** work for that particular hose.

# JIC 37° Flare (SAE J514)

Female | Swivel

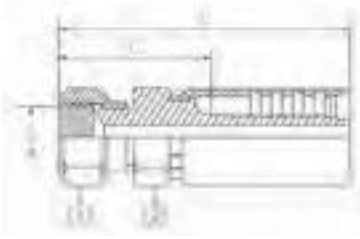

Descriptive #	Product #	SAP #	Hose Size ID		Thread Size (A)	Hex-1 Wrench Size	Hex-2 Wrench Size	Cut-Off (C)		Length (L)		SR7, TR7, NR7, BR7	SR8, TR8, NR8	SR18
			in.	mm	in.	in.	in.	in.	mm	in.	mm			
T7-JCFX-0204	32400-0204	20243997	1/8	3.2	7/16-20	5/8	1/2	1.06	27.0	1.71	43.5	Y		
T7-JCFX-0303	32400-0303	20243995	3/16	4.8	3/8-24	9/16	9/16	1.31	33.3	2.21	56.2	Y		
T7-JCFX-0304	32400-0304	20243994	3/16	4.8	7/16-20	5/8	9/16	1.38	34.9	2.16	54.8	Y		
T8-JCFX-0304	34400-0304	20243993	3/16	4.8	7/16-20	5/8	9/16	1.38	34.9	2.16	54.8		Y	
T7-JCFX-0305	32400-0305	20243996	3/16	4.8	1/2-20	3/4	9/16	1.38	34.9	2.16	54.8	Y		
T8-JCFX-0305	34400-0305	20243999	3/16	4.8	1/2-20	3/4	9/16	1.38	34.9	2.16	54.8		Y	
T7-JCFX-0404	32400-0404	20244000	1/4	6.4	7/16-20	5/8	5/8	1.44	36.5	2.53	64.3	Y		Y
T7-JCFX-0404S	32400-0404S	20298359	1/4	6.4	7/16-20	5/8	5/8	1.44	36.5	2.53	64.3	Y		Y
T8-JCFX-0404	34400-0404	20243991	1/4	6.4	7/16-20	5/8	5/8	1.44	36.5	2.53	64.3		Y	
T8-JCFX-0404S	34400-0404S	20435884	1/4	6.4	7/16-20	5/8	5/8	1.44	36.5	2.53	64.3		Y	
T7-JCFX-0405	32400-0405	20244002	1/4	6.4	1/2-20	3/4	5/8	1.44	36.5	2.53	64.3	Y		Y
T8-JCFX-0405	34400-0405	20244001	1/4	6.4	1/2-20	3/4	5/8	1.44	36.5	2.53	64.3		Y	
T7-JCFX-0406	32400-0406	20244007	1/4	6.4	9/16-18	3/4	5/8	1.44	36.5	2.53	64.3	Y		Y
T8-JCFX-0406	34400-0406	20243998	1/4	6.4	9/16-18	3/4	5/8	1.44	36.5	2.53	64.3		Y	
T7-JCFX-0505	32400-0505	20244010	5/16	7.9	1/2-20	3/4	5/8	1.25	31.8	2.53	64.3	Y		Y
T7-JCFX-0506	32400-0506	20244009	5/16	7.9	9/16-18	3/4	5/8	1.38	34.9	2.53	64.3	Y		Y
T7-JCFX-0604	32400-0604	20244015	3/8	9.5	7/16-20	5/8	13/16	1.25	31.8	2.69	68.3	Y		Y
T8-JCFX-0604	34400-0604	20244014	3/8	9.5	7/16-20	5/8	13/16	1.25	31.8	2.69	68.3		Y	
T7-JCFX-0606	32400-0606	20244011	3/8	9.5	9/16-18	3/4	3/4	1.50	38.1	2.81	71.5	Y		Y
T8-JCFX-0606	34400-0606	20244008	3/8	9.5	9/16-18	3/4	3/4	1.38	34.9	2.81	71.5		Y	
T7-JCFX-0608	32400-0608	20244017	3/8	9.5	3/4-16	15/16	3/4	1.38	34.9	2.81	71.5	Y		Y
T8-JCFX-0608	34400-0608	20244018	3/8	9.5	3/4-16	15/16	3/4	1.38	34.9	2.81	71.5		Y	
T7-JCFX-0610	32400-0610	20244013	3/8	9.5	7/8-14	1 1/16	7/8	1.50	38.1	2.97	75.4	Y		Y
T8-JCFX-0610	34400-0610	20244012	3/8	9.5	7/8-14	1 1/16	7/8	1.50	38.1	2.97	75.4		Y	
T7-JCFX-0808	32400-0808	20243932	1/2	12.7	3/4-16	15/16	7/8	1.62	41.3	3.16	80.2	Y		Y
T7-JCFX-0808S	32400-0808S	20296980	1/2	12.7	3/4-16	15/16	7/8	1.62	41.3	3.16	80.2	Y		Y
T8-JCFX-0808	34400-0808	20244006	1/2	12.7	3/4-16	15/16	7/8	1.62	41.3	3.16	80.2		Y	
T7-JCFX-0810	32400-0810	20244005	1/2	12.7	7/8-14	1 1/16	7/8	1.62	41.3	3.16	80.2	Y		Y
T8-JCFX-0810	34400-0810	20244004	1/2	12.7	7/8-14	1 1/16	7/8	1.62	41.3	3.16	80.2		Y	
T7-JCFX-0812	32400-0812	20243934	1/2	12.7	1 1/16-12	1 1/4	1 1/8	1.62	41.3	3.25	82.6	Y		Y
T8-JCFX-0812	34400-0812	20243935	1/2	12.7	1 1/16-12	1 1/4	1 1/8	1.62	41.3	3.25	82.6		Y	
T7-JCFX-1210	32400-1210	20244016	3/4	19.0	7/8-14	1 1/16	1 1/8	1.62	41.3	3.44	87.3	Y		
T7-JCFX-1212	32400-1212	20243992	3/4	19.0	1 1/16-12	1 1/4	1 1/8	1.62	41.3	3.44	87.3	Y		
T7-JCFX-1216	32400-1216	20244019	3/4	19.0	1 5/16-12	1 1/2	1 1/8	1.69	42.9	3.50	88.9	Y		
T7-JCFX-1616	32400-1616	20243933	1	25.4	1 5/16-12	1 1/2	1 1/8	1.69	42.9	4.06	103.2	Y		

S: Stainless Steel

# JIC 37° Flare (SAE J514)

Female | 45° Elbow | Swivel

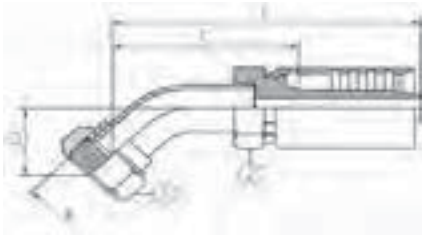

Descriptive #	Product #	SAP #	Hose Size ID		Thread Size (A)	Hex-1 Wrench Size	Hex-2 Wrench Size	Drop (D)		Cut-Off (C)		Length (L)		SR7, TR7, NR7, BR7	SR8, TR8, NR8	SR18
			in.	mm				in.	mm	in.	mm	in.	mm			
T7-JCFX45-0404	32420-0404	20243938	1/4	6.4	7/16-20	9/16	5/8	0.47	11.9	1.50	38.1	2.55	64.9	Y		Y
T8-JCFX45-0404	34420-0404	20243939	1/4	6.4	7/16-20	9/16	5/8	0.47	11.9	1.50	38.1	2.55	64.9		Y	
T7-JCFX45-0405	32420-0405	20243942	1/4	6.4	1/2-20	5/8	5/8	0.53	13.4	1.62	41.3	2.73	69.4	Y		Y
T8-JCFX45-0405	34420-0405	20243950	1/4	6.4	1/2-20	5/8	5/8	0.53	13.4	1.56	39.7	2.64	67.2		Y	
T7-JCFX45-0406	32420-0406	20243940	1/4	6.4	9/16-18	11/16	5/8	0.39	9.9	1.94	49.2	3.04	77.3	Y		Y
T8-JCFX45-0406	34420-0406	20243941	1/4	6.4	9/16-18	11/16	5/8	0.59	14.9	1.69	42.9	2.73	69.3		Y	
T7-JCFX45-0506	32420-0506	20243965	5/16	7.9	9/16-18	11/16	5/8	0.39	9.9	1.94	49.2	3.11	79.0	Y		Y
T7-JCFX45-0606	32420-0606	20243936	3/8	9.5	9/16-18	11/16	3/4	0.39	9.9	1.94	49.2	3.30	83.8	Y		Y
T8-JCFX45-0606	34420-0606	20243945	3/8	9.5	9/16-18	11/16	3/4	0.39	9.9	1.94	49.2	3.30	83.8		Y	
T7-JCFX45-0608	32420-0608	20243943	3/8	9.5	3/4-16	7/8	3/4	0.55	14.0	2.25	57.2	3.54	89.9	Y		Y
T8-JCFX45-0608	34420-0608	20243944	3/8	9.5	3/4-16	7/8	3/4	0.55	14.0	2.25	57.2	3.54	89.9		Y	
T7-JCFX45-0808	32420-0808	20243949	1/2	12.7	3/4-16	7/8	7/8	0.71	18.1	1.62	41.3	3.28	83.4	Y		Y
T8-JCFX45-0808	34420-0808	20243947	1/2	12.7	3/4-16	7/8	7/8	0.71	18.1	1.62	41.3	3.28	83.4		Y	
T7-JCFX45-0810	32420-0810	20243951	1/2	12.7	7/8-14	1	7/8	0.84	21.3	1.88	47.6	3.91	99.3	Y		Y
T8-JCFX45-0810	34420-0810	20243952	1/2	12.7	7/8-14	1	7/8	0.63	16.0	2.25	57.2	3.91	99.3		Y	
T7-JCFX45-1212	32420-1212	20243946	3/4	19.0	1 1/16-12	1 1/4	1 1/4	0.63	16.0	2.25	57.2	4.33	110.0	Y		
T7-JCFX45-1616	32420-1616	20243948	1	25.4	1 5/16-12	1 1/2	1 1/2	1.15	29.1	2.62	66.7	5.02	127.5	Y		



# JIC 37° Flare (SAE J514)

Female | 90° Elbow | Swivel

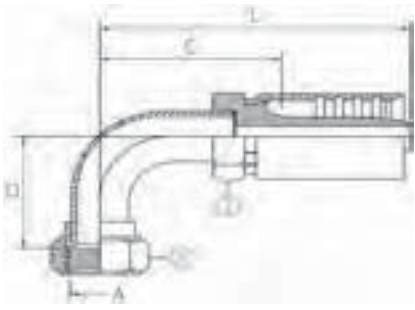

Elbow Type:  
LT=Long Tube  
ST=Short Tube

Descriptive #	Product #	SAP #	Hose Size ID		Thread Size (A)	Hex-1 Wrench Size	Hex-2 Wrench Size	Elbow Type	Drop (D)		Cut-Off (C)		Length (L)		SR7, TR7, NR7, BR7	SR8, TR8, NR8	SR18
			in.	mm					in.	mm	in.	mm	in.	mm			
T7-JCFX90-0404	32425-0404	20243919	1/4	6.4	7/16-20	9/16	5/8		0.68	17.3	1.69	42.9	2.76	70.0	Y		Y
T8-JCFX90-0404	34425-0404	20243931	1/4	6.4	7/16-20	9/16	5/8		0.68	17.3	1.69	42.9	2.76	70.0		Y	
T7-JCFX90L-0404	32440-0404	20243958	1/4	6.4	7/16-20	9/16	5/8	LT	1.80	45.7	1.25	31.8	2.31	58.7	Y		Y
T8-JCFX90L-0404	34440-0404	20243957	1/4	6.4	7/16-20	9/16	5/8	LT	1.80	45.7	1.25	31.8	2.31	58.7		Y	
T7-JCFX90-0405	32425-0405	20243929	1/4	6.4	1/2-20	5/8	5/8		1.00	25.4	1.31	33.3	2.38	60.3	Y		Y
T8-JCFX90-0405	34425-0405	20243930	1/4	6.4	1/2-20	5/8	5/8		1.00	25.4	1.31	33.3	2.38	60.3		Y	
T7-JCFX90L-0405	32440-0405	20243968	1/4	6.4	1/2-20	5/8	5/8	LT	1.77	45.0	1.30	32.9	2.38	60.3	Y		Y
T8-JCFX90L-0405	34440-0405	20243969	1/4	6.4	1/2-20	5/8	5/8	LT	1.77	45.0	1.31	33.3	2.38	60.3		Y	
T7-JCFX90-0406	32425-0406	20243927	1/4	6.4	9/16-18	11/16	5/8		1.12	28.6	1.94	49.2	3.25	82.6	Y		Y
T8-JCFX90-0406	34425-0406	20243916	1/4	6.4	9/16-18	11/16	5/8		1.12	28.6	1.31	33.3	2.41	61.1		Y	
T7-JCFX90L-0406	32440-0406	20243954	1/4	6.4	9/16-18	11/16	5/8	LT	2.18	55.4	1.19	30.2	2.44	61.9	Y		Y
T8-JCFX90L-0406	34440-0406	20243955	1/4	6.4	9/16-18	11/16	5/8	LT	2.18	55.4	1.19	30.2	2.44	61.9		Y	
T7-JCFX90-0505	32425-0505	20243922	5/16	7.9	1/2-20	5/8	5/8		1.00	25.4	1.12	28.6	2.38	60.3	Y		Y
T7-JCFX90-0506	32425-0506	20243937	5/16	7.9	9/16-18	11/16	5/8		0.85	21.6	1.88	47.6	3.06	77.7	Y		Y
T7-JCFX90L-0506	32440-0506	20243960	5/16	7.9	9/16-18	11/16	5/8	LT	2.18	55.4	1.19	30.2	2.44	61.9	Y		Y
T7-JCFX90-0606	32425-0606	20243920	3/8	9.5	9/16-18	11/16	3/4		0.85	21.6	1.94	49.2	3.25	82.6	Y		Y
T8-JCFX90-0606	34425-0606	20243921	3/8	9.5	9/16-18	11/16	3/4		0.85	21.6	1.94	49.2	3.25	82.6		Y	
T7-JCFX90L-0606	32440-0606	20243953	3/8	9.5	9/16-18	11/16	3/4	LT	2.18	55.4	1.94	49.2	3.24	82.3	Y		Y
T8-JCFX90L-0606	34440-0606	20243959	3/8	9.5	9/16-18	11/16	3/4	LT	2.18	55.4	1.94	49.2	3.24	82.3		Y	
T7-JCFX90-0608	32425-0608	20243923	3/8	9.5	3/4-16	7/8	3/4		1.09	27.7	2.00	50.8	3.34	84.8	Y		Y
T8-JCFX90-0608	34425-0608	20243918	3/8	9.5	3/4-16	7/8	3/4		1.09	27.7	2.00	50.8	3.34	84.8		Y	
T7-JCFX90L-0608	32440-0608	20243956	3/8	9.5	3/4-16	7/8	3/4	LT	2.43	61.7	1.31	33.3	2.75	69.9	Y		Y
T8-JCFX90L-0608	34440-0608	20243962	3/8	9.5	3/4-16	7/8	3/4	LT	2.43	61.7	1.31	33.3	2.75	69.9		Y	
T7-JCFX90-0808	32425-0808	20243925	1/2	12.7	3/4-16	7/8	7/8		1.09	27.7	1.94	49.2	3.53	89.7	Y		Y
T8-JCFX90-0808	34425-0808	20243926	1/2	12.7	3/4-16	7/8	7/8		1.09	27.7	1.94	49.2	3.53	89.7		Y	
T7-JCFX90L-0808	32440-0808	20243970	1/2	12.7	3/4-16	7/8	7/8	LT	2.43	61.7	1.31	33.3	2.94	74.6	Y		Y
T8-JCFX90L-0808	34440-0808	20243964	1/2	12.7	3/4-16	7/8	7/8	LT	2.43	61.7	1.31	33.3	2.94	74.6		Y	
T7-JCFX90-0810	32425-0810	20243924	1/2	12.7	7/8-14	1	7/8		1.23	31.2	2.19	55.6	3.74	95.0	Y		Y
T8-JCFX90-0810	34425-0810	20243928	1/2	12.7	7/8-14	1	7/8		1.23	31.2	2.19	55.6	3.74	95.0		Y	
T7-JCFX90L-0810	32440-0810	20243966	1/2	12.7	7/8-14	1	7/8	LT	2.57	65.3	2.19	55.6	3.77	95.8	Y		Y
T8-JCFX90L-0810	34440-0810	20243967	1/2	12.7	7/8-14	1	7/8	LT	2.57	65.3	2.19	55.6	3.77	95.8		Y	
T7-JCFX90-1212	32425-1212	20243917	3/4	19.0	1 1/16-12	1 1/4	1 1/8		2.31	58.7	2.06	52.4	3.88	98.4	Y		
T7-JCFX90-1616	32425-1616	20243961	1	25.4	1 5/16-12	1 1/2	1 3/8		2.50	63.5	2.94	74.6	4.75	120.7	Y		
T7-JCFX90L-1616	32440-1616	20243963	1	25.4	1 5/16-12	1 1/2	1 3/8	LT	4.33	110.0	2.31	58.7	4.69	119.1	Y		

# JIC 37° Flare (SAE J514)

Male

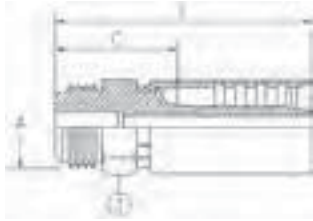

Descriptive #	Product #	SAP #	Hose Size ID		Thread Size (A)	Hex-1 Wrench Size	Cut-Off (C)		Length (L)		SR7, TR7, NR7, BR7	SR8, TR8, NR8	SR18
			in.	mm			in.	mm	in.	mm			
T7-JCM-0304	32450-0304	20243990	3/16	4.8	7/16-20	9/16	1.25	31.8	2.05	52.1	Y		
T8-JCM-0304	34450-0304	20243989	3/16	4.8	7/16-20	9/16	1.25	31.8	2.05	52.1		Y	
T7-JCM-0404	32450-0404	20243973	1/4	6.4	7/16-20	5/8	1.25	31.8	2.30	58.4	Y		Y
T8-JCM-0404	34450-0404	20243972	1/4	6.4	7/16-20	5/8	1.25	31.8	2.30	58.4		Y	
T7-JCM-0405	32450-0405	20243975	1/4	6.4	1/2-20	5/8	1.25	31.8	2.30	58.4	Y		Y
T8-JCM-0405	34450-0405	20243974	1/4	6.4	1/2-20	5/8	1.25	31.8	2.30	58.4		Y	
T7-JCM-0406	32450-0406	20243985	1/4	6.4	9/16-18	3/4	1.32	33.5	2.40	61.0	Y		Y
T8-JCM-0406	34450-0406	20243978	1/4	6.4	9/16-18	3/4	1.31	33.3	2.40	61.0		Y	
T7-JCM-0505	32450-0505	20243982	5/16	7.9	1/2-20	5/8	1.06	27.0	2.36	60.0	Y		Y
T7-JCM-0506	32450-0506	20243981	5/16	7.9	9/16-18	11/16	1.31	33.3	2.30	58.4	Y		Y
T7-JCM-0606	32450-0606	20243984	3/8	9.5	9/16-18	3/4	1.38	34.9	2.59	65.7	Y		Y
T8-JCM-0606	34450-0606	20243983	3/8	9.5	9/16-18	3/4	1.12	28.6	2.59	65.7		Y	
T7-JCM-0608	32450-0608	20243987	3/8	9.5	3/4-16	13/16	1.38	34.9	2.69	68.3	Y		Y
T8-JCM-0608	34450-0608	20243986	3/8	9.5	3/4-16	13/16	1.25	31.8	2.69	68.3		Y	
T7-JCM-0808	32450-0808	20243979	1/2	12.7	3/4-16	7/8	1.44	36.5	2.88	73.1	Y		Y
T8-JCM-0808	34450-0808	20243971	1/2	12.7	3/4-16	7/8	1.25	31.8	2.88	73.1		Y	
T7-JCM-0810	32450-0810	20243977	1/2	12.7	7/8-14	15/16	1.44	36.5	3.10	78.8	Y		Y
T8-JCM-0810	34450-0810	20243976	1/2	12.7	7/8-14	15/16	1.50	38.1	3.10	78.8		Y	
T7-JCM-1212	32450-1212	20243988	3/4	19.0	1 1/16-12	1 1/8	1.50	38.1	3.32	84.4	Y		
T7-JCM-1616	32450-1616	20243980	1	25.4	1 5/16-12	1 3/8	1.62	41.3	3.94	100.1	Y		

# SAE 45° J512 Flare

Female | Swivel



Descriptive #	Product #	SAP #	Hose Size ID		Thread Size (A)	Hex-1 Wrench Size	Hex-2 Wrench Size	Cut-Off (C)		Length (L)		SR7, TR7, NR7, BR7	SR8, TR8, NR8	SR18
			in.	mm				in.	mm	in.	mm			
T7-SFFX-0404	32775-0404	20244137	1/4	6.4	7/16-20	5/8	5/8	1.44	36.5	2.53	64.3	Y		Y
T8-SFFX-0404	34775-0404	20244136	1/4	6.4	7/16-20	5/8	5/8	1.45	36.7	2.53	64.3		Y	
T7-SFFX-0405	32775-0405	20244140	1/4	6.4	1/2-20	3/4	5/8	1.45	36.7	2.53	64.3	Y		Y
T8-SFFX-0405	34775-0405	20244139	1/4	6.4	1/2-20	3/4	5/8	1.45	36.7	2.53	64.3		Y	
T7-SFFX-0406	32775-0406	20244138	1/4	6.4	5/8-18	13/16	5/8	1.44	36.5	2.53	64.3	Y		Y
T8-SFFX-0406	34775-0406	20244145	1/4	6.4	5/8-18	13/16	5/8	1.44	36.5	2.53	64.3		Y	
T7-SFFX-0506	32775-0506	20244132	5/16	7.9	5/8-18	13/16	5/8	1.25	31.8	2.53	64.3	Y		Y
T7-SFFX-0606	32775-0606	20244134	3/8	9.5	5/8-18	13/16	3/4	1.38	34.9	2.81	71.5	Y		Y
T8-SFFX-0606	34775-0606	20244133	3/8	9.5	5/8-18	13/16	3/4	1.38	34.9	2.81	71.5		Y	
T7-SFFX-0808	32775-0808	20244142	1/2	12.7	3/4-16	15/16	7/8	1.66	42.1	3.15	80.0	Y		Y
T8-SFFX-0808	34775-0808	20244141	1/2	12.7	3/4-16	15/16	7/8	1.66	42.1	3.15	80.0		Y	
T7-SFFX-1212	32775-1212	20244135	3/4	19.0	1 1/16-14	1 1/4	1 1/8	1.62	41.3	3.44	87.3	Y		

# SAE 45° J512 Flare

Female | 90° Elbow | Swivel

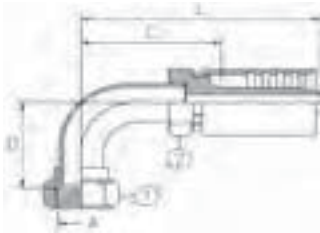

Descriptive #	Product #	SAP #	Hose Size ID		Thread Size (A)	Hex-1 Wrench Size	Hex-2 Wrench Size	Drop (D)		Cut-Off (C)		Length (L)		SR7, TR7, NR7, BR7	SR8, TR8, NR8	SR18
			in.	mm				in.	mm	in.	mm	in.	mm			
T7-SFFX90-0606	32780-0606	20244144	3/8	9.5	5/8-18	3/4	3/4	1.12	28.6	1.19	30.2	2.63	66.8	Y		Y
T8-SFFX90-0606	34780-0606	20244143	3/8	9.5	5/8-18	3/4	3/4	1.12	28.6	1.19	30.2	2.63	66.8		Y	

## SAE 45° Inverted Flare

Male | Swivel

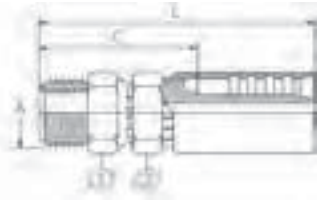

Descriptive #	Product #	SAP #	Hose Size ID		Thread Size (A)	Hex-1 Wrench Size	Hex-2 Wrench Size	Cut-Off (C)		Length (L)		SR7, TR7, NR7, BR7	SR8, TR8, NR8	SR18
			in.	mm				in.	mm	in.	mm			
T7-SIMX-0404	32800-0404	20244127	1/4	6.4	7/16-24	7/16	5/8	1.64	41.6	2.72	69.1	Y		Y
T7-SIMX-0405	32800-0405	20244128	1/4	6.4	1/2-20	1/2	5/8	1.69	42.9	2.78	70.6	Y		Y

## SAE 45° Inverted Flare

Male | 45° Elbow | Swivel

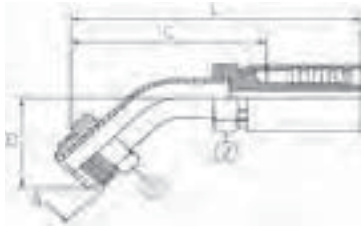

Descriptive #	Product #	SAP #	Hose Size ID		Thread Size (A)	Hex-1 Wrench Size	Hex-2 Wrench Size	Drop (D)	Cut-Off (C)		Length (L)		SR7, TR7, NR7, BR7	SR8, TR8, NR8	SR18
			in.	mm					in.	mm	in.	mm			
T8-SIMX45-0606	34810-0606	20244130	3/8	9.5	5/8-18	5/8	3/4	0.96	24.5	1.88	47.6	3.30	83.8	Y	

# SAE 45° Inverted Flare

Male | 90° Elbow | Swivel

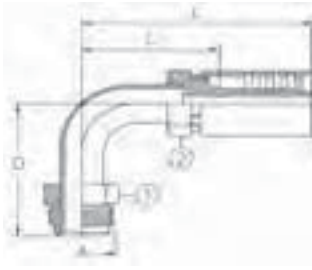

Descriptive #	Product #	SAP #	Hose Size ID		Thread Size (A)	Hex-1 Wrench Size	Hex-2 Wrench Size	Drop (D)		Cut-Off (C)		Length (L)		SR7, TR7, NR7, BR7	SR8, TR8, NR8	SR18
			in.	mm	in.	in.	in.	in.	mm	in.	mm	in.	mm			
T7-SIMX90-0404	32815-0404	20244129	1/4	6.4	7/16-24	7/16	9/16	1.31	33.3	1.23	31.3	2.31	58.7	Y		Y
T7-SIMX90-0606	32815-0606	20244131	3/8	9.5	5/8-18	5/8	3/4	1.66	42.2	1.19	30.2	2.62	66.7	Y		Y
T8-SIMX90-0606	34815-0606	20244126	3/8	9.5	5/8-18	5/8	3/4	1.66	42.2	1.19	30.2	2.63	66.8		Y	

# NPTF

Female

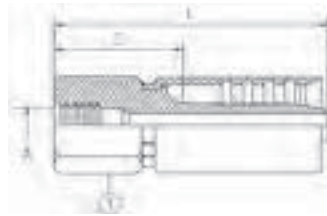

Descriptive #	Product #	SAP #	Hose Size ID		Thread Size (A)	Hex-1 Wrench Size	Cut-Off (C)		Length (L)		SR7, TR7, NR7, BR7	SR8, TR8, NR8	SR18
			in.	mm	in.	in.	mm	in.	mm				
T7-NPF-0404	32600-0404	20244060	1/4	6.4	1/4-18	3/4	1.25	31.8	2.34	59.5	Y		Y
T8-NPF-0404	34600-0404	20244059	1/4	6.4	1/4-18	3/4	1.25	31.8	2.34	59.5		Y	
T7-NPF-0604	32600-0604	20244058	3/8	9.5	1/4-18	3/4	1.06	27.0	2.53	64.3	Y		Y
T7-NPF-0606	32600-0606	20244057	3/8	9.5	3/8-18	7/8	1.19	30.2	2.63	66.7	Y		Y
T8-NPF-0606	34600-0606	20244056	3/8	9.5	3/8-18	7/8	1.19	30.2	2.63	66.7		Y	
T7-NPF-0808	32600-0808	20244062	1/2	12.7	1/2-14	1 1/16	1.31	33.3	3.03	77.0	Y		Y
T8-NPF-0808	34600-0808	20244061	1/2	12.7	1/2-14	1 1/16	1.31	33.3	3.03	77.0		Y	

# NPTF

Male

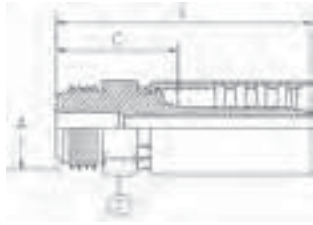

Fittings

Equipment & Accessories

Assemblies

Installation & Maintenance

Appendix

Descriptive #	Product #	SAP #	Hose Size ID		Thread Size (A)		Hex-1 Wrench Size		Cut-Off (C)		Length (L)		SR7, TR7, NR7, BR7	SR8, TR8, NR8	SR18
			in.	mm	in.	mm	in.	mm	in.	mm	in.	mm			
T7-NPM-0202	32615-0202	20244064	1/8	3.2	1/8-27	1/2	0.75	19.1	1.34	34.1	Y				
T7-NPM-0302	32615-0302	20244065	3/16	4.8	1/8-27	9/16	1.06	27.0	1.88	47.8	Y				
T8-NPM-0302	34615-0302	20244055	3/16	4.8	1/8-27	9/16	1.06	27.0	1.88	47.8		Y			
T7-NPM-0304	32615-0304	20244067	3/16	4.8	1/4-18	11/16	1.25	31.8	2.06	52.3	Y				
T8-NPM-0304	34615-0304	20244066	3/16	4.8	1/4-18	11/16	1.25	31.8	2.06	52.3		Y			
T7-NPM-0306	32615-0306	20244052	3/16	4.8	3/8-18	3/4	1.38	34.9	2.15	54.7	Y				
T8-NPM-0306	34615-0306	20244038	3/16	4.8	3/8-18	3/4	1.38	34.9	2.15	54.7		Y			
T7-NPM-0402	32615-0402	20244072	1/4	6.4	1/8-27	5/8	1.06	27.0	2.13	54.1	Y		Y		
T8-NPM-0402	34615-0402	20244071	1/4	6.4	1/8-27	5/8	1.06	27.0	2.13	54.1		Y			
T7-NPM-0404	32615-0404	20244078	1/4	6.4	1/4-18	11/16	1.25	31.8	2.31	58.7	Y		Y		
T8-NPM-0404	34615-0404	20244079	1/4	6.4	1/4-18	11/16	1.25	31.8	2.31	58.7		Y			
T8-NPM-0404S	34615-0404S	20435885	1/4	6.4	1/4-18	11/16	1.25	31.8	2.31	58.7		Y			
T7-NPM-0406	32615-0406	20244070	1/4	6.4	3/8-18	3/4	1.31	33.3	2.40	61.1	Y		Y		
T8-NPM-0406	34615-0406	20244069	1/4	6.4	3/8-18	3/4	1.31	33.3	2.40	61.1		Y			
T7-NPM-0408	32615-0408	20244076	1/4	6.4	1/2-14	15/16	1.56	39.7	2.66	67.5	Y		Y		
T8-NPM-0408	34615-0408	20244077	1/4	6.4	1/2-14	15/16	1.56	39.7	2.66	67.5		Y			
T7-NPM-0504	32615-0504	20244032	5/16	7.9	1/4-18	11/16	1.12	28.6	2.31	58.8	Y		Y		
T7-NPM-0604	32615-0604	20244033	3/8	9.5	1/4-18	3/4	1.31	33.3	2.59	65.8	Y		Y		
T8-NPM-0604	34615-0604	20244030	3/8	9.5	1/4-18	3/4	1.31	33.3	2.59	65.8		Y			
T7-NPM-0606	32615-0606	20244028	3/8	9.5	3/8-18	3/4	1.31	33.3	2.59	65.8	Y		Y		
T8-NPM-0606	34615-0606	20244029	3/8	9.5	3/8-18	3/4	1.31	33.3	2.59	65.8		Y			
T7-NPM-0608	32615-0608	20244031	3/8	9.5	1/2-14	15/16	1.56	39.7	2.84	72.2	Y		Y		
T8-NPM-0608	34615-0608	20244035	3/8	9.5	1/2-14	15/16	1.56	39.7	2.84	72.2		Y			
T7-NPM-0806	32615-0806	20244073	1/2	12.7	3/8-18	7/8	1.28	32.5	2.78	70.7	Y		Y		
T8-NPM-0806	34615-0806	20244075	1/2	12.7	3/8-18	7/8	1.25	31.8	2.78	70.7		Y			
T7-NPM-0808	32615-0808	20244054	1/2	12.7	1/2-14	15/16	1.50	38.1	3.03	77.0	Y		Y		
T8-NPM-0808	34615-0808	20244053	1/2	12.7	1/2-14	15/16	1.50	38.1	3.03	77.0		Y			
T7-NPM-0812	32615-0812	20244068	1/2	12.7	3/4-14	1 1/8	1.50	38.1	3.04	77.1	Y		Y		
T8-NPM-0812	34615-0812	20244074	1/2	12.7	3/4-14	1 1/8	1.50	38.1	3.09	78.6		Y			
T7-NPM-1208	32615-1208	20244037	3/4	19.0	1/2-14	1 1/8	1.44	36.5	3.22	81.8	Y				
T7-NPM-1212	32615-1212	20244036	3/4	19.0	3/4-14	1 1/8	1.38	34.9	3.22	81.8	Y				
T8-NPM-1212	34615-1212	20440323	3/4	19.0	3/4-14							Y			
T7-NPM-1616	32615-1616	20244063	1	25.4	1-11 1/2	1 3/8	1.62	41.3	3.97	100.8	Y				
T8-NPM-1616	34615-1616	20440324	1	25.4	1-11 1/2							Y			

S: Stainless Steel

# NPTF

Male | Swivel

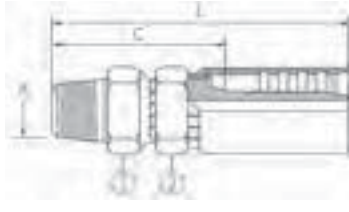

Descriptive #	Product #	SAP #	Hose Size ID		Thread Size (A)	Hex-1 Wrench Size	Hex-2 Wrench Size	Cut-Off (C)		Length (L)		SR7, TR7, NR7, BR7	SR8, TR8, NR8	SR18
			in.	mm		in.	in.	in.	mm	in.	mm			
T7-NPMX-0202	32645-0202	20598101	1/8	3.2	1/8-27	1/2	1/2	1.33	33.8	1.90	48.2	Y		
T7-NPMX-0304	32645-0304	20244047	3/16	4.8	1/4-18	11/16	5/8	1.81	46.0	2.64	67.0	Y		
T8-NPMX-0304	34645-0304	20244039	3/16	4.8	1/4-18	11/16	5/8	1.81	46.0	2.64	67.0		Y	
T7-NPMX-0404	32645-0404	20244050	1/4	6.4	1/4-18	11/16	5/8	1.81	46.0	2.87	73.0	Y		Y
T8-NPMX-0404	34645-0404	20244049	1/4	6.4	1/4-18	11/16	5/8	1.81	46.0	2.87	73.0		Y	
T7-NPMX-0406	32645-0406	20244048	1/4	6.4	3/8-18	3/4	5/8	1.93	49.0	3.02	76.7	Y		Y
T7-NPMX-0504	32645-0504	20244040	5/16	7.9	1/4-18	11/16	5/8	1.62	41.3	2.87	73.0	Y		Y
T7-NPMX-0606	32645-0606	20244042	3/8	9.5	3/8-18	3/4	3/4	1.69	42.9	3.15	80.0	Y		Y
T8-NPMX-0606	34645-0606	20244041	3/8	9.5	3/8-18	3/4	3/4	1.69	42.9	3.15	80.0		Y	
T7-NPMX-0608	32645-0608	20244044	3/8	9.5	1/2-14	7/8	3/4	1.88	47.6	3.38	85.7	Y		Y
T8-NPMX-0608	34645-0608	20244043	3/8	9.5	1/2-14	7/8	3/4	1.88	47.6	3.31	84.2		Y	
T7-NPMX-0808	32645-0808	20244045	1/2	12.7	1/2-14	15/16	7/8	1.94	49.2	3.61	91.7	Y		Y
T8-NPMX-0808	34645-0808	20244051	1/2	12.7	1/2-14	15/16	7/8	1.94	49.2	3.61	91.7		Y	
T7-NPMX-1212	32645-1212	20244046	3/4	19.0	3/4-14	1 1/8	1 1/8	2.00	50.8	3.84	97.5	Y		
T7-NPMX-1616	32645-1616	20244034	1	25.4	1-11 1/2	1 1/2	1 1/2	2.31	58.7	4.65	118.1	Y		

# NPSM

Female | Swivel

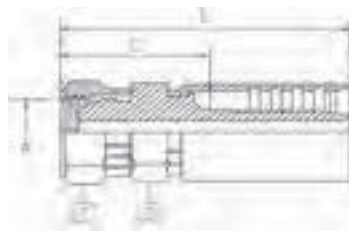

Descriptive #	Product #	SAP #	Hose Size ID		Thread Size (A)	Hex-1 Wrench Size	Hex-2 Wrench Size	Cut-Off (C)		Length (L)		SR7, TR7, NR7, BR7	SR8, TR8, NR8	SR18
			in.	mm		in.	in.	in.	mm	in.	mm			
T7-NSFX-0808	32655-0808	20244026	1/2	12.7	1/2-14	1	1	1.38	34.9	3.06	77.8	Y		Y
T8-NSFX-0808	34655-0808	20244027	1/2	12.7	1/2-14	1	1	1.38	34.9	3.06	77.8		Y	

## SAE J514 Flareless Tube Fittings

Male

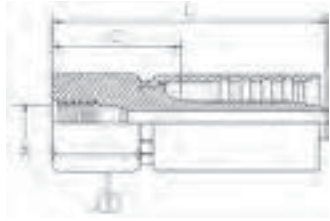

Descriptive #	Product #	SAP #	Hose Size ID		Thread Size (A)	Hex-1 Wrench Size	Cut-Off (C)		Length (L)		SR7, TR7, NR7, BR7	SR8, TR8, NR8	SR18
			in.	mm	in.	in.	mm	in.	mm				
T7-FTM-0606	32360-0606	20244148	3/8	9.5	9/16-18	3/4	1.06	27.0	2.50	63.4	Y		Y
T8-FTM-0606	34360-0606	20244147	3/8	9.5	9/16-18	3/4	1.06	26.9	2.50	63.5		Y	
T7-FTM-0808	32360-0808	20244146	1/2	12.7	3/4-16	7/8	1.16	29.4	2.78	70.6	Y		Y

## Standpipe

45° Elbow

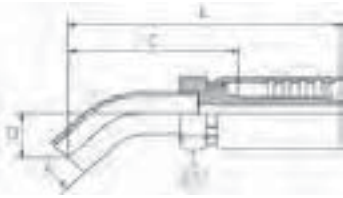

Descriptive #	Product #	SAP #	Hose Size ID		Thread Size (A)	Hex-1 Wrench Size	Drop (D)		Cut-Off (C)		Length (L)		SR7, TR7, NR7, BR7	SR8, TR8, NR8	SR18
			in.	mm	in.	in.	mm	in.	mm	in.	mm				
T7-SP45-0408	32830-0408	20244149	1/4	6.4	8	5/8	0.75	19.0	1.77	45.0	2.80	71.0	Y		Y
T8-SP45-0408	34830-0408	20244150	1/4	6.4	8	5/8	0.75	19.0	1.77	45.0	2.80	71.0		Y	



## O-Ring Face Seal (SAE J1453 ORS/ORFS)

Female | Swivel

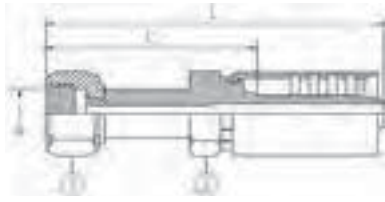

Descriptive #	Product #	SAP #	Hose Size ID		Thread Size (A)	Hex-1 Wrench Size	Hex-2 Wrench Size	Cut-Off (C)		Length (L)		SR7, TR7, NR7, BR7	SR8, TR8, NR8	SR18
			in.	mm	in.	in.	in.	mm	in.	mm	in.	mm		
T7-OFFX-0404	32700-0404	20244101	1/4	6.4	9/16-18	11/16	5/8	1.50	38.1	2.60	66.0	Y		Y
T8-OFFX-0404	34700-0404	20244105	1/4	6.4	9/16-18	11/16	5/8	1.50	38.1	2.60	66.0		Y	
T7-OFFX-0506	32700-0506	20244108	5/16	7.9	11/16-16	13/16	5/8	1.56	39.7	2.74	69.7	Y		Y
T7-OFFX-0606	32700-0606	20244103	3/8	9.5	11/16-16	7/8	3/4	1.44	36.5	2.75	69.9	Y		Y
T8-OFFX-0606	34700-0606	20244106	3/8	9.5	11/16-16	7/8	3/4	1.44	36.5	2.75	69.9		Y	
T7-OFFX-0608	32700-0608	20244107	3/8	9.5	13/16-16	15/16	3/4	1.88	47.6	3.22	81.8	Y		Y
T7-OFFX-0808	32700-0808	20244097	1/2	12.7	13/16-16	15/16	7/8	1.56	39.7	3.12	79.4	Y		Y
T8-OFFX-0808	34700-0808	20244098	1/2	12.7	13/16-16	15/16	7/8	1.69	42.9	3.28	83.4		Y	
T8-OFFX-0810	34700-0810	20244096	1/2	12.7	1-14	1 1/8	7/8	1.88	47.6	3.39	86.1		Y	
T7-OFFX-1212	32700-1212	20244104	3/4	19.0	1 1/16-12	1 1/8	1 1/8	2.12	54.0	3.88	98.7	Y		
T7-OFFX-1616	32700-1616	20244095	1	25.4	1 1/16-12	1 1/8	1 1/8	2.12	54.0	4.36	110.7	Y		

## O-Ring Face Seal (SAE J1453 ORS/ORFS)

Female | 45° Elbow | Swivel

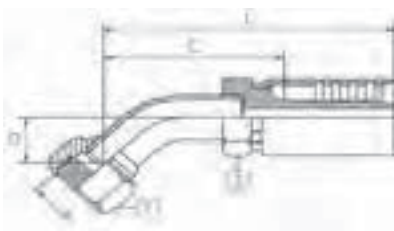

Descriptive #	Product #	SAP #	Hose Size ID		Thread Size (A)	Hex-1 Wrench Size	Hex-2 Wrench Size	Drop (D)		Cut-Off (C)		Length (L)		SR7, TR7, NR7, BR7	SR8, TR8, NR8	SR18
			in.	mm	in.	in.	in.	mm	in.	mm	in.	mm	in.	mm		
T7-OFFX45-0404	32710-0404	20244116	1/4	6.4	9/16-18	11/16	5/8	0.41	10.4	1.50	38.1	2.55	64.8	Y		Y
T8-OFFX45-0404	34710-0404	20244117	1/4	6.4	9/16-18	11/16	5/8	0.41	10.4	1.50	38.1	2.55	64.8		Y	
T7-OFFX45-0506	32710-0506	20244111	5/16	7.9	11/16-16	13/16	5/8	0.43	10.9	1.50	38.1	2.63	66.9	Y		Y
T7-OFFX45-0606	32710-0606	20244109	3/8	9.5	11/16-16	13/16	3/4	0.43	10.9	1.50	38.1	2.82	71.8	Y		Y
T8-OFFX45-0606	34710-0606	20244110	3/8	9.5	11/16-16	13/16	3/4	0.43	10.9	1.50	38.1	2.82	71.8		Y	
T7-OFFX45-0608	32710-0608	20268564	3/8	9.5	13/16-16	15/16	3/4	0.47	11.9	1.65	41.9	3.12	79.2	Y		Y
T7-OFFX45-0808	32710-0808	20244115	1/2	12.7	13/16-16	15/16	7/8	0.59	15.0	1.75	44.5	3.32	84.2	Y		Y
T8-OFFX45-0808	34710-0808	20244114	1/2	12.7	13/16-16	15/16	7/8	0.59	15.0	1.75	44.5	3.32	84.2		Y	

# O-Ring Face Seal (SAE J1453 ORS/ORFS)

Female | 90° Elbow | Swivel

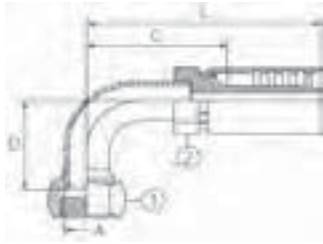

Elbow Type:  
LT=Long Tube  
ST=Short Tube

Descriptive #	Product #	SAP #	Hose Size ID		Thread Size (A)	Hex-1 Wrench Size	Hex-2 Wrench Size	Elbow Type	Drop (D)		Cut-Off (C)		Length (L)		SR7, TR7, NR7, BR7	SR8, TR8, NR8	SR18
			in.	mm	in.	in.	in.		mm	in.	mm	in.	mm	in.	mm		
T7-OFFX90-0404	32715-0404	20244118	1/4	6.4	9/16-18	11/16	5/8		0.78	19.8	1.25	31.8	2.31	58.8	Y		Y
T8-OFFX90-0404	34715-0404	20244123	1/4	6.4	9/16-18	11/16	5/8		0.78	19.8	1.25	31.8	2.31	58.8		Y	
T7-OFFX90-0506	32715-0506	20244100	5/16	7.9	11/16-16	13/16	3/4		0.90	22.9	1.94	49.2	3.10	78.7	Y		Y
T7-OFFX90-0606	32715-0606	20244119	3/8	9.5	11/16-16	13/16	3/4		0.90	22.9	2.00	50.8	3.30	83.8	Y		Y
T8-OFFX90-0606	34715-0606	20244120	3/8	9.5	11/16-16	13/16	3/4		0.90	22.9	2.00	50.8	3.30	83.8		Y	
T7-OFFX90L-0606	32720-0606	20244121	3/8	9.5	11/16-16	13/16	3/4	LT	2.13	54.1	1.44	36.5	2.74	69.6	Y		Y
T8-OFFX90L-0606	34720-0606	20244122	3/8	9.5	11/16-16	13/16	3/4	LT	2.13	54.1	1.44	36.5	2.74	69.6		Y	
T7-OFFX90-0808	32715-0808	20244124	1/2	12.7	13/16-16	15/16	7/8		1.15	29.2	1.50	38.1	3.04	77.3	Y		Y
T8-OFFX90-0808	34715-0808	20244125	1/2	12.7	13/16-16	15/16	7/8		1.15	29.2	1.50	38.1	3.04	77.3		Y	
T7-OFFX90L-0808	32720-0808	20244112	1/2	12.7	13/16-16	15/16	7/8	LT	2.51	63.8	1.56	39.7	3.16	80.3	Y		Y
T8-OFFX90L-0808	34720-0808	20244113	1/2	12.7	13/16-16	15/16	7/8	LT	2.51	63.8	1.56	39.7	3.16	80.3		Y	
T7-OFFX90-1212	32715-1212	20244099	3/4	19.0	1 3/16-12	1 1/8	1 1/8		1.88	47.8	2.75	69.9	4.47	113.7	Y		

# O-Ring Face Seal (SAE J1453 ORS/ORFS)

Male

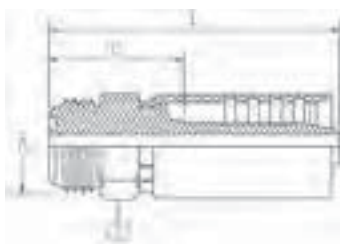

Descriptive #	Product #	SAP #	Hose Size ID		Thread Size (A)	Hex-1 Wrench Size	Cut-Off (C)		Length (L)		SR7, TR7, NR7, BR7	SR8, TR8, NR8	SR18
			in.	mm	in.	in.	mm	in.	mm				
T7-OFM-0404	32730-0404	20244102	1/4	6.4	9/16-18	5/8	1.06	27.0	2.13	54.1	Y		Y

## O-Ring Boss Straight Thread (SAE J514)

Male

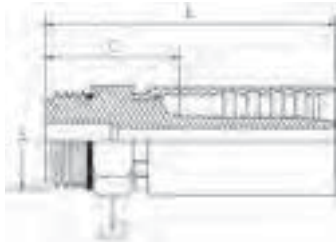

Descriptive #	Product #	SAP #	Hose Size ID		Thread Size (A)	Hex-1 Wrench Size	Cut-Off (C)		Length (L)		SR7, TR7, NR7, BR7	SR8, TR8, NR8	SR18
			in.	mm			in.	mm	in.	mm			
T7-OBM-0406	32670-0406	20244092	1/4	6.4	9/16-18	11/16	1.06	27.0	2.14	54.4	Y		Y
T8-OBM-0406	34670-0406	20244093	1/4	6.4	9/16-18	11/16	1.06	27.0	2.14	54.4		Y	
T7-OBM-0606	32670-0606	20244083	3/8	9.5	9/16-18	3/4	1.00	25.4	2.42	61.5	Y		Y
T8-OBM-0606	34670-0606	20244084	3/8	9.5	9/16-18	3/4	1.00	25.4	2.42	61.5		Y	
T7-OBM-0608	32670-0608	20244081	3/8	9.5	3/4-16	7/8	1.03	26.2	2.47	62.7	Y		Y
T8-OBM-0608	34670-0608	20244082	3/8	9.5	3/4-16	7/8	1.03	26.2	2.47	62.7		Y	
T7-OBM-0808	32670-0808	20244090	1/2	12.7	3/4-16	15/16	1.09	27.8	2.78	70.7	Y		Y
T8-OBM-0808	34670-0808	20244091	1/2	12.7	3/4-16	15/16	1.09	27.8	2.78	70.7		Y	

## O-Ring Boss Straight Thread (SAE J514)

Male | Swivel

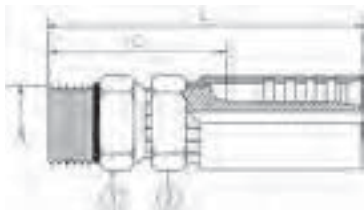

Descriptive #	Product #	SAP #	Hose Size ID		Thread Size (A)	Hex-1 Wrench Size	Hex-2 Wrench Size	Cut-Off (C)		Length (L)		SR7, TR7, NR7, BR7	SR8, TR8, NR8	SR18
			in.	mm				in.	mm	in.	mm			
T7-OBMX-0606	32680-0606	20244080	3/8	9.5	9/16-18	3/4	3/4	1.50	38.1	2.97	75.4	Y		Y
T8-OBMX-0606	34680-0606	20244086	3/8	9.5	9/16-18	3/4	3/4	1.50	38.1	2.97	75.4		Y	

# O-Ring Boss Straight Thread (SAE J514)

Male | 90° Elbow (Block) | Swivel

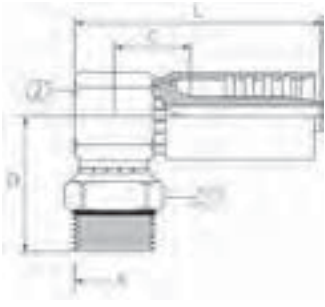

Elbow Type:  
BE=Block Elbow

Descriptive #	Product #	SAP #	Hose Size ID		Thread Size (A)		Hex-1 Wrench Size		Hex-2 Wrench Size		Elbow Type		Drop (D)		Cut-Off (C)		Length (L)		SR7, TR7, NR7, BR7	SR8, TR8, NR8	SR18
			in.	mm	in.	mm	in.	mm	in.	mm	in.	mm	in.	mm	in.	mm	in.	mm	Y	Y	Y
T7-OBMX90B-0608	32685-0608	20244088	3/8	9.5	3/4-16	7/8	13/16	BE	1.11	28.1	0.88	22.2	2.63	66.8	Y						Y
T8-OBMX90B-0608	34685-0608	20244094	3/8	9.5	3/4-16	7/8	13/16	BE	1.11	28.1	0.88	22.2	2.63	66.8						Y	

# BSPB (British Standard Pipe Parallel)

Female | Swivel

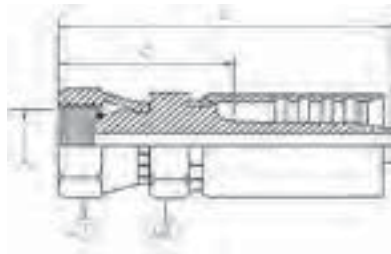

Descriptive #	Product #	SAP #	Hose Size ID		Thread Size (A)		Hex-1 Wrench Size		Hex-2 Wrench Size		Cut-Off (C)		Length (L)		SR7, TR7, NR7, BR7	SR8, TR8, NR8	SR18
			in.	mm	in.	mm	in.	mm	in.	mm	in.	mm	in.	mm	Y	Y	Y
T7-BPFX-0404	32105-0404	20243906	1/4	6.4	1/4-19	3/4	19	9/16	14	1.29	32.8	2.31	58.8	Y			Y
T8-BPFX-0404	34105-0404	20243903	1/4	6.4	1/4-19	3/4	19	9/16	14	1.29	32.8	2.31	58.8		Y		
T7-BPFX-0606	32105-0606	20243907	3/8	9.5	3/8-19	7/8	22	11/16	17	1.41	35.8	2.67	67.8	Y			Y
T8-BPFX-0606	34105-0606	20243908	3/8	9.5	3/8-19	7/8	22	11/16	17	1.41	35.8	2.67	67.8		Y		
T7-BPFX-0608	32105-0608	20243902	3/8	9.5	1/2-14	1 1/16	27	11/16	18	1.59	40.5	2.85	72.5	Y			Y
T8-BPFX-0608	34105-0608	20243901	3/8	9.5	1/2-14	1 1/16	27	11/16	18	1.59	40.5	2.85	72.5		Y		
T7-BPFX-0806	32105-0806	20243904	1/2	12.7	5/8-14	7/8	22	1 1/4	22	1.74	44.1	3.23	82.1	Y			Y
T8-BPFX-0806	34105-0806	20243900	1/2	12.7	5/8-14	7/8	22	1 1/4	22	1.74	44.1	3.23	82.1		Y		
T7-BPFX-0808	32105-0808	20243909	1/2	12.7	1/2-14	1 1/16	27	1 1/4	22	1.55	39.4	3.05	77.4	Y			Y
T8-BPFX-0808	34105-0808	20243905	1/2	12.7	1/2-14	1 1/16	27	1 1/4	22	1.55	39.4	3.05	77.4		Y		
T7-BPFX-1616	32105-1616	20243910	1	25.4	1-11	1 3/8	41	1 7/16	36	1.76	44.7	4.00	101.7	Y			

## BSPB (British Standard Pipe Parallel)

Female | 90° Elbow | Swivel

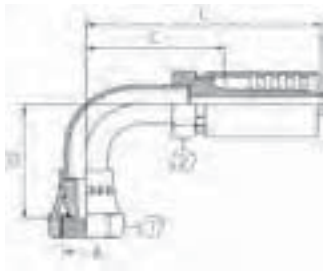

Descriptive #	Product #	SAP #	Hose Size ID		Thread Size (A)		Hex-1 Wrench Size		Hex-2 Wrench Size		Drop (D)		Cut-Off (C)		Length (L)		SR7, TR7, NR7, BR7	SR8, TR8, NR8	SR18
			in.	mm	in.	mm	in.	mm	in.	mm	in.	mm	in.	mm	in.	mm			
T7-BPFX90-0606	32120-0606	20243911	3/8	9.5	3/8-19	7/8	22	11/16	17	1.50	38.0	1.57	40.0	2.83	72.0	Y		Y	
T8-BPFX90-0606	34120-0606	20243914	3/8	9.5	3/8-19	7/8	22	11/16	17	1.50	38.0	1.57	40.0	2.83	72.0		Y		
T7-BPFX90-0808	32120-0808	20243913	1/2	12.7	1/2-14	1 1/16	27	7/8	22	1.67	42.5	1.65	42.0	3.15	80.0	Y		Y	
T8-BPFX90-0808	34120-0808	20243912	1/2	12.7	1/2-14	1 1/16	27	7/8	22	1.67	42.5	1.65	42.0	3.15	80.0		Y		

## DIN 60°

Female | 90° Elbow | Swivel

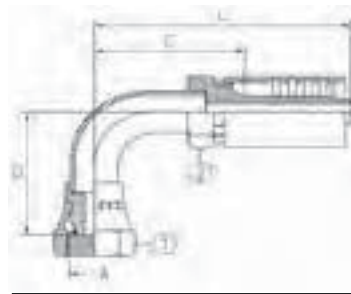

Descriptive #	Product #	SAP #	Hose Size ID		Thread Size (A)		Hex-1 Wrench Size		Hex-2 Wrench Size		Drop (D)		Cut-Off (C)		Length (L)		SR7, TR7, NR7, BR7	SR8, TR8, NR8	SR18
			in.	mm	in.	mm	in.	mm	in.	mm	in.	mm	in.	mm	in.	mm			
T8-DNFX90-0418	34280-0418	20243915	1/4	6.4	18x1 1/2	22		17		1.40	35.5	1.30	33.0	2.32	59.0		Y		

## JIS 30° (Parallel Pipe Threads)

Female | Swivel

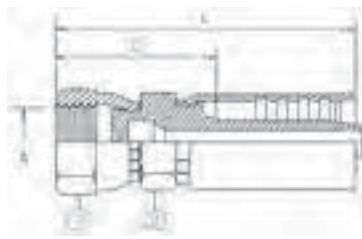

Descriptive #	Product #	SAP #	Hose Size ID		Thread Size (A)		Hex-1 Wrench Size		Hex-2 Wrench Size		Cut-Off (C)		Length (L)		SR7, TR7, NR7, BR7	SR8, TR8, NR8	SR18
			in.	mm	in.	mm	in.	mm	in.	mm	in.	mm	in.	mm			
T7-JSFX-0404	32520-0404	20244023	1/4	6.4	1/4-19	3/4	19	13/16	19	1.38	34.9	2.46	62.6	Y		Y	
T8-JSFX-0404	34520-0404	20244020	1/4	6.4	1/4-19	3/4	19	13/16	19	1.38	34.9	2.46	62.6		Y		
T7-JSFX-0606	32520-0606	20244022	3/8	9.5	3/8-19	7/8	22	7/8	22	1.56	39.7	2.82	71.6	Y		Y	
T8-JSFX-0606	34520-0606	20244021	3/8	9.5	3/8-19	7/8	22	7/8	22	1.56	39.7	2.82	71.6		Y		
T7-JSFX-0808	32520-0808	20244025	1/2	12.7	1/2-14	1 1/16	27	7/8	22	1.69	42.9	3.32	84.4	Y		Y	
T8-JSFX-0808	34520-0808	20244024	1/2	12.7	1/2-14	1 1/16	27	7/8	22	1.69	42.9	3.32	84.4		Y		

# How to Use the Fitting Tables

This section lists ALL fittings that are compatible with the following hoses:

Hose Family	Hose Description
SR12	SAE 100R12/EN 856 R12
ARC12	SAE 100R12/EN 856 R12 (Abrasion Cover)

## Fitting Description

Fitting Type



S=Skive  
NS=Non-Skive  
DG=Dual-Grip™

Descriptive #	Product #	SAP #	Hose Size ID		Thread Size (A)		Hex-1 Wrench Size		Cut-Off (C)		Length (L)		Skive Type	SR12, ARC12
			in.	mm	in.	mm	in.	mm	in.	mm				
Ultra-Crimp, PN1	28645-0606	20242080	3/8	9.5	3/8-18	7/8	22	1.48	37.5	2.53	64.2	NS	Y	
Ultra-Crimp, PN2	28645-0808	20242089	1/2	12.7	1/2-14	1	25	1.67	42.3	2.91	73.8	NS		
Uni-Crimp, PN3	28645-1212	20242084	3/4	19.0	3/4-14	1 1/4	32	1.97	50.1	3.53	89.6	NS	Uni-Crimp Ferrule PN	

Choose fittings carefully, considering the working pressure of both hose and fitting. The maximum working pressure of the hose assembly is the lesser of the rated working pressure of the hose and the fitting. See page 300 for working pressure.

A **Part Number (Ferrule)** in the hose compatibility columns indicates that the fitting is a **Uni-Crimp™** or **Dual-Grip™** style. The fitting, along with the Ferrule shown, work together as a unit for that particular hose.

A **“Y”** in the hose compatibility columns indicates that the fitting is an **Ultra-Crimp™** style fitting and that it works for that particular hose.

A **blank space** in the hose compatibility columns indicates that the fitting **DOES NOT** work for that particular hose.

# JIC 37° Flare (SAE J514)

Female | Swivel

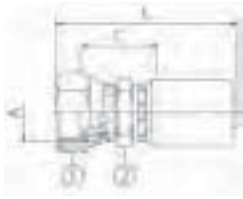

S=Skive  
NS=Non-Skive  
DG=Dual-Grip™

Descriptive #	Product #	SAP #	Hose Size ID		Thread Size (A)	Hex-1 Wrench Size		Hex-2 Wrench Size		Cut-Off (C)		Length (L)		Skive Type	SR12, ARC12
			in.	mm		in.	mm	in.	mm	in.	mm	in.	mm		
S4-JCFX-0606	28400-0606	20242039	3/8	9.5	9/16-18	3/4	19	11/16	17	0.84	21.3	2.26	57.5	NS	Y
S4-JCFX-0608	28400-0608	20242051	3/8	9.5	3/4-16	1	25	3/4	19	0.98	24.8	2.45	62.2	NS	Y
S4-JCFX-0806	28400-0806	20242033	1/2	12.7	9/16-18	3/4	19	3/4	19	0.91	23.1	2.52	64.1	NS	Y
S4-JCFX-0808	28400-0808	20241956	1/2	12.7	3/4-16	1	25	3/4	19	1.01	25.6	2.67	67.8	NS	Y
S4-JCFX-0808S	28400-0808S	20565523	1/2	12.7	3/4-16	1	25	3/4	19	1.01	25.6	2.67	67.8	NS	Y
S4-JCFX-0810	28400-0810	20242035	1/2	12.7	7/8-14	1 1/16	27	7/8	22	1.05	26.6	2.79	70.8	NS	Y
S4-JCFX-0812	28400-0812	20241926	1/2	12.7	1 1/16-12	1 1/4	32	1	25	1.11	28.1	2.91	73.9	NS	Y
S4-JCFX-1008	28400-1008	20449625	5/8	15.9	3/4-16	1	25	15/16	24	1.05	26.6	2.82	71.6	NS	Y
S4-JCFX-1010	28400-1010	20242003	5/8	15.9	7/8-14	1 1/16	27	15/16	24	1.09	27.6	2.94	74.6	NS	Y
S4-JCFX-1010S	28400-1010S	20424907	5/8	15.9	7/8-14	1 1/16	27	15/16	24	1.09	27.6	2.94	74.6	NS	Y
S4-JCFX-1012	28400-1012	20241989	5/8	15.9	1 1/16-12	1 1/4	32	1	25	1.11	28.1	3.02	76.7	NS	Y
S4-JCFX-1210	28400-1210	20242048	3/4	19.0	7/8-14	1 1/16	27	1 1/16	27	0.79	20.1	2.85	72.3	NS	Y
S4-JCFX-1212	28400-1212	20242030	3/4	19.0	1 1/16-12	1 1/4	32	1 1/16	27	1.13	28.6	3.24	82.4	NS	Y
S4-JCFX-1212S	28400-1212S	20424909	3/4	19.0	1 1/16-12	1 1/4	32	1 1/16	27	1.13	28.6	3.24	82.4	NS	Y
S4-JCFX-1214	28400-1214	20242045	3/4	19.0	1 3/16-12	1 1/16	36	1 1/4	32	0.78	19.9	2.92	74.1	NS	Y
S4-JCFX-1216	28400-1216	20242044	3/4	19.0	1 5/16-12	1 1/2	38	1 1/4	32	1.26	32.1	3.41	86.7	NS	Y
S4-JCFX-1612	28400-1612	20241937	1	25.4	1 1/16-12	1 1/4	32	1 1/4	32	1.24	31.4	3.56	90.3	NS	Y
S4-JCFX-1616	28400-1616	20241917	1	25.4	1 5/16-12	1 1/2	38	1 1/4	32	1.30	32.9	3.65	92.6	NS	Y
S4-JCFX-1616S	28400-1616S	20424920	1	25.4	1 5/16-12	1 1/2	38	1 1/4	32	1.30	32.9	3.65	92.6	NS	Y
S4-JCFX-1620T	28400-1620	20241920	1	25.4	1 7/8-12	2	50	1 7/8	41	1.48	37.5	3.86	98.0	NS	Y
S4-JCFX-2020T	28400-2020	20241915	1 1/4	31.8	1 7/8-12	2	50	1 7/8	41	1.54	39.1	4.21	107.0	NS	Y
S4-JCFX-2020S	28400-2020S	20289599	1 1/4	31.8	1 7/8-12	2	50	1 7/8	41	1.54	39.1	4.21	107.0	NS	Y
S4-JCFX-2024T	28400-2024	20293262	1 1/4	31.8	1 7/8-12	2 3/16	55	2	50	1.71	43.4	4.49	114.0	NS	Y
S4-JCFX-2424T	28400-2424	20241928	1 1/2	38.1	1 7/8-12	2 3/16	55	2	50	1.71	43.4	4.76	121.0	NS	Y
S4-JCFX-2424S	28400-2424S	20289598	1 1/2	38.1	1 7/8-12	2 3/16	55	2	50	1.71	43.4	4.76	121.0	NS	Y
S4-JCFX-3232T	28400-3232	20242028	2	50.8	2 1/2-12	2 3/4	70	2 9/16	65	1.93	49.0	5.71	145.0	NS	Y
S4-JCFX-3232S	28400-3232S	20739385	2	50.8	2 1/2-12	2 3/4	70	2 9/16	65	1.93	49.0	5.71	145.0	NS	Y

Descriptive #	Product #	SAP #	Hose Size ID		Thread Size (A)	Hex-1 Wrench Size		Hex-2 Wrench Size		Cut-Off (C)		Length (L)		Skive Type	SR12, ARC12
			in.	mm		in.	mm	in.	mm	in.	mm				
SG-JCFX-0604	29400-0604	20822056	3/8	9.5	7/16-20	5/8	16	11/16	17	1.27	32.2	2.73	69.2	NS	Y
SG-JCFX-0606	29400-0606	20758248	3/8	9.5	9/16-18	3/4	19	11/16	17	1.32	33.6	2.78	70.6	NS	Y
SG-JCFX-0606S	29400-0606S	20822055	3/8	9.5	9/16-18	3/4	19	11/16	17	1.32	33.6	2.78	70.6	NS	Y
SG-JCFX-0608	29400-0608	20758284	3/8	9.5	3/4-16	1	25	3/4	19	1.09	27.7	2.55	64.7	NS	Y
SG-JCFX-0610	29400-0610	20822054	3/8	9.5	7/8-14	1 1/16	27	7/8	22	1.63	41.4	3.09	78.5	NS	Y

T: Thrust-Wire Nut (See "Fitting Identification" in Appendix for details) S: Stainless Steel

Continued on next page

# JIC 37° Flare (SAE J514)

## Female | Swivel Continued

Descriptive #	Product #	SAP #	Hose Size ID		Thread Size (A)	Hex-1 Wrench Size		Hex-2 Wrench Size		Cut-Off (C)		Length (L)		Skive Type	SR12, ARC12
			in.	mm		in.	mm	in.	mm	in.	mm	in.	mm		
SG-JCFX-0806	29400-0806	20822053	1/2	12.7	9/16-18	3/4	19	3/4	19	1.36	34.6	2.90	73.6	NS	Y
SG-JCFX-0808	29400-0808	20753008	1/2	12.7	3/4-16	1	25	3/4	19	1.09	27.7	2.63	66.7	NS	Y
SG-JCFX-0808S	29400-0808S	20822052	1/2	12.7	3/4-16	1	25	3/4	19	1.09	27.7	2.63	66.7	NS	Y
SG-JCFX-0810	29400-0810	20758294	1/2	12.7	7/8-14	1 1/16	27	7/8	22	1.64	41.6	3.17	80.6	NS	Y
SG-JCFX-0812T	29400-0812	20758299	1/2	12.7	1 1/16-12	1 1/4	32	1	25	1.74	44.2	3.28	83.2	NS	Y
SG-JCFX-1008	29400-1008	20822051	5/8	15.9	3/4-16	1	25	15/16	24	1.65	41.9	3.24	82.3	NS	Y
SG-JCFX-1010	29400-1010	20822050	5/8	15.9	7/8-14	1 1/16	27	15/16	24	1.76	44.8	3.36	85.3	NS	Y
SG-JCFX-1010S	29400-1010S	20822049	5/8	15.9	7/8-14	1 1/16	27	15/16	24	1.76	44.8	3.36	85.3	NS	Y
SG-JCFX-1012T	29400-1012	20822048	5/8	15.9	1 1/16-12	1 1/4	32	1	25	1.76	44.7	3.35	85.2	NS	Y
SG-JCFX-1210	29400-1210	20822047	3/4	19.0	7/8-14	1 1/16	27	1 1/16	27	1.74	44.2	3.61	91.7	NS	Y
SG-JCFX-1212T	29400-1212	20822046	3/4	19.0	1 1/16-12	1 1/4	32	1 1/16	27	1.80	45.7	3.67	93.2	NS	Y
SG-JCFX-1212S	29400-1212S	20822045	3/4	19.0	1 1/16-12	1 1/4	32	1 1/16	27	1.80	45.7	3.67	93.2	NS	Y
SG-JCFX-1214	29400-1214	20822044	3/4	19.0	1 3/16-12	1 1/2	36	1 1/4	32	1.87	47.5	3.74	95.0	NS	Y
SG-JCFX-1216T	29400-1216	20822043	3/4	19.0	1 5/16-12	1 1/2	38	1 1/4	32	1.46	37.1	3.33	84.6	NS	Y
SG-JCFX-1612T	29400-1612	20822042	1	25.4	1 1/16-12	1 1/4	32	1 1/4	32	1.42	36.1	3.71	94.1	NS	Y
SG-JCFX-1616T	29400-1616	20822041	1	25.4	1 5/16-12	1 1/2	38	1 1/4	32	2.12	53.7	4.40	111.7	NS	Y
SG-JCFX-1616S	29400-1616S	20822040	1	25.4	1 5/16-12	1 1/2	38	1 1/4	32	2.12	53.7	4.40	111.7	NS	Y
SG-JCFX-1620T	29400-1620	20822039	1	25.4	1 1/2-12	2	50	1 1/2	41	1.62	41.1	3.90	99.1	NS	Y

T: Thrust-Wire Nut (see "Fitting Identification" in Appendix for details)

S: Stainless Steel

# JIC 37° Flare (SAE J514)

## Female | 45° Elbow | Swivel

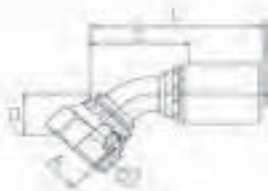

S=Skive  
NS=Non-Skive  
DG=Dual-Grip™

Descriptive #	Product #	SAP #	Hose Size ID		Thread Size (A)	Hex-1 Wrench Size		Drop (D)		Cut-Off (C)		Length (L)		Skive Type	SR12, ARC12
			in.	mm		in.	mm	in.	mm	in.	mm	in.	mm		
S4-JCFX45-0606	28420-0606	20241969	3/8	9.5	9/16-18	3/4	19	0.43	11.0	1.81	46.0	2.87	73.0	NS	Y
S4-JCFX45-0608	28420-0608	20241955	3/8	9.5	3/4-16	1	25	0.59	15.0	1.85	47.0	2.91	74.0	NS	Y
S4-JCFX45-0808	28420-0808	20241964	1/2	12.7	3/4-16	1	25	0.59	15.0	2.05	52.0	3.27	83.0	NS	Y
S4-JCFX45-0810	28420-0810	20241966	1/2	12.7	7/8-14	1 1/16	27	0.63	16.0	2.01	51.0	3.23	82.0	NS	Y
S4-JCFX45-1010	28420-1010	20428863	5/8	15.9	7/8-14	1 1/16	27	0.75	19.0	2.44	62.0	3.78	96.0	NS	Y
S4-JCFX45-1212	28420-1212	20241947	3/4	19.0	1 1/16-12	1 1/4	32	0.83	21.0	2.64	67.0	4.21	107.0	NS	Y
S4-JCFX45-1616	28420-1616	20241958	1	25.4	1 5/16-12	1 1/2	38	0.94	24.0	3.11	79.0	4.88	124.0	NS	Y
S4-JCFX45-1616S	28423-1616	20241981	1	25.4	1 5/16-12	1 1/2	38	0.94	24.0	3.11	79.0	4.88	124.0	NS	Y
S4-JCFX45-1620	28420-1620	20293259	1	25.4	1 1/2-12	2	50	1.46	37.0	3.37	85.5	5.47	139.0	NS	Y
S4-JCFX45-2020T	28420-2020	20241961	1 1/4	31.8	1 1/2-12	2	50	1.46	37.0	3.82	97.0	6.18	157.0	NS	Y
S4-JCFX45-2424T	28420-2424	20241960	1 1/2	38.1	1 1/2-12	2 3/16	55	1.69	43.0	4.45	113.0	7.15	181.5	NS	Y

T: Thrust-Wire Nut (see "Fitting Identification" in Appendix for details)

Continued on next page



# JIC 37° Flare (SAE J514)

Female | 45° Elbow | Swivel Continued

Descriptive #	Product #	SAP #	Hose Size ID		Thread Size (A)	Hex-1 Wrench Size		Hex-2 Wrench Size		Cut-Off (C)		Length (L)		Skive Type	SR12, ARC12
			in.	mm		in.	mm	in.	mm	in.	mm	in.	mm		
SG-JCFX45-0606	29240-0606	20758293	3/8	9.5	9/16-18	3/4	19	0.43	11.0	1.81	46.0	3.27	83.0	NS	Y
SG-JCFX45-0608	29240-0608	20822038	3/8	9.5	3/4-16	1	25	0.59	15.0	1.85	47.0	3.31	84.0	NS	Y
SG-JCFX45-0808	29240-0808	20758293	1/2	12.7	3/4-16	1	25	0.59	15.0	2.08	52.9	3.62	91.9	NS	Y
SG-JCFX45-0810	29240-0810	20822037	1/2	12.7	7/8-14	1 1/16	27	0.63	16.0	2.01	51.0	3.54	90.0	NS	Y
SG-JCFX45-1010	29240-1010	20822036	5/8	15.9	7/8-14	1 1/16	27	0.63	16.0	1.76	44.8	4.15	105.5	NS	Y
SG-JCFX45-1012 <sup>T</sup>	29240-1012	20822035	5/8	15.9	1 1/16-12	1 1/4	32	0.90	22.9	2.56	65.0	4.15	105.5	NS	Y
SG-JCFX45-1212 <sup>T</sup>	29420-1212	20822034	3/4	19.0	1 1/16-12	1 1/4	32	1.08	27.4	2.79	70.8	4.91	124.8	NS	Y
SG-JCFX45-1216	29420-1216	20822033	3/4	19.0	1 5/16-12	1 1/2	38	1.02	26.0	2.80	71.0	4.67	118.5	NS	Y
SG-JCFX45-1616 <sup>T</sup>	29420-1616	20822032	1	25.4	1 5/16-12	1 1/2	38	1.19	30.1	3.30	83.7	5.58	141.7	NS	Y
SG-JCFX45-1616S <sup>T</sup>	29420-1616S	20822031	1	25.4	1 5/16-12	1 1/2	38	1.19	30.1	3.30	83.7	5.58	141.7	NS	Y
SG-JCFX45-1620 <sup>T</sup>	29420-1620	20822030	1	25.4	1 3/8-12	2	50	1.25	31.8	3.37	85.6	5.65	143.6	NS	Y

T: Thrust-Wire Nut (see "Fitting Identification" in Appendix for details)

S: Stainless Steel

# JIC 37° Flare (SAE J514)

Female | 90° Elbow | Swivel



LT=Long Tube  
ST=Short Tube

S=Skive  
NS=Non-Skive  
DG=Dual-Grip™

Descriptive #	Product #	SAP #	Hose Size ID		Thread Size (A)	Hex-1 Wrench Size		Elbow Type	Drop (D)		Cut-Off (C)		Length (L)		Skive Type	SR12, ARC12
			in.	mm		in.	mm		in.	mm	in.	mm	in.	mm		
S4-JCFX90-0606	28425-0606	20241903	3/8	9.5	9/16-18	3/4	19		1.38	35.0	1.22	31.0	2.28	58.0	NS	Y
S4-JCFX90L-0606	28440-0606	20241975	3/8	9.5	9/16-18	3/4	19	LT	2.13	54.0	1.69	43.0	2.76	70.0	NS	Y
S4-JCFX90-0808	28425-0808	20241910	1/2	12.7	3/4-16	1	25		1.57	40.0	1.46	37.0	2.72	69.0	NS	Y
S4-JCFX90L-0808	28440-0808	20241986	1/2	12.7	3/4-16	1	25	LT	2.52	64.0	1.97	50.0	3.19	81.0	NS	Y
S4-JCFX90-0810	28425-0810	20241912	1/2	12.7	7/8-14	1 1/16	27		1.85	47.0	1.69	43.0	2.95	75.0	NS	Y
S4-JCFX90L-0810	28440-0810	20293261	1/2	12.7	7/8-14	1 1/16	27	LT	2.56	65.0	1.46	37.0	2.72	69.0	NS	Y
S4-JCFX90-1010	28425-1010	20241933	5/8	15.9	7/8-14	1 1/16	27		1.89	48.0	1.93	49.0	3.31	84.0	NS	Y
S4-JCFX90-1012	28425-1012	20241931	5/8	15.9	1 1/16-12	1 1/4	32		2.28	58.0	1.89	48.0	3.23	82.0	NS	Y
S4-JCFX90-1210	28425-1210	20457475	3/4	19.0	7/8-14	1 1/16	27		1.89	48.0	1.97	50.0	3.50	89.0	NS	Y
S4-JCFX90-1212	28425-1212	20241898	3/4	19.0	1 1/16-12	1 1/4	32		2.13	54.0	2.05	52.0	3.62	92.0	NS	Y
S4-JCFX90L-1212	28440-1212	20241972	3/4	19.0	1 1/16-12	1 1/4	32	LT	3.74	95.0	2.13	54.0	3.70	94.0	NS	Y
S4-JCFX90S-1212	28445-1212	20241941	3/4	19.0	1 1/16-12	1 1/4	32	ST	1.81	46.0	2.28	58.0	3.82	97.0	NS	Y
S4-JCFX90-1216	28425-1216	20241901	3/4	19.0	1 5/16-12	1 1/2	38		2.83	72.0	2.09	53.0	3.62	92.0	NS	Y
S4-JCFX90-1616	28425-1616	20241979	1	25.4	1 5/16-12	1 1/2	38		2.81	71.5	2.87	73.0	4.61	117.0	NS	Y
S4-JCFX90L-1616	28440-1616	20241984	1	25.4	1 5/16-12	1 1/2	38	LT	4.49	114.0	3.11	79.0	4.84	123.0	NS	Y
S4-JCFX90S-1616	28445-1616	20241935	1	25.4	1 5/16-12	1 1/2	38	ST	2.20	56.0	2.91	74.0	4.69	119.0	NS	Y
S4-JCFX90-1620	28425-1620	20432491	1	25.4	1 3/8-12	2	50		3.07	78.0	2.87	73.0	4.61	117.0	NS	Y

Continued on next page

# JIC 37° Flare (SAE J514)

## Female | 90° Elbow | Swivel Continued

Descriptive #	Product #	SAP #	Hose Size ID		Thread Size (A)	Hex-1 Wrench Size		Elbow Type	Drop (D)		Cut-Off (C)		Length (L)		Skive Type	SR12, ARC12
			in.	mm		in.	mm		in.	mm	in.	mm	in.	mm		
S4-JCFX90-2020T	28425-2020	20241906	1¼	31.8	1½-12	2	50		3.07	78.0	3.23	82.0	5.28	134.0	NS	Y
S4-JCFX90-2024T	28425-2024	20432492	1¼	31.8	1½-12	2¾/16	55		3.23	82.0	3.43	87.0	5.47	139.0	NS	Y
S4-JCFX90-2424T	28425-2424	20241904	1½	38.1	1¾-12	2¾/16	55		3.62	92.0	3.74	95.0	6.06	154.0	NS	Y
S4-JCFX90-3232T	28425-3232	20657096	2	50.8	2½-12	2¾	70								NS	Y

T: Thrust-Wire Nut (see "Fitting Identification" in Appendix for details)

Descriptive #	Product #	SAP #	Hose Size ID		Thread Size (A)	Hex-1 Wrench Size		Elbow Type	Drop (D)		Cut-Off (C)		Length (L)		Skive Type	SR12, ARC12
			in.	mm		in.	mm		in.	mm	in.	mm	in.	mm		
SG-JCFX90-0606	29425-0606	20758283	3/8	9.5	9/16-18	3/4	19		1.50	38.0	1.22	31.0	2.67	67.7	NS	Y
SG-JCFX90L-0606	29440-0606	20822017	3/8	9.5	9/16-18	3/4	19	LT	2.13	54.0	1.69	43.0	3.15	80.0	NS	Y
SG-JCFX90S-0606	29445-0606	20822008	3/8	9.5	9/16-18	3/4	19	ST	0.91	23.0	1.65	42.0	3.11	79.0	NS	Y
SG-JCFX90-0608	29425-0608	20822028	3/8	9.5	3/4-16	1	25		1.61	41.0	1.54	39.0	2.99	76.0	NS	Y
SG-JCFX90L-0608	29440-0608	20822016	3/8	9.5	3/4-16	1	25	LT	2.52	64.0	1.85	47.0	3.31	84.0	NS	Y
SG-JCFX90S-0608	29445-0608	20822007	3/8	9.5	3/4-16	1	25	ST	1.85	47.0	1.93	49.0	3.39	86.0	NS	Y
SG-JCFX90-0808	29425-0808	20758292	1/2	12.7	3/4-16	1	25		1.58	40.0	1.49	37.9	3.03	76.9	NS	Y
SG-JCFX90L-0808	29440-0808	20822015	1/2	12.7	3/4-16	1	25	LT	2.52	64.0	2.01	50.9	3.54	89.9	NS	Y
SG-JCFX90S-0808	29445-0808	20822006	1/2	12.7	3/4-16	1	25	ST	1.14	29.0	1.81	46.0	3.38	85.9	NS	Y
SG-JCFX90-0810	29425-0810	20822027	1/2	12.7	7/8-14	1½/16	27		1.85	47.0	1.69	43.0	3.23	82.0	NS	Y
SG-JCFX90L-0810	29440-0810	20822014	1/2	12.7	7/8-14	1½/16	27	LT	2.76	70.0	1.46	37.0	2.99	76.0	NS	Y
SG-JCFX90S-0810	29445-0810	20822005	1/2	12.7	7/8-14	1½/16	27	ST	1.26	32.0	1.81	46.0	3.38	85.9	NS	Y
SG-JCFX90-0812	29445-0812	20822026	1/2	12.7	1½-12	1¼	32		1.81	46.0	1.49	37.9	3.03	76.9	NS	Y
SG-JCFX90-1010	29425-1010	20822025	5/8	15.9	7/8-14	1½/16	27		1.85	47.0	1.76	44.8	3.52	89.5	NS	Y
SG-JCFX90L-1010	29440-1010	20822013	5/8	15.9	7/8-14	1½/16	27	LT	2.76	70.0	1.76	44.8	3.56	90.5	NS	Y
SG-JCFX90S-1010	29445-1010	20822004	5/8	15.9	7/8-14	1½/16	27	ST	1.26	32.0	1.76	44.8	3.52	89.5	NS	Y
SG-JCFX90-1012T	29425-1012	20822024	5/8	15.9	1½-12	1¼	32		2.28	58.0	2.35	59.7	3.94	100.2	NS	Y
SG-JCFX90L-1012T	29440-1012	20822012	5/8	15.9	1½-12	1¼	32	LT	3.78	96.0	2.35	59.7	3.94	100.2	NS	Y
SG-JCFX90-1210	29425-1210	20822023	3/4	19.0	7/8-14	1½/16	27		1.85	47.0	1.97	50.0	3.84	97.5	NS	Y
SG-JCFX90L-1210	29440-1210	20822011	3/4	19.0	7/8-14	1½/16	27	LT	2.76	70.0	1.97	50.0	3.84	97.5	NS	Y
SG-JCFX90S-1210	29445-1210	20822003	3/4	19.0	7/8-14	1½/16	27	ST	1.26	32.0	1.97	50.0	3.84	97.5	NS	Y
SG-JCFX90-1212T	29425-1212	20822022	3/4	19.0	1½-12	1¼	32		2.24	56.9	2.35	59.7	4.22	107.2	NS	Y
SG-JCFX90L-1212T	29440-1212	20822010	3/4	19.0	1½-12	1¼	32	LT	3.78	96.0	2.35	59.7	4.22	107.2	NS	Y
SG-JCFX90S-1212T	29445-1212	20822002	3/4	19.0	1½-12	1¼	32	ST	1.89	48.0	2.35	59.7	4.22	107.2	NS	Y
SG-JCFX90-1216T	29425-1216	20822021	3/4	19.0	1½-12	1½	38		2.80	71.0	2.35	59.7	4.22	107.2	NS	Y
SG-JCFX90-1616T	29425-1616	20822020	1	25.4	1½-12	1½	38		2.80	71.0	2.97	75.5	5.25	133.5	NS	Y
SG-JCFX90L-1616T	29440-1616	20822009	1	25.4	1½-12	1½	38	LT	4.49	114.0	3.10	78.7	5.38	136.7	NS	Y
SG-JCFX90S-1616T	29445-1616	20822001	1	25.4	1½-12	1½	38	ST	2.44	61.9	2.55	64.8	4.83	122.8	NS	Y
SG-JCFX90-1620T	29425-1620	20822019	1	25.4	1¾-12	2	50		3.07	78.0	2.87	72.9	5.15	130.9	NS	Y

T: Thrust-Wire Nut (see "Fitting Identification" in Appendix for details)

# JIC 37° Flare (SAE J514)

Male

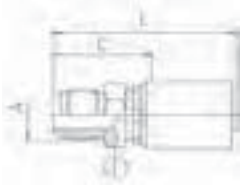

S=Skive  
NS=Non-Skive  
DG=Dual-Grip™

Descriptive #	Product #	SAP #	Hose Size ID		Thread Size (A)	Hex-1 Wrench Size		Cut-Off (C)		Length (L)		Skive Type	SR12, ARC12
			in.	mm		in.	mm	in.	mm	in.	mm		
S4-JCM-0606	28450-0606	20242013	3/8	9.5	9/16-18	11/16	17	1.04	26.3	2.09	53.0	NS	Y
S4-JCM-0608	28450-0608	20242015	3/8	9.5	3/4-16	3/4	19	1.17	29.8	2.22	56.5	NS	Y
S4-JCM-0808	28450-0808	20242006	1/2	12.7	3/4-16	3/4	19	1.20	30.6	2.44	62.1	NS	Y
S4-JCM-0810	28450-0810	20241992	1/2	12.7	7/8-14	15/16	24	1.36	34.6	2.60	66.1	NS	Y
S4-JCM-0812	28450-0812	20241996	1/2	12.7	1 1/8-12	1 1/16	27	1.46	37.1	2.70	68.6	NS	Y
S4-JCM-1010	28450-1010	20242009	5/8	15.9	7/8-14	15/16	24	1.36	34.6	2.71	68.9	NS	Y
S4-JCM-1212	28450-1212	20242021	3/4	19.0	1 1/8-12	1 1/16	27	1.48	37.6	3.04	77.1	NS	Y
S4-JCM-1214	28450-1214	20242019	3/4	19.0	1 3/8-12	1 1/4	32	1.58	40.1	3.13	79.6	NS	Y
S4-JCM-1216	28450-1216	20242017	3/4	19.0	1 5/8-12	1 7/16	36	1.68	42.6	3.23	82.1	NS	Y
S4-JCM-1616	28450-1616	20242001	1	25.4	1 5/8-12	1 7/16	36	1.71	43.4	3.46	88.0	NS	Y
S4-JCM-1620	28450-1620	20242000	1	25.4	1 3/8-12	1 13/16	46	1.85	46.9	3.60	91.5	NS	Y
S4-JCM-2020	28450-2020	20241999	1 1/4	31.8	1 3/8-12	1 13/16	46	1.91	48.5	3.96	100.5	NS	Y
S4-JCM-2024	28450-2024	20241998	1 1/4	31.8	1 7/8-12	2	50	2.07	52.5	4.11	104.5	NS	Y
S4-JCM-2424	28450-2424	20242027	1 1/2	38.1	1 7/8-12	2	50	2.07	52.5	4.39	111.5	NS	Y
S4-JCM-3232	28450-3232	20242023	2	50.8	2 1/2-12	2 9/16	65	2.44	62.0	5.28	134.0	NS	Y

Descriptive #	Product #	SAP #	Hose Size ID		Thread Size (A)	Hex-1 Wrench Size		Cut-Off (C)		Length (L)		Skive Type	SR12, ARC12
			in.	mm		in.	mm	in.	mm	in.	mm		
SG-JCM-0606	29450-0606	20758249	3/8	9.5	9/16-18	11/16	17	1.15	29.1	2.60	66.1	NS	Y
SG-JCM-0608	29450-0608	20758285	3/8	9.5	3/4-16	3/4	19	1.29	32.8	2.75	69.9	NS	Y
SG-JCM-0610	29450-0610	20822000	3/8	9.5	7/8-14	15/16	24	1.45	36.8	2.91	73.8	NS	Y
SG-JCM-0808	29450-0808	20758291	1/2	12.7	3/4-16	3/4	19	1.29	32.8	2.83	71.9	NS	Y
SG-JCM-0810	29450-0810	20758296	1/2	12.7	7/8-14	15/16	24	1.45	36.8	2.99	75.8	NS	Y
SG-JCM-0812	29450-0812	20758295	1/2	12.7	1 1/8-12	1 1/16	27	1.54	39.1	3.07	78.1	NS	Y
SG-JCM-1010	29450-1010	20821999	5/8	15.9	7/8-14	15/16	24	1.47	37.3	3.06	77.8	NS	Y
SG-JCM-1012	29450-1012	20821998	5/8	15.9	1 1/8-12	1 1/16	27	1.56	39.6	3.15	80.1	NS	Y
SG-JCM-1212	29450-1212	20821997	3/4	19.0	1 1/8-12	1 1/16	27	1.60	40.6	3.47	88.1	NS	Y
SG-JCM-1214	29450-1229	20821996	3/4	19.0	1 3/8-12	1 1/4	32	1.73	43.9	3.60	91.4	NS	Y
SG-JCM-1216	29450-1216	20821995	3/4	19.0	1 5/8-12	1 7/16	36	1.77	45.1	3.66	93.1	NS	Y
SG-JCM-1616	29450-1616	20821994	1	25.4	1 5/8-12	1 7/16	36	1.83	46.6	4.12	104.6	NS	Y
SG-JCM-1620	29450-1620	20821993	1	25.4	1 3/8-12	1 13/16	46	1.99	50.5	4.27	108.6	NS	Y

# NPTF

Female

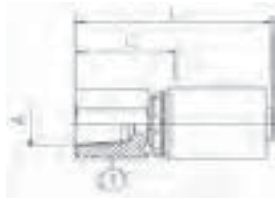

S=Skive  
NS=Non-Skive  
DG=Dual-Grip™

Descriptive #	Product #	SAP #	Hose Size ID		Thread Size (A)	Hex-1 Wrench Size		Cut-Off (C)		Length (L)		Skive Type	SR12, ARC12
			in.	mm		in.	mm	in.	mm	in.	mm		
SG-NPF-0808	29600-0808	20821973	1/2	12.7	1/2-14	1	25	1.48	37.6	3.02	76.6	NS	Y

# NPTF

Male

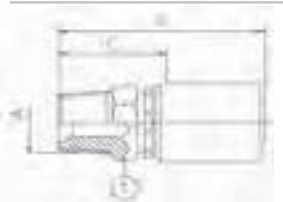

S=Skive  
NS=Non-Skive  
DG=Dual-Grip™

Descriptive #	Product #	SAP #	Hose Size ID		Thread Size (A)	Hex-1 Wrench Size		Cut-Off (C)		Length (L)		Skive Type	SR12, ARC12
			in.	mm		in.	mm	in.	mm	in.	mm		
S4-NPM-0604	28615-0604	20242068	3/8	9.5	1/4-18	11/16	17	1.06	26.8	2.11	53.5	NS	Y
S4-NPM-0606	28615-0606	20242070	3/8	9.5	3/8-18	3/4	19	1.09	27.8	2.15	54.5	NS	Y
S4-NPM-0608	28615-0608	20242073	3/8	9.5	1/2-14	7/8	22	1.23	31.3	2.28	58.0	NS	Y
S4-NPM-0806	28615-0806	20242114	1/2	12.7	3/8-18	3/4	19	1.13	28.6	2.37	60.1	NS	Y
S4-NPM-0808	28615-0808	20242100	1/2	12.7	1/2-14	7/8	22	1.26	32.1	2.50	63.6	NS	Y
S4-NPM-0812	28615-0812	20242112	1/2	12.7	3/4-14	1 1/16	27	1.34	34.1	2.58	65.6	NS	Y
S4-NPM-1012	28615-1012	20242072	5/8	15.9	3/4-14	1 1/16	27	1.34	34.1	2.69	68.4	NS	Y
S4-NPM-1208	28615-1208	20242090	3/4	19.0	1/2-14	1 1/16	27	1.32	33.6	2.88	73.1	NS	Y
S4-NPM-1212	28615-1212	20242075	3/4	19.0	3/4-14	1 1/16	27	1.36	34.6	2.92	74.1	NS	Y
S4-NPM-1212S	28615-1212S	20424928	3/4	19.0	3/4-14	1 1/16	27	1.36	34.6	2.92	74.1	NS	Y
S4-NPM-1216	28615-1216	20242097	3/4	19.0	1-11 1/2	1 7/16	36	1.72	43.6	3.27	83.1	NS	Y
S4-NPM-1612	28615-1612	20242096	1	25.4	3/4-14	1 7/16	36	1.55	39.4	3.31	84.0	NS	Y
S4-NPM-1616	28615-1616	20242098	1	25.4	1-11 1/2	1 7/16	36	1.75	44.4	3.50	89.0	NS	Y
S4-NPM-1616S	28615-1616S	20424929	1	25.4	1-11 1/2	1 7/16	36	1.75	44.4	3.50	89.0	NS	Y
S4-NPM-1620	28615-1620	20242101	1	25.4	1 1/4-11 1/2	1 3/16	46	1.87	47.4	3.62	92.0	NS	Y
S4-NPM-2020	28615-2020	20242094	1 1/4	31.8	1 1/4-11 1/2	1 3/16	46	1.93	49.0	3.98	101.0	NS	Y
S4-NPM-2020S	28615-2020S	20424930	1 1/4	31.8	1 1/4-11 1/2	1 3/16	46	1.93	49.0	3.98	101.0	NS	Y
S4-NPM-2024	28615-2024	20242095	1 1/4	31.8	1 1/2-11 1/2	2	50	1.99	50.5	4.04	102.5	NS	Y
S4-NPM-2424	28615-2424	20242102	1 1/2	38.1	1 1/2-11 1/2	2	50	1.99	50.5	4.31	109.5	NS	Y
S4-NPM-2424S	28615-2424S	20424931	1 1/2	38.1	1 1/2-11 1/2	2	50	1.99	50.5	4.31	109.5	NS	Y
S4-NPM-3232	28615-3232	20242108	2	50.8	2-11 1/2	2 9/16	65	2.13	54.2	4.97	126.2	NS	Y

Continued on next page

# NPTF

## Male Continued

Descriptive #	Product #	SAP #	Hose Size ID		Thread Size (A)	Hex-1 Wrench Size		Cut-Off (C)		Length (L)		Skive Type	SR12, ARC12
			in.	mm		in.	mm	in.	mm	in.	mm		
SG-NPM-0604	29615-0604	20731608	3/8	9.5	1/4-18	11/16	17	1.17	29.7	2.63	66.8	NS	Y
SG-NPM-0606	29615-0606	20731748	3/8	9.5	3/8-18	3/4	19	1.20	30.5	2.66	67.5	NS	Y
SG-NPM-0606S	29615-0606S	20821971	3/8	9.5	3/8-18	3/4	19	1.20	30.5	2.66	67.5	NS	Y
SG-NPM-0608	29615-0608	20758280	3/8	9.5	1/2-14	7/8	22	1.37	34.9	2.83	71.9	NS	Y
SG-NPM-0806	29615-0806	20731755	1/2	12.7	3/8-18	3/4	19	1.20	30.5	2.73	69.4	NS	Y
SG-NPM-0808	29615-0808	20753007	1/2	12.7	1/2-14	7/8	22	1.37	34.9	2.91	73.9	NS	Y
SG-NPM-0808S	29615-0808S	20821970	1/2	12.7	1/2-14	7/8	22	1.37	34.9	2.91	73.9	NS	Y
SG-NPM-0812	29615-0812	20758303	1/2	12.7	3/4-14	1 1/16	27	1.42	36.0	2.95	75.0	NS	Y
SG-NPM-1012	29615-1012	20821969	5/8	15.9	3/4-14	1 1/16	27	1.44	36.5	3.03	77.0	NS	Y
SG-NPM-1208	29615-1208	20821968	3/4	19.0	1/2-14	1 1/16	27	1.43	36.4	3.30	83.9	NS	Y
SG-NPM-1212	29615-1212	20821967	3/4	19.0	3/4-14	1 1/16	27	1.48	37.5	3.35	85.0	NS	Y
SG-NPM-1212S	29615-1212S	20821966	3/4	19.0	3/4-14	1 1/16	27	1.48	37.5	3.35	85.0	NS	Y
SG-NPM-1216	29615-1216	20821965	3/4	19.0	1-11 1/2	1 7/16	36	1.83	46.6	3.70	94.1	NS	Y
SG-NPM-1612	29615-1612	20821964	1	25.4	3/4-14	1 7/16	36	1.70	43.2	3.99	101.2	NS	Y
SG-NPM-1616	29615-1616	20821963	1	25.4	1-11 1/2	1 7/16	36	1.89	48.1	4.18	106.1	NS	Y
SG-NPM-1616S	29615-1616S	20821962	1	25.4	1-11 1/2	1 7/16	36	1.89	48.1	4.18	106.1	NS	Y
SG-NPM-1620	29615-1620	20821961	1	25.4	1 1/4-11 1/2	1 13/16	46	2.03	51.5	4.31	109.5	NS	Y

S: Stainless Steel

# NPTF

## Male | Swivel

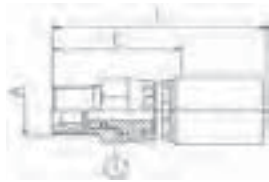

S=Skive  
NS=Non-Skive  
DG=Dual-Grip™

Descriptive #	Product #	SAP #	Hose Size ID		Thread Size (A)	Hex-1 Wrench Size		Cut-Off (C)		Length (L)		Skive Type	SR12, ARC12
			in.	mm		in.	mm	in.	mm	in.	mm		
S4-NPMX-0606	28645-0606	20242080	3/8	9.5	3/8-18	7/8	22	1.48	37.5	2.53	64.2	NS	Y
S4-NPMX-0808	28645-0808	20242089	1/2	12.7	1/2-14	1	25	1.67	42.3	2.91	73.8	NS	Y
S4-NPMX-1212	28645-1212	20242084	3/4	19.0	3/4-14	1 1/4	32	1.97	50.1	3.53	89.6	NS	Y

Descriptive #	Product #	SAP #	Hose Size ID		Thread Size (A)	Hex-1 Wrench Size		Cut-Off (C)		Length (L)		Skive Type	SR12, ARC12
			in.	mm		in.	mm	in.	mm	in.	mm		
SG-NPMX-0604	29645-0604	20821959	3/8	9.5	1/4-18	11/16	17	1.67	42.3	3.12	79.3	NS	Y
SG-NPMX-0606	29645-0606	20821958	3/8	9.5	3/8-18	7/8	22	1.58	40.1	3.04	77.1	NS	Y
SG-NPMX-0608	29645-0608	20821957	3/8	9.5	1/2-14	1	25	1.73	44.0	3.19	81.0	NS	Y
SG-NPMX-0806	29645-0806	20821956	1/2	12.7	3/8-18	7/8	22	1.58	40.1	3.12	79.1	NS	Y
SG-NPMX-0808	29645-0808	20821955	1/2	12.7	1/2-14	1	25	1.73	44.0	3.27	83.0	NS	Y
SG-NPMX-1212	29645-1212	20821954	3/4	19.0	3/4-14	1 1/4	32	2.08	52.8	3.95	100.3	NS	Y
SG-NPMX-1616	29645-1616	20821953	1	25.4	1-11 1/2	1 3/8	41	2.40	60.9	4.68	118.9	NS	Y

# NPT

Male API



S=Skive  
NS=Non-Skive  
DG=Dual-Grip™

Descriptive #	Product #	SAP #	Hose Size ID		Thread Size (A)	Hex-1 Wrench Size		Cut-Off (C)		Length (L)		Skive Type	SR12, ARC12
			in.	mm		in.	mm	in.	mm	in.	mm		
SG-NPMAPI-1616	29617-1616	20821960	1	25.4	1-11½	1¼	36	2.72	69.0	5.00	127.0	NS	Y

# NPSM

Female | Swivel

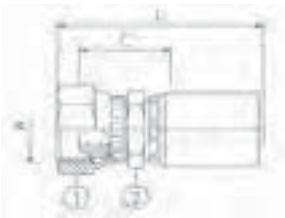

S=Skive  
NS=Non-Skive  
DG=Dual-Grip™

Descriptive #	Product #	SAP #	Hose Size ID		Thread Size (A)	Hex-1 Wrench Size		Hex-2 Wrench Size		Cut-Off (C)		Length (L)		Skive Type	SR12, ARC12
			in.	mm		in.	mm	in.	mm	in.	mm	in.	mm		
S4-NSFX-2020	28655-2020	20293263	¼	31.8	1¼-11½	2	50	1½	41	1.73	52.0	3.78	104.0	NS	Y

Descriptive #	Product #	SAP #	Hose Size ID		Thread Size (A)	Hex-1 Wrench Size		Hex-2 Wrench Size		Cut-Off (C)		Length (L)		Skive Type	SR12, ARC12
			in.	mm		in.	mm	in.	mm	in.	mm	in.	mm		
SG-NSFX-0606	29655-0606	20821948	3/8	9.5	3/8-18	7/8	22	17	11/16	1.29	32.8	2.75	69.8	NS	Y
SG-NSFX-0808	29655-0808	20821947	1/2	12.7	1/2-14	11/16	27	7/8	22	1.41	35.8	2.95	74.8	NS	Y

# Standpipe

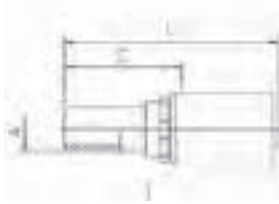

S=Skive  
NS=Non-Skive  
DG=Dual-Grip™

Descriptive #	Product #	SAP #	Hose Size ID		Tube O.D.	Cut-Off (C)		Length (L)		Skive Type	SR12, ARC12
			in.	mm	(A) mm	in.	mm	in.	mm		
SG-SP-1628	29825-1628	20821784	1	25.4	28	1.73	43.9	4.01	101.9	NS	Y

# O-Ring Face Seal (SAE J1453 ORS/ORFS)

Female | Swivel

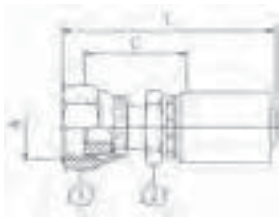

S=Skive  
NS=Non-Skive  
DG=Dual-Grip™

Descriptive #	Product #	SAP #	Hose Size ID		Thread Size (A)	Hex-1 Wrench Size		Hex-2 Wrench Size		Cut-Off (C)		Length (L)		Skive Type	SR12, ARC12
			in.	mm	in.	mm	in.	mm	in.	mm	in.	mm	in.		
S4-OFFX-0606	28700-0606	20242197	3/8	9.5	11/16-16	7/8	22	11/16	17	1.19	30.3	2.62	66.5	NS	Y
S4-OFFX-0608	28700-0608	20581892	3/8	9.5	13/16-16	15/16	24	7/8	22	1.40	35.6	2.45	62.2	NS	Y
S4-OFFX-0808	28700-0808	20242147	1/2	12.7	13/16-16	15/16	24	7/8	22	1.42	36.1	3.09	78.6	NS	Y
S4-OFFX-0810	28700-0810	20242145	1/2	12.7	1-14	1 3/16	30	15/16	24	1.56	39.6	3.31	84.1	NS	Y
S4-OFFX-0812	28700-0812	20242135	1/2	12.7	1 3/16-12	1 7/16	36	1 3/16	30	1.66	42.1	3.47	88.1	NS	Y
S4-OFFX-1010	28700-1010	20242176	5/8	15.9	1-14	1 3/16	30	15/16	24	1.56	39.6	3.39	86.1	NS	Y
S4-OFFX-1012	28700-1012	20242200	5/8	15.9	1 3/16-12	1 7/16	36	1 3/16	30	1.66	42.1	3.58	90.9	NS	Y
S4-OFFX-1210	28700-1210	20242195	3/4	19.0	1-14	1 3/16	30	1 1/16	27	1.58	40.1	3.65	92.6	NS	Y
S4-OFFX-1212	28700-1212	20242190	3/4	19.0	1 3/16-12	1 7/16	36	1 3/16	30	1.68	42.6	3.80	96.6	NS	Y
S4-OFFX-1216	28700-1216	20242193	3/4	19.0	1 7/16-12	1 5/8	41	1 7/16	36	1.91	48.6	4.05	102.9	NS	Y
S4-OFFX-1612	28700-1612	20242146	1	25.4	1 3/16-12	1 7/16	36	1 1/4	32	1.79	45.4	4.11	104.5	NS	Y
S4-OFFX-1616	28700-1616	20242140	1	25.4	1 7/16-12	1 5/8	41	1 7/16	36	1.94	49.4	4.28	108.8	NS	Y
S4-OFFX-1620	28700-1620	20242165	1	25.4	1 11/16-12	2	50	1 5/8	41	1.98	50.4	4.32	109.8	NS	Y
S4-OFFX-2020	28700-2020	20242137	1 1/4	31.8	1 11/16-12	2	50	1 5/8	41	2.05	52.0	4.68	118.8	NS	Y
S4-OFFX-2424	28700-2424	20242138	1 1/2	38.1	2-12	2 3/8	60	2	50	2.22	56.5	5.18	131.5	NS	Y

Descriptive #	Product #	SAP #	Hose Size ID		Thread Size (A)	Hex-1 Wrench Size		Hex-2 Wrench Size		Cut-Off (C)		Length (L)		Skive Type	SR12, ARC12
			in.	mm	in.	mm	in.	mm	in.	mm	in.	mm			
SG-OFFX-0604	29700-0604	20821928	3/8	9.5	9/16-18	7/8	17	11/16	17	1.29	32.8	2.75	69.9	NS	Y
SG-OFFX-0606	29700-0606	20758282	3/8	9.5	11/16-16	7/8	22	11/16	18	1.29	32.8	2.75	69.9	NS	Y
SG-OFFX-0608	29700-0608	20731751	3/8	9.5	13/16-16	15/16	24	7/8	22	1.50	38.1	2.96	75.1	NS	Y

Continued on next page

## O-Ring Face Seal (SAE J1453 ORS/ORFS)

Female | Swivel Continued

Descriptive #	Product #	SAP #	Hose Size ID		Thread Size (A)	Hex-1 Wrench Size		Hex-2 Wrench Size		Cut-Off (C)		Length (L)		Skive Type	SR12, ARC12
			in.	mm		in.	mm	in.	mm	in.	mm	in.	mm		
SG-OFFX-0806	29700-0806	20821927	1/2	12.7	11/16-16	7/8	22	3/4	19	1.34	34.0	2.87	73.0	NS	Y
SG-OFFX-0808	29700-0808	20731750	1/2	12.7	13/16-16	15/16	24	7/8	22	1.50	38.1	3.04	77.1	NS	Y
SG-OFFX-0810	29700-0810	20731764	1/2	12.7	1-14	1 3/16	30	15/16	24	1.63	41.5	3.17	80.5	NS	Y
SG-OFFX-0812	29700-0812	20731759	1/2	12.7	1 3/16-12	1 7/16	36	1 3/16	30	1.74	44.1	3.27	83.1	NS	Y
SG-OFFX-1010	29700-1010	20821925	5/8	15.9	1-14	1 3/16	30	15/16	24	1.65	42.0	3.25	82.5	NS	Y
SG-OFFX-1012	29700-1012	20821924	5/8	15.9	1 3/16-12	1 7/16	36	1 3/16	30	1.75	44.5	3.35	85.0	NS	Y
SG-OFFX-1210	29700-1210	20821923	3/4	19.0	1-14	1 3/16	30	1 1/16	27	1.69	43.0	3.56	90.4	NS	Y
SG-OFFX-1212	29700-1212	20821922	3/4	19.0	1 3/16-12	1 7/16	36	1 3/16	30	1.78	45.2	3.65	92.7	NS	Y
SG-OFFX-1216	29700-1216	20821921	3/4	19.0	1 7/16-12	1 5/8	41	1 7/16	36	2.03	51.5	3.90	99.0	NS	Y
SG-OFFX-1612	29700-1612	20821920	1	25.4	1 3/16-12	1 7/16	36	1 1/4	32	1.95	49.4	4.23	107.4	NS	Y
SG-OFFX-1616	29700-1616	20821919	1	25.4	1 7/16-12	1 5/8	41	1 7/16	36	2.10	53.4	4.39	111.4	NS	Y
SG-OFFX-1620	29700-1620	20821918	1	25.4	1 11/16-12	2	50	1 5/8	41	1.99	50.5	4.27	108.5	NS	Y

## O-Ring Face Seal (SAE J1453 ORS/ORFS)

Female | 45° Elbow | Swivel

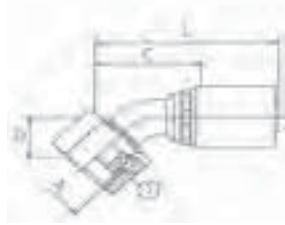

S=Skive  
NS=Non-Skive  
DG=Dual-Grip™

Descriptive #	Product #	SAP #	Hose Size ID		Thread Size (A)	Hex-1 Wrench Size		Drop (D)		Cut-Off (C)		Length (L)		Skive Type	SR12, ARC12
			in.	mm		in.	mm	in.	mm	in.	mm	in.	mm		
S4-OFFX45-0606	28710-0606	20242205	3/8	9.5	11/16-16	7/8	22	0.47	12.0	1.85	47.0	2.91	74.0	NS	Y
S4-OFFX45-0808 <sup>C</sup>	28710-0808	20242229	1/2	12.7	13/16-16	15/16	24	0.63	16.0	1.85	47.0	3.11	79.0	NS	Y
S4-OFFX45-0810	28710-0810	20242234	1/2	12.7	1-14	1 3/16	30	0.65	16.5	1.97	50.0	3.23	82.0	NS	Y
S4-OFFX45-1010	28710-1010	20242209	5/8	15.9	1-14	1 3/16	30	0.67	17.0	2.28	58.0	3.62	92.0	NS	Y
S4-OFFX45-1212	28710-1212	20242233	3/4	19.0	1 3/16-12	1 7/16	36	0.83	21.0	2.48	63.0	4.06	103.0	NS	Y
S4-OFFX45-1616	28710-1616	20242220	1	25.4	1 7/16-12	1 5/8	41	1.02	26.0	3.23	82.0	5.00	127.0	NS	Y
S4-OFFX45-1620	28710-1620	20242218	1	25.4	1 11/16-12	2	50	1.02	26.0	3.35	85.0	5.41	137.5	NS	Y
S4-OFFX45-2020	28710-2020	20242223	1 1/4	31.8	1 11/16-12	2	50	1.02	26.0	3.82	97.0	6.16	156.5	NS	Y
S4-OFFX45-2024	28710-2024	20242224	1 1/4	31.8	2-12	2 3/8	60	1.10	28.0	3.98	101.0	6.34	161.0	NS	Y
S4-OFFX45-2424	28710-2424	20242222	1 1/2	38.1	2-12	2 3/8	60	1.10	28.0	4.13	105.0	6.77	172.0	NS	Y

Descriptive #	Product #	SAP #	Hose Size ID		Thread Size (A)	Hex-1 Wrench Size		Drop (D)		Cut-Off (C)		Length (L)		Skive Type	SR12, ARC12
			in.	mm		in.	mm	in.	mm	in.	mm	in.	mm		
SG-OFFX45-0606	29710-0606	20758286	3/8	9.5	11/16-16	7/8	22	0.43	11.0	1.85	47.0	3.31	84.0	NS	Y
SG-OFFX45-0608	29710-0608	20821917	3/8	9.5	13/16-16	15/16	24	0.59	15.0	2.01	51.1	3.47	88.1	NS	
SG-OFFX45-0808	29710-0808	20731758	1/2	12.7	13/16-16	15/16	24	0.63	16.0	1.85	47.0	3.42	86.9	NS	Y
SG-OFFX45-0810	29710-0810	20758300	1/2	12.7	1-14	1 3/16	30	0.63	16.0	1.97	50.0	3.51	89.0	NS	Y

Continued on next page



## O-Ring Face Seal (SAE J1453 ORS/ORFS)

Female | 45° Elbow | Swivel Continued

Descriptive #	Product #	SAP #	Hose Size ID		Thread Size (A)	Hex-1 Wrench Size		Drop (D)		Cut-Off (C)		Length (L)		Skive Type	SR12, ARC12
			in.	mm		in.	mm	in.	mm	in.	mm	in.	mm		
SG-OFFX45-1010	29710-1010	20821916	5/8	15.9	1-14	1 3/16	30	0.63	16.0	1.65	42.0	3.86	98.0	NS	Y
SG-OFFX45-1212	29710-1212	20821915	3/4	19.0	1 3/16-12	1 7/16	36	0.83	21.0	2.56	64.9	4.43	112.4	NS	Y
SG-OFFX45-1216	29710-1216	20821914	3/4	19.0	1 3/16-12	1 5/8	41	0.95	24.0	2.80	71.1	4.67	118.6	NS	Y
SG-OFFX45-1616	29710-1616	20821913	1	25.4	1 7/16-12	1 5/8	41	1.02	26.0	3.15	80.0	5.43	137.9	NS	Y
SG-OFFX45-1620	29710-1620	20758286	1	25.4	1 11/16-12	2	50	1.26	32.0	3.35	85.1	5.63	143.1	NS	Y

C: Crimp Nut (see "Fitting Identification" in Appendix for details)

## O-Ring Face Seal (SAE J1453 ORS/ORFS)

Female | 90° Elbow | Swivel

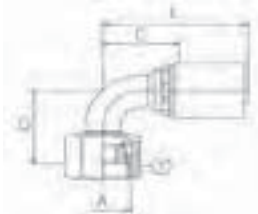

LT=Long Tube  
ST=Short Tube

S=Skive  
NS=Non-Skive  
DG=Dual-Grip™

Descriptive #	Product #	SAP #	Hose Size ID		Thread Size (A)	Hex-1 Wrench Size		Elbow Type	Drop (D)		Cut-Off (C)		Length (L)		Skive Type	SR12, ARC12
			in.	mm		in.	mm		in.	mm	in.	mm	in.	mm		
S4-OFFX90-0606	28715-0606	20242240	3/8	9.5	11/16-16	7/8	22		1.50	38.0	1.65	42.0	2.72	69.0	NS	Y
S4-OFFX90L-0606	28720-0606	20241695	3/8	9.5	11/16-16	7/8	22	LT	2.13	54.0	1.65	42.0	2.72	69.0	NS	Y
S4-OFFX90S-0606	28725-0606	20242210	3/8	9.5	11/16-16	7/8	22	ST	0.98	25.0	1.65	42.0	2.72	69.0	NS	Y
S4-OFFX90-0808 <sup>C</sup>	28715-0808	20241697	1/2	12.7	13/16-16	15/16	24		1.65	42.0	1.38	35.0	2.60	66.0	NS	Y
S4-OFFX90L-0808 <sup>C</sup>	28720-0808	20242203	1/2	12.7	13/16-16	15/16	24	LT	2.52	64.0	1.50	38.0	2.76	70.0	NS	Y
S4-OFFX90S-0808 <sup>C</sup>	28725-0808	20242192	1/2	12.7	13/16-16	15/16	24	ST	1.14	29.0	1.57	40.0	2.80	71.0	NS	Y
S4-OFFX90L-0810	28720-0810	20242215	1/2	12.7	1-14	1 3/16	30	LT	2.76	70.0	1.81	46.0	3.07	78.0	NS	Y
S4-OFFX90S-0810	28725-0810	20242241	1/2	12.7	1-14	1 3/16	30	ST	1.28	32.5	1.81	46.0	3.07	78.0	NS	Y
S4-OFFX90S-1010	28725-1010	20242163	5/8	15.9	1-14	1 3/16	30	ST	1.73	44.0	2.17	55.0	3.54	90.0	NS	Y
S4-OFFX90S-1210 <sup>C</sup>	28725-1210	20241723	3/4	19.0	1-14	1 3/16	30	ST	1.26	32.0	1.75	44.5	3.31	84.0	NS	Y
S4-OFFX90L-1212	28720-1212	20241693	3/4	19.0	1 3/16-12	1 7/16	36	LT	3.78	96.0	2.44	62.0	3.98	101.0	NS	Y
S4-OFFX90S-1212	28725-1212	20242154	3/4	19.0	1 3/16-12	1 7/16	36	ST	2.01	51.0	2.40	61.0	3.94	100.0	NS	Y
S4-OFFX90S-1216	28725-1216	20242156	3/4	19.0	1 7/16-12	1 5/8	41	ST	2.80	71.0	2.60	66.0	4.13	105.0	NS	Y
S4-OFFX90-1616	28715-1616	20241699	1	25.4	1 7/16-12	1 5/8	41		2.60	66.0	3.27	83.0	5.00	127.0	NS	Y
S4-OFFX90L-1616	28720-1616	20242211	1	25.4	1 7/16-12	1 5/8	41	LT	4.49	114.0	3.27	83.0	5.00	127.0	NS	Y
S4-OFFX90S-1616	28725-1616	20242245	1	25.4	1 7/16-12	1 5/8	41	ST	2.28	58.0	3.27	83.0	5.00	127.0	NS	Y
S4-OFFX90-2020	28715-2020	20241702	1 1/4	31.8	1 11/16-12	2	50		3.07	78.0	3.82	97.0	5.87	149.0	NS	Y
S4-OFFX90L-2020	28720-2020	20242212	1 1/4	31.8	1 11/16-12	2	50	LT	5.08	129.0	3.82	97.0	5.87	149.0	NS	Y
S4-OFFX90S-2020	28725-2020	20242247	1 1/4	31.8	1 11/16-12	2	50	ST	2.68	68.0	3.74	95.0	5.79	147.0	NS	Y
S4-OFFX90L-2024	28720-2024	20242213	1 1/4	31.8	2-12	2 5/8	60	LT	5.55	141.0	4.02	102.0	6.06	154.0	NS	Y
S4-OFFX90S-2024	28725-2024	20242248	1 1/4	31.8	2-12	2 5/8	60	ST	2.72	69.0	4.02	102.0	6.06	154.0	NS	Y
S4-OFFX90-2424	28715-2424	20241701	1 1/2	38.1	2-12	2 5/8	60		3.43	87.0	4.25	108.0	6.57	167.0	NS	Y
S4-OFFX90L-2424	28720-2424	20441321	1 1/2	38.1	2-12	2 5/8	60	LT	5.55	141.0	4.37	111.0	6.69	170.0	NS	Y
S4-OFFX90S-2424	28725-2424	20242246	1 1/2	38.1	2-12	2 5/8	60	ST	3.07	78.0	4.02	102.0	6.34	161.0	NS	Y

C: Crimp Nut (see "Fitting Identification" in Appendix for details)

Continued on next page

# O-Ring Face Seal (SAE J1453 ORS/ORFS)

Female | 90° Elbow | Swivel Continued

Descriptive #	Product #	SAP #	Hose Size ID		Thread Size (A)		Hex-1 Wrench Size		Elbow Type	Drop (D)		Cut-Off (C)		Length (L)		Skive Type	SR12, ARC12
			in.	mm	in.	mm	in.	mm		in.	mm	in.	mm	in.	mm		
SG-OFFX90-0606	29715-0606	20731757	3/8	9.5	11/16-16	7/8	22			1.50	38.0	1.65	42.0	3.11	79.0	NS	Y
SG-OFFX90L-0606	29720-0606	20731762	3/8	9.5	11/16-16	7/8	22	LT		2.126	54.0	1.65	42.0	3.11	79.0	NS	Y
SG-OFFX90S-0606	29725-0606	20731760	3/8	9.5	11/16-16	7/8	22	ST		0.905	23.0	1.65	42.0	3.11	79.0	NS	Y
SG-OFFX90-0608	29715-0608	20821911	3/8	9.5	13/16-16	15/16	24			1.614	41.0	1.73	44.0	3.189	81.0	NS	Y
SG-OFFX90L-0608	29720-0608	20821904	3/8	9.5	13/16-16	15/16	24	LT		2.52	64.0	1.85	47.0	3.307	84.0	NS	Y
SG-OFFX90S-0608	29725-0608	20821899	3/8	9.5	13/16-16	15/16	24	ST		1.142	29.0	1.65	42.0	3.11	79.0	NS	Y
SG-OFFX90-0808	29715-0808	20731753	1/2	12.7	13/16-16	15/16	24			1.61	41.0	1.41	35.9	2.95	74.9	NS	Y
SG-OFFX90L-0808	29720-0808	20821903	1/2	12.7	13/16-16	15/16	24	LT		2.52	64.0	1.53	38.9	3.07	77.9	NS	Y
SG-OFFX90S-0808	29725-0808	20731756	1/2	12.7	13/16-16	15/16	24	ST		1.14	29.0	1.61	40.9	3.15	79.9	NS	Y
SG-OFFX90-0810		20821910	1/2	12.7	1-14	1 3/16	30			1.85	47.0	1.89	48.0	3.43	87.0	NS	Y
SG-OFFX90L-0810		20821902	1/2	12.7	1-14	1 3/16	30	LT		2.76	70.0	1.81	46.0	3.35	85.0	NS	Y
SG-OFFX90S-0810		20821898	1/2	12.7	1-14	1 3/16	30	ST		1.26	32.0	1.81	46.0	3.38	85.9	NS	Y
SG-OFFX90S-0812	29725-0812	20821897	1/2	12.7	1 3/16-12	1 7/16	36	ST		1.89	48.0	2.48	62.9	4.01	101.9	NS	Y
SG-OFFX90-1010		20821909	5/8	15.9	1-14	1 3/16	30			1.85	47.0	2.17	55.0	3.76	95.5	NS	Y
SG-OFFX90S-1010		20821896	5/8	15.9	1-14	1 3/16	30	ST		1.28	32.5	2.05	52.0	3.64	92.5	NS	Y
SG-OFFX90S-1012	29725-1012	20821895	5/8	15.9	1 3/16-12	1 7/16	36	ST		1.89	48.0	2.48	62.9	4.07	103.4	NS	Y
SG-OFFX90S-1210	29725-1210	20821894	3/4	19.0	1-14	1 3/16	30	ST		1.54	39.1	1.63	41.3	3.70	93.9	NS	Y
SG-OFFX90-1212	29715-1212	20821908	3/4	19.0	1 3/16-12	1 7/16	36			2.28	58.0	2.52	63.9	4.39	111.4	NS	Y
SG-OFFX90L-1212	29720-1212	20821901	3/4	19.0	1 3/16-12	1 7/16	36	LT		3.78	96.0	2.52	63.9	4.39	111.4	NS	Y
SG-OFFX90S-1212	29725-1212	20821893	3/4	19.0	1 3/16-12	1 7/16	36	ST		1.89	48.0	2.48	62.9	4.35	110.4	NS	Y
SG-OFFX90-1216	29715-1216	20821907	3/4	19.0	1 7/16-12	1 5/8	41			2.80	71.1	2.68	68.0	4.55	115.5	NS	Y
SG-OFFX90S-1216	29725-1216	20821892	3/4	19.0	1 7/16-12	1 5/8	41	ST		2.21	56.0	2.68	68.0	4.55	115.5	NS	Y
SG-OFFX90-1616	29715-1616	20821906	1	25.4	1 7/16-12	1 5/8	41			2.80	71.0	3.13	79.6	5.42	137.5	NS	Y
SG-OFFX90L-1616	29720-1616	20821900	1	25.4	1 7/16-12	1 5/8	41	LT		4.49	114.0	3.13	79.5	5.42	137.5	NS	Y
SG-OFFX90S-1616	29725-1616	20821891	1	25.4	1 7/16-12	1 5/8	41	ST		2.26	57.5	3.13	79.6	5.42	137.5	NS	Y
SG-OFFX90-1620		20821905	1	25.4	1 7/16-12	2	50			3.07	78.0	3.27	83.0	5.55	141.0	NS	Y
SG-OFFX90S-1620		20821890	1	25.4	1 7/16-12	2	50	ST		2.52	64.0	3.27	83.0	5.55	141.0	NS	Y

# O-Ring Face Seal (SAE J1453 ORS/ORFS)

Male

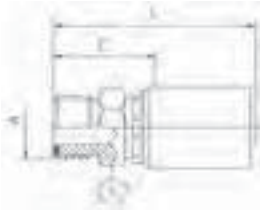

S=Skive  
NS=Non-Skive  
DG=Dual-Grip™

Descriptive #	Product #	SAP #	Hose Size ID		Thread Size (A)	Hex-1 Wrench Size		Cut-Off (C)		Length (L)		Skive Type	SR12, ARC12
			in.	mm		in.	mm	in.	mm	in.	mm		
S4-OFM-0606	28730-0606	20242182	3/8	9.5	11/16-16	3/4	19	0.96	24.3	2.01	51.0	NS	Y
S4-OFM-0608	28730-0608	20242184	3/8	9.5	13/16-16	7/8	22	1.04	26.3	2.09	53.0	NS	Y
S4-OFM-0808	28730-0808	20242175	1/2	12.7	13/16-16	7/8	22	1.07	27.1	2.31	58.6	NS	Y
S4-OFM-1212	28730-1212	20242168	3/4	19.0	1 3/16-12	1 1/4	32	1.36	34.6	2.92	74.1	NS	Y
S4-OFM-1216	28730-1216	20242180	3/4	19.0	1 7/16-12	1 1/2	41	1.50	38.1	3.06	77.6	NS	Y
S4-OFM-1616	28730-1616	20242170	1	25.4	1 7/16-12	1 1/2	38	1.49	37.9	3.25	82.5	NS	Y
S4-OFM-2020	28730-2020	20242171	1 1/4	31.8	1 11/16-12	1 13/16	46	1.63	41.5	3.68	93.5	NS	Y

Descriptive #	Product #	SAP #	Hose Size ID		Thread Size (A)	Hex-1 Wrench Size		Cut-Off (C)		Length (L)		Skive Type	SR12, ARC12
			in.	mm		in.	mm	in.	mm	in.	mm		
SG-OFM-0606	29730-0606	20758281	3/8	9.5	11/16-16	3/4	19	1.15	29.3	2.61	66.3	NS	Y
SG-OFM-0608	29730-0608	20821889	3/8	9.5	13/16-16	7/8	22	1.15	29.1	2.60	66.1	NS	Y
SG-OFM-0808	29730-0808	20758297	1/2	12.7	13/16-16	7/8	22	1.27	32.3	2.81	71.3	NS	Y
SG-OFM-0810	29730-0810	20821888	1/2	12.7	13/16-16	1 1/16	27	1.29	32.7	2.83	71.8	NS	Y
SG-OFM-0812	29730-0812	20821887	1/2	12.7	13/16-16	1 1/4	32	1.42	36.0	2.95	75.0	NS	Y
SG-OFM-1212	29730-1212	20821886	3/4	19.0	1 3/16-12	1 1/4	32	1.48	37.5	3.35	85.0	NS	Y
SG-OFM-1216	29730-1216	20821885	3/4	19.0	1 7/16-12	1 1/2	38	1.58	40.1	3.45	87.6	NS	Y
SG-OFM-1616	29730-1616	20821884	1	25.4	1 7/16-12	1 1/2	38	1.64	41.6	3.92	99.6	NS	Y

# O-Ring Boss Straight Thread (SAE J514)

Male

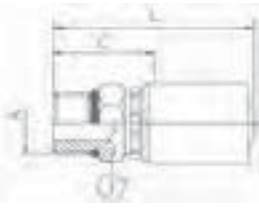

S=Skive  
NS=Non-Skive  
DG=Dual-Grip™

Descriptive #	Product #	SAP #	Hose Size ID		Thread Size (A)	Hex-1 Wrench Size		Cut-Off (C)		Length (L)		Skive Type	SR12, ARC12
			in.	mm	in.	mm	in.	mm	in.	mm			
S4-OBM-0808	28670-0808	20242130	1/2	12.7	3/4-16	7/8	22	0.99	25.1	2.23	56.6	NS	Y
S4-OBM-1212	28670-1212	20242124	3/4	19.0	1 1/16-12	1 1/4	32	1.28	32.6	2.84	72.1	NS	Y
S4-OBM-1216	28670-1216	20242119	3/4	19.0	1 5/16-12	1 1/2	38	1.36	34.6	2.92	74.1	NS	Y
S4-OBM-1616	28670-1616	20242125	1	25.4	1 5/16-12	1 1/2	38	1.39	35.4	3.15	80.0	NS	Y
S4-OBM-2020	28670-2020	20293258	1 1/4	31.8	1 5/8-12	1 3/4	46	1.54	39.0	3.58	91.0	NS	Y
S4-OBM-2424	28670-2424	20307206	1 1/2	38.1	2-12	1 5/8	50	1.60	24.6	3.92	60.4	NS	Y

Descriptive #	Product #	SAP #	Hose Size ID		Thread Size (A)	Hex-1 Wrench Size		Cut-Off (C)		Length (L)		Skive Type	SR12, ARC12
			in.	mm	in.	mm	in.	mm	in.	mm			
SG-OBM-0606	29670-0606	20821946	3/8	9.5	9/16-18	3/4	19	1.03	26.1	2.48	63.1	NS	Y
SG-OBM-0608	29670-0608	20821945	3/8	9.5	3/4-16	7/8	22	1.09	27.6	2.54	64.6	NS	Y
SG-OBM-0610	29670-0610	20821944	3/8	9.5	7/8-14	1 1/16	27	1.18	29.9	2.64	67.0	NS	Y
SG-OBM-0808	29670-0808	20821943	1/2	12.7	3/4-16	7/8	22	1.09	27.6	2.62	66.6	NS	Y
SG-OBM-0810	29670-0810	20821942	1/2	12.7	7/8-14	1 1/16	27	1.18	29.9	2.72	69.0	NS	Y
SG-OBM-0812	29670-0812	20821941	1/2	12.7	1 1/16-12	1 1/4	32	1.34	34.1	2.88	73.1	NS	Y
SG-OBM-1210	29670-1210	20821940	3/4	19.0	7/8-14	1 1/16	27	1.24	31.4	3.11	78.9	NS	Y
SG-OBM-1212	29670-1212	20821939	3/4	19.0	1 1/16-12	1 1/4	32	1.40	35.6	3.27	83.1	NS	Y
SG-OBM-1216	29670-1216	20821938	3/4	19.0	1 5/8-12	1 1/2	38	1.48	37.6	3.35	85.1	NS	Y
SG-OBM-1616	29670-1616	20821937	1	25.4	1 5/8-12	1 1/2	28	1.54	39.1	3.83	97.2	NS	Y

# Code 61 Flange (SAE J518)

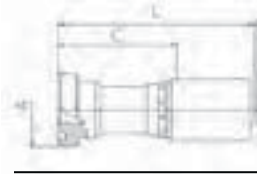

S=Skive  
NS=Non-Skive  
DG=Dual-Grip™

Descriptive #	Product #	SAP #	Hose Size ID		Flange Size	Flange Diameter (A)		Cut-Off (C)		Length (L)		Skive Type	SR12, ARC12
			in.	mm		in.	mm	in.	mm	in.	mm		
S4-FL-0808	28320-0808	20242907	1/2	12.7	1/2	1.19	30.2	1.61	41.0	2.85	72.5	NS	Y
S4-FL-0812	28320-0812	20242905	1/2	12.7	3/4	1.50	38.1	1.65	42.0	2.89	73.5	NS	Y
S4-FL-1012	28320-1012	20242898	5/8	15.9	3/4	1.50	38.1	1.66	42.2	3.01	76.5	NS	Y
S4-FL-1212	28320-1212	20242900	3/4	19.0	3/4	1.50	38.1	1.67	42.5	3.23	82.0	NS	Y
S4-FL-1216	28320-1216	20242912	3/4	19.0	1	1.75	44.5	1.99	50.5	3.54	90.0	NS	Y
S4-FL-1220	28320-1220	20441320	3/4	19.0	1¼	2.00	50.8	2.09	53.0	3.64	92.5	NS	Y
S4-FL-1616	28320-1616	20242878	1	25.4	1	1.75	44.5	2.02	51.4	3.78	96.0	NS	Y
S4-FL-1620	28320-1620	20242904	1	25.4	1¼	2.00	50.8	2.12	53.9	3.88	98.5	NS	Y
S4-FL-1624	28320-1624	20293264	1	25.4	1½	2.37	60.3	2.24	57.0	4.00	101.5	NS	Y
S4-FL-2020	28320-2020	20242909	1¼	31.8	1¼	2.00	50.8	2.19	55.5	4.23	107.5	NS	Y
S4-FL-2024	28320-2024	20242910	1¼	31.8	1½	2.37	60.3	2.30	58.5	4.35	110.5	NS	Y
S4-FL-2424	28320-2424	20242886	1½	38.1	1½	2.37	60.3	2.31	58.8	4.63	117.5	NS	Y
S4-FL-2432	28320-2432	20242911	1½	38.1	2	2.81	71.4	2.76	70.0	5.08	129.0	NS	Y
S4-FL-3232	28320-3232	20242895	2	50.8	2	2.81	71.4	2.76	70.0	5.59	142.0	NS	Y

Descriptive #	Product #	SAP #	Hose Size ID		Flange Size	Flange Diameter (A)		Cut-Off (C)		Length (L)		Skive Type	SR12, ARC12
			in.	mm		in.	mm	in.	mm	in.	mm		
SG-FL-0808	29320-0808	20822104	1/2	12.7	1/2	1.19	30.2	1.61	40.9	3.15	79.9		Y
SG-FL-0812	29320-0812	20822131	1/2	12.7	3/4	1.50	38.1	1.65	41.9	3.19	80.9		Y
SG-FL-1012	29320-1012	20822102	5/8	15.9	3/4	1.50	38.1	1.71	43.3	3.30	83.8		Y
SG-FL-1212	29320-1212	20822098	3/4	19.0	3/4	1.50	38.1	1.75	44.3	3.62	91.8		Y
SG-FL-1216	29320-1216	20822097	3/4	19.0	1	1.75	44.5	1.99	50.5	3.86	98.0		Y
SG-FL-1220	29320-1220	20822096	3/4	19.0	1¼	2.00	50.8	2.09	53.0	3.96	100.6		Y
SG-FL-1616	29320-1616	20822094	1	25.4	1	1.75	44.5	2.09	53.1	4.37	111.1		Y
SG-FL-1620	29320-1620	20822093	1	25.4	1¼	2.00	50.8	2.12	53.9	4.40	111.8		Y
SG-FL-1624	29320-1624	20822092	1	25.4	1½	2.37	60.3	2.32	58.9	4.60	116.8		Y

## Code 61 Flange (SAE J518)

22.5° Elbow

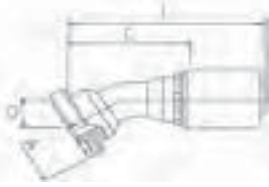

S=Skive  
NS=Non-Skive  
DG=Dual-Grip™

Descriptive #	Product #	SAP #	Hose Size ID		Flange Size	Flange Diameter (A)		Drop (D)		Cut-Off (C)		Length (L)		Skive Type	SR12, ARC12
			in.	mm		in.	mm	in.	mm	in.	mm	in.	mm		
S4-FL22-0808	28330-0808	20441293	1/2	12.7	1/2	1.19	30.2	0.35	9.0	2.32	59.0	3.58	91.0	NS	Y
S4-FL22-1212	28330-1212	20441202	3/4	19.0	3/4	1.50	38.1	0.83	21.0	3.90	99.0	5.47	139.0	NS	Y
S4-FL22-1216	28330-1216	20441276	3/4	19.0	1	1.75	44.5	0.51	13.0	3.39	86.0	4.96	126.0	NS	Y
S4-FL22-1616	28330-1616	20242929	1	25.4	1	1.75	44.5	0.47	12.0	3.66	93.0	5.39	137.0	NS	Y
S4-FL22-1620	28330-1620	20293265	1	25.4	1¼	2.00	50.8	0.63	16.0	3.62	92.0	5.39	137.0	NS	Y
S4-FL22-2020	28330-2020	20242928	1¼	31.8	1¼	2.00	50.8	0.63	16.0	4.49	114.0	6.54	166.0	NS	Y
S4-FL22-2024	28330-2024	20293266	1¼	31.8	1½	2.37	60.3	0.81	20.5	4.53	115.0	6.57	167.0	NS	Y
S4-FL22-2424	28330-2424	20242923	1½	38.1	1½	2.37	60.3	0.65	16.5	5.16	131.0	7.48	190.0	NS	Y
S4-FL22-3232	28330-3232	20293267	2	50.8	2	2.81	71.4	0.87	22.0	6.02	153.0	8.86	225.0	NS	Y

Descriptive #	Product #	SAP #	Hose Size ID		Flange Size	Flange Diameter (A)		Drop (D)		Cut-Off (C)		Length (L)		Skive Type	SR12, ARC12
			in.	mm		in.	mm	in.	mm	in.	mm	in.	mm		
SG-FL22-0808	29330-0808	20822091	1/2	12.7	1/2	1.19	30.2	0.35	9.0	2.32	58.9	3.86	97.9	NS	Y
SG-FL22-1212	29330-1212	20822090	3/4	19.0	3/4	1.50	38.1	0.55	14.0	3.3	84.5	5.20	132.0	NS	Y
SG-FL22-1216	29330-1216	20822089	3/4	19.0	1	1.75	44.5	0.55	14.0	3.39	86.1	5.26	133.6	NS	Y
SG-FL22-1616	29330-1616	20822088	1	25.4	1	1.75	44.5	0.55	14.0	4.22	107.1	6.50	165.1	NS	Y
SG-FL22-1620	29330-1620	20822087	1	25.4	1¼	2.00	50.8	0.59	15.0	3.62	91.9	5.90	149.9	NS	Y

## Code 61 Flange (SAE J518)

30° Elbow

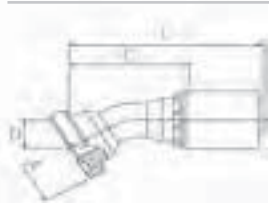

S=Skive  
NS=Non-Skive  
DG=Dual-Grip™

Descriptive #	Product #	SAP #	Hose Size ID		Flange Size	Flange Diameter (A)		Drop (D)		Cut-Off (C)		Length (L)		Skive Type	SR12, ARC12
			in.	mm		in.	mm	in.	mm	in.	mm	in.	mm		
S4-FL30-1212	28335-1212	20242920	3/4	19.0	3/4	1.50	38.1	0.75	19.0	3.19	81.0	4.72	120.0	NS	Y
S4-FL30-1216	28335-1216	20242932	3/4	19.0	1	1.75	44.5	0.75	19.0	3.31	84.0	4.84	123.0	NS	Y
S4-FL30-1616	28335-1616	20242926	1	25.4	1	1.75	44.5	0.83	21.0	3.54	90.0	5.28	134.0	NS	Y
S4-FL30-1620	28335-1620	20242925	1	25.4	1¼	2.00	50.8	0.87	22.0	3.54	90.0	5.31	135.0	NS	Y
S4-FL30-1624	28335-1624	20293268	1	25.4	1½	2.37	60.3	1.06	27.0	4.13	105.0	5.87	149.0	NS	Y

Continued on next page

# Code 61 Flange (SAE J518)

## 30° Elbow Continued

Descriptive #	Product #	SAP #	Hose Size ID		Flange Size	Flange Diameter (A)		Drop (D)		Cut-Off (C)		Length (L)		Skive Type	SR12, ARC12
			in.	mm		in.	mm	in.	mm	in.	mm	in.	mm		
S4-FL30-2020	28335-2020	20242922	1¼	31.8	1¼	2.00	50.8	0.98	25.0	4.02	102.0	6.06	154.0	NS	Y
S4-FL30-2024	28335-2024	20242913	1¼	31.8	1½	2.37	60.3	1.06	27.0	4.41	112.0	6.46	164.0	NS	Y
S4-FL30-2424	28335-2424	20242924	1½	38.1	1½	2.37	60.3	0.91	23.0	5.35	136.0	7.68	195.0	NS	Y
S4-FL30-2432	28335-2432	20293269	1½	38.1	2	2.81	71.4	1.44	36.5	5.91	150.0	8.23	209.0	NS	Y
S4-FL30-3232	28335-3232	20293270	2	50.8	2	2.81	71.4	1.18	30.0	5.87	149.0	8.70	221.0	NS	Y

Descriptive #	Product #	SAP #	Hose Size ID		Flange Size	Flange Diameter (A)		Drop (D)		Cut-Off (C)		Length (L)		Skive Type	SR12, ARC12
			in.	mm		in.	mm	in.	mm	in.	mm	in.	mm		
SG-FL30-1212	29335-1212	20822086	3/4	19.0	3/4	1.50	38.1	0.69	17.5	3.23	81.9	5.14	130.5	NS	Y
SG-FL30-1216	29335-1216	20822085	3/4	19.0	1	1.75	44.5	0.75	19.0	3.31	84.1	5.18	131.6	NS	Y
SG-FL30-1616	29335-1616	20822084	1	25.4	1	1.75	44.5	0.75	19.0	4.15	105.4	6.43	163.4	NS	Y
SG-FL30-1620	29335-1620	20822083	1	25.4	1¼	2.00	50.8	0.87	22.0	3.54	89.9	5.82	147.9	NS	Y
SG-FL30-1624	29335-1624	20822082	1	25.4	1½	2.37	60.3	1.06	27.0	4.21	107.0	6.50	165.0	NS	Y

# Code 61 Flange (SAE J518)

## 45° Elbow

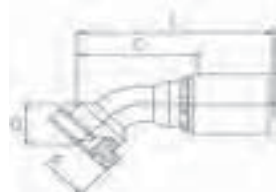

S=Skive  
NS=Non-Skive  
DG=Dual-Grip™

Descriptive #	Product #	SAP #	Hose Size ID		Flange Size (A)	Flange Diameter (A)		Drop (D)		Cut-Off (C)		Length (L)		Skive Type	SR12, ARC12
			in.	mm		in.	mm	in.	mm	in.	mm	in.	mm		
S4-FL45-0808	28340-0808	20242950	1/2	12.7	1/2	1.19	30.2	0.87	22.0	2.09	53.0	3.31	84.0	NS	Y
S4-FL45-0812	28340-0812	20242946	1/2	12.7	3/4	1.50	38.1	1.02	26.0	2.36	60.0	3.62	92.0	NS	Y
S4-FL45-1012	28340-1012	20441203	5/8	15.9	3/4	1.50	38.1	1.02	26.0	2.56	65.0	3.90	99.0	NS	Y
S4-FL45-1212	28340-1212	20242948	3/4	19.0	3/4	1.50	38.1	1.26	32.0	2.91	74.0	4.45	113.0	NS	Y
S4-FL45-1216	28340-1216	20242943	3/4	19.0	1	1.75	44.5	1.14	29.0	3.07	78.0	4.61	117.0	NS	Y
S4-FL45-1616	28340-1616	20242918	1	25.4	1	1.75	44.5	1.32	33.5	3.27	83.0	5.00	127.0	NS	Y
S4-FL45-1620	28340-1620	20242916	1	25.4	1¼	2.00	50.8	1.42	36.0	3.23	82.0	5.00	127.0	NS	Y
S4-FL45-2020	28340-2020	20242934	1¼	31.8	1¼	2.00	50.8	1.48	37.5	3.74	95.0	5.79	147.0	NS	Y
S4-FL45-2024	28340-2024	20242921	1¼	31.8	1½	2.37	60.3	1.57	40.0	4.09	104.0	6.14	156.0	NS	Y
S4-FL45-2424	28340-2424	20242915	1½	38.1	1½	2.37	60.3	1.89	48.0	4.61	117.0	6.93	176.0	NS	Y
S4-FL45-2432	28340-2432	20242914	1½	38.1	2	2.81	71.4	2.19	55.5	5.35	136.0	7.68	195.0	NS	Y
S4-FL45-3232	28340-3232	20242945	2	50.8	2	2.81	71.4	1.87	47.5	5.55	141.0	8.39	213.0	NS	Y

Continued on next page

## Code 61 Flange (SAE J518)

## 45° Elbow Continued

Descriptive #	Product #	SAP #	Hose Size ID		Flange Size (A)	Flange Diameter (A)		Drop (D)		Cut-Off (C)		Length (L)		Skive Type	SR12, ARC12
			in.	mm		in.	mm	in.	mm	in.	mm	in.	mm		
SG-FL45-0808	29340-0808	20822081	1/2	12.7	1/2	1.19	30.2	0.80	20.3	2.24	56.9	3.78	95.9	NS	Y
SG-FL45-0812	29340-0812	20822080	1/2	12.7	3/4	1.50	38.1	1.02	26.0	2.99	75.8	4.52	114.8	NS	Y
SG-FL45-1012	29340-1012	20822079	5/8	15.9	3/4	1.50	38.1	1.02	26.0	2.56	65.0	4.15	105.5	NS	Y
SG-FL45-1212	29340-1212	20822078	3/4	19.0	3/4	1.50	38.1	1.02	26.0	2.99	75.8	4.86	123.3	NS	Y
SG-FL45-1216	29340-1216	20822077	3/4	19.0	1	1.75	44.5	1.26	32.0	3.07	78.0	4.94	125.5	NS	Y
SG-FL45-1616	29340-1616	20822076	1	25.4	1	1.75	44.5	1.26	32.0	3.84	97.6	6.13	155.6	NS	Y
SG-FL45-1620	29340-1620	20822075	1	25.4	1¼	2.00	50.8	1.50	38.0	3.23	82.0	5.51	140.0	NS	Y

## Code 61 Flange (SAE J518)

## 60° Elbow

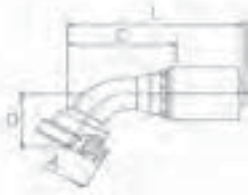

S=Skive  
NS=Non-Skive  
DG=Dual-Grip™

Descriptive #	Product #	SAP #	Hose Size ID		Flange Size	Flange Diameter (A)		Drop (D)		Cut-Off (C)		Length (L)		Skive Type	SR12, ARC12
			in.	mm		in.	mm	in.	mm	in.	mm	in.	mm		
S4-FL60-1212	28345-1212	20242935	3/4	19.0	3/4	1.50	38.1	1.46	37.0	3.39	86.0	4.92	125.0	NS	Y
S4-FL60-1216	28345-1216	20242940	3/4	19.0	1	1.75	44.5	1.73	44.0	4.02	102.0	5.57	141.5	NS	Y
S4-FL60-1616	28345-1616	20242941	1	25.4	1	1.75	44.5	1.85	47.0	3.98	101.0	5.73	145.6	NS	Y
S4-FL60-1620	28345-1620	20242933	1	25.4	1¼	2.00	50.8	1.71	43.5	4.20	106.6	5.95	151.2	NS	Y
S4-FL60-2020	28345-2020	20242937	1¼	31.8	1¼	2.00	50.8	2.22	56.5	5.10	129.5	7.15	181.5	NS	Y
S4-FL60-2024	28345-2024	20293271	1¼	31.8	1½	2.37	60.3	2.28	58.0	5.31	135.0	7.36	187.0	NS	Y
S4-FL60-2424	28345-2424	20293272	1½	38.1	1½	2.37	60.3	2.24	57.0	5.98	152.0	8.31	211.0	NS	Y
S4-FL60-2432	28345-2432	20293273	1½	38.1	2	2.81	71.4	3.05	77.5	6.52	165.5	8.84	224.5	NS	Y
S4-FL60-3232	28345-3232	20293274	2	50.8	2	2.81	71.4	3.62	92.0	6.81	173.0	9.65	245.0	NS	Y

Descriptive #	Product #	SAP #	Hose Size ID		Flange Size	Flange Diameter (A)		Drop (D)		Cut-Off (C)		Length (L)		Skive Type	SR12, ARC12
			in.	mm		in.	mm	in.	mm	in.	mm				
SG-FL60-1212	29345-1212	20822074	3/4	19.0	3/4	1.50	38.1	1.46	37.1	3.47	88.0	5.34	135.5	NS	Y
SG-FL60-1216	29345-1216	20822073	3/4	19.0	1	1.75	44.5	1.73	44.0	3.46	87.9	5.33	135.4	NS	Y
SG-FL60-1616	29345-1616	20822072	1	25.4	1	1.75	44.5	1.73	44.0	4.15	105.4	6.43	163.4	NS	Y
SG-FL60-1620	29345-1620	20822071	1	25.4	1¼	2.00	50.8	2.17	55.0	4.20	106.7	6.48	164.7	NS	Y



## Code 61 Flange (SAE J518)

67° Elbow



S=Skive  
NS=Non-Skive  
DG=Dual-Grip™

Descriptive #	Product #	SAP #	Hose Size ID		Flange Size	Flange Diameter (A)		Drop (D)		Cut-Off (C)		Length (L)		Skive Type	SR12, ARC12
			in.	mm		in.	mm	in.	mm	in.	mm	in.	mm		
S4-FL67-1212	28347-1212	20293275	3/4	19.0	3/4	1.50	38.1	1.79	45.5	3.09	78.5	4.65	118.0	NS	Y
S4-FL67-1216	28347-1216	20441294	3/4	19.0	1	1.75	44.4	2.01	51.0	3.46	88.0	5.00	127.0	NS	Y
S4-FL67-1616	28347-1616	20293276	1	25.4	1	1.75	44.4	1.95	49.5	3.68	93.4	5.43	138.0	NS	Y
S4-FL67-1620	28347-1620	20293277	1	25.4	1¼	2.00	50.8	2.11	53.5	3.88	98.5	5.63	143.0	NS	Y
S4-FL67-2020	28347-2020	20293278	1¼	31.8	1¼	2.00	50.8	2.46	62.5	4.72	120.0	6.77	172.0	NS	Y
S4-FL67-2024	28347-2024	20293279	1¼	31.8	1½	2.37	60.3	2.58	65.5	4.78	121.4	6.83	173.5	NS	Y
S4-FL67-2424	28347-2424	20293280	1½	38.1	1½	2.37	60.3	2.58	65.5	5.33	135.5	7.66	194.5	NS	Y
S4-FL67-2432	28347-2432	20293281	1½	38.1	2	2.81	71.4	3.46	88.0	5.55	141.0	7.87	200.0	NS	Y
S4-FL67-3232	28347-3232	20293282	2	50.8	2	2.81	71.4	3.76	95.5	7.05	179.0	9.88	251.0	NS	Y

Descriptive #	Product #	SAP #	Hose Size ID		Flange Size	Flange Diameter (A)		Drop (D)		Cut-Off (C)		Length (L)		Skive Type	SR12, ARC12
			in.	mm		in.	mm	in.	mm	in.	mm	in.	mm		
SG-FL67-1212	29347-1212	20822070	3/4	19.0	3/4	1.50	38.1	1.65	42.0	3.17	80.4	5.04	127.9	NS	Y
SG-FL67-1216	29347-1216	20822069	3/4	19.0	1	1.75	44.4	2.01	51.0	3.46	87.9	5.33	135.4	NS	Y
SG-FL67-1616	29347-1616	20822068	1	25.4	1	1.75	44.4	2.40	61.0	3.84	97.6	6.13	155.6	NS	Y
SG-FL67-1620	29347-1620	20822067	1	25.4	1¼	2.00	50.8	2.52	64.0	3.88	98.6	6.16	156.5	NS	Y

## Code 61 Flange (SAE J518)

90° Elbow

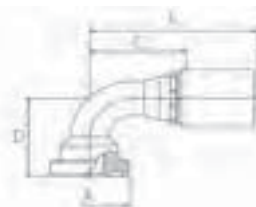

Descriptive #	Product #	SAP #	Hose Size ID		Flange Size	Flange Diameter (A)		Drop (D)		Cut-Off (C)		Length (L)		Skive Type	SR12, ARC12
			in.	mm		in.	mm	in.	mm	in.	mm	in.	mm		
S4-FL90-0808	28350-0808	20242887	1/2	12.7	1/2	1.19	30.2	1.65	42.0	1.81	46.0	3.03	77.0	NS	Y
S4-FL90-0812	28350-0812	20242885	1/2	12.7	3/4	1.50	38.1	2.01	51.0	1.77	45.0	3.03	77.0	NS	Y
S4-FL90-1212	28350-1212	20242880	3/4	19.0	3/4	1.50	38.1	2.36	60.0	2.28	58.0	3.82	97.0	NS	Y
S4-FL90-1216	28350-1216	20242882	3/4	19.0	1	1.75	44.5	2.54	64.5	2.60	66.0	4.17	106.0	NS	Y
S4-FL90L-1216*	28352-1216	20293284	3/4	19.0	1	1.75	44.5	3.15	80.0	2.60	66.0	4.17	106.0	NS	Y

\*Drop Length does not meet SAE long drop dimensions

Continued on next page

## Code 61 Flange (SAE J518)

## 90° Elbow Continued

Descriptive #	Product #	SAP #	Hose Size ID		Flange Size	Flange Diameter (A)		Drop (D)		Cut-Off (C)		Length (L)		Skive Type	SR12, ARC12
			in.	mm		in.	mm	in.	mm	in.	mm	in.	mm		
S4-FL90-1612	28350-1612	20293285	1	25.4	3/4	1.50	38.1	2.17	55.0	2.64	67.0	4.41	112.0	NS	Y
S4-FL90-1616	28350-1616	20242896	1	25.4	1	1.75	44.5	2.64	67.0	2.80	71.0	4.53	115.0	NS	Y
S4-FL90L-1616	28352-1616	20293286	1	25.4	1	1.75	44.5	4.92	125.0	2.95	75.0	4.69	119.0	NS	Y
S4-FL90-1620	28350-1620	20242892	1	25.4	1¼	2.00	50.8	2.80	71.0	2.91	74.0	4.65	118.0	NS	Y
S4-FL90-1624	28350-1624	20293287	1	25.4	1½	2.37	60.3	2.95	75.0	3.66	93.0	5.43	138.0	NS	Y
S4-FL90-2016	28350-2016	20242897	1¼	31.8	1	1.75	44.5	2.56	65.0	3.70	94.0	5.75	146.0	NS	Y
S4-FL90-2020	28350-2020	20242931	1¼	31.8	1¼	2.00	50.8	3.31	84.0	3.46	88.0	5.51	140.0	NS	Y
S4-FL90-2024	28350-2024	20242889	1¼	31.8	1½	2.37	60.3	3.44	87.5	3.58	91.0	5.63	143.0	NS	Y
S4-FL90-2424	28350-2424	20242891	1½	38.1	1½	2.37	60.3	3.58	91.0	4.13	105.0	6.46	164.0	NS	Y
S4-FL90-2432	28350-2432	20242890	1½	38.1	2	2.81	71.4	4.53	115.0	4.13	105.0	6.46	164.0	NS	Y
S4-FL90-3232	28350-3232	20242894	2	50.8	2	2.81	71.4	5.12	130.0	5.08	129.0	7.91	201.0	NS	Y

Descriptive #	Product #	SAP #	Hose Size ID		Flange Size	Flange Diameter (A)		Drop (D)		Cut-Off (C)		Length (L)		Skive Type	SR12, ARC12
			in.	mm		in.	mm	in.	mm	in.	mm	in.	mm		
SG-FL90-0808	29350-0808	20758301	1/2	12.7	1/2	1.19	30.2	1.63	41.5	1.89	48.0	3.43	87.0	NS	Y
SG-FL90-0812	29350-0812	20822066	1/2	12.7	3/4	1.50	38.1	2.28	58.0	1.89	48.0	3.43	87.0	NS	Y
SG-FL90-1212	29350-1212	20822065	3/4	19.0	3/4	1.50	38.1	2.28	58.0	2.36	59.8	4.23	107.3	NS	Y
SG-FL90-1216	29350-1216	20822064	3/4	19.0	1	1.75	44.5	2.76	70.0	2.60	66.0	4.47	113.5	NS	Y
SG-FL90L-1216	29352-1216	20822059	3/4	19.0	1	1.75	44.5	6.06	154.0	2.60	66.0	4.47	113.5	NS	Y
SG-FL90-1612	29350-1612	20822063	1	25.4	3/4	1.50	38.1	2.28	58.0	2.63	66.7	4.91	124.7	NS	Y
SG-FL90-1616	29350-1616	20822062	1	25.4	1	1.75	44.5	2.76	70.1	2.97	75.4	5.25	133.4	NS	Y
SG-FL90L-1616	29352-1616	20822058	1	25.4	1	1.75	44.5	6.06	154.0	3.97	100.8	6.25	158.8	NS	Y
SG-FL90-1620	29350-1620	20822061	1	25.4	1¼	2.00	50.8	3.54	90.0	3.07	78.0	5.35	136.0	NS	Y
SG-FL90-1624	29350-1624	20822060	1	25.4	1½	2.37	60.3	2.95	75.0	3.74	95.0	6.02	153.0	NS	Y

## Code 61 Flange (SAE J518)

## 110° Elbow

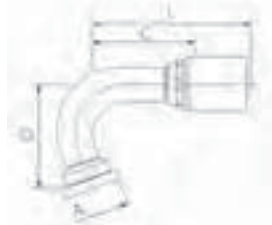

S=Skive  
NS=Non-Skive  
DG=Dual-Grip™

Descriptive #	Product #	SAP #	Hose Size ID		Flange Size (A)	Flange Diameter (A)		Drop (D)		Cut-Off (C)		Length (L)		Skive Type	SR12, ARC12
			in.	mm		in.	mm	in.	mm	in.	mm	in.	mm		
S4-FL110-1212	28354-1212	20441316	3/4	19.0	3/4	1.50	38.1	2.76	70.0	2.44	62.0	4.02	102.0	NS	Y
S4-FL110-1216	28354-1216	20441317	3/4	19.0	1	1.75	44.5	2.91	74.0	2.24	57.0	3.82	97.0	NS	Y
S4-FL110-1616	28354-1616	20441318	1	25.4	1	1.75	44.5	3.11	79.0	3.74	95.0	5.51	140.0	NS	Y
S4-FL110-2424	28354-2424	20441319	1½	38.1	1½	2.37	60.3	4.33	110.0	3.74	95.0	6.06	154.0	NS	Y

Continued on next page

## Code 61 Flange (SAE J518)

110° Elbow Continued

Descriptive #	Product #	SAP #	Hose Size ID		Flange Size	Flange Diameter (A)		Drop (D)		Cut-Off (C)		Length (L)		Skive Type	SR12, ARC12
			in.	mm		in.	mm	in.	mm	in.	mm	in.	mm		
SG-FL110-1212	29354-1212	20822101	3/4	19.0	3/4	1.50	38.1	2.76	70.1	2.52	63.9	4.39	111.4	NS	Y
SG-FL110-1216	29354-1216	20822100	3/4	19.0	1	1.75	44.5	2.91	73.9	2.25	57.2	4.12	104.6	NS	Y
SG-FL110-1616	29354-1616	20822099	1	25.4	1	1.75	44.5	3.11	79.0	3.81	96.8	6.09	154.8	NS	Y

## Code 61 Flange (SAE J518)

135° Elbow

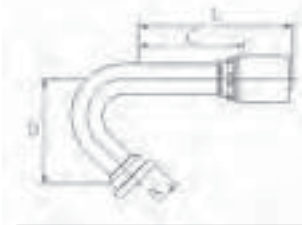

S=Skive  
NS=Non-Skive  
DG=Dual-Grip™

Descriptive #	Product #	SAP #	Hose Size ID		Flange Size	Flange Diameter (A)		Drop (D)		Cut-Off (C)		Length (L)		Skive Type	SR12, ARC12
			in.	mm		in.	mm	in.	mm	in.	mm	in.	mm		
S4-FL135-1212	28355-1212	20477377	3/4	19.0	3/4	1.50	38.1	3.15	80.0	2.95	75.0	4.49	114.0	NS	Y

Descriptive #	Product #	SAP #	Hose Size ID		Flange Size	Flange Diameter (A)		Drop (D)		Cut-Off (C)		Length (L)		Skive Type	SR12, ARC12
			in.	mm		in.	mm	in.	mm	in.	mm	in.	mm		
SG-FL135-1212	29355-1212	20822095	3/4	19.0	3/4	1.50	38.1	3.15	80.0	2.83	71.8	4.70	119.3	NS	Y

## Code 62 Flange (SAE J518)



S=Skive  
NS=Non-Skive  
DG=Dual-Grip™

Descriptive #	Product #	SAP #	Hose Size ID		Flange Size	Flange Diameter (A)		Cut-Off (C)		Length (L)		Skive Type	SR12, ARC12
			in.	mm		in.	mm	in.	mm	in.	mm		
S4-FH-0808	28300-0808	20241741	1/2	12.7	1/2	1.25	31.8	1.85	47.0	3.09	78.5	NS	Y
S4-FH-0812	28300-0812	20241750	1/2	12.7	3/4	1.63	41.3	2.05	52.0	3.29	83.5	NS	Y
S4-FH-1212	28300-1212	20241753	3/4	19.0	3/4	1.63	41.3	2.07	52.5	3.62	92.0	NS	Y
S4-FH-1216	28300-1216	20241747	3/4	19.0	1	1.87	47.6	2.19	55.5	3.74	95.0	NS	Y
S4-FH-1612	28300-1612	20293288	1	25.4	3/4	1.63	41.3	2.22	56.4	3.98	101.0	NS	Y
S4-FH-1616	28300-1616	20241730	1	25.4	1	1.87	47.6	2.22	56.4	3.98	101.0	NS	Y
S4-FH-1620	28300-1620	20241218	1	25.4	1 1/4	2.13	54.0	2.50	63.4	4.25	108.0	NS	Y

Continued on next page

## Code 62 Flange (SAE J518)

Continued

Descriptive #	Product #	SAP #	Hose Size ID		Flange Size	Flange Diameter (A)		Cut-Off (C)		Length (L)		Skive Type	SR12, ARC12
			in.	mm		in.	mm	in.	mm	in.	mm		
S4-FH-2016	28300-2016	20441292	1¼	31.8	1	1.87	47.6	3.27	83.0	5.31	135.0	NS	Y
S4-FH-2020	28300-2020	20241752	1¼	31.8	1¼	2.13	54.0	3.27	83.0	5.31	135.0	NS	Y
S4-FH-2024	28300-2024	20241754	1¼	31.8	1½	2.50	63.5	2.80	71.0	4.84	123.0	NS	Y
S4-FH-2424	28300-2424	20241751	1½	38.1	1½	2.50	63.5	3.74	95.0	6.06	154.0	NS	Y
S4-FH-2432	28300-2432	20241757	1½	38.1	2	3.13	79.4	2.99	76.0	5.31	135.0	NS	Y
S4-FH-3232	28300-3232	20241759	2	50.8	2	3.13	79.4	2.99	76.0	5.83	148.0	NS	Y

Descriptive #	Product #	SAP #	Hose Size ID		Flange Size	Flange Diameter (A)		Cut-Off (C)		Length (L)		Skive Type	SR12, ARC12
			in.	mm		in.	mm	in.	mm	in.	mm		
SG-FH-0808	29300-0808	20822132	1/2	12.7	1/2	1.25	31.8	1.88	47.7	3.41	86.7	NS	Y
SG-FH-0812	29300-0812	20822131	1/2	12.7	3/4	1.63	41.3	2.08	52.8	3.62	91.8	NS	Y
SG-FH-1212	29300-1212	20822130	3/4	19.0	3/4	1.63	41.3	2.15	54.5	4.02	102.0	NS	Y
SG-FH-1216	29300-1216	20822129	3/4	19.0	1	1.87	47.6	2.24	56.8	4.11	104.3	NS	Y
SG-FH-1612	29300-1612	20822128	1	25.4	3/4	1.63	41.3	2.30	58.4	4.58	116.4	NS	Y
SG-FH-1616	29300-1616	20822127	1	25.4	1	1.87	47.6	2.28	58.0	4.57	116.0	NS	Y
SG-FH-1620	29300-1620	20822126	1	25.4	1¼	2.13	54.0	2.58	65.5	4.86	123.5	NS	Y

## Code 62 Flange (SAE J518)

22.5° Elbow

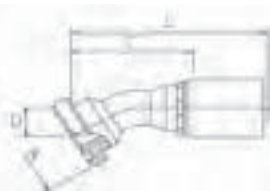

S=Skive  
NS=Non-Skive  
DG=Dual-Grip™

Descriptive #	Product #	SAP #	Hose Size ID		Flange Size	Flange Diameter (A)		Drop (D)	Cut-Off (C)		Length (L)		Skive Type	SR12, ARC12	
			in.	mm		in.	mm		in.	mm	in.	mm			
S4-FH22-1212	28303-1212	20293289	3/4	19.0	3/4	1.63	41.3	0.55	14.0	3.66	93.0	5.22	132.5	NS	Y
S4-FH22-1616	28303-1616	20293290	1	25.4	1	1.87	47.6	0.63	16.0	4.19	106.5	5.94	151.0	NS	Y
S4-FH22-2020	28303-2020	20293291	1¼	31.8	1¼	2.13	54.0	0.69	17.5	4.72	120.0	6.77	172.0	NS	Y
S4-FH22-2024	28303-2024	20293292	1¼	31.8	1½	2.50	63.5	0.81	20.5	5.04	128.0	7.09	180.0	NS	Y

Descriptive #	Product #	SAP #	Hose Size ID		Flange Size	Flange Diameter (A)		Drop (D)	Cut-Off (C)		Length (L)		Skive Type	SR12, ARC12	
			in.	mm		in.	mm		in.	mm	in.	mm			
SG-FH22-1212	29303-1212	20822125	3/4	19.0	3/4	1.63	41.3	0.55	14.0	3.33	84.5	5.20	132.0	NS	Y
SG-FH22-1216	29303-1216	20822124	3/4	19.0	1	1.87	47.6	0.59	15.0	3.39	86.1	5.26	133.6	NS	Y
SG-FH22-1616	29303-1616	20822123	1	25.4	1	1.87	47.6	0.55	14.0	4.22	107.1	6.50	165.1	NS	Y

## Code 62 Flange (SAE J518)

30° Elbow



S=Skive  
NS=Non-Skive  
DG=Dual-Grip™

Descriptive #	Product #	SAP #	Hose Size ID		Flange Size	Flange Diameter (A)		Drop (D)		Cut-Off (C)		Length (L)		Skive Type	SR12, ARC12
			in.	mm		in.	mm	in.	mm	in.	mm	in.	mm		
S4-FH30-1212	28305-1212	20293293	3/4	19.0	3/4	1.63	41.3	0.77	19.5	3.48	88.5	5.04	128.0	NS	Y
S4-FH30-1616	28305-1616	20293294	1	25.4	1	1.87	47.6	0.89	22.5	4.11	104.5	5.87	149.0	NS	Y
S4-FH30-2020	28305-2020	20293295	1¼	31.8	1¼	2.13	54.0	0.96	24.5	4.61	117.0	6.65	169.0	NS	Y
S4-FH30-2024	28305-2024	20293296	1¼	31.8	1½	2.50	63.5	1.12	28.5	4.90	124.5	6.95	176.5	NS	Y
S4-FH30-2424	28305-2424	20293297	1½	38.1	1½	2.50	63.5	1.08	27.5	5.22	132.5	7.54	191.5	NS	Y
S4-FH30-3232	28305-3232	20293298	2	50.8	2	3.13	79.4	1.44	36.5	6.65	169.0	9.49	241.0	NS	Y

Descriptive #	Product #	SAP #	Hose Size ID		Flange Size	Flange Diameter (A)		Drop (D)		Cut-Off (C)		Length (L)		Skive Type	SR12, ARC12
			in.	mm		in.	mm	in.	mm	in.	mm				
SG-FH30-1212	29305-1212	20822122	3/4	19.0	3/4	1.63	41.3	0.73	18.5	3.27	83.0	5.14	130.5	NS	Y
SG-FH30-1616	29305-1616	20822121	1	25.4	1	1.87	47.6	0.75	19.0	4.15	105.4	6.43	163.4	NS	Y

## Code 62 Flange (SAE J518)

45° Elbow



S=Skive  
NS=Non-Skive  
DG=Dual-Grip™

Descriptive #	Product #	SAP #	Hose Size ID		Flange Size	Flange Diameter (A)		Drop (D)		Cut-Off (C)		Length (L)		Skive Type	SR12, ARC12
			in.	mm		in.	mm	in.	mm	in.	mm				
S4-FH45-0808	28310-0808	20241762	1/2	12.7	1/2	1.25	31.8	0.91	23.0	2.24	57.0	3.46	88.0	NS	Y
S4-FH45-0812	28310-0812	20241761	1/2	12.7	3/4	1.63	41.3	1.20	30.5	3.15	80.0	4.37	111.0	NS	Y
S4-FH45-1212	28310-1212	20241790	3/4	19.0	3/4	1.63	41.3	1.22	31.0	3.31	84.0	4.88	124.0	NS	Y
S4-FH45-1216	28310-1216	20241794	3/4	19.0	1	1.87	47.6	1.32	33.5	3.15	80.0	4.72	120.0	NS	Y
S4-FH45-1616	28310-1616	20241774	1	25.4	1	1.87	47.6	1.42	36.0	3.82	97.0	5.55	141.0	NS	Y
S4-FH45-1620	28310-1620	20241778	1	25.4	1¼	2.13	54.0	1.54	39.0	3.78	96.0	5.55	141.0	NS	Y
S4-FH45-2020	28310-2020	20241764	1¼	31.8	1¼	2.13	54.0	1.57	40.0	4.29	109.0	6.34	161.0	NS	Y
S4-FH45-2024	28310-2024	20241765	1¼	31.8	1½	2.50	63.5	1.79	45.5	4.53	115.0	6.57	167.0	NS	Y
S4-FH45-2424	28310-2424	20241769	1½	38.1	1½	2.50	63.5	1.77	45.0	4.84	123.0	7.17	182.0	NS	Y
S4-FH45-2432	28310-2432	20241776	1½	38.1	2	3.13	79.4	2.26	57.5	5.24	133.0	7.56	192.0	NS	Y
S4-FH45-3232	28310-3232	20241767	2	50.8	2	3.13	79.4	2.36	60.0	6.18	157.0	9.02	229.0	NS	Y

Continued on next page

## Code 62 Flange (SAE J518)

45° Elbow Continued

Descriptive #	Product #	SAP #	Hose Size ID		Flange Size	Flange Diameter (A)		Drop (D)		Cut-Off (C)		Length (L)		Skive Type	SR12, ARC12
			in.	mm		in.	mm	in.	mm	in.	mm	in.	mm		
SG-FH45-0808	29310-0808	20822120	1/2	12.7	1/2	1.25	31.8	0.86	21.8	2.24	56.9	3.78	95.9	NS	Y
SG-FH45-0812	29310-0812	20822119	1/2	12.7	3/4	1.63	41.3	1.08	27.5	2.99	75.8	4.52	114.8	NS	Y
SG-FH45-1212	29310-1212	20822118	3/4	19.0	3/4	1.63	41.3	1.12	28.5	2.99	75.8	4.86	123.3	NS	Y
SG-FH45-1216	29310-1216	20822117	3/4	19.0	1	1.87	47.6	1.26	32.0	3.07	78.0	4.94	125.5	NS	Y
SG-FH45-1616	29310-1616	20822116	1	25.4	1	1.87	47.6	1.26	32.0	3.84	97.6	6.13	155.6	NS	Y
SG-FH45-1620	29310-1620	20822115	1	25.4	1 1/4	2.13	54.0	1.50	38.0	3.78	96.0	6.06	154.0	NS	Y

## Code 62 Flange (SAE J518)

60° Elbow

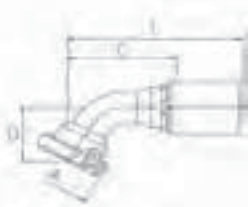

S=Skive  
NS=Non-Skive  
DG=Dual-Grip™

Descriptive #	Product #	SAP #	Hose Size ID		Flange Size	Flange Diameter (A)		Drop (D)		Cut-Off (C)		Length (L)		Skive Type	SR12, ARC12
			in.	mm		in.	mm	in.	mm	in.	mm	in.	mm		
S4-FH60-1212	28312-1212	20293299	3/4	19.0	3/4	1.63	41.3	1.61	41.0	3.56	90.5	5.12	130.0	NS	Y
S4-FH60-1616	28312-1616	20293300	1	25.4	1	1.87	47.6	1.99	50.5	4.21	107.0	5.96	151.5	NS	Y
S4-FH60-2020	28312-2020	20293301	1 1/4	31.8	1 1/4	2.13	54.0	2.32	59.0	5.26	133.5	7.30	185.5	NS	Y
S4-FH60-2024	28312-2024	20293302	1 1/4	31.8	1 1/2	2.50	63.5	2.48	63.0	5.49	139.5	7.54	191.5	NS	Y

Descriptive #	Product #	SAP #	Hose Size ID		Flange Size	Flange Diameter (A)		Drop (D)		Cut-Off (C)		Length (L)		Skive Type	SR12, ARC12
			in.	mm		in.	mm	in.	mm	in.	mm	in.	mm		
SG-FH60-1212	29312-1212	20822114	3/4	19.0	3/4	1.63	41.3	1.55	39.4	3.47	88.0	5.34	135.5	NS	Y
SG-FH60-1616	29312-1616	20822113	1	25.4	1	1.87	47.6	1.73	44.0	4.15	105.4	6.43	163.4	NS	Y

## Code 62 Flange (SAE J518)

67° Elbow

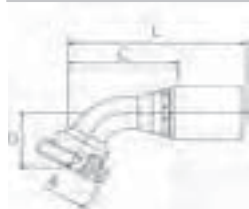

S=Skive  
NS=Non-Skive  
DG=Dual-Grip™

Descriptive #	Product #	SAP #	Hose Size ID		Flange Size	Flange Diameter (A)		Drop (D)		Cut-Off (C)		Length (L)		Skive Type	SR12, ARC12
			in.	mm		in.	mm	in.	mm	in.	mm	in.	mm		
S4-FH67-1616	28313-1616	20293304	1	25.4	1	1.87	47.6	2.24	57.0	3.94	100.0	5.68	144.2	NS	Y

Continued on next page

## Code 62 Flange (SAE J518)

67° Elbow Continued

Descriptive #	Product #	SAP #	Hose Size ID		Flange Size	Flange Diameter (A)		Drop (D)		Cut-Off (C)		Length (L)		Skive Type	SR12, ARC12
			in.	mm		in.	mm	in.	mm	in.	mm	in.	mm		
SG-FH67-1616	29313-1616	20822112	1	25.4	1	1.87	47.6	2.40	61.0	3.84	97.6	6.13	155.6	NS	Y

## Code 62 Flange (SAE J518)

90° Elbow

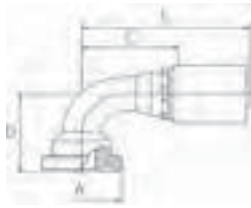

S=Skive  
NS=Non-Skive  
DG=Dual-Grip™

Descriptive #	Product #	SAP #	Hose Size ID		Flange Size	Flange Diameter (A)		Drop (D)		Cut-Off (C)		Length (L)		Skive Type	SR12, ARC12
			in.	mm		in.	mm	in.	mm	in.	mm	in.	mm		
S4-FH90-0808	28315-0808	20241739	1/2	12.7	1/2	1.25	31.8	1.81	46.0	1.89	48.0	3.11	79.0	NS	Y
S4-FH90-0812	28315-0812	20241737	1/2	12.7	3/4	1.63	41.3	2.13	54.0	1.89	48.0	3.11	79.0	NS	Y
S4-FH90-1012	28315-1012	20242953	5/8	15.9	3/4	1.63	41.3	2.17	55.0	1.97	50.0	3.31	84.0	NS	Y
S4-FH90-1212	28315-1212	20241731	3/4	19.0	3/4	1.63	41.3	2.40	61.0	2.48	63.0	4.06	103.0	NS	Y
S4-FH90-1216	28315-1216	20241734	3/4	19.0	1	1.87	47.6	2.60	66.0	2.48	63.0	4.06	103.0	NS	Y
S4-FH90-1612	28315-1612	20293303	1	25.4	3/4	1.63	41.3	2.40	61.0	2.87	73.0	4.61	117.0	NS	Y
S4-FH90-1616	28315-1616	20241787	1	25.4	1	1.87	47.6	2.95	75.0	2.91	74.0	4.65	118.0	NS	Y
S4-FH90-1620	28315-1620	20241743	1	25.4	1 1/4	2.13	54.0	3.07	78.0	3.07	78.0	4.80	122.0	NS	Y
S4-FH90-2016	28315-2016	20441315	1 1/4	31.8	1	1.87	47.6	2.83	72.0	3.35	85.0	5.39	137.0	NS	Y
S4-FH90-2020	28315-2020	20241780	1 1/4	31.8	1 1/4	2.13	54.0	3.50	89.0	3.70	94.0	5.75	146.0	NS	Y
S4-FH90-2024	28315-2024	20241781	1 1/4	31.8	1 1/2	2.50	63.5	3.70	94.0	3.86	98.0	5.91	150.0	NS	Y
S4-FH90-2424	28315-2424	20241771	1 1/2	38.1	1 1/2	2.50	63.5	4.13	105.0	3.94	100.0	6.26	159.0	NS	Y
S4-FH90-2432	28315-2432	20241777	1 1/2	38.1	2	3.13	79.4	4.84	123.0	4.53	115.0	6.85	174.0	NS	Y
S4-FH90-3232	28315-3232	20241740	2	50.8	2	3.13	79.4	5.20	132.0	5.63	143.0	8.46	215.0	NS	Y

Descriptive #	Product #	SAP #	Hose Size ID		Flange Size	Flange Diameter (A)		Drop (D)		Cut-Off (C)		Length (L)		Skive Type	SR12, ARC12
			in.	mm		in.	mm	in.	mm	in.	mm	in.	mm		
SG-FH90-0808	29315-0808	20731761	1/2	12.7	1/2	1.25	31.8	1.67	42.4	1.89	48.0	3.43	87.0	NS	Y
SG-FH90-080-0808	29317A-0808	20833294	1/2	12.7	1/2	1.25	31.8	3.15	80.0	1.99	50.5	3.53	89.7	NS	Y
SG-FH90-0812	29315-0812	20822111	1/2	12.7	3/4	1.63	41.3	2.28	58.0	1.89	48.0	3.43	87.0	NS	Y
SG-FH90-1012	29315-1012	20822110	5/8	15.9	3/4	1.63	41.3	2.28	58.0	1.97	50.0	3.56	90.5	NS	Y
SG-FH90-1212	29315-1212	20822109	3/4	19.0	3/4	1.63	41.3	2.28	58.0	2.36	59.8	4.23	107.3	NS	Y
SG-FH90-100-1212	29317A-1212	20833293	3/4	19.0	3/4	1.63	41.3	3.94	100.1	2.40	61.0	4.27	108.5	NS	Y
SG-FH90-122-1212	29317B-1212	20833292	3/4	19.0	3/4	1.63	41.3	4.80	121.9	2.80	71.1	4.67	118.6	NS	Y
SG-FH90-1216	29315-1216	20822108	3/4	19.0	1	1.87	47.6	2.76	70.0	2.60	66.0	4.47	113.5	NS	Y
SG-FH90-140-1216	29317A-1216	20833291	3/4	19.0	1	1.87	47.6	5.51	140.0	2.56	65.0	4.43	112.5	NS	Y

Continued on next page

## Code 62 Flange (SAE J518)

90° Elbow Continued

Descriptive #	Product #	SAP #	Hose Size ID		Flange Size	Flange Diameter (A)		Drop (D)		Cut-Off (C)		Length (L)		Skive Type	SR12, ARC12
			in.	mm		in.	mm	in.	mm	in.	mm	in.	mm		
SG-FH90-1612	29315-1612	20822107	1	25.4	3/4	1.63	41.3	2.28	58.0	2.87	72.9	5.15	130.9	NS	Y
SG-FH90-1616	29315-1616	20822106	1	25.4	1	1.87	47.6	2.76	70.1	2.97	75.4	5.25	133.4	NS	Y
SG-FH90-090-1616	29317A-1616	20833290	1	25.4	1	1.87	47.6	3.54	89.9	3.28	83.3	5.56	141.2	NS	Y
SG-FH90-120-1616	29317B-1616	20833229	1	25.4	1	1.87	47.6	4.72	119.9	3.04	77.2	5.32	135.1	NS	Y
SG-FH90-1620	29315-1620	20822105	1	25.4	1¼	2.13	54.0	3.54	90.0	3.07	78.0	5.35	136.0	NS	Y

## Caterpillar® Flange

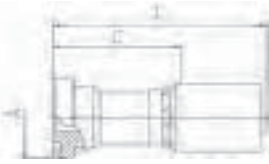

S=Skive  
 NS=Non-Skive  
 DG=Dual-Grip™

Descriptive #	Product #	SAP #	Hose Size ID		Flange Size	Flange Diameter (A)		Cut-Off (C)		Length (L)		Skive Type	SR12, ARC12
			in.	mm		in.	mm	in.	mm	in.	mm		
S4-CF-1212	28185-1212	20293305	3/4	19.0	3/4	1.63	41.3	3.46	88.0	5.02	127.5	NS	Y
S4-CF-1216	28185-1216	20441277	3/4	19.0	1	1.87	47.6	3.52	89.5	5.08	129.0	NS	Y
S4-CF-1612	28185-1612	20441322	1	25.4	3/4	1.63	41.3	3.48	88.4	5.24	133.0	NS	Y
S4-CF-1616	28185-1616	20293306	1	25.4	1	1.87	47.6	3.54	90.0	5.30	134.6	NS	Y
S4-CF-1620	28185-1620	20441278	1	25.4	1¼	2.13	54.0	3.66	93.0	5.42	137.6	NS	Y
S4-CF-2020	28185-2020	20441206	1¼	31.8	1¼	2.13	54.0	3.43	87.0	5.47	139.0	NS	Y
S4-CF-2024	28185-2024	20441279	1¼	31.8	1½	2.50	63.5	3.58	91.0	5.63	143.0	NS	Y
S4-CF-2424	28185-2424	20293307	1½	38.1	1½	2.50	63.5	3.31	84.0	5.63	143.0	NS	Y
S4-CF-2432	28185-2432	20441323	1½	38.1	2	3.13	79.4	3.86	98.0	6.18	157.0	NS	Y
S4-CF-3232	28185-3232	20293308	2	50.8	2	3.13	79.4	4.33	110.0	7.17	182.0	NS	Y

Descriptive #	Product #	SAP #	Hose Size ID		Flange Size	Flange Diameter (A)		Cut-Off (C)		Length (L)		Skive Type	SR12, ARC12
			in.	mm		in.	mm	in.	mm	in.	mm		
SG-CF-1212	29185-1212	20822200	3/4	19.0	3/4	1.63	41.3	3.38	85.8	5.25	133.2	NS	Y
SG-CF-1216	29185-1216	20822199	3/4	19.0	1	1.87	47.6	3.50	88.9	5.37	136.4	NS	Y
SG-CF-1612	29185-1612	20822198	1	25.4	3/4	1.63	41.3	3.47	88.0	5.75	146.0	NS	Y
SG-CF-1616	29185-1616	20822197	1	25.4	1	1.87	47.6	3.69	93.8	6.00	152.3	NS	Y
SG-CF-1620	29185-1620	20822196	1	25.4	1¼	2.13	54.0	3.62	92.0	5.91	150.0	NS	Y



# Caterpillar® Flange

22.5° Elbow



S=Skive  
NS=Non-Skive  
DG=Dual-Grip™

Descriptive #	Product #	SAP #	Hose Size ID		Flange Size	Flange Diameter (A)		Drop (D)		Cut-Off (C)		Length (L)		Skive Type	SR12, ARC12
			in.	mm		in.	mm	in.	mm	in.	mm	in.	mm		
S4-CF22-1212	28187-1212	20441272	3/4	19.0	3/4	1.63	41.3	0.63	16.0	3.78	96.0	5.35	136.0	NS	Y
S4-CF22-1616	28187-1616	20441280	1	25.4	1	1.87	47.6	0.71	18.0	4.33	110.0	6.10	155.0	NS	Y
S4-CF22-1620	28187-1620	20441306	1	25.4	1¼	2.13	54.0	0.71	18.0	4.29	109.0	6.06	154.0	NS	Y
S4-CF22-2020	28187-2020	20441307	1¼	31.8	1¼	2.13	54.0	0.77	19.5	4.80	122.0	6.85	174.0	NS	Y
S4-CF22-2024	28187-2024	20441281	1¼	31.8	1½	2.50	63.5	0.91	23.0	5.12	130.0	7.17	182.0	NS	Y

Descriptive #	Product #	SAP #	Hose Size ID		Flange Size	Flange Diameter (A)		Drop (D)		Cut-Off (C)		Length (L)		Skive Type	SR12, ARC12
			in.	mm		in.	mm	in.	mm	in.	mm				
SG-CF22-1212	29187-1212	20822195	3/4	19.0	3/4	1.63	41.3	0.63	16.0	3.25	82.6	5.20	132.0	NS	Y
SG-CF22-1616	29187-1616	20822194	1	25.4	1	1.87	47.6	0.71	18.0	4.22	107.1	6.50	165.1	NS	Y
SG-CF22-1620	29187-1620	20822193	1	25.4	1¼	2.13	54.0	0.71	18.0	4.29	109.0	6.57	167.0	NS	Y

# Caterpillar® Flange

30° Elbow

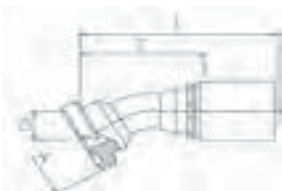

S=Skive  
NS=Non-Skive  
DG=Dual-Grip™

Descriptive #	Product #	SAP #	Hose Size ID		Flange Size	Flange Diameter (A)		Drop (D)		Cut-Off (C)		Length (L)		Skive Type	SR12, ARC12
			in.	mm		in.	mm	in.	mm	in.	mm				
S4-CF30-1216	28188-1216	20441324	3/4	19.0	1	1.87	47.6	0.87	22.0	3.82	97.0	5.39	137.0	NS	Y

Descriptive #	Product #	SAP #	Hose Size ID		Flange Size	Flange Diameter (A)		Drop (D)		Cut-Off (C)		Length (L)		Skive Type	SR12, ARC12
			in.	mm		in.	mm	in.	mm	in.	mm				
SG-CF30-1216	29188-1216	20822192	3/4	19.0	1	1.87	47.6	0.88	22.2	3.82	97.0	5.69	144.5	NS	Y

## Caterpillar® Flange

45° Elbow

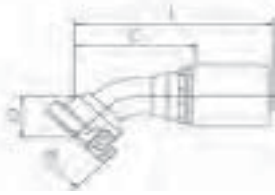

S=Skive  
NS=Non-Skive  
DG=Dual-Grip™

Descriptive #	Product #	SAP #	Hose Size ID		Flange Size	Flange Diameter (A)		Drop (D)		Cut-Off (C)		Length (L)		Skive Type	SR12, ARC12
			in.	mm		in.	mm	in.	mm	in.	mm	in.	mm		
S4-CF45-1212	28190-1212	20441282	3/4	19.0	3/4	1.63	41.3	1.34	34.0	3.39	86.0	4.96	126.0	NS	Y
S4-CF45-1216	28190-1216	20441308	3/4	19.0	1	1.87	47.6	1.34	34.0	3.54	90.0	5.08	129.0	NS	Y
S4-CF45-1616	28190-1616	20441283	1	25.4	1	1.87	47.6	1.57	40.0	3.90	99.0	5.63	143.0	NS	Y
S4-CF45-1620	28190-1620	20441284	1	25.4	1¼	2.13	54.0	1.57	40.0	3.86	98.0	5.59	142.0	NS	Y
S4-CF45-2020	28190-2020	20441285	1¼	31.8	1¼	2.13	54.0	1.69	43.0	4.33	110.0	6.38	162.0	NS	Y
S4-CF45-2024	28190-2024	20441286	1¼	31.8	1½	2.50	63.5	1.95	49.5	4.57	116.0	6.61	168.0	NS	Y
S4-CF45-2424	28190-2424	20441325	1½	38.1	1½	2.50	63.5	1.89	48.0	7.01	178.0	9.33	237.0	NS	Y

Descriptive #	Product #	SAP #	Hose Size ID		Flange Size	Flange Diameter (A)		Drop (D)		Cut-Off (C)		Length (L)		Skive Type	SR12, ARC12
			in.	mm		in.	mm	in.	mm	in.	mm	in.	mm		
SG-CF45-1212	29190-1212	20822191	3/4	19.0	3/4	1.63	41.3	1.34	34.0	2.99	75.8	4.86	123.3	NS	Y
SG-CF45-1216	29190-1216	20822190	3/4	19.0	1	1.87	47.6	1.34	34.0	3.50	88.9	5.37	136.4	NS	Y
SG-CF45-1616	29190-1616	20822189	1	25.4	1	1.87	47.6	1.57	39.9	3.84	97.6	6.13	155.6	NS	Y
SG-CF45-1620	29190-1620	20822188	1	25.4	1¼	2.13	54.0	1.50	38.0	3.86	98.0	6.14	156.0	NS	Y

## Caterpillar® Flange

60° Elbow

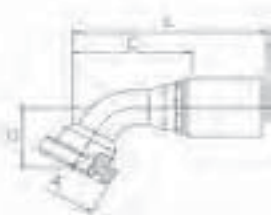

S=Skive  
NS=Non-Skive  
DG=Dual-Grip™

Descriptive #	Product #	SAP #	Hose Size ID		Flange Size	Flange Diameter (A)		Drop (D)		Cut-Off (C)		Length (L)		Skive Type	SR12, ARC12
			in.	mm		in.	mm	in.	mm	in.	mm				
S4-CF60-1616	28192-1616	20441287	1	25.4	1	1.87	47.6	2.09	53.0	4.61	117.0	6.34	161.0	NS	Y
S4-CF60-1620	28192-1620	20441288	1	25.4	1¼	2.13	54.0	2.24	57.0	4.45	113.0	6.18	157.0	NS	Y
S4-CF60-2020	28192-2020	20441289	1¼	31.8	1¼	2.13	54.0	2.52	64.0	5.2	132.0	7.24	184.0	NS	Y
S4-CF60-2024	28192-2024	20441290	1¼	31.8	1½	2.50	63.5	2.76	70.0	5.35	136.0	7.40	188.0	NS	Y
S4-CF60-2432	28192-2432	20441326	1½	38.1	2	3.13	79.4	3.35	85.0	5.47	139.0	7.80	198.0	NS	Y

Continued on next page

# Caterpillar® Flange

## 60° Elbow Continued

Descriptive #	Product #	SAP #	Hose Size ID		Flange Size (A)	Flange Diameter (A)		Drop (D)		Cut-Off (C)		Length (L)		Skive Type	SR12, ARC12
			in.	mm		in.	mm	in.	mm	in.	mm	in.	mm		
SG-CF60-1616	29192-1616	20822187	1	25.4	1	1.88	47.6	2.09	53.1	4.15	105.4	6.43	163.4	NS	Y
SG-CF60-1620	29192-1620	20822186	1	25.4	1¼	2.13	54.0	2.17	55.0	4.45	113.0	6.73	171.0	NS	Y

# Caterpillar® Flange

## 67° Elbow

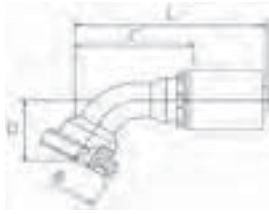

S=Skive  
NS=Non-Skive  
DG=Dual-Grip™

Descriptive #	Product #	SAP #	Hose Size ID		Flange Size	Flange Diameter (A)		Drop (D)		Cut-Off (C)		Length (L)		Skive Type	SR12, ARC12
			in.	mm		in.	mm	in.	mm	in.	mm				
S4-CF67-2020	28194-2020	20441327	1¼	31.8	1¼	2.13	54.0	2.76	70.0	4.92	125.0	6.97	177.0	NS	Y
S4-CF67-2024	28194-2024	20441328	1¼	31.8	1½	2.50	63.5	3.07	78.0	5.04	128.0	7.09	180.0	NS	Y

# Caterpillar® Flange

## 90° Elbow

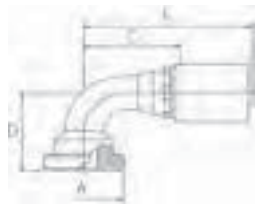

S=Skive  
NS=Non-Skive  
DG=Dual-Grip™

Descriptive #	Product #	SAP #	Hose Size ID		Flange Size	Flange Diameter (A)		Drop (D)		Cut-Off (C)		Length (L)		Skive Type	SR12, ARC12
			in.	mm		in.	mm	in.	mm	in.	mm				
S4-CF90-1212	28195-1212	20293309	3/4	19.0	3/4	1.63	41.3	2.64	67.0	2.60	66.0	4.17	106.0	NS	Y
S4-CF90-1216	28195-1216	20441291	3/4	19.0	1	1.87	47.6	2.76	70.0	2.68	68.0	4.21	107.0	NS	Y
S4-CF90-1616	28195-1616	20293310	1	25.4	1	1.87	47.6	3.11	79.0	3.27	83.0	5.00	127.0	NS	Y
S4-CF90-1620	28195-1620	20441273	1	25.4	1¼	2.13	54.0	3.25	82.5	3.07	78.0	4.80	122.0	NS	Y
S4-CF90-2020	28195-2020	20441274	1¼	31.8	1¼	2.13	54.0	3.66	93.0	3.62	92.0	5.67	144.0	NS	Y
S4-CF90-2024	28195-2024	20441275	1¼	31.8	1½	2.50	63.5	3.98	101.0	3.70	94.0	5.75	146.0	NS	Y
S4-CF90-2424	28195-2424	20441332	1½	38.1	1½	2.50	63.5	4.29	109.0	4.41	112.0	6.73	171.0	NS	Y

Continued on next page

## Caterpillar® Flange

90° Elbow Continued

Descriptive #	Product #	SAP #	Hose Size ID		Flange Size	Flange Diameter (A)		Drop (D)		Cut-Off (C)		Length (L)		Skive Type	SR12, ARC12
			in.	mm		in.	mm	in.	mm	in.	mm	in.	mm		
SG-CF90-1212	29195-1212	20822185	3/4	19.0	3/4	1.63	41.3	2.60	66.0	2.36	59.8	4.23	107.3	NS	Y
SG-CF90-1216	29195-1216	20822184	3/4	19.0	1	1.87	47.6	2.76	70.1	2.65	67.3	4.52	114.8	NS	Y
SG-CF90-1616	29195-1616	20822183	1	25.4	1	1.87	47.6	3.11	79.0	2.97	75.4	5.25	133.4	NS	Y
SG-CF90L-1616	29195-1616L	20822181	1	25.4	1	1.87	47.6	5.20	132.1	3.35	85.1	5.63	143.1	NS	Y
SG-CF90-1620	29195-1620	20822182	1	25.4	1¼	2.13	54.0	3.54	90.0	3.07	78.0	5.35	136.0	NS	Y

## Komatsu® Flange



S=Skive  
NS=Non-Skive  
DG=Dual-Grip™

Descriptive #	Product #	SAP #	Hose Size ID		Flange Size	Flange Diameter (A)		Cut-Off (C)		Length (L)		Skive Type	SR12, ARC12
			in.	mm		in.	mm	in.	mm	in.	mm		
S4-KF-0810	28530-0810	20441211	1/2	12.7	5/8	1.34	34.0	1.84	46.7	3.08	78.2	NS	Y
S4-KF-1010	28530-1010	20441212	5/8	15.9	5/8	1.34	34.0	1.84	46.7	3.19	81.0	NS	Y
S4-KF-1210	28530-1210	20441295	3/4	19.0	5/8	1.34	34.0	1.99	50.5	3.54	90.0	NS	Y

Descriptive #	Product #	SAP #	Hose Size ID		Flange Size	Flange Diameter (A)		Cut-Off (C)		Length (L)		Skive Type	SR12, ARC12
			in.	mm		in.	mm	in.	mm	in.	mm		
SG-KF-0810	29530-0810	20821988	1/2	12.7	5/8	1.34	34.0	1.83	46.6	3.39	86.1	NS	Y
SG-KF-1010	29530-1010	20821987	5/8	15.9	5/8	1.34	34.0	1.84	46.8	3.44	87.3	NS	Y
SG-KF-1210	29530-1210	20821986	3/4	19.0	5/8	1.34	34.0	1.99	50.5	3.86	98.0	NS	Y

## Komatsu® Flange

45° Elbow

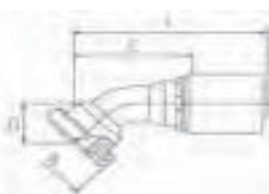

S=Skive  
NS=Non-Skive  
DG=Dual-Grip™

Descriptive #	Product #	SAP #	Hose Size ID		Flange Size	Flange Diameter (A)		Drop (D)		Cut-Off (C)		Length (L)		Skive Type	SR12, ARC12
			in.	mm		in.	mm	in.	mm	in.	mm				
S4-KF45-1010	28535-1010	20441204	5/8	15.9	5/8	1.34	34.0	0.98	25.0	2.32	59.0	3.66	93.0	NS	Y

Continued on next page

# Komatsu® Flange

## 45° Elbow Continued

Descriptive #	Product #	SAP #	Hose Size ID		Flange Size	Flange Diameter (A)		Drop (D)		Cut-Off (C)		Length (L)		Skive Type	SR12, ARC12
			in.	mm		in.	mm	in.	mm	in.	mm	in.	mm		
SG-KF45-1010	29535-1010	20821985	5/8	15.9	5/8	1.34	34.0	0.98	24.9	2.32	58.9	3.91	99.4	NS	Y

# Komatsu® Flange

## 90° Elbow

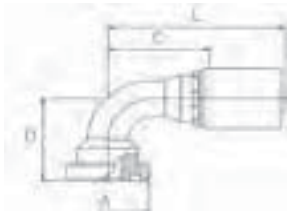

S=Skive  
NS=Non-Skive  
DG=Dual-Grip™

Descriptive #	Product #	SAP #	Hose Size ID		Flange Size	Flange Diameter (A)		Drop (D)		Cut-Off (C)		Length (L)		Skive Type	SR12, ARC12
			in.	mm		in.	mm	in.	mm	in.	mm	in.	mm		
S4-KF90-1010	28540-1010	20441205	5/8	15.9	5/8	1.34	34.0	2.01	51.0	1.97	50.0	3.35	85.0	NS	Y
S4-KF90-1210	28540-1210	20441296	3/4	19.0	5/8	1.34	34.0	2.01	51.0	2.17	55.0	3.74	95.0	NS	Y

Descriptive #	Product #	SAP #	Hose Size ID		Flange Size	Flange Diameter (A)		Drop (D)		Cut-Off (C)		Length (L)		Skive Type	SR12, ARC12
			in.	mm		in.	mm	in.	mm	in.	mm	in.	mm		
SG-KF90-1010	29540-1010	20821984	5/8	15.9	5/8	1.34	34.0	2.01	51.1	1.97	50.0	3.56	90.5	NS	Y
SG-KF90-1210	29540-1210	20821983	3/4	19.0	5/8	1.34	34.0	2.01	51.1	2.17	55.1	4.04	102.6	NS	Y

# BSP (British Standard Pipe Parallel)

## Female | Swivel

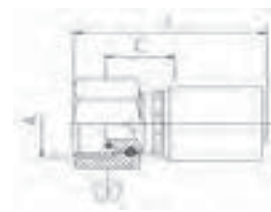

S=Skive  
NS=Non-Skive  
DG=Dual-Grip™

Descriptive #	Product #	SAP #	Hose Size ID		Thread Size (A)	Hex-1 Wrench Size		Cut-Off (C)		Length (L)		Skive Type	SR12, ARC12
			in.	mm		in.	mm	in.	mm	in.	mm		
S4-BPFX-0606 <sup>S</sup>	28105-0606	20242857	3/8	9.5	3/8-19	7/8	22	0.92	23.3	2.19	55.5	NS	Y
S4-BPFX-0808 <sup>S</sup>	28105-0808	20242825	1/2	12.7	1/2-14	1 1/16	27	0.99	25.1	2.46	62.5	NS	Y
S4-BPFX-1212 <sup>C</sup>	28105-1212	20242817	3/4	19.0	3/4-14	1 1/4	32	0.81	20.6	2.72	69.1	NS	Y
S4-BPFX-1616 <sup>C</sup>	28105-1616	20242861	1	25.4	1-11	1 1/2	38	0.94	23.9	3.11	79.0	NS	Y
S4-BPFX-2020	28105-2020	20242842	1 1/4	31.8	1 1/4-11	2	50	1.26	32.0	3.70	94.0	NS	Y

C: Crimp Nut S: Slip Nut (see "Fitting Identification" in Appendix for details)

Continued on next page

## BSPF (British Standard Pipe Parallel)

Female | Swivel Continued

Descriptive #	Product #	SAP #	Hose Size ID		Thread Size (A)	Hex-1 Wrench Size		Cut-Off (C)		Length (L)		Skive Type	SR12, ARC12
			in.	mm	in.	mm	in.	mm	in.	mm			
S4-BPFX-2424	28105-2424	20242860	1½	38.1	1½-11	2¾/16	55	1.33	33.8	4.13	105.0	NS	Y
S4-BPFX-3232	28105-3232	20242819	2	50.8	2-11	2¾	70	1.34	34.0	4.80	122.0	NS	Y

Descriptive #	Product #	SAP #	Hose Size ID		Thread Size (A)	Hex-1 Wrench Size		Cut-Off (C)		Length (L)		Skive Type	SR12, ARC12
			in.	mm	in.	mm	in.	mm	in.	mm			
SG-BPFX-0608	29105-0608	20822223	3/8	9.5	1/2-14	1¼/16	27	1.04	26.3	2.49	63.3	NS	Y
SG-BPFX-0808	29105-0608	20731754	1/2	12.7	1/2-14	1¼/16	27	1.22	31.0	2.54	64.4	NS	Y
SG-BPFX-0810	29105-0810	20822222	1/2	12.7	5/8-14	1¼/16	27	1.15	29.2	2.38	60.5	NS	Y
SG-BPFX-1212T	29105-1212	20822221	3/4	19.0	3/4-14	1¼	32	1.39	35.2	3.26	82.7	NS	Y
SG-BPFX-1616T	29105-1616	20822220	1	25.4	1-11	1½	38	1.63	41.4	3.91	99.3	NS	Y

T: Thrust-Wire Nut (see "Fitting Identification" in Appendix for details)

## BSPF (British Standard Pipe Parallel)

Female | 45° Elbow | Swivel

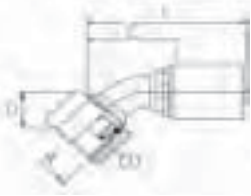

S=Skive  
NS=Non-Skive  
DG=Dual-Grip™

Descriptive #	Product #	SAP #	Hose Size ID		Thread Size (A)	Hex-1 Wrench Size		Drop (D)		Cut-Off (C)		Length (L)		Skive Type	SR12, ARC12
			in.	mm	in.	mm	in.	mm	in.	mm	in.	mm			
S4-BPFX45-0808 <sup>S</sup>	28115-0808	20242852	1/2	12.7	1/2-14	1¼/16	27	0.83	21.0	2.17	55.0	3.43	87.0	NS	Y
S4-BPFX45-1212 <sup>C</sup>	28115-1212	20242858	3/4	19.0	3/4-14	1¼	32	1.10	28.0	2.76	70.0	4.33	110.0	NS	Y
S4-BPFX45-1616 <sup>C</sup>	28115-1616	20242856	1	25.4	1-11	1½	38	1.34	34.0	3.31	84.0	5.04	128.0	NS	Y
S4-BPFX45-2020	28115-2020	20242854	1¼	31.8	1¼-11	2	50	1.57	40.0	3.98	101.0	6.22	158.0	NS	Y
S4-BPFX45-2424	28115-2424	20242855	1½	38.1	1½-11	2¾/16	55	1.81	46.0	4.57	116.0	7.13	181.0	NS	Y
S4-BPFX45-3232	28115-3232	20242841	2	50.8	2-11	2¾	70	2.36	60.0	5.98	152.0	9.13	232.0	NS	Y

C: Crimp Nut S: Slip Nut (see "Fitting Identification" in Appendix for details)

Descriptive #	Product #	SAP #	Hose Size ID		Thread Size (A)	Hex-1 Wrench Size		Drop (D)		Cut-Off (C)		Length (L)		Skive Type	SR12, ARC12
			in.	mm	in.	mm	in.	mm	in.	mm	in.	mm			
SG-BPFX45-0808	29115-0808	20822218	1/2	12.7	1/2-14	1¼/16	27	0.83	21.1	2.17	55.1	3.71	94.1	NS	Y
SG-BPFX45-1212T	29115-1212	20822217	3/4	19.0	3/4-14	1¼	32	1.08	27.4	2.79	70.8	4.91	124.8	NS	Y
SG-BPFX45-1616T	29115-1616	20822216	1	25.4	1-11	1½	38	1.34	34.0	3.31	84.1	5.59	142.1	NS	Y

T: Thrust-Wire Nut (see "Fitting Identification" in Appendix for details)

# BSPB (British Standard Pipe Parallel)

Female | 90° Elbow | Swivel

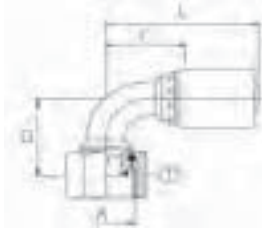

S=Skive  
NS=Non-Skive  
DG=Dual-Grip™

Descriptive #	Product #	SAP #	Hose Size ID		Thread Size (A)	Hex-1 Wrench Size		Drop (D)		Cut-Off (C)		Length (L)		Skive Type	SR12, ARC12
			in.	mm	in.	mm	in.	mm	in.	mm	in.	mm			
S4-BPFX90-0808 <sup>S</sup>	28120-0808	20242869	1/2	12.7	1/2-14	1 1/16	27	1.61	41.0	1.42	36.0	2.64	67.0	NS	Y
S4-BPFX90-1212 <sup>C</sup>	28120-1212	20242865	3/4	19.0	3/4-14	1 1/4	32	2.09	53.0	1.93	49.0	3.50	89.0	NS	Y
S4-BPFX90-1616 <sup>C</sup>	28120-1616	20242844	1	25.4	1-11	1 1/2	38	2.72	69.0	2.95	75.0	4.72	120.0	NS	Y
S4-BPFX90-2020	28120-2020	20242848	1 1/4	31.8	1 1/4-11	2	50	3.27	83.0	3.23	82.0	5.28	134.0	NS	Y
S4-BPFX90-2424	28120-2424	20242843	1 1/2	38.1	1 1/2-11	2 3/16	55	3.78	96.0	3.78	96.0	6.10	155.0	NS	Y
S4-BPFX90-3232	28120-3232	20242867	2	50.8	2-11	2 3/4	70	5.35	136.0	5.04	128.0	7.87	200.0	NS	Y

C: Crimp Nut S: Slip Nut (see "Fitting Identification" in Appendix for details)

Descriptive #	Product #	SAP #	Hose Size ID		Thread Size (A)	Hex-1 Wrench Size		Drop (D)		Cut-Off (C)		Length (L)		Skive Type	SR12, ARC12
			in.	mm	in.	mm	in.	mm	in.	mm	in.	mm			
SG-BPFX90-0608	29120-0608	20822214	3/8	9.5	1/2-14	1 1/16	27	1.40	35.6	1.3	34.0	2.8	71.0	NS	Y
SG-BPFX90-0808	29120-0808	20731763	1/2	12.7	1/2-14	1 1/16	27	1.6	40.9	1.4	36.1	3.0	75.1	NS	Y
SG-BPFX90-1212 <sup>T</sup>	29120-1212	20822213	3/4	19.0	3/4-14	1 1/4	32	2.2	56.9	2.3	59.7	4.2	107.2	NS	Y
SG-BPFX90-1616 <sup>T</sup>	29120-1616	20822212	1	25.4	1-11	1 1/2	38	2.8	71.1	3.0	77.3	5.3	135.3	NS	Y

T: Thrust-Wire Nut (see "Fitting Identification" in Appendix for details)

# BSPB (British Standard Pipe Parallel)

Male

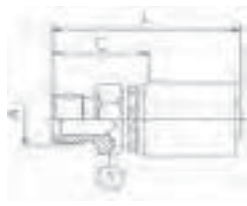

S=Skive  
NS=Non-Skive  
DG=Dual-Grip™

Descriptive #	Product #	SAP #	Hose Size ID		Thread Size (A)	Hex-1 Wrench Size		Cut-Off (C)		Length (L)		Skive Type	SR12, ARC12
			in.	mm	in.	mm	in.	mm	in.	mm			
S4-BPM-1212	28130-1212	20242831	3/4	19.0	3/4-14	1 1/4	32	1.44	36.6	3.00	76.1	NS	Y
S4-BPM-2020	28130-2020	20242836	1 1/4	31.8	1 1/4-11	2	50	1.89	48.0	3.94	100.0	NS	Y
S4-BPM-2424	28130-2424	20242837	1 1/2	38.1	1 1/2-11	2 3/16	55	2.01	51.0	4.33	110.0	NS	Y
S4-BPM-3232	28130-3232	20242833	2	50.8	2-11	2 3/4	70	2.22	56.5	5.06	128.5	NS	Y

Continued on next page

## BSPB (British Standard Pipe Parallel)

Male Continued

Descriptive #	Product #	SAP #	Hose Size ID		Thread Size (A)	Hex-1 Wrench Size		Cut-Off (C)		Length (L)		Skive Type	SR12, ARC12
			in.	mm		in.	mm	in.	mm	in.	mm		
SG-BPM-0606	29130-0606	20822211	3/8	9.5	3/8-19	7/8	22	1.20	30.5	2.66	67.5	NS	Y
SG-BPM-0608	29130-0608	20822210	3/8	9.5	1/2-14	1 1/16	27	1.34	34.0	2.80	71.0	NS	Y
SG-BPM-0806	29130-0806	20822209	1/2	12.7	3/8-19	7/8	22	1.20	30.5	2.74	69.5	NS	Y
SG-BPM-0808	29130-0808	20822208	1/2	12.7	1/2-14	1 1/16	27	1.34	34.0	2.88	73.1	NS	Y
SG-BPM-1212	29130-1212	20822207	3/4	19.0	3/4-14	1 1/4	32	1.56	39.6	3.43	87.1	NS	Y
SG-BPM-1616	29130-1616	20822206	1	25.4	1-11			1.86	47.1	4.14	105.1	NS	Y

## BSPT (British Standard Pipe Tapered)

Male

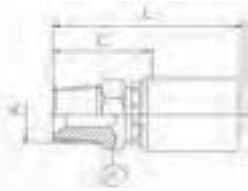

S=Skive  
NS=Non-Skive  
DG=Dual-Grip™

Descriptive #	Product #	SAP #	Hose Size ID		Thread Size (A)	Hex-1 Wrench Size		Cut-Off (C)		Length (L)		Skive Type	SR12, ARC12
			in.	mm		in.	mm	in.	mm	in.	mm		
S4-BTM-1616	28170-1616	20242875	1	25.4	1-11	1 7/16	36	1.75	44.4	3.50	89.0	NS	Y

Descriptive #	Product #	SAP #	Hose Size ID		Thread Size (A)	Hex-1 Wrench Size		Cut-Off (C)		Length (L)		Skive Type	SR12, ARC12
			in.	mm		in.	mm	in.	mm	in.	mm		
SG-BTM-0606	29170-0606	20822205	3/8	9.5	3/8-19			1.20	30.5	2.66	67.5	NS	Y
SG-BTM-0808	29170-0808	20822204	1/2	12.7	1/2-14			1.37	34.9	2.91	73.9	NS	Y
SG-BTM-1212	29170-1212	20822203	3/4	19.1	3/4-14			1.48	37.5	3.35	85.0	NS	Y
SG-BTM-1616	29170-1616	20822202	1	25.4	1-11	1 7/16	36	1.89	48.1	4.18	106.1	NS	Y

## BSP Flat Seat (British Standard Pipe)

Female | Swivel

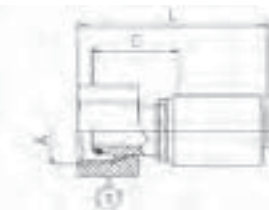

S=Skive  
NS=Non-Skive  
DG=Dual-Grip™

Descriptive #	Product #	SAP #	Hose Size ID		Thread Size (A)	Hex-1 Wrench Size		Cut-Off (C)		Length (L)		Skive Type	SR12, ARC12
			in.	mm		in.	mm	in.	mm	in.	mm		
SG-BFFX-0608	29100-0608	20822227	3/8	9.5	1/2-14			0.80	20.3	2.26	57.3	NS	
SG-BFFX-0808	29100-0808	20822226	1/2	12.7	1/2-14			0.82	20.9	2.36	59.8	NS	
SG-BFFX-0812	29100-0812	20822225	1/2	12.7	3/4-14			1.00	25.4	2.54	64.4	NS	



# DIN 24° Light

Female | Swivel

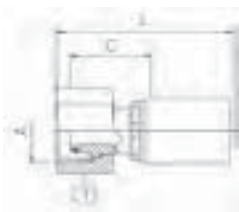

S=Skive  
NS=Non-Skive  
DG=Dual-Grip™

Descriptive #	Product #	SAP #	Hose Size ID		Thread Size (A)	Hex-1 Wrench Size	Cut-Off (C)		Length (L)		Skive Type	SR12, ARC12
			in.	mm			in.	mm	in.	mm		
S4-DLFX-0618	28240-0618	20441313	3/8	9.5	18x1.5	22	1.00	25.4	2.10	53.3	NS	Y
S4-DLFX-0822	28240-0822	20441207	1/2	12.7	22x1.5	27	1.11	28.2	2.43	61.8	NS	Y
S4-DLFX-1026	28240-1026	20441200	5/8	15.9	26x1.5	32	1.15	29.2	2.58	65.6	NS	Y
S4-DLFX-1230	28240-1230	20241841	3/4	19.0	30x2.0	36	1.25	31.7	2.93	74.5	NS	Y
S4-DLFX-1236	28240-1236	20441208	3/4	19.0	36x2.0	41	1.29	32.8	3.02	76.6	NS	Y
S4-DLFX-1636	28240-1636	20441209	1	25.4	36x2.0	41	1.32	33.6	3.25	82.5	NS	Y
S4-DLFX-2045	28240-2045	20241857	1¼	31.8	45x2.0	50	1.58	40.1	3.78	95.9	NS	Y
S4-DLFX-2452	28240-2452	20441314	1½	38.1	52x2.0	60	1.59	40.5	4.05	102.8	NS	Y

Descriptive #	Product #	SAP #	Hose Size ID		Thread Size (A)	Hex-1 Wrench Size	Cut-Off (C)		Length (L)		Skive Type	SR12, ARC12
			in.	mm			in.	mm	in.	mm		
SG-DLFX-0618	29240-0618	20758288	3/8	9.5	18x1.5						NS	Y
SG-DLFX-0822	29240-0822	20758302	1/2	12.7	22x1.5	27	1.21	30.7	2.46	62.4	NS	Y
SG-DLFX-1230	29240-1230	20822154	3/4	19.1	30x2.0	36	1.42	36.0	3.29	83.5	NS	Y
SG-DLFX-1236	29240-1236	20822153	3/4	19.0	36x2.0	41	1.60	40.7	3.47	88.2	NS	Y
SG-DLFX-1636	29240-1636	20822152	1	25.4	36x2.0	41	1.49	37.9	3.60	91.5162	NS	Y

# DIN 24° Light

Female | 45° Elbow | Swivel

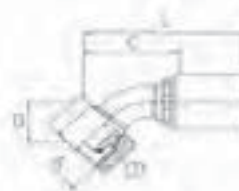

S=Skive  
NS=Non-Skive  
DG=Dual-Grip™

Descriptive #	Product #	SAP #	Hose Size ID		Thread Size (A)	Hex-1 Wrench Size	Drop (D)		Cut-Off (C)		Length (L)		Skive Type	SR12, ARC12
			in.	mm			in.	mm	in.	mm	in.	mm		
S4-DLFX45-2452	28245-2452	20588801	1½	38.1	52x2.0	60	1.85	47.0	4.49	114.0	6.82	173.1	NS	Y

Descriptive #	Product #	SAP #	Hose Size ID		Thread Size (A)	Hex-1 Wrench Size	Drop (D)	Length (L)		Skive Type	SR12, ARC12			
			in.	mm				in.	mm					
SG-DLFX45-0822	29245-0822	20822150	1/2	12.7	22x1.5	27	0.83	21.1	2.17	55.1	3.71	94.1	NS	Y
SG-DLFX45-1230	29245-1230	20822149	3/4	19.1	30x2.0	36	1.26	32.0	2.72	69.1	4.59	116.6	NS	Y
SG-DLFX45-1636	29245-1636	20822148	1	25.4	36x2.0	41	1.26	32.0	3.58	90.9	5.86	148.9	NS	Y

## DIN 24° Light

Female | 90° Elbow | Swivel

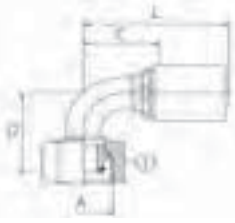

S=Skive  
NS=Non-Skive  
DG=Dual-Grip™

Descriptive #	Product #	SAP #	Hose Size ID		Thread Size (A)	Hex-1 Wrench Size	Drop (D)		Cut-Off (C)		Length (L)		Skive Type	SR12, ARC12
			in.	mm			mm	in.	mm	in.	mm	in.		
S4-DLFX90-0618	28250-0618	20813981	3/8	9.5	18x1.5	22	1.54	39.1	1.30	33.0	2.35	59.7	NS	Y
S4-DLFX90-0822	28250-0822	20813982	1/2	12.7	22x1.5	27	1.59	40.4	1.57	39.9	2.82	71.6	NS	Y
S4-DLFX90-1222	28250-1222	20477378	3/4	19.0	22x1.5	36	Dimensions not available at printing					NS	Y	
S4-DLFX90-1230	28250-1230	20441210	3/4	19.0	30x2.0	36	2.32	59.0	2.05	52.0	3.62	92.0	NS	Y
S4-DLFX90-1636	28250-1636	20441201	1	25.4	36x2.0	41	2.68	68.0	3.07	78.0	4.80	122.0	NS	Y
S4-DLFX90-2045	28250-2045	20241872	1¼	31.8	45x2.0	50	3.50	89.0	3.54	90.0	5.59	142.0	NS	Y
S4-DLFX90-2452	28250-2452	20588800	1½	38.1	52x2.0	60	3.84	97.49	4.21	107.0	6.54	166.1	NS	Y
S4-DLFX90XL-2452	28250-2452XL	20793531	1½	38.1	52x2.0	60	8.50	215.9	4.11	104.4	6.60	167.7	NS	Y

Descriptive #	Product #	SAP #	Hose Size ID		Thread Size (A)	Hex-1 Wrench Size	Drop (D)		Cut-Off (C)		Length (L)		Skive Type	SR12, ARC12
			in.	mm			mm	in.	mm	in.	mm			
SG-DLFX90-0822	29250-0822	20822146	1/2	12.7	22x1.5	27	1.59	40.4	1.57	39.9	3.11	78.9	NS	Y
SG-DLFX90-1230	29250-1230	20822144	3/4	19.1	30x2.0	36	2.32	58.9	2.05	52.1	3.92	99.6	NS	Y
SG-DLFX90-1636	29250-1636	20822143	1	25.4	36x2.0	41	2.68	68.0	3.07	78.0	5.35	136.0	NS	Y

## DIN 24° Heavy

Female | Swivel

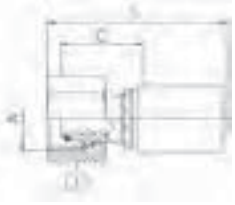

S=Skive  
NS=Non-Skive  
DG=Dual-Grip™

Descriptive #	Product #	SAP #	Hose Size ID		Thread Size (A)	Hex-1 Wrench Size	Cut-Off (C)		Length (L)		Skive Type	SR12, ARC12
			in.	mm			mm	in.	mm	in.		
S4-DHFX-0620	28210-0620	20241795	3/8	9.5	20x1.5	24	1.09	27.6	2.25	57.1	NS	Y
S4-DHFX-0622	28210-0622	20241806	3/8	9.5	22x1.5	27	1.22	31.1	2.44	62.1	NS	Y
S4-DHFX-0824	28210-0824	20241802	1/2	12.7	24x1.5	30	1.25	31.7	2.67	67.7	NS	Y
S4-DHFX-1030	28210-1030	20441177	5/8	15.9	30x2.0	36	1.44	36.5	2.93	74.3	NS	Y
S4-DHFX-1230	28210-1230	20441178	3/4	19.0	30x2.0	36	1.46	37.0	3.13	79.5	NS	Y
S4-DHFX-1236	28210-1236	20241798	3/4	19.0	36x2.0	46	1.58	40.2	3.39	86.2	NS	Y
S4-DHFX-1636	28210-1636	20441309	1	25.4	36x2.0	46	1.61	41.0	3.63	92.1	NS	Y
S4-DHFX-1642	28210-1642	20241827	1	25.4	42x2.0	50	1.70	43.1	3.65	92.7	NS	Y
S4-DHFX-2042	28210-2042	20241721	1¼	31.8	42x2.0	50	1.76	44.7	4.00	101.7	NS	Y
S4-DHFX-2052	28210-2052	20241818	1¼	31.8	52x2.0	60	1.89	48.1	4.18	106.1	NS	Y

Continued on next page

# DIN 24° Heavy

Female | Swivel Continued

Descriptive #	Product #	SAP #	Hose Size ID		Thread Size (A)	Hex-1 Wrench Size	Cut-Off (C)		Length (L)		Skive Type	SR12, ARC12
			in.	mm			in.	mm	in.	mm		
SG-DHFX-0620	29210-0620	20774066	3/8	9.5	20x1.5	24	1.21	30.8	2.67	67.8	NS	Y
SG-DHFX-0622	29210-0622	20822180	3/8	9.5	22x1.5	27	1.42	36.2	2.88	73.2	NS	Y
SG-DHFX-0824	29210-0824	20731609	1/2	12.7	24x1.5	30	1.44	36.5	2.79	70.7	NS	Y
SG-DHFX-1030	29210-1030	20822179	5/8	15.9	30x2.0	36	1.64	41.7	3.23	82.1	NS	Y
SG-DHFX-1230	29210-1230	20822178	3/4	19.0	30x2.0	36	1.6	40.7	3.33	84.5	NS	Y
SG-DHFX-1236	29210-1236	20774357	3/4	19.0	36x2.0	46	1.89	47.9	3.76	95.4	NS	Y
SG-DHFX-1236S	29210-1236S	20822177	3/4	19.0	36x2.0	46	1.89	47.9	3.76	95.4	NS	Y
SG-DHFX-1642	29210-1642	20822175	1	25.4	42x2.0	50	1.88	47.9	4.17	105.8	NS	Y

S: Stainless Steel

# DIN 24° Light



S=Skive  
NS=Non-Skive  
DG=Dual-Grip™

Descriptive #	Product #	SAP #	Hose Size ID		Thread Size (A)	Hex-1 Wrench Size	Cut-Off (C)		Length (L)		Skive Type	SR12, ARC12
			in.	mm			in.	mm	in.	mm		
SG-DLM-0822	29255-0822	20822140	1/2	12.7	22x1.5	22	1.10	28.0	2.64	67.0	NS	
SG-DLM-1230	29255-1230	20822139	3/4	19.1	30x2.0	32	1.35	34.3	3.22	81.8	NS	Y
SG-DLM-1636	29255-1636	20822138	1	25.4	36x2.0	36	1.50	38.2	3.79	96.2	NS	Y

# DIN 24° Heavy

Female | 45° Elbow | Swivel

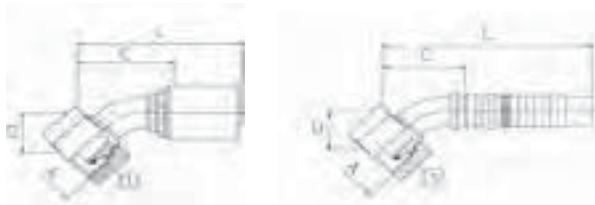

S=Skive  
NS=Non-Skive  
DG=Dual-Grip™

Descriptive #	Product #	SAP #	Hose Size ID		Thread Size (A)	Hex-1 Wrench Size	Drop (D)		Cut-Off (C)		Length (L)		Skive Type	SR12, ARC12
			in.	mm			in.	mm	in.	mm	in.	mm		
S4-DHFX45-1236	28215-1236	20441179	3/4	19.0	36x2.0	46	1.30	33.0	2.72	69.0	4.29	109.0	NS	Y

Descriptive #	Product #	SAP #	Hose Size ID		Thread Size (A)	Hex-1 Wrench Size	Drop (D)		Cut-Off (C)		Length (L)		Skive Type	SR12, ARC12
			in.	mm			in.	mm	in.	mm	in.	mm		
SG-DHFX45-0620	29215-0620	20822174	3/8	9.5	20x1.5	24	0.79	20.1	2.01	51.1	3.47	88.1	NS	Y
SG-DHFX45-0622	29215-0622	20822173	3/8	9.5	22x1.5	27	0.83	21.1	2.09	53.1	3.55	90.1	NS	Y
SG-DHFX45-0824	29215-0824	20822172	1/2	12.7	24x1.5	30	0.85	21.6	2.20	55.9	3.74	94.9	NS	Y
SG-DHFX45-1236	29215-1236	20822171	3/4	19.0	36x2.0	46	1.30	33.0	2.72	69.1	4.59	116.6	NS	Y
SG-DHFX45-1642	29215-1642	20822170	1	25.4	42x2.0	50	1.59	40.4	4.33	110.0	6.61	168.0	NS	Y

## DIN 24° Heavy

Female | 90° Elbow | Swivel



S=Skive  
NS=Non-Skive  
DG=Dual-Grip™

Descriptive #	Product #	SAP #	Hose Size ID		Thread Size (A)	Hex-1 Wrench Size	Drop (D)		Cut-Off (C)		Length (L)		Skive Type	SR12, ARC12
			in.	mm			mm	in.	mm	in.	mm	in.		
S4-DHFX90-0620	28220-0620	20241834	3/8	9.5	20x1.5	24	1.52	38.5	1.34	34.0	2.40	61.0	NS	Y
S4-DHFX90-0622	28220-0622	20241833	3/8	9.5	22x1.5	27	1.59	40.5	1.34	34.0	2.40	61.0	NS	Y
S4-DHFX90-0824	28220-0824	20241826	1/2	12.7	24x1.5	30	1.63	41.5	1.57	40.0	2.80	71.0	NS	Y
S4-DHFX90-1030	28220-1030	20241831	5/8	15.9	30x2.0	36	2.17	55.0	1.89	48.0	3.23	82.0	NS	Y
S4-DHFX90-1230	28220-1230	20441310	3/4	19.0	30x2.0	36	2.28	58.0	2.01	51.0	3.54	90.0	NS	Y
S4-DHFX90-1236	28220-1236	20441311	3/4	19.0	36x2.0	46	2.34	59.5	2.01	51.0	3.54	90.0	NS	Y
S4-DHFX90-1642	28220-1642	20441312	1	25.4	42x2.0	50	3.11	79.0	2.99	76.0	4.72	120.0	NS	Y
S4-DHFX90-2052	28220-2052	20265706	1 1/4	31.8	52x2.0	60	3.62	92.0	3.70	94.0	5.75	146.0	NS	Y

Descriptive #	Product #	SAP #	Hose Size ID		Thread Size (A)	Hex-1 Wrench Size	Drop (D)		Cut-Off (C)		Length (L)		Skive Type	SR12, ARC12
			in.	mm			mm	in.	mm	in.	mm	in.		
SG-DHFX90-0620	29220-0620	20822169	3/8	9.5	20x1.5	24	1.52	38.6	1.34	34.0	2.80	71.0	NS	Y
SG-DHFX90-0622	29220-0622	20822168	3/8	9.5	22x1.5	27	1.59	40.4	1.34	34.0	2.80	71.0	NS	Y
SG-DHFX90-0824	29220-0824	20731752	1/2	12.7	24x1.5	30	1.63	41.4	1.57	39.9	3.11	78.9	NS	Y
SG-DHFX90-1030	29220-1030	20822167	5/8	15.9	30x2.0	36	2.17	55.1	1.97	50.0	3.56	90.5	NS	Y
SG-DHFX90-1230	29220-1230	20822166	3/4	19.0	30x2.0	36	2.28	57.9	2.01	51.1	3.88	98.6	NS	Y
SG-DHFX90-1236	29220-1236	20822165	3/4	19.0	36x2.0	46	2.34	59.4	2.01	51.1	3.88	98.6	NS	Y
SG-DHFX90-1642	29220-1642	20822163	1	25.4	42x2.0	50	3.11	79.0	2.99	75.9	5.27	133.9	NS	Y

## DIN 24° Heavy

Male | Swivel



S=Skive  
NS=Non-Skive  
DG=Dual-Grip™

Descriptive #	Product #	SAP #	Hose Size ID		Thread Size (A)	Hex-1 Wrench Size	Cut-Off (C)		Length (L)		Skive Type	SR12, ARC12
			in.	mm			mm	in.	mm	in.		
SG-DHM-0824	29225-0824	20822160	1/2	12.7	24x1.5	24	1.22	31.0	2.76	70.0	NS	Y
SG-DHM-1230	29225-1230	20822159	3/4	19.1	30x2.0	32	1.44	36.5	3.31	84.0	NS	Y
SG-DHM-1236	29225-1236	20822158	1	25.4	26x2.0	36	1.60	40.6	3.47	88.1	NS	Y
SG-DHM-1642	29225-1642	20822157	1 1/4	31.8	42x2.0	46	1.82	46.2	4.10	104.2	NS	Y

## Japanese Komatsu® 30° Flare with Metric Threads

Female | Swivel

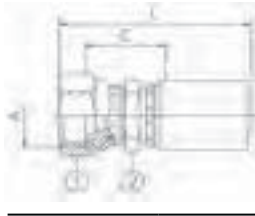

S=Skive  
NS=Non-Skive  
DG=Dual-Grip™

Descriptive #	Product #	SAP #	Hose Size ID		Thread Size (A)	Hex-1 Wrench Size	Hex-2 Wrench Size	Cut-Off (C)		Length (L)		Skive Type	SR12, ARC12
			in.	mm				in.	mm	in.	mm		
S4-KMFX-0822	28545-0822	20241885	1/2	12.7	22X1.5	27	22	0.93	23.6	2.62	66.6	NS	Y
S4-KMFX-1024	28545-1024	20441213	5/8	15.9	24x1.5	32	30	1.07	27.1	3.01	76.4	NS	Y
S4-KMFX-1230	28545-1230	20241887	3/4	19.0	30X1.5	36	30	1.09	27.6	3.35	85.1	NS	Y
S4-KMFX-1633	28545-1633	20241892	1	25.4	33X1.5	41	36	1.41	35.7	4.03	102.3	NS	Y
S4-KMFX-2036	28545-2036	20241889	1¼	31.8	36X1.5	46	46	1.71	43.5	4.63	117.5	NS	Y
S4-KMFX-2442	28545-2442	20241890	1½	38.1	42X1.5	55	55	1.73	44.0	5.04	128.0	NS	Y

Descriptive #	Product #	SAP #	Hose Size ID		Thread Size (A)	Hex-1 Wrench Size	Hex-2 Wrench Size	Cut-Off (C)		Length (L)		Skive Type	SR12, ARC12
			in.	mm				in.	mm	in.	mm		
SG-KMFX-0618	29545-0618	20821982	3/8	9.5	18x1.5	22		1.36	34.6	2.82	71.6	NS	Y
SG-KMFX-0822	29545-0822	20758298	1/2	12.7	22X1.5	27	22	1.47	37.3	3.00	76.3	NS	Y
SG-KMFX-1024	29545-1024	20821981	5/8	15.9	24x1.5	32	30	1.75	44.5	3.35	85.0	NS	Y
SG-KMFX-1230	29545-1230	20821980	3/4	19.0	30X1.5	36	30	1.95	49.5	3.82	97.0	NS	Y
SG-KMFX-1633	29545-1633	20821979	1	25.4	33X1.5	41	36	2.43	61.8	4.72	119.8	NS	Y

## Japanese Komatsu® 30° Flare with Metric Threads

Female | 45° Elbow | Swivel

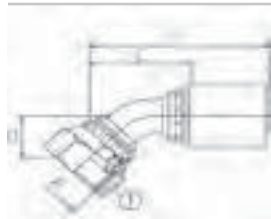

S=Skive  
NS=Non-Skive  
DG=Dual-Grip™

Descriptive #	Product #	SAP #	Hose Size ID		Thread Size (A)	Hex-1 Wrench Size	Drop (D)		Cut-Off (C)		Length (L)		Skive Type	SR12, ARC12
			in.	mm			in.	mm	in.	mm	in.	mm		
SG-KMFX45-0618	29548-0618	20821978	3/8	9.5	18x1.5	22	0.71	18.0	1.73	43.9	3.19	80.9	NS	Y
SG-KMFX45-0822	29548-0822	20821977	1/2	12.7	22X1.5	27	1.16	29.46	2.20	55.9	3.74	94.9	NS	Y

## Japanese Komatsu® 30° Flare with Metric Threads

Female | 90° Elbow | Swivel



S=Skive  
NS=Non-Skive  
DG=Dual-Grip™

Descriptive #	Product #	SAP #	Hose Size ID		Thread Size (A)	Hex-1 Wrench Size	Drop (D)		Cut-Off (C)		Length (L)		Skive Type	SR12 ARC12
			in.	mm			in.	mm	in.	mm	in.	mm		
SG-KMFX90-0618	29550-0618	20821976	3/8	9.5	18X1.5	22	1.40	35.6	1.42	36.1	2.88	73.1	NS	Y
SG-KMFX90-0822	29550-0822	20821975	1/2	12.7	22X1.5	27	2.09	53.1	1.74	44.1	3.27	83.1	NS	Y

## JIS 30° (Parallel Pipe Threads)

Female | Swivel

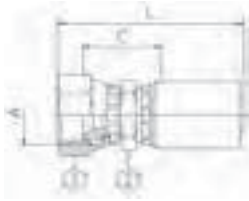

S=Skive  
NS=Non-Skive  
DG=Dual-Grip™

Descriptive #	Product #	SAP #	Hose Size ID		Thread Size (A)	Hex-1 Wrench Size	Hex-2 Wrench Size	Cut-Off (C)		Length (L)		Skive Type	SR12, ARC12
			in.	mm				in.	mm	in.	mm		
S4-JSFX-0808	28520-0808	20242056	1/2	12.7	1/2-14	27	22	0.93	23.6	2.62	66.6	NS	Y
S4-JSFX-1212	28520-1212	20242053	3/4	19.0	3/4-14	36	30	1.07	27.1	3.13	79.6	NS	Y
S4-JSFX-1616	28520-1616	20242059	1	25.4	1-11	41	36	1.30	32.9	3.64	92.5	NS	Y
S4-JSFX-2020 <sup>T</sup>	28520-2020	20241722	1¼	31.8	1¼-11	50	46	1.56	39.5	4.21	107.0	NS	Y

T: Thrust-Wire Nut (see "Fitting Identification" in Appendix for details)

Descriptive #	Product #	SAP #	Hose Size ID		Thread Size (A)	Hex-1 Wrench Size	Hex-2 Wrench Size	Cut-Off (C)		Length (L)		Skive Type	SR12, ARC12
			in.	mm				in.	mm	in.	mm		
SG-JSFX-0606	29520-0606	20821992	3/8	9.5	3/8-19	22	19	1.36	34.6	2.82	71.6	NS	Y
SG-JSFX-0808	29520-0808	20821991	1/2	12.7	1/2-14	27	22	1.47	37.2	3.00	76.3	NS	Y
SG-JSFX-1212	29520-1212	20821990	3/4	19.0	3/4-14	36	30	1.70	43.1	3.57	90.6	NS	Y
SG-JSFX-1616	29520-1616	20821989	1	25.4	1-11	41	36	2.05	52.1	4.33	110.1	NS	Y

# How to Use the Fitting Tables

This section lists ALL fittings that are compatible with the following hoses:

Hose Family	Hose Description
SR13	SAE 100R13/EN 856 R13
ARC13	SAE 100R13/EN 856 R13 (Abrasion Cover)
SR15	SAE 100R15
ARC15	SAE 100R15 (Abrasion Cover)
S4SP	EN 856 4SP
S4SH	EN 856 4SH

## Fitting Description

Fitting Type

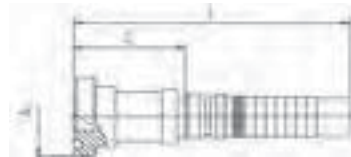

S=Skive  
NS=Non-Skive  
DG=Dual-Grip™

Descriptive #	Product #	SAP #	Hose Size ID		Thread Size (A)		Hex-1 Wrench Size		Cut-Off (C)		Length (L)		Skive Type	SR13, ARC13	SR15, ARC15	S4SP	S4SH
			in.	mm	in.	mm	in.	mm	in.	mm	in.	mm					
Ultra-Crimp, PN1	16300-1212	20254304	3/4	19.0	3/4	1.63	41.3	1.73	44.0	4.49	114.0	DG	DGF1-12	DGF1-12	DGF1-12	DGF1-12	
Ultra-Crimp, PN2	30300-1212	20241742	3/4	19.0	3/4	1.63	41.3	2.11	53.5	4.27	108.5	NS	Y				Y
Dual-Grip, PN3	36300-1212	20242607	3/4	19.0	3/4	1.63	41.3	2.07	52.5	3.62	92.0	S	Dual-Grip Ferrule PN			UCF2-12	

Choose fittings carefully considering the working pressure of both hose and fitting. The maximum working pressure of the hose assembly is the lesser of the rated working pressure of the hose and the fitting. See page 313 for working pressure.

A "Y" in the hose compatibility columns indicates that the fitting is an **Ultra-Crimp™** style fitting and that it works for that particular hose.

A **blank space** in the hose compatibility columns indicates that the fitting **DOES NOT** work for that particular hose.

A **Part Number (Ferrule)** in the hose compatibility columns indicates that the fitting is a **Uni-Crimp™** style. The fitting, along with the ferrule shown, work together as a unit for that particular hose.

# JIC 37° Flare (SAE J514)

Female | Swivel



S=Skive  
NS=Non-Skive  
DG=Dual-Grip™

Descriptive #	Product #	SAP #	Hose Size ID		Thread Size (A)	Hex-1 Wrench Size		Hex-2 Wrench Size		Cut-Off (C)		Length (L)		Skive Type	SR13, ARC13	SR15, ARC15	S4SP	S4SH
			in.	mm	in.	mm	in.	mm	in.	mm	in.	mm	in.					
DG-JCFX-1212 <sup>T1</sup>	16400-1212	20254271	3/4	19.0	1 1/16-12	1 1/4	32			0.74	18.7	3.82	97.0	DG	DGF1-12	DGF1-12	DGF1-12	DGF1-12
SG-JCFX-1212	30400-1212	20242042	3/4	19.0	1 1/16-12	1 1/4	32	1 1/16	27	1.19	30.2	3.92	99.5	NS	Y			Y
DG-JCFX-1616 <sup>T1</sup>	16400-1616	20242491	1	25.4	1 5/16-12	1 1/2	38			0.89	22.5	4.49	114.0	DG	DGF1-16	DGF1-16	DGF1-16	DGF1-16
SG-JCFX-1616	30400-1616	20241918	1	25.4	1 5/16-12	1 1/2	38	1 1/16	36	1.50	38.0	4.61	117.0	NS	Y			Y
SG-JCFX-1616S	30400-1616S	20672345	1	25.4	1 5/16-12	1 1/2	38	1 1/16	36	1.50	38.0	4.61	117.0	NS	Y			Y
DG-JCFX-2020 <sup>T1</sup>	16400-2020	20242398	1 1/4	31.8	1 5/8-12	2	50			1.01	25.7	5.06	128.5	DG	DGF2-20	DGF2-20		DGF1-20
SG-JCFX-2020	30400-2020	20577099	1 1/4	31.8	1 5/8-12	2	50	1 5/8	41	1.70	43.1	6.08	154.5	NS	Y			Y
SG-JCFX-2020S	30400-2020XS	20672346	1 1/4	31.8	1 5/8-12	2	50	1 5/8	41	1.70	43.1	6.08	154.5	NS	Y			Y
DG-JCFX-2424 <sup>T1</sup>	16400-2424	20242432	1 1/2	38.1	1 7/8-12	2 3/16	55			1.14	29.0	5.47	139.0	DG	DGF2-24	DGF2-24		DGF1-24
SG-JCFX-2424	30400-2424	20241922	1 1/2	38.1	1 7/8-12	2 3/16	55	2	50	1.94	49.4	5.94	151.0	NS	Y			
DG-JCFX-3232 <sup>T1</sup>	16400-3232	20254272	2	50.8	2 1/2-12	2 13/16	70			1.34	34.0	6.10	155.0	DG	DGF2-32			DGF1-32
SG-JCFX-3232	30400-3232	20242040	2	50.8	2 1/2-12	2 13/16	70	2 13/16	70	2.58	65.5	6.508	165.4	NS	Y			

Descriptive #	Product #	SAP #	Hose Size ID		Thread Size (A)	Hex-1 Wrench Size		Hex-2 Wrench Size		Cut-Off (C)		Length (L)		Skive Type	SR13, ARC13	SR15, ARC15	S4SP	S4SH
			in.	mm	in.	mm	in.	mm	in.	mm	in.	mm	in.					
SG-JCFX-0604	29400-0604	20822056	3/8	9.5	7/16-20	5/8	16	11/16	17	1.27	32.2	2.73	69.2	NS				
SG-JCFX-0606	29400-0606	20758248	3/8	9.5	9/16-18	3/4	19	11/16	17	1.32	33.6	2.78	70.6	NS				
SG-JCFX-0606S	29400-0606S	20822055	3/8	9.5	9/16-18	3/4	19	11/16	17	1.32	33.6	2.78	70.6	NS			Y	
SG-JCFX-0608	29400-0608	20758284	3/8	9.5	3/4-16	1	25	3/4	19	1.09	27.7	2.55	64.7	NS			Y	
SG-JCFX-0610	29400-0610	20822054	3/8	9.5	7/8-14	1 1/16	27	7/8	22	1.63	41.4	3.09	78.5	NS			Y	
SG-JCFX-0806	29400-0806	20822053	1/2	12.7	9/16-18	3/4	19	3/4	19	1.36	34.6	2.90	73.6	NS			Y	
SG-JCFX-0808	29400-0808	20753008	1/2	12.7	3/4-16	1	25	3/4	19	1.09	27.7	2.63	66.7	NS			Y	
SG-JCFX-0808S	29400-0808S	20822052	1/2	12.7	3/4-16	1	25	3/4	19	1.09	27.7	2.63	66.7	NS			Y	
SG-JCFX-0810	29400-0810	20758294	1/2	12.7	7/8-14	25/32	27	7/8	22	1.64	41.6	3.17	80.6	NS			Y	
SG-JCFX-0812 <sup>T</sup>	29400-0812	20758299	1/2	12.7	1 1/16-12	25/32	32	1	25	1.74	44.2	3.28	83.2	NS			Y	
SG-JCFX-1008	29400-1008	20822051	5/8	15.9	3/4-16	1	25	15/16	24	1.65	41.9	3.24	82.3	NS			Y	
SG-JCFX-1010	29400-1010	20822050	5/8	15.9	7/8-14	1 1/16	27	15/16	24	1.76	44.8	3.36	85.3	NS			Y	
SG-JCFX-1010S	29400-1010S	20822049	5/8	15.9	7/8-14	1 1/16	27	15/16	24	1.76	44.8	3.36	85.3	NS			Y	
SG-JCFX-1012 <sup>T</sup>	29400-1012	20822048	5/8	15.9	1 1/16-12	1 1/4	32	1	25	1.76	44.7	3.35	85.2	NS			Y	
SG-JCFX-1210	29400-1210	20822047	3/4	19.0	7/8-14	1 1/16	27	1 1/16	27	1.74	44.2	3.61	91.7	NS	Y	Y	Y	Y
SG-JCFX-1212 <sup>T</sup>	29400-1212	20822046	3/4	19.0	1 1/16-12	1 1/4	32	1 1/16	27	1.80	45.7	3.67	93.2	NS	Y	Y	Y	Y
SG-JCFX-1212S <sup>T</sup>	29400-1212S	20822045	3/4	19.0	1 1/16-12	1 1/4	32	1 1/16	27	1.80	45.7	3.67	93.2	NS	Y	Y	Y	Y
SG-JCFX-1214	29400-1214	20822044	3/4	19.0	1 3/8-12	1 7/16	36	1 1/4	32	1.87	47.5	3.74	95.0	NS	Y	Y	Y	Y
SG-JCFX-1216 <sup>T</sup>	29400-1216	20822043	3/4	19.0	1 5/8-12	1 1/2	38	1 1/4	32	1.46	37.1	3.33	84.6	NS	Y	Y	Y	Y
SG-JCFX-1612 <sup>T</sup>	29400-1612	20822042	1	25.4	1 1/16-12	1 1/4	32	1 1/4	32	1.42	36.1	3.71	94.1	NS	Y	Y	Y	Y
SG-JCFX-1616 <sup>T</sup>	29400-1616	20822041	1	25.4	1 5/16-12	1 1/2	38	1 1/4	32	2.12	53.7	4.40	111.7	NS	Y	Y	Y	Y
SG-JCFX-1616S <sup>T</sup>	29400-1616S	20822040	1	25.4	1 5/16-12	1 1/2	38	1 1/4	32	2.12	53.7	4.40	111.7	NS	Y	Y	Y	Y
SG-JCFX-1620 <sup>T</sup>	29400-1620	20822039	1	25.4	1 5/8-12	2	50	1 5/8	41	1.62	41.1	3.90	99.1	NS	Y	Y	Y	Y
SG-JCFX-2424	29400-2424	20757741	1 1/2	38.1	1 7/8-12	2 3/16	55			2.88	73.1	6.34	161.1	NS				Y
SG-JCFX-3232	29400-3232	20833298	2	50.8	2 1/2-12	2 13/16	70			3.41	86.5	6.95	176.5	NS				Y
SG-JCFX-3232S	29400-3232S	Contact Continental ContiTech	2	50.8	2 1/2-12	2 13/16	70			3.406	86.5	6.95	176.5	NS				Y

T: Thrust-Wire Nut (see "Fitting Identification" in Appendix for details)

S: Stainless Steel

1: Single Hex



# JIC 37° Flare (SAE J514)

Female | 45° Elbow | Swivel



S=Skive  
NS=Non-Skive  
DG=Dual-Grip™

Descriptive #	Product #	SAP #	Hose Size ID		Thread Size (A)		Hex-1 Wrench Size		Drop (D)		Cut-Off (C)		Length (L)		Skive Type	SR13, ARC13	SR15, ARC15	S4SP	S4SH
			in.	mm	in.	mm	in.	mm	in.	mm	in.	mm	in.	mm					
DG-JCFX45-1212	16420-1212	20254273	3/4	19.0	3/4-16	1 1/4	32	1.08	2.75	2.60	66.0	5.40	137.2	DG	DGF1-12	DGF1-12	DGF1-12	DGF1-12	
S6-JCFX45-1212	30420-1212	20241952	3/4	19.0	1 1/8-12	1 1/4	32	1.08	2.75	2.76	70.0	5.20	132.2	NS	Y			Y	
DG-JCFX45-1616	16420-1616	20254274	1	25.4	1 1/8-12	1 1/2	38	1.22	3.10	3.15	80.0	6.46	164.0	DG	DGF1-16	DGF1-16	DGF1-16	DGF1-16	
S6-JCFX45-1616	30420-1616	20241959	1	25.4	1 1/8-12	1 1/2	38	1.22	3.10	3.35	85.0	6.16	156.5	NS	Y			Y	
DG-JCFX45-2020	16420-2020	20254275	1 1/4	31.8	1 1/8-12	2	50	1.46	3.70	3.66	93.0	7.39	187.8	DG	DGF2-20	DGF2-20		DGF1-20	
S6-JCFX45-2020	30420-2020	20577100	1 1/4	31.8	1 1/8-12	2	50	1.46	3.70	3.90	99.0	7.99	203.0	NS	Y			Y	
S6-JCFX45-2424	30420-2424	20424976	1 1/2	38.1	1 1/8-12	2 3/16	55	1.71	4.35	4.65	118.0	8.64	219.5	NS	Y				
S6-JCFX45-3232	30420-3232	20788106	2	50.8	2 1/2-12	2 13/16	70	2.76	7.01	6.54	166.1	10.5	266.7	NS	Y				

Descriptive #	Product #	SAP #	Hose Size ID		Thread Size (A)		Hex-1 Wrench Size		Drop (D)		Cut-Off (C)		Length (L)		Skive Type	SR13, ARC13	SR15, ARC15	S4SP	S4SH
			in.	mm	in.	mm	in.	mm	in.	mm	in.	mm	in.	mm					
SG-JCFX45-0606	29240-0606	20758293	3/8	9.5	9/16-18	3/4	19	0.43	11.0	1.81	46.0	3.27	83.0	NS			Y		
SG-JCFX45-0608	29240-0608	20822038	3/8	9.5	3/4-16	1	25	0.59	15.0	1.85	47.0	3.31	84.0	NS			Y		
SG-JCFX45-0808	29240-0808	20758293	1/2	12.7	3/4-16	1	25	0.59	15.0	2.08	52.9	3.62	91.9	NS			Y		
SG-JCFX45-0810	29240-0810	20822037	1/2	12.7	7/8-14	1 1/16	27	0.63	16.0	2.01	51.0	3.54	90.0	NS			Y		
SG-JCFX45-1010	29240-1010	20822036	5/8	15.9	7/8-14	1 1/16	27	0.63	16.0	1.76	44.8	4.15	105.5	NS			Y		
SG-JCFX45-1012 <sup>T</sup>	29240-1012	20822035	5/8	15.9	7/8-14	1 1/4	32	0.90	22.9	2.56	65.0	4.15	105.5	NS			Y		
SG-JCFX45-1212 <sup>T</sup>	29420-1212	20822034	3/4	19.0	1 1/8-12	1 1/4	32	1.08	27.4	2.79	70.8	4.91	124.8	NS	Y	Y	Y	Y	
SG-JCFX45-1216	29420-1216	20822033	3/4	19.0	1 1/8-12	1 1/2	38	1.02	26.0	2.80	71.0	4.67	118.5	NS	Y	Y	Y	Y	
SG-JCFX45-1616 <sup>T</sup>	29420-1616	20822032	1	25.4	1 1/8-12	1 1/2	38	1.19	30.1	3.30	83.7	5.58	141.7	NS	Y	Y	Y	Y	
SG-JCFX45-1616S <sup>T</sup>	29420-1616S	20822031	1	25.4	1 1/8-12	1 1/2	38	1.19	30.1	3.30	83.7	5.58	141.7	NS	Y	Y	Y	Y	
SG-JCFX45-1620 <sup>T</sup>	29420-1620	20822030	1	25.4	1 1/8-12	2	50	1.25	31.8	3.37	85.6	5.65	143.6	NS	Y	Y	Y	Y	
SG-JCFX45-2424	29420-2424	20757727	1 1/2	38.1	1 7/8-12			Contact Continental ContiTech						NS				Y	

T: Thrust-Wire Nut (see "Fitting Identification" in Appendix for details)

# JIC 37° Flare (SAE J514)

Female | 90° Elbow | Swivel

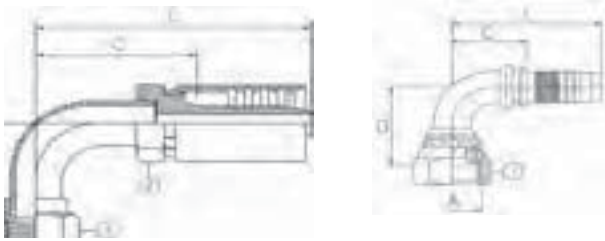

Elbow Type  
LT=Long Tube  
ST=Short Tube

S=Skive  
NS=Non-Skive  
DG=Dual-Grip™

Descriptive #	Product #	SAP #	Hose Size ID		Thread Size (A)		Hex-1 Wrench Size		Elbow Type		Drop (D)		Cut-Off (C)		Length (L)		Skive Type	SR13, ARC13	SR15, ARC15	S4SP	S4SH
			in.	mm	in.	mm	in.	mm	in.	mm	in.	mm	in.	mm	in.	mm					
DG-JCFX90-1212	16425-1212	20254276	3/4	19.0	1 1/16-12	1 1/4	32				2.24	57.0	1.77	45.0	4.29	109.0	DG	DGF1-12	DGF1-12	DGF1-12	DGF1-12
S6-JCFX90-1212	30425-1212	20241899	3/4	19.0	1 1/16-12	1 1/4	32				2.24	57.0	2.32	59.0	4.49	114.0	NS	Y			Y
DG-JCFX90-1616 <sup>DG</sup>	16425-1616	20242347	1	25.4	1 3/16-12	1 1/2	38				2.64	67.0	2.80	71.0	5.83	148.0	DG	DGF1-16	DGF1-16	DGF1-16	DGF1-16
S6-JCFX90-1616	30425-1616	20241927	1	25.4	1 3/16-12	1 1/2	38				2.64	67.0	2.99	76.0	5.51	140.0	NS	Y			Y
DG-JCFX90-2020 <sup>DG</sup>	16425-2020	20242348	1 1/4	31.8	1 5/8-12	2	50				3.07	78.0	3.11	79.0	6.50	165.0	DG	DGF2-20	DGF2-20		DGF1-20
S6-JCFX90-2020	30425-2020	20577101	1 1/4	31.8	1 5/8-12	2	50				3.07	78.0	3.31	84.0	7.09	180.0	NS	Y			Y
DG-JCFX90-2424 <sup>DG</sup>	16425-2424	20254277	1 1/2	38.1	1 7/8-12	2 3/16	55				3.62	92.0	3.70	94.0	7.28	185.0	DG	DGF2-24	DGF2-24		DGF1-24
S6-JCFX90-2424	30425-2424	20241905	1 1/2	38.1	1 7/8-12	2 3/16	55				3.62	92.0	4.13	105.0	7.40	188.0	NS	Y			
S6-JCFX90-3232	30425-3232	20788107	2	50.8	2 1/2-12	2 9/16	70				5.51	140.2	5.71	145.0	9.64	244.9	NS	Y			

Descriptive #	Product #	SAP #	Hose Size ID		Thread Size (A)		Hex-1 Wrench Size		Elbow Type		Drop (D)		Cut-Off (C)		Length (L)		Skive Type	SR13, ARC13	SR15, ARC15	S4SP	S4SH
			in.	mm	in.	mm	in.	mm	in.	mm	in.	mm	in.	mm							
SG-JCFX90-0604	29425-0604	20822029	3/8	9.525	7/16-29	5/8	16				1.26	32.0	1.38	35.0	2.84	72.0	NS			Y	
SG-JCFX90L-0604	29440-0604	20822018	3/8	9.525	7/16-29	5/8	16	LT			1.81	46.0	1.22	31.0	2.68	68.0	NS			Y	
SG-JCFX90-0606	29425-0606	20758283	3/8	9.525	9/16-18	3/4	19				1.50	38.0	1.22	31.0	2.67	67.7	NS			Y	
SG-JCFX90L-0606	29440-0606	20822017	3/8	9.525	9/16-18	3/4	19	LT			2.13	54.0	1.69	43.0	3.15	80.0	NS			Y	
SG-JCFX90S-0606	29445-0606	20822008	3/8	9.525	9/16-18	3/4	19	ST			0.91	23.0	1.69	42.0	3.11	79.0	NS			Y	
SG-JCFX90-0608	29425-0608	20822028	3/8	9.525	3/4-16	1	25				1.61	41.0	1.54	39.0	2.99	76.0	NS			Y	
SG-JCFX90L-0608	29440-0608	20822016	3/8	9.525	3/4-16	1	25	LT			2.52	64.0	1.85	47.0	3.31	84.0	NS			Y	
SG-JCFX90S-0608	29445-0608	20822007	3/8	9.525	3/4-16	1	25	ST			1.85	47.0	1.93	49.0	3.39	86.0	NS			Y	
SG-JCFX90-0808	29425-0808	20758292	1/2	12.7	3/4-16	1	25				1.58	40.0	1.49	37.9	3.03	76.9	NS			Y	
SG-JCFX90L-0808	29440-0808	20822015	1/2	12.7	3/4-16	1	25	LT			2.52	64.0	2.01	50.9	3.54	89.9	NS			Y	
SG-JCFX90S-0808	29445-0808	20822006	1/2	12.7	3/4-16	1	25	ST			1.14	29.0	1.81	46.0	3.38	85.9	NS			Y	
SG-JCFX90-0810	29425-0810	20822027	1/2	12.7	7/8-14	1 1/16	27				1.85	47.0	1.69	43.0	3.23	82.0	NS			Y	
SG-JCFX90L-0810	29440-0810	20822014	1/2	12.7	7/8-14	1 1/16	27	LT			2.76	70.0	1.46	37.0	2.99	76.0	NS			Y	
SG-JCFX90S-0810	29445-0810	20822005	1/2	12.7	7/8-14	1 1/16	27	ST			1.26	32.0	1.81	46.0	3.38	85.9	NS			Y	
SG-JCFX90-0812	29445-0812	20822026	1/2	12.7	1 1/16-12	1 1/4	32				1.81	46.0	1.49	37.9	3.03	76.9	NS			Y	
SG-JCFX90-1010	29425-1010	20822025	5/8	15.9	7/8-14	1 1/16	27				1.85	47.0	1.76	44.8	3.52	89.5	NS			Y	
SG-JCFX90L-1010	29440-1010	20822013	5/8	15.9	7/8-14	1 1/16	27	LT			2.76	70.0	1.76	44.8	3.56	90.5	NS			Y	
SG-JCFX90S-1010	29445-1010	20822004	5/8	15.9	7/8-14	1 1/16	27	ST			1.26	32.0	1.76	44.8	3.52	89.5	NS			Y	
SG-JCFX90-1012 <sup>T</sup>	29425-1012	20822024	5/8	15.9	1 1/16-12	1 1/4	32				2.28	58.0	2.35	59.7	3.94	100.2	NS			Y	
SG-JCFX90L-1012 <sup>T</sup>	29440-1012	20822012	5/8	15.9	1 1/16-12	1 1/4	32	LT			3.78	96.0	2.35	59.7	3.94	100.2	NS			Y	
SG-JCFX90-1210	29425-1210	20822023	3/4	19.0	7/8-14	1 1/16	27				1.85	47.0	1.97	50.0	3.84	97.5	NS	Y	Y	Y	Y
SG-JCFX90L-1210	29440-1210	20822011	3/4	19.0	7/8-14	1 1/16	27	LT			2.76	70.0	1.97	50.0	3.84	97.5	NS	Y	Y	Y	Y
SG-JCFX90S-1210	29445-1210	20822003	3/4	19.0	7/8-14	1 1/16	27	ST			1.26	32.0	1.97	50.0	3.84	97.5	NS	Y	Y	Y	Y
SG-JCFX90-1212 <sup>T</sup>	29425-1212	20822022	3/4	19.0	1 1/16-12	1 1/4	32				2.24	56.9	2.35	59.7	4.22	107.2	NS	Y	Y	Y	Y
SG-JCFX90L-1212 <sup>T</sup>	29440-1212	20822010	3/4	19.0	1 1/16-12	1 1/4	32	LT			3.78	96.0	2.35	59.7	4.22	107.2	NS	Y	Y	Y	Y
SG-JCFX90S-1212 <sup>T</sup>	29445-1212	20822002	3/4	19.0	1 1/16-12	1 1/4	32	ST			1.89	48.0	2.35	59.7	4.22	107.2	NS	Y	Y	Y	Y
SG-JCFX90-1216 <sup>T</sup>	29425-1216	20822021	3/4	19.0	1 5/16-12	1 1/2	38				2.80	71.0	2.35	59.7	4.22	107.2	NS	Y	Y	Y	Y
SG-JCFX90-1616 <sup>T</sup>	29425-1616	20822020	1	25.4	1 5/16-12	1 1/2	38				2.80	71.0	2.97	75.5	5.25	133.5	NS	Y	Y	Y	Y
SG-JCFX90L-1616 <sup>T</sup>	29440-1616	20822009	1	25.4	1 5/16-12	1 1/2	38	LT			4.49	114.0	3.10	78.7	5.38	136.7	NS	Y	Y	Y	Y
SG-JCFX90S-1616 <sup>T</sup>	29445-1616	20822001	1	25.4	1 5/16-12	1 1/2	38	ST			2.44	61.9	2.55	64.8	4.83	122.8	NS	Y	Y	Y	Y
SG-JCFX90-1620 <sup>T</sup>	29425-1620	20822019	1	25.4	1 5/8-12	2	50				3.07	78.0	2.87	72.9	5.15	130.9	NS	Y	Y	Y	Y
SG-JCFX90-2424	29425-2424	20757723	1 1/2	38.1	1 7/8-12						Contact Continental ContiTech						NS				Y

T: Thrust-Wire Nut (see "Fitting Identification" in Appendix for details)

DG: Part listed is Dual-Grip™ style (image is Uni-Crimp™ style)

# JIC 37° Flare (SAE J514)

Male

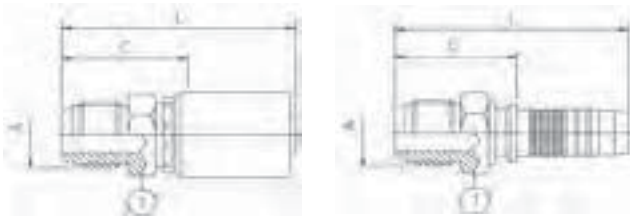

S=Skive  
NS=Non-Skive  
DG=Dual-Grip™

Descriptive #	Product #	SAP #	Hose Size ID		Thread Size (A)		Hex-1 Wrench Size		Cut-Off (C)		Length (L)		Skive Type	SR13, ARC13	SR15, ARC15	S4SP	S4SH
			in.	mm	in.	mm	in.	mm	in.	mm	in.	mm					
S6-JCM-1212	30450-1212		3/4	19.0	1 1/16-12	1 1/16	27	1.52	38.5	3.68	93.5	NS	Y				Y
DG-JCM-1616	16450-1616		1	25.4	1 5/16-12	1 7/16	36	1.30	33.0	4.63	117.5	DG	DGF1-16	DGF1-16	DGF1-16	DGF1-16	DGF1-16
S6-JCM-1616	30450-1616	20424979	1	25.4	1 5/16-12	1 7/16	36	1.79	45.5	4.31	109.5	NS	Y				Y
DG-JCM-2020	16450-2020	20242353	1 1/4	31.8	1 3/8-12	1 13/16	46	1.39	35.3	5.22	132.5	DG	DGF2-20	DGF2-20			DGF1-20
S6-JCM-2020	30450-2020	20563020	1 1/4	31.8	1 3/8-12	1 13/16	46	2.03	51.5	5.79	147.0	NS	Y				Y
DG-JCM-2424	16450-2424	20242352	1 1/2	38.1	1 7/8-12	2	50	1.54	39.0	5.57	141.5	DG	DGF2-24	DGF2-24			DGF1-24
S6-JCM-2424	30450-2424	20424981	1 1/2	38.1	1 7/8-12	2	50	2.26	57.5	5.53	140.5	NS	Y				
S6-JCM-3232	30450-3232	20788108	2	50.8	2 1/2-12	2 13/16	70	2.83	71.8	6.76	171.6	NS	Y				

Descriptive #	Product #	SAP #	Hose Size ID		Thread Size (A)		Hex-1 Wrench Size		Cut-Off (C)		Length (L)		Skive Type	SR13, ARC13	SR15, ARC15	S4SP	S4SH
			in.	mm	in.	mm	in.	mm	in.	mm	in.	mm					
SG-JCM-0606	29450-0606	20758249	3/8	9.5	9/16-18	11/16	17	1.15	29.1	2.60	66.1	NS				Y	
SG-JCM-0608	29450-0608	20758285	3/8	9.5	3/4-16	3/4	19	1.29	32.8	2.75	69.9	NS				Y	
SG-JCM-0610	29450-0610	20822000	3/8	9.5	7/8-14	15/16	24	1.45	36.8	2.91	73.8	NS				Y	
SG-JCM-0808	29450-0808	20758291	1/2	12.7	3/4-16	3/4	19	1.29	32.8	2.83	71.9	NS				Y	
SG-JCM-0810	29450-0810	20758296	1/2	12.7	7/8-14	15/16	24	1.45	36.8	2.99	75.8	NS				Y	
SG-JCM-0812	29450-0812	20758295	1/2	12.7	1 1/16-12	1 1/16	27	1.54	39.1	3.07	78.1	NS				Y	
SG-JCM-1010	29450-1010	20821999	5/8	15.9	7/8-14	15/16	24	1.47	37.3	3.06	77.8	NS				Y	
SG-JCM-1012	29450-1012	20821998	5/8	15.9	7/8-14	1 1/16	27	1.56	39.6	3.15	80.1	NS	Y	Y	Y	Y	Y
SG-JCM-1212	29450-1212	20821997	3/4	19.0	1 1/16-12	1 1/16	27	1.60	40.6	3.47	88.1	NS	Y	Y	Y	Y	Y
SG-JCM-1214	29450-1229	20821996	3/4	19.0	1 3/16-12	1 1/4	32	1.73	43.9	3.60	91.4	NS	Y	Y	Y	Y	Y
SG-JCM-1216	29450-1216	20821995	3/4	19.0	1 5/16-12	1 7/16	36	1.77	45.1	3.66	93.1	NS	Y	Y	Y	Y	Y
SG-JCM-1616	29450-1616	20821994	1	25.4	1 5/16-12	1 7/16	36	1.83	46.6	4.12	104.6	NS	Y	Y			Y
SG-JCM-1620	29450-1620	20821993	1	25.4	1 3/8-12	1 13/16	46	1.99	50.5	4.27	108.6	NS					Y
SG-JCM-2424	29450-2424	20757728	1 1/2	38.1	1 7/8-12	2	50	2.54	64.6	6.01	152.6	NS					Y
SG-JCM-3232	29450-3232	20833302	2	50.8	2 1/2-12	2 7/8	70	2.974	75.5	6.52	165.6	NS					Y

# NPTF

Female

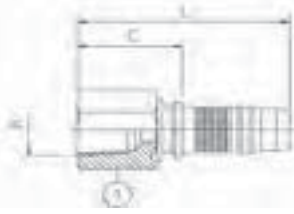

S=Skive  
NS=Non-Skive  
DG=Dual-Grip™

Descriptive #	Product #	SAP #	Hose Size ID		Thread Size (A)		Hex-1 Wrench Size		Cut-Off (C)		Length (L)		Skive Type	SR13, ARC13	SR15, ARC15	S4SP	S4SH
			in.	mm	in.	mm	in.	mm	in.	mm	in.	mm					
SG-NPF-0808	29600-0808	20821973	1/2	12.7	1/2-14	1	25	1.48	37.6	3.02	76.6	NS			Y		

# NPTF

Male

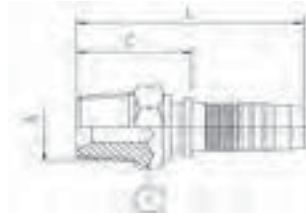
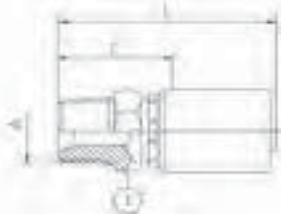

S=Skive  
NS=Non-Skive  
DG=Dual-Grip™

Descriptive #	Product #	SAP #	Hose Size ID		Thread Size (A)		Hex-1 Wrench Size		Cut-Off (C)		Length (L)		Skive Type	SR13, ARC13	SR15, ARC15	S4SP	S4SH
			in.	mm	in.	mm	in.	mm	in.	mm	in.	mm					
DG-NPM-1212	16615-1212	20242574	3/4	19.0	3/4-14	1 1/16	27	1.02	26.0	3.78	96.0	DG	DGF1-12	DGF1-12	DGF1-12	DGF1-12	
S6-NPM-1212	30615-1212	20385938	3/4	19.0	3/4-14	1 1/16	27	1.40	35.5	3.56	90.5	NS	Y				Y
DG-NPM-1616	16615-1616	20242518	1	25.4	1-11 1/2	1 7/16	36	1.34	34.0	4.67	118.5	DG	DGF1-16	DGF1-16	DGF1-16	DGF1-16	
S6-NPM-1616	30615-1616	20293311	1	25.4	1-11 1/2	1 7/16	36	1.83	46.5	4.35	110.5	NS	Y				Y
DG-NPM-2020	16615-2020	20242437	1 1/4	31.8	1 1/4-11 1/2	1 13/16	46	1.41	35.8	5.24	133.0	DG	DGF2-20	DGF2-20			DGF1-20
S6-NPM-2020	30615-2020	20577103	1 1/4	31.8	1 1/4-11 1/2	1 13/16	46	2.05	52.0	5.81	147.5	NS	Y				Y
DG-NPM-2424	16615-2424	20242354	1 1/2	38.1	1 1/2-11 1/2	2	50	1.56	39.5	5.49	139.5	DG	DGF2-24	DGF2-24			DGF1-24
S6-NPM-2424	30615-2424	20293313	1 1/2	38.1	1 1/2-11 1/2	2	50	2.19	55.5	5.45	138.5	NS	Y				
DG-NPM-3232	16615-3232	20242401	2	50.8	2-11 1/2	2 9/16	65	1.54	39.2	5.91	150.2	DG	DGF2-32				DGF1-32
S6-NPM-3232	30615-3232	20293314	2	50.8	2-11 1/2	2 13/16	70	2.53	64.1	6.45	163.9	NS	Y				

Descriptive #	Product #	SAP #	Hose Size ID		Thread Size (A)		Hex-1 Wrench Size		Cut-Off (C)		Length (L)		Skive Type	SR13, ARC13	SR15, ARC15	S4SP	S4SH
			in.	mm	in.	mm	in.	mm	in.	mm	in.	mm					
SG-NPM-0604	29615-1608	20731608	3/8	9.5	1/4-18	11/16	17	1.17	29.7	2.63	66.8	NS			Y		
SG-NPM-0606	29615-0606	20731748	3/8	9.5	3/8-18	3/4	19	1.20	30.5	2.66	67.5	NS			Y		
SG-NPM-0606S	29615-0606S	20821971	3/8	9.5	3/8-18	3/4	19	1.20	30.5	2.66	67.5	NS			Y		
SG-NPM-0608	29615-0608	20758280	3/8	9.5	1/2-14	7/8	22	1.37	34.9	2.83	71.9	NS			Y		

S: Stainless Steel

Continued on next page

# NPTF

## Male Continued

Descriptive #	Product #	SAP #	Hose Size ID		Thread Size (A)		Hex-1 Wrench Size		Cut-Off (C)		Length (L)		Skive Type	SR13, ARC13	SR15, ARC15	S4SP	S4SH
			in.	mm	in.	mm	in.	mm	in.	mm	in.	mm					
SG-NPM-0806	29615-0806	20731755	1/2	12.7	3/8-18	3/4	19	1.20	30.5	2.73	69.4	NS				Y	
SG-NPM-0808	29615-0808	20753007	1/2	12.7	1/2-14	7/8	22	1.37	34.9	2.91	73.9	NS				Y	
SG-NPM-0808S	29615-0808S	20821970	1/2	12.7	1/2-14	7/8	22	1.37	34.9	2.91	73.9	NS				Y	
SG-NPM-0812	29615-0812	20758303	1/2	12.7	3/4-14	1 1/16	27	1.42	36.0	2.95	75.0	NS				Y	
SG-NPM-1012	29615-1012	20821969	5/8	15.9	3/4-14	1 1/16	27	1.44	36.5	3.03	77.0	NS				Y	
SG-NPM-1208	29615-1208	20821968	3/4	19.0	1/2-14	1 1/16	27	1.43	36.4	3.30	83.9	NS	Y	Y	Y	Y	Y
SG-NPM-1212	29615-1212	20821967	3/4	19.0	3/4-14	1 1/16	27	1.48	37.5	3.35	85.0	NS	Y	Y	Y	Y	Y
SG-NPM-1212S	29615-1212S	20821966	3/4	19.0	3/4-14	1 1/16	27	1.48	37.5	3.35	85.0	NS	Y	Y	Y	Y	Y
SG-NPM-1216	29615-1216	20821965	3/4	19.0	1-11 1/2	1 7/16	36	1.83	46.6	3.70	94.1	NS	Y	Y	Y	Y	Y
SG-NPM-1612	29615-1612	20821964	1	25.4	3/4-14	1 7/16	36	1.70	43.2	3.99	101.2	NS	Y	Y	Y	Y	Y
SG-NPM-1616	29615-1616	20821963	1	25.4	1-11 1/2	1 7/16	36	1.89	48.1	4.18	106.1	NS	Y	Y	Y	Y	Y
SG-NPM-1616S	29615-1616S	20821962	1	25.4	1-11 1/2	1 7/16	36	1.89	48.1	4.18	106.1	NS	Y	Y	Y	Y	Y
SG-NPM-1620	29615-1620	20821961	1	25.4	1 1/4-11 1/2	1 13/16	46	2.03	51.5	4.31	109.5	NS	Y	Y	Y	Y	Y
SG-NPM-2424	29615-2424	20757742	1 1/2	38.1	1 1/2-11 1/2	2	50	2.46	62.4	5.92	150.4	NS					Y
SG-NPM-3232	29615-3232	20833301	2	50.8	2-11 1/2	2 13/16	70	2.67	67.9	6.22	157.9	NS					Y

S: Stainless Steel

# NPTF

## Male | Swivel



S=Skive  
NS=Non-Skive  
DG=Dual-Grip™

Descriptive #	Product #	SAP #	Hose Size ID		Thread Size (A)		Hex-1 Wrench Size		Cut-Off (C)		Length (L)		Skive Type	SR13, ARC13	SR15, ARC15	S4SP	S4SH
			in.	mm	in.	mm	in.	mm	in.	mm	in.	mm					
SG-NPMX-0604	29645-0604	20821959	3/8	9.5	1/4-18	11/16	17	1.67	42.3	3.123	79.3	NS				Y	
SG-NPMX-0606	29645-0606	20821958	3/8	9.5	3/8-18	7/8	22	1.58	40.1	3.037	77.1	NS				Y	
SG-NPMX-0608	29645-0608	20821957	3/8	9.5	1/2-14	1	25	1.73	44.0	3.188	81.0	NS				Y	
SG-NPMX-0806	29645-0806	20821956	1/2	12.7	3/8-18	7/8	22	1.58	40.1	3.116	79.1	NS				Y	
SG-NPMX-0808	29645-0808	20821955	1/2	12.7	1/2-14	1	25	1.73	44.0	3.267	83.0	NS				Y	
SG-NPMX-1212	29645-1212	20821954	3/4	19.1	3/4-14	1 1/4	32	2.08	52.8	3.95	100.3	NS	Y	Y	Y	Y	Y
SG-NPMX-1616	29645-1616	20821953	1	25.4	1-11 1/2	1 3/4	41	2.40	60.9	4.681	118.9	NS	Y	Y	Y	Y	Y

# NPT

Male API

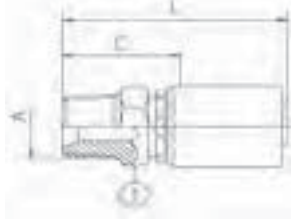

S=Skive  
NS=Non-Skive  
DG=Dual-Grip™

Descriptive #	Product #	SAP #	Hose Size ID		Thread Size (A)		Hex-1 Wrench Size		Cut-Off (C)		Length (L)		Skive Type	SR13, ARC13	SR15, ARC15	S4SP	S4SH
			in.	mm	in.	mm	in.	mm	in.	mm	in.	mm					
S6-NPM-API-1616	30617-1616	20466169	1	25.4	1-11½	17/16	36	2.66	67.5	5.18	131.5	NS	Y				Y
S6-NPM-API-2020	30617-2020	20466171	1¼	31.8	1¼-11½	1¾	46	2.94	74.6	6.70	170.1	NS	Y				Y
S6-NPM-API-2424	30617-2424	20466174	1½	38.1	1½-11½	2	50	3.27	83.0	6.54	166.0	NS	Y				
S6-NPM-API-3232	30618-3232	20679658	2	50.8	2-11½	2¾	70	4.20	106.8	8.13	206.6	NS	Y				
DG-NPM-API-3232	16630-3232	20466175	2	50.8	2-11½	2¾	65	3.76	95.5	7.58	192.5	DG	DGF2-32				DGF2-32

Descriptive #	Product #	SAP #	Hose Size ID		Thread Size (A)		Hex-1 Wrench Size		Cut-Off (C)		Length (L)		Skive Type	SR13, ARC13	SR15, ARC15	S4SP	S4SH
			in.	mm	in.	mm	in.	mm	in.	mm	in.	mm					
SG-NPM-API-1616	29617-1616	20821960	1	25.4	1-11½ API API5B	17/16	36	2.72	69.0	5.00	127.0	NS	Y	Y	Y	Y	Y
SG-NPM-API-3232	29617-2424	20833300	2	50.8	2-11½ API API5B	2¾	70	4.35	110.5	7.90	200.5	NS					Y

# NPSM

Female | Swivel

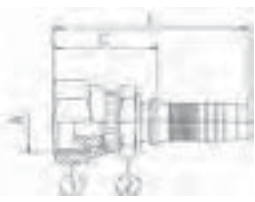

S=Skive  
NS=Non-Skive  
DG=Dual-Grip™

Descriptive #	Product #	SAP #	Hose Size ID		Thread Size (A)		Hex-1 Wrench Size		Hex-2 Wrench Size		Cut-Off (C)		Length (L)		Skive Type	SR13, ARC13	SR15, ARC15	S4SP	S4SH
			in.	mm	in.	mm	in.	mm	in.	mm	in.	mm	in.	mm					
SG-NSFX-0606	29655-0606	20821948	3/8	9.5	3/8-18	7/8	22	17	11/16	1.29	32.8	2.75	69.8	NS				Y	
SG-NSFX-0808	29655-0808	20821947	1/2	12.7	1/2-14	1¾	27	22	7/8	1.41	35.8	2.95	74.8	NS				Y	

# Standpipe



S=Skive  
NS=Non-Skive  
DG=Dual-Grip™

Descriptive #	Product #	SAP #	Hose Size ID		Tube OD (A)	Cut-Off (C)		Length (L)		Skive Type	SR13, ARC13	SR15, ARC15	S4SP	S4SH
			in.	mm	mm	in.	mm	in.	mm					
SG-SP-1628	29825-1628	20821784	1	25.4	28	1.73	43.9	4.01	101.9	NS	Y	Y	Y	Y

# O-Ring Face Seal (SAE J1453 ORS/ORFS)

Female | Swivel

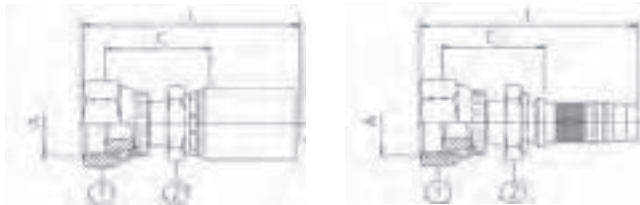

S=Skive  
NS=Non-Skive  
DG=Dual-Grip™

Descriptive #	Product #	SAP #	Hose Size ID		Thread Size (A)	Hex-1 Wrench Size		Hex-2 Wrench Size		Cut-Off (C)		Length (L)		Skive Type	SR13, ARC13	SR15, ARC15	S4SP	S4SH
			in.	mm	in.	mm	in.	mm	in.	mm	in.	mm	in.					
DG-OFFX-1212	16700-1212	20254278	3/4	19.0	1 3/16-12	1 7/16	36	1 3/16	30	1.57	40.0	4.67	118.5	DG	DGF1-12	DGF1-12	DGF1-12	DGF1-12
S6-OFFX-1212	30700-1212	20242191	3/4	19.0	1 3/16-12	1 7/16	36	1 3/16	30	1.75	44.5	4.49	114.0	NS	Y			Y
DG-OFFX-1216	16700-1216	20254279	3/4	19.0	1 7/16-12	1 5/8	41	1 7/16	36	1.69	43.0	4.80	121.8	DG	DGF1-12	DGF1-12	DGF1-12	DGF1-12
S6-OFFX-1216	30700-1216	20242150	3/4	19.0	1 7/16-12	1 5/8	41	1 7/16	36	1.79	45.5	4.54	115.3	NS	Y			Y
DG-OFFX-1616	16700-1616	20242458	1	25.4	1 7/16-12	1 5/8	41	1 7/16	36	1.85	47.0	5.44	138.3	DG	DGF1-16	DGF1-16	DGF1-16	DGF1-16
S6-OFFX-1616	30700-1616	20242139	1	25.4	1 7/16-12	1 5/8	41	1 7/16	36	1.95	49.5	5.05	128.3	NS	Y			Y
DG-OFFX-1620	16700-1620	20242366	1	25.4	1 11/16-12	2	50	1 13/16	46	1.93	49.0	5.52	140.3	DG	DGF1-16	DGF1-16	DGF1-16	DGF1-16
S6-OFFX-1620	30700-1620	20242166	1	25.4	1 11/16-12	2	50	1 5/8	41	1.91	48.4	5.01	127.2	NS	Y			Y
DG-OFFX-2020	16700-2020	20242534	1 1/4	31.8	1 11/16-12	2	50	1 13/16	46	1.86	47.2	5.86	148.9	DG	DGF2-20	DGF2-20		DGF1-20
S6-OFFX-2020	30700-2020	20577104	1 1/4	31.8	1 11/16-12	2	50	1 5/8	41	2.20	56.0	6.55	166.3	NS	Y			Y
DG-OFFX-2424	16700-2424	20297682	1 1/2	38.1	1 7/8-12	2 3/8	60	2	50	2.05	52.0	6.28	159.5	DG	DGF2-24	DGF2-24		DGF1-24
S6-OFFX-2424	30700-2424	20297684	1 1/2	38.1	1 7/8-12	2 3/8	60	2	50	2.46	62.5	6.36	161.5	NS	Y			

Continued on next page

## O-Ring Face Seal (SAE J1453) ORS/ORFS Female | Swivel Continued

Descriptive #	Product #	SAP #	Hose Size ID		Thread Size (A)		Hex-1 Wrench Size		Hex-2 Wrench Size		Cut-Off (C)		Length (L)		Skive Type	SR13, ARC13	SR15, ARC15	S4SP	S4SH
			in.	mm	in.	mm	in.	mm	in.	mm	in.	mm	in.	mm					
SG-OFFX-0604	29700-0604	20821928	3/8	9.5	9/16-18	7/8	17	11/16	17	1.29	32.8	2.75	69.9	NS				Y	
SG-OFFX-0606	29700-0606	20758282	3/8	9.5	11/16-16	7/8	22	11/16	18	1.29	32.8	2.75	69.9	NS				Y	
SG-OFFX-0608	29700-0608	20731751	3/8	9.5	13/16-16	15/16	24	7/8	22	1.50	38.1	2.96	75.1	NS				Y	
SG-OFFX-0806	29700-0806	20821927	1/2	12.7	11/16-16	7/8	22	3/4	19	1.34	34.0	2.87	73.0	NS				Y	
SG-OFFX-0808	29700-0808	20731750	1/2	12.7	13/16-16	15/16	24	7/8	22	1.50	38.1	3.04	77.1	NS				Y	
SG-OFFX-0810	29700-0810	20731764	1/2	12.7	1-14	13/16	30	15/16	24	1.63	41.5	3.17	80.5	NS				Y	
SG-OFFX-0812	29700-0812	20731759	1/2	12.7	13/16-12	17/16	36	13/16	30	1.74	44.1	3.27	83.1	NS				Y	
SG-OFFX-1010	29700-1010	20821925	5/8	15.9	1-14	13/16	30	15/16	24	1.65	42.0	3.25	82.5	NS				Y	
SG-OFFX-1012	29700-1012	20821924	5/8	15.9	13/16-12	17/16	36	13/16	30	1.75	44.5	3.35	85.0	NS				Y	
SG-OFFX-1210	29700-1210	20821923	3/4	19.0	1-14	13/16	30	11/16	27	1.69	43.0	3.56	90.4	NS	Y	Y	Y	Y	
SG-OFFX-1212	29700-1212	20821922	3/4	19.0	13/16-12	17/16	36	13/16	30	1.78	45.2	3.65	92.7	NS	Y	Y	Y	Y	
SG-OFFX-1216	29700-1216	20821921	3/4	19.0	17/16-12	13/8	41	17/16	36	2.03	51.5	3.90	99.0	NS	Y	Y	Y	Y	
SG-OFFX-1612	29700-1612	20821920	1	25.4	13/16-12	17/16	36	11/4	32	1.95	49.4	4.23	107.4	NS	Y	Y	Y	Y	
SG-OFFX-1616	29700-1616	20821919	1	25.4	17/16-12	13/8	41	17/16	36	2.10	53.4	4.39	111.4	NS	Y	Y	Y	Y	
SG-OFFX-1620	29700-1620	20821918	1	25.4	111/16-12	2	50	13/8	41	1.99	50.5	4.27	108.5	NS	Y	Y	Y	Y	
SG-OFFX-2424	29700-2424	20757721	1 1/2	38.1	17/8-12	23/8	60	2	50	2.69	68.4	6.16	156.3	NS					Y

## O-Ring Face Seal (SAE J1453) ORS/ORFS Female | 45° Elbow | Swivel

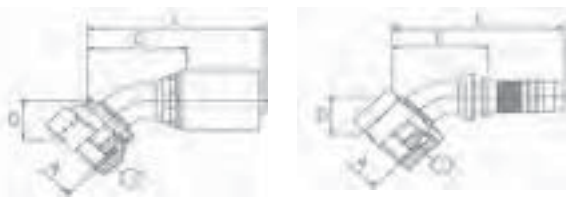

S=Skive  
NS=Non-Skive  
DG=Dual-Grip™

Descriptive #	Product #	SAP #	Hose Size ID		Thread Size (A)		Hex-1 Wrench Size		Drop (D)		Cut-Off (C)		Length (L)		Skive Type	SR13, ARC13	SR15, ARC15	S4SP	S4SH
			in.	mm	in.	mm	in.	mm	in.	mm	in.	mm							
DG-OFFX45-1212	16710-1212	20254300	3/4	19.0	13/16-12	17/16	36	1.02	26.0	3.07	78.0	5.89	149.5	DG	DGF1-12	DGF1-12	DGF1-12	DGF1-12	
S6-OFFX45-1212	30710-1212	20242251	3/4	19.0	13/16-12	17/16	36	1.02	26.0	3.19	81.0	5.73	145.5	NS	Y				Y
DG-OFFX45-1216	16710-1216	20254301	3/4	19.0	17/16-12	13/8	41	1.10	28.0	2.68	68.0	5.49	139.5	DG	DGF1-12	DGF1-12	DGF1-12	DGF1-12	
S6-OFFX45-1216	30710-1216	20242227	3/4	19.0	17/16-12	13/8	41	1.10	28.0	3.19	81.0	5.65	143.5	NS	Y				Y
DG-OFFX45-1616C	16710-1616	20242356	1	25.4	17/16-12	13/8	41	1.10	28.0	4.49	114.0	7.80	198.0	DG	DGF1-16	DGF1-16	DGF1-16	DGF1-16	
S6-OFFX45-1616	30710-1616	20242221	1	25.4	17/16-12	13/8	41	1.10	28.0	3.70	94.0	6.52	165.5	NS	Y				Y
DG-OFFX45-2020C	16710-2020	20242358	1 1/4	31.8	111/16-12	2	50	1.30	33.0	3.98	101.0	7.70	195.5	DG	DGF2-20	DGF2-20		DGF1-20	
S6-OFFX45-2020	30710-2020	20577105	1 1/4	31.8	111/16-12	2	50	1.44	36.5	4.33	110.0	8.37	212.5	NS	Y				Y
S6-OFFX45-2424	30710-2424	20424986	1 1/2	38.1	17/8-12	23/8	60	1.46	37.0	4.57	116.0	8.15	207.0	NS	Y				

C: Crimp Nut (see "Fitting Identification" in Appendix for details)  
DG: Part listed is Dual-Grip™ style (image is Uni-Crimp™ style)

Continued on next page



# O-Ring Face Seal (SAE J1453 ORS/ORFS)

Female | 45° Elbow | Swivel Continued

Descriptive #	Product #	SAP #	Hose Size ID		Thread Size (A)		Hex-1 Wrench Size		Drop (D)		Cut-Off (C)		Length (L)		Skive Type	SR13, ARC13	SR15, ARC15	S4SP	S4SH
			in.	mm	in.	mm	in.	mm	in.	mm	in.	mm	in.	mm					
SG-OFFX45-0606	29710-0606	20758286	3/8	9.5	11/16-16	7/8	22	0.43	11.0	1.85	47.0	3.31	84.0	NS			Y		
SG-OFFX45-0608	29710-0608	20821917	3/8	9.5	13/16-16	15/16	24	0.59	15.0	2.01	51.1	3.47	88.1	NS			Y		
SG-OFFX45-0808	29710-0808	20731758	1/2	12.7	13/16-16	15/16	24	0.63	16.0	1.85	47.0	3.42	86.9	NS			Y		
SG-OFFX45-0810	29710-0810	20758300	1/2	12.7	1-14	1 3/16	30	0.63	16.0	1.97	50.0	3.51	89.0	NS			Y		
SG-OFFX45-1010	29710-1010	20821916	5/8	15.9	1-14	1 3/16	30	0.63	16.0	1.65	42.0	3.86	98.0	NS			Y		
SG-OFFX45-1212	29710-1212	20821915	3/4	19.0	1 3/16-12	1 7/16	36	0.83	21.0	2.56	64.9	4.43	112.4	NS	Y	Y	Y	Y	
SG-OFFX45-1216	29710-1216	20821914	3/4	19.0	1 3/16-12	1 5/8	41	0.95	24.0	2.80	71.1	4.67	118.6	NS	Y	Y	Y	Y	
SG-OFFX45-1616	29710-1616	20821913	1	25.4	1 7/16-12	1 5/8	41	1.02	26.0	3.15	80.0	5.43	137.9	NS	Y	Y	Y	Y	
SG-OFFX45-1620	29710-1620	20758286	1	25.4	1 11/16-12	2	50	1.26	32.0	3.35	85.1	5.63	143.1	NS	Y	Y	Y	Y	

# O-Ring Face Seal (SAE J1453 ORS/ORFS)

Female | 90° Elbow | Swivel



Elbow Type  
 LT=Long Tube  
 ST=Short Tube

S=Skive  
 NS=Non-Skive  
 DG=Dual-Grip™

Descriptive #	Product #	SAP #	Hose Size ID		Thread Size (A)		Hex-1 Wrench Size	Elbow Type	Drop (D)		Cut-Off (C)		Length (L)		Skive Type	SR13, ARC13	SR15, ARC15	S4SP	S4SH
			in.	mm	in.	mm			in.	mm	in.	mm	in.	mm					
DG-OFFX90-1212	16715-1212	20254302	3/4	19.0	1 3/16-12	1 7/16	36		2.28	58.0	2.52	64.0	5.04	128.0	DG	DGF1-12	DGF1-12	DGF1-12	DGF1-12
S6-OFFX90-1212	30715-1212	20242238	3/4	19.0	1 3/16-12	1 7/16	36		2.28	58.0	2.68	68.0	4.84	123.0	NS	Y			Y
DG-OFFX90-1216	16715-1216	20254303	3/4	19.0	1 7/16-12	1 5/8	41		2.28	58.0	2.60	66.0	5.12	130.0	DG	DGF1-12	DGF1-12	DGF1-12	DGF1-12
S6-OFFX90S-1216	30725-1216	20242157	3/4	19.0	1 7/16-12	1 5/8	41	ST	2.28	58.0	2.76	70.0	4.92	125.0	NS	Y			Y
DG-OFFX90-1616 <sup>C</sup>	16715-1616	20242361	1	25.4	1 7/16-12	1 5/8	41		2.60	66.0	2.95	75.0	5.98	152.0	DG	DGF1-16	DGF1-16	DGF1-16	DGF1-16
S6-OFFX90-1616	30715-1616	20241700	1	25.4	1 7/16-12	1 5/8	41		2.60	66.0	3.15	80.0	5.67	144.0	NS	Y			Y
DG-OFFX90-2020 <sup>C</sup>	16715-2020	20242362	1 1/4	31.8	1 11/16-12	2	50		3.19	81.0	3.62	92.0	7.01	178.0	DG	DGF2-20	DGF2-20		DGF1-20
S6-OFFX90-2020	30715-2020	20577106	1 1/4	31.8	1 11/16-12	2	50		3.19	81.0	4.02	102.0	7.80	198.0	NS	Y			Y
DG-OFFX90-2424 <sup>C</sup>	16715-2024	20297683	1 1/2	38.1	1 7/8-12	2 3/8	60		3.31	84.0	3.90	99.0	7.52	191.0	DG	DGF2-24	DGF2-24		DGF1-24
S6-OFFX90-2424	30715-2424	20297685	1 1/2	38.1	1 7/8-12	2 3/8	60		3.80	96.5	5.12	130.0	8.39	213.0	NS	Y			

C: Crimp Nut (see "Fitting Identification" in Appendix for details)  
 DG: Part listed is Dual-Grip™ style (image is Uni-Crimp™ style)

Continued on next page

# O-Ring Face Seal (SAE J1453 ORS/ORFS)

Female | 90° Elbow | Swivel Continued

Descriptive #	Product #	SAP #	Hose Size ID		Thread Size (A)		Hex-1 Wrench Size		Elbow Type	Drop (D)		Cut-Off (C)		Length (L)		Skive Type	SR13, ARC13	SR15, ARC15	S4SP	S4SH
			in.	mm	in.	mm	in.	mm		in.	mm	in.	mm	in.	mm					
SG-OFFX90-0606	29715-0606	20731757	3/8	9.5	11/16-16	7/8	22			1.50	38.0	1.65	42.0	3.11	79.0	NS			Y	
SG-OFFX90L-0606	29720-0606	20731762	3/8	9.5	11/16-16	7/8	22	LT		2.126	54.0	1.65	42.0	3.11	79.0	NS			Y	
SG-OFFX90S-0606	29725-0606	20731760	3/8	9.5	11/16-16	7/8	22	ST		0.905	23.0	1.65	42.0	3.11	79.0	NS			Y	
SG-OFFX90-0608	29715-0608	20821911	3/8	9.5	13/16-16	15/16	24			1.614	41.0	1.73	44.0	3.189	81.0	NS			Y	
SG-OFFX90L-0608	29720-0608	20821904	3/8	9.5	13/16-16	15/16	24	LT		2.52	64.0	1.85	47.0	3.307	84.0	NS			Y	
SG-OFFX90S-0608	29725-0608	20821899	3/8	9.5	13/16-16	15/16	24	ST		1.142	29.0	1.65	42.0	3.11	79.0	NS			Y	
SG-OFFX90-0808	29715-0808	20731753	1/2	12.7	13/16-16	15/16	24			1.61	41.0	1.41	35.9	2.95	74.9	NS			Y	
SG-OFFX90L-0808	29720-0808	20821903	1/2	12.7	13/16-16	15/16	24	LT		2.52	64.0	1.53	38.9	3.07	77.9	NS			Y	
SG-OFFX90S-0808	29725-0808	20731756	1/2	12.7	13/16-16	15/16	24	ST		1.14	29.0	1.61	40.9	3.15	79.9	NS			Y	
SG-OFFX90-0810	29715-0810	20821910	1/2	12.7	1-14	1 1/16	30			1.85	47.0	1.89	48.0	3.43	87.0	NS			Y	
SG-OFFX90L-0810	29720-0810	20821902	1/2	12.7	1-14	1 1/16	30	LT		2.76	70.0	1.81	46.0	3.35	85.0	NS			Y	
SG-OFFX90S-0810	29725-0810	20821898	1/2	12.7	1-14	1 1/16	30	ST		1.26	32.0	1.81	46.0	3.38	85.9	NS			Y	
SG-OFFX90S-0812	29725-0812	20821897	1/2	12.7	1 3/16-12	1 1/16	36	ST		1.89	48.0	2.48	62.9	4.01	101.9	NS			Y	
SG-OFFX90-1010	29715-1010	20821909	5/8	15.9	1-14	1 1/16	30			1.85	47.0	2.17	55.0	3.76	95.5	NS			Y	
SG-OFFX90S-1010	29725-1010	20821896	5/8	15.9	1-14	1 1/16	30	ST		1.28	32.5	2.05	52.0	3.64	92.5	NS			Y	
SG-OFFX90S-1012	29725-1012	20821895	5/8	15.9	1 3/16-12	1 1/16	36	ST		1.89	48.0	2.48	62.9	4.07	103.4	NS			Y	
SG-OFFX90S-1210	29725-1210	20821894	3/4	19.0	1-14	1 1/16	30	ST		1.54	39.1	1.63	41.3	3.70	93.9	NS	Y	Y	Y	Y
SG-OFFX90-1212	29715-1212	20821908	3/4	19.0	1 3/16-12	1 1/16	36			2.28	58.0	2.52	63.9	4.39	111.4	NS	Y	Y	Y	Y
SG-OFFX90L-1212	29720-1212	20821901	3/4	19.0	1 3/16-12	1 1/16	36	LT		3.78	96.0	2.52	63.9	4.39	111.4	NS	Y	Y	Y	Y
SG-OFFX90S-1212	29725-1212	20821893	3/4	19.0	1 3/16-12	1 1/16	36	ST		1.89	48.0	2.48	62.9	4.35	110.4	NS	Y	Y	Y	Y
SG-OFFX90-1216	29715-1216	20821907	3/4	19.0	1 7/16-12	1 5/8	41			2.80	71.1	2.68	68.0	4.55	115.5	NS	Y	Y	Y	Y
SG-OFFX90S-1216	29725-1216	20821892	3/4	19.0	1 7/16-12	1 5/8	41	ST		2.21	56.0	2.68	68.0	4.55	115.5	NS	Y	Y	Y	Y
SG-OFFX90-1616	29715-1616	20821906	1	25.4	1 7/16-12	1 5/8	41			2.80	71.0	3.13	79.6	5.42	137.5	NS	Y	Y	Y	Y
SG-OFFX90L-1616	29720-1616	20821900	1	25.4	1 7/16-12	1 5/8	41	LT		4.49	114.0	3.13	79.5	5.42	137.5	NS	Y	Y	Y	Y
SG-OFFX90S-1616	29725-1616	20821891	1	25.4	1 7/16-12	1 5/8	41	ST		2.26	57.5	3.13	79.6	5.42	137.5	NS	Y	Y	Y	Y
SG-OFFX90-1620	29715-1620	20821905	1	25.4	1 7/16-12	2	50			3.07	78.0	3.27	83.0	5.55	141.0	NS	Y	Y	Y	Y
SG-OFFX90S-1620	29725-1620	20821890	1	25.4	1 7/16-12	2	50	ST		2.52	64.0	3.27	83.0	5.55	141.0	NS	Y	Y	Y	Y

# O-Ring Face Seal (SAE J1453 ORS/ORFS)

Male

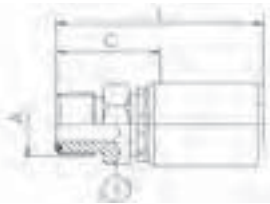

S=Skive  
NS=Non-Skive  
DG=Dual-Grip™

Descriptive #	Product #	SAP #	Hose Size ID		Thread Size (A)		Hex-1 Wrench Size		Cut-Off (C)		Length (L)		Skive Type	SR13, ARC13	SR15, ARC15	S4SP	S4SH
			in.	mm	in.	mm	in.	mm	in.	mm							
S6-OFM-1212	30730-1212	20424990	3/4	19.0	1 3/16-12	1 1/4	32		1.42	36.0	3.62	92.0	NS	Y			Y
S6-OFM-1616	30730-1616	20424991	1	25.4	1 7/16-12	1 1/2	38		1.57	40.0	4.09	104.0	NS	Y			Y
S6-OFM-2020	30730-2020	20424992	1 1/4	31.8	1 11/16-12	1 3/16	46		1.75	44.5	5.51	140.0	NS	Y			Y
S6-OFM-2424	30730-2424	20424993	1 1/2	38.1	2-12	2 3/16	55		1.91	48.5	5.18	131.5	NS	Y			

Continued on next page

# O-Ring Face Seal (SAE J1453 ORS/ORFS)

Male Continued

Descriptive #	Product #	SAP #	Hose Size ID		Thread Size (A)		Hex-1 Wrench Size		Cut-Off (C)		Length (L)		Skive Type	SR13, ARC13	SR15, ARC15	S4SP	S4SH
			in.	mm	in.	mm	in.	mm	in.	mm	in.	mm					
SG-OFM-0606	29730-0606	20758281	3/8	9.5	11/16-16	3/4	19	1.15	29.3	2.61	66.3	NS			Y		
SG-OFM-0608	29730-0608	20821889	3/8	9.5	13/16-16	7/8	22	1.15	29.1	2.60	66.1	NS			Y		
SG-OFM-0808	29730-0808	20758297	1/2	12.7	13/16-16	7/8	22	1.27	32.3	2.81	71.3	NS			Y		
SG-OFM-0810	29730-0810	20821888	1/2	12.7	13/16-16	1 1/16	27	1.29	32.7	2.83	71.8	NS			Y		
SG-OFM-0812	29730-0812	20821887	1/2	12.7	13/16-16	1 1/4	32	1.42	36.0	2.95	75.0	NS			Y		
SG-OFM-1212	29730-1212	20821886	3/4	19.0	1 3/16-12	1 1/4	32	1.48	37.5	3.35	85.0	NS	Y	Y	Y	Y	
SG-OFM-1216	29730-1216	20821885	3/4	19.0	1 7/16-12	1 1/2	38	1.58	40.1	3.45	87.6	NS	Y	Y	Y	Y	
SG-OFM-1616	29730-1616	20821884	1	25.4	1 7/16-12	1 1/2	38	1.64	41.6	3.92	99.6	NS	Y	Y	Y	Y	

# O-Ring Boss Straight Thread (SAE J514)

Male

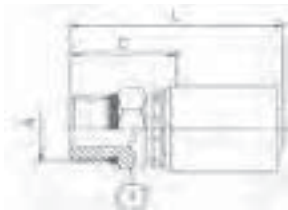

S=Skive  
NS=Non-Skive  
DG=Dual-Grip™

Descriptive #	Product #	SAP #	Hose Size ID		Thread Size (A)		Hex-1 Wrench Size		Cut-Off (C)		Length (L)		Skive Type	SR13, ARC13	SR15, ARC15	S4SP	S4SH
			in.	mm	in.	mm	in.	mm	in.	mm	in.	mm					
SG-OBM-0606	29670-0606	20821946	3/8	9.5	9/16-18	3/4	19	1.03	26.1	2.48	63.1	NS			Y		
SG-OBM-0608	29670-0608	20821945	3/8	9.5	3/4-16	7/8	22	1.09	27.6	2.54	64.6	NS			Y		
SG-OBM-0610	29670-0610	20821944	3/8	9.5	7/8-14	1 1/16	27	1.18	29.9	2.64	67.0	NS			Y		
SG-OBM-0808	29670-0808	20821943	1/2	12.7	3/4-16	7/8	22	1.09	27.6	2.62	66.6	NS			Y		
SG-OBM-0810	29670-0810	20821942	1/2	12.7	3/4-16	1 1/16	27	1.18	29.9	2.72	69.0	NS			Y		
SG-OBM-0812	29670-0812	20821941	1/2	12.7	7/8-14	1 1/4	32	1.34	34.1	2.88	73.1	NS			Y		
SG-OBM-1210	29670-1210	20821940	3/4	19.1	1 1/16-12	1 1/16	27	1.24	31.4	3.11	78.9	NS	Y	Y	Y	Y	
SG-OBM-1212	29670-1212	20821939	3/4	19.1	3/4-16	1 1/4	32	1.40	35.6	3.27	83.1	NS	Y	Y	Y	Y	
SG-OBM-1216	29670-1216	20821938	3/4	19.1	7/8-14	1 1/2	38	1.48	37.6	3.35	85.1	NS	Y	Y	Y	Y	
SG-OBM-1616	29670-1616	20821937	1	25.4	1 1/16-12	1 1/2	38	1.54	39.1	3.83	97.2	NS	Y	Y	Y	Y	

# Code 61 Flange (SAE J518)



S=Skive  
NS=Non-Skive  
DG=Dual-Grip™

Descriptive #	Product #	SAP #	Hose Size ID		Flange Size	Flange Diameter (A)		Cut-Off (C)		Length (L)		Skive Type	SR13, ARC13	SR15, ARC15	S4SP	S4SH
			in.	mm		in.	mm	in.	mm	in.	mm					
DG-FL-1212	16320-1212	20242452	3/4	19.0	3/4	1.50	38.1	1.34	34.0	4.09	104.0	DG	DGF1-12	DGF1-12	DGF1-12	DGF1-12
S6-FL-1212	30320-1212	20307981	3/4	19.0	3/4	1.50	38.1	1.71	43.5	3.88	98.5	NS	Y			Y
DG-FL-1216	16320-1216	20242382	3/4	19.0	1	1.75	44.5	1.65	42.0	4.41	112.0	DG	DGF1-12	DGF1-12	DGF1-12	DGF1-12
DG-FL-1616	16320-1616	20242619	1	25.4	1	1.75	44.5	1.61	41.0	4.94	125.5	DG	DGF1-16	DGF1-16	DGF1-16	DGF1-16
S6-FL-1616	30320-1616	20307982	1	25.4	1	1.75	44.5	2.11	53.5	4.63	117.5	NS	Y			Y
DG-FL-1620	16320-1620	20242416	1	25.4	1¼	2.00	50.8	1.71	43.5	5.04	128.0	DG	DGF1-16	DGF1-16	DGF1-16	DGF1-16
S6-FL-1624	30320-1624	20293317	1	25.4	1½	2.37	60.3	2.32	59.0	4.84	123.0	NS	Y			Y
DG-FL-2020	16320-2020	20242451	1¼	31.8	1¼	2.00	50.8	1.67	42.3	5.49	139.5	DG	DGF2-20	DGF2-20		DGF1-20
S6-FL-2020	30320-2020	20577095	1¼	31.8	1¼	2.00	50.8	2.30	58.5	6.06	154.0	NS	Y			Y
DG-FL-2024	16320-2024	20242299	1¼	31.8	1½	2.37	60.3	1.78	45.3	5.61	142.5	DG	DGF2-20	DGF2-20		DGF1-20
DG-FL-2424	16320-2424	20242554	1½	38.1	1½	2.37	60.3	1.77	45.0	5.81	147.5	DG	DGF2-24	DGF2-24		DGF1-24
S6-FL-2424	30320-2424	20307984	1½	38.1	1½	2.37	60.3	2.50	63.5	5.77	146.5	NS	Y			
DG-FL-2432	16320-2432	20242298	1½	38.1	2	2.81	71.4	2.22	56.5	6.26	159.0	DG	DGF2-24	DGF2-24		DGF1-24
S6-FL-3224	30320-3224	20788102	2	50.8	1½	2.37	60.3	2.992	76.0	6.92	175.8	NS	Y			
DG-FL-3232	16320-3232	20242526	2	50.8	2	2.81	71.4	2.17	55.0	6.54	166.0	DG	DGF2-32			DGF1-32
S6-FL-3232	30320-3232	20307985	2	50.8	2	2.81	71.4	2.76	70.1	6.688	169.9	NS	Y			
S6-FL-3240	30320-3240	20788103	2	50.8	2½	3.31	84.1	2.612	66.3	6.54	166.1	NS	Y			

Descriptive #	Product #	SAP #	Hose Size ID		Flange Size	Flange Diameter (A)		Cut-Off (C)		Length (L)		Skive Type	SR13, ARC13	SR15, ARC15	S4SP	S4SH
			in.	mm		in.	mm	in.	mm	in.	mm					
SG-FL-0808	29320-0808	20822104	1/2	12.7	1/2	1.19	30.2	1.61	40.9	3.15	79.9	NS		Y	Y	
SG-FL-0812	29320-0812	20822131	1/2	12.7	3/4	1.50	38.1	1.65	41.9	3.19	80.9	NS		Y	Y	
SG-FL-1012	29320-1012	20822102	5/8	15.9	3/4	1.50	38.1	1.71	43.3	3.30	83.8	NS			Y	
SG-FL-1212	29320-1212	20822098	3/4	19.0	3/4	1.50	38.1	1.75	44.3	3.62	91.8	NS	Y	Y	Y	Y
SG-FL-1216	29320-1216	20822097	3/4	19.0	1	1.75	44.5	1.99	50.5	3.86	98.0	NS	Y	Y	Y	Y
SG-FL-1220	29320-1220	20822096	3/4	19.0	1¼	2.00	50.8	2.09	53.0	3.96	100.6	NS	Y	Y	Y	Y
SG-FL-1616	29320-1616	20822094	1	25.4	1	1.75	44.5	2.09	53.1	4.37	111.1	NS	Y	Y	Y	Y
SG-FL-1620	29320-1620	20822093	1	25.4	1¼	2.00	50.8	2.12	53.9	4.40	111.8	NS	Y	Y	Y	Y
SG-FL-1624	29320-1624	20822092	1	25.4	1½	2.37	60.3	2.32	58.9	4.60	116.8	NS	Y	Y	Y	Y
SG-FL-2424	29320-2424	20757499	1½	38.1	1½	2.38	60.3	2.91	73.8	6.45	163.9	NS				Y
SG-FL-3232	29320-3232	20833306	2	50.8	2	2.81	71.4	2.907	73.8	6.451	163.9	NS				Y

# Code 61 Flange (SAE J518)

22.5° Elbow

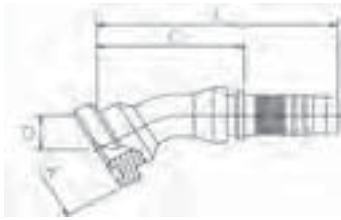

S=Skive  
NS=Non-Skive  
DG=Dual-Grip™v

Descriptive #	Product #	SAP #	Hose Size ID		Flange Size	Flange Diameter (A)		Drop (D)		Cut-Off (C)		Length (L)		Skive Type	SR13, ARC13	SR15, ARC15	S4SP	S4SH
			in.	mm		in.	mm	in.	mm	in.	mm	in.	mm					
S6-FL22-3232	30330-3232	20788100	2	50.8	2	2.81	71.4	0.866	22.0	5.709	145.0	9.637	244.8	NS	Y			

Descriptive #	Product #	SAP #	Hose Size ID		Flange Size	Flange Diameter (A)		Drop (D)		Cut-Off (C)		Length (L)		Skive Type	SR13, ARC13	SR15, ARC15	S4SP	S4SH
			in.	mm		in.	mm	in.	mm	in.	mm	in.	mm					
SG-FL22-0808	29330-0808	20822091	1/2	12.7	1/2	1.19	30.2	0.35	9.0	2.32	58.9	3.86	97.9	NS			Y	
SG-FL22-1212	29330-1212	20822090	3/4	19.0	3/4	1.50	38.1	0.55	14.0	3.33	84.5	5.20	132.0	NS	Y	Y	Y	Y
SG-FL22-1216	29330-1216	20822089	3/4	19.0	1	1.75	44.5	0.55	14.0	3.39	86.1	5.26	133.6	NS	Y	Y	Y	Y
SG-FL22-1616	29330-1616	20822088	1	25.4	1	1.75	44.5	0.55	14.0	4.22	107.1	6.50	165.1	NS	Y	Y	Y	Y
SG-FL22-1620	29330-1620	20822087	1	25.4	1 1/4	2.00	50.8	0.59	15.0	3.62	91.9	5.90	149.9	NS	Y	Y	Y	Y

# Code 61 Flange (SAE J518)

30° Elbow

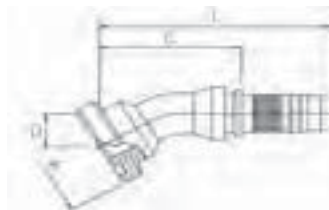
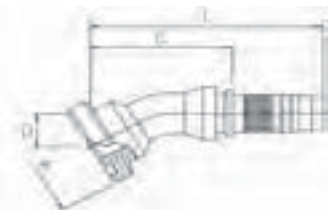

S=Skive  
NS=Non-Skive  
DG=Dual-Grip™

Descriptive #	Product #	SAP #	Hose Size ID		Flange Size	Flange Diameter (A)		Drop (D)		Cut-Off (C)		Length (L)		Skive Type	SR13, ARC13	SR15, ARC15	S4SP	S4SH
			in.	mm		in.	mm	in.	mm	in.	mm	in.	mm					
S6-FL30-1624	30335-1624	20293318	1	25.4	1 1/2	2.37	60.3	1.06	27.0	4.21	107.0	6.73	171.0	NS	Y			Y
DG-FL30-3232	16335-3232	20297539	2	50.8	2	2.81	71.4	1.28	32.5	5.87	149.0	9.69	246.0	DG	DGF2-32			DGF1-32
S6-FL30-3232	30335-3232	20788101	2	50.8	2	2.81	71.4	1.26	32.0	5.71	145.0	9.64	244.8	NS	Y			

Descriptive #	Product #	SAP #	Hose Size ID		Flange Size	Flange Diameter (A)		Drop (D)		Cut-Off (C)		Length (L)		Skive Type	SR13, ARC13	SR15, ARC15	S4SP	S4SH
			in.	mm		in.	mm	in.	mm	in.	mm	in.	mm					
SG-FL30-1212	29335-1212	20822086	3/4	19.0	3/4	2.37	60.3	0.69	17.5	3.23	81.9	5.14	130.5	NS	Y	Y	Y	Y
SG-FL30-1216	29335-1216	20822085	3/4	19.0	1	1.75	44.5	0.75	19.0	3.31	84.1	5.18	131.6	NS	Y	Y	Y	Y
SG-FL30-1616	29335-1616	20822084	1	25.4	1	1.75	44.5	0.75	19.0	4.15	105.4	6.43	163.4	NS	Y	Y	Y	Y
SG-FL30-1620	29335-1620	20822083	1	25.4	1 1/4	1.25	2.0	0.87	22.0	3.54	89.9	5.82	147.9	NS	Y	Y	Y	Y
SG-FL30-1624	29335-1624	20822082	1	25.4	1 1/2	2.37	60.3	1.06	27.0	4.21	107.0	6.50	165.0	NS	Y	Y	Y	Y

# Code 61 Flange (SAE J518)

45° Elbow

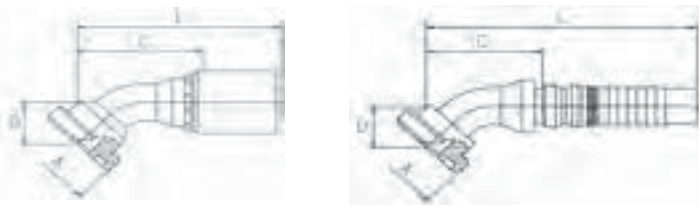

S=Skive  
NS=Non-Skive  
DG=Dual-Grip™

Descriptive #	Product #	SAP #	Hose Size ID		Flange Size	Flange Diameter (A)		Drop (D)		Cut-Off (C)		Length (L)		Skive Type	SR13, ARC13	SR15, ARC15	S4SP	S4SH
			in.	mm		in.	mm	in.	mm	in.	mm	in.	mm					
DG-FL45-1212	16340-1212	20242450	3/4	19.0	3/4	1.50	38.1	0.98	25.0	2.72	69.0	5.24	133.0	DG	DGF1-12	DGF1-12	DGF1-12	DGF1-12
S6-FL45-1212	30340-1212	20424972	3/4	19.0	3/4	1.50	38.1	1.10	28.0	2.80	71.0	4.96	126.0	NS	Y			Y
DG-FL45-1616	16340-1616	20242558	1	25.4	1	1.75	44.5	1.38	35.0	3.27	83.0	6.30	160.0	DG	DGF1-16	DGF1-16	DGF1-16	DGF1-16
S6-FL45-1616	30340-1616	20307986	1	25.4	1	1.75	44.5	1.38	35.0	3.46	88.0	5.98	152.0	NS	Y			Y
DG-FL45-1620	16340-1620	20242291	1	25.4	1 1/4	2.00	50.8	1.18	30.0	3.78	96.0	6.77	172.0	DG	DGF1-16	DGF1-16	DGF1-16	DGF1-16
DG-FL45-2020	16340-2020	20242414	1 1/4	31.8	1 1/4	2.00	50.8	1.28	32.5	3.98	101.0	7.40	188.0	DG	DGF2-20	DGF2-20		DGF1-20
S6-FL45-2020	30340-2020	20568985	1 1/4	31.8	1 1/4	2.00	50.8	1.52	38.5	4.09	104.0	7.87	200.0	NS	Y			Y
DG-FL45-2024	16340-2024	20242292	1 1/4	31.8	1 1/2	2.37	60.3	1.57	40.0	3.66	93.0	7.09	180.0	DG	DGF2-20	DGF2-20		DGF1-20
DG-FL45-2424	16340-2424	20242449	1 1/2	38.1	1 1/2	2.37	60.3	1.69	43.0	4.09	104.0	7.68	195.0	DG	DGF2-24	DGF2-24		DGF1-24
S6-FL45-2424	30340-2424	20307988	1 1/2	38.1	1 1/2	2.37	60.3	1.69	43.0	4.37	111.0	7.64	194.0	NS	Y			Y
DG-FL45-3232	16340-3232	20242294	2	50.8	2	2.81	71.4	2.13	54.0	5.43	138.0	9.25	235.0	DG	DGF2-32			DGF1-32
S6-FL45-3232	30340-3232	20788104	2	50.8	2	2.81	71.4	2.21	56.0	6.10	155.0	10.03	254.8	NS	Y			

Descriptive #	Product #	SAP #	Hose Size ID		Flange Size	Flange Diameter (A)		Drop (D)		Cut-Off (C)		Length (L)		Skive Type	SR13, ARC13	SR15, ARC15	S4SP	S4SH
			in.	mm		in.	mm	in.	mm	in.	mm	in.	mm					
SG-FL45-0808	29340-0808	20822081	3/4	19.0	3/4	1.50	38.1	0.98	25.0	2.72	69.0	5.24	133.0	NS			Y	
SG-FL45-0812	29340-0812	20822080	3/4	19.0	3/4	1.50	38.1	1.10	28.0	2.80	71.0	4.96	126.0	NS			Y	
SG-FL45-1012	29340-1012	20822079	1	25.4	1	1.75	44.5	1.38	35.0	3.27	83.0	6.30	160.0	NS			Y	
SG-FL45-1212	29340-1212	20822078	1	25.4	1	1.75	44.5	1.38	35.0	3.46	88.0	5.98	152.0	NS	Y	Y	Y	Y
SG-FL45-1216	29340-1216	20822077	1	25.4	1 1/4	2.00	50.8	1.18	30.0	3.78	96.0	6.77	172.0	NS	Y	Y	Y	Y
SG-FL45-1616	29340-1616	20822076	1 1/4	31.8	1 1/4	2.00	50.8	1.28	32.5	3.98	101.0	7.40	188.0	NS	Y	Y	Y	Y
SG-FL45-1620	29340-1620	20822075	1 1/4	31.8	1 1/4	2.00	50.8	1.52	38.5	4.09	104.0	7.87	200.0	NS	Y	Y	Y	Y
SG-FL45-2424	29340-2424	20757724	1 1/2	38.1	1 1/2	2.38	60.3		Contact Continental ContiTech				NS					Y

## Code 61 Flange (SAE J518)

60° Elbow

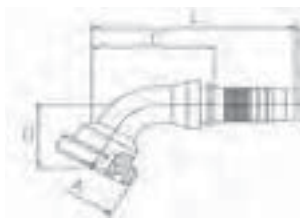

S=Skive  
NS=Non-Skive  
DG=Dual-Grip™

Descriptive #	Product #	SAP #	Hose Size ID		Flange Size	Flange Diameter (A)		Drop (D)		Cut-Off (C)		Length (L)		Skive Type	SR13, ARC13	SR15, ARC15	S4SP	S4SH
			in.	mm		in.	mm	in.	mm	in.	mm	in.	mm					
S6-FL60-3232	30345-3232	20788105	2	50.8	2	2.81	71.4	3.268	83.0	5.709	145.0	9.637	244.8	NS	Y			

Descriptive #	Product #	SAP #	Hose Size ID		Flange Size	Flange Diameter (A)		Drop (D)		Cut-Off (C)		Length (L)		Skive Type	SR13, ARC13	SR15, ARC15	S4SP	S4SH
			in.	mm		in.	mm	in.	mm	in.	mm	in.	mm					
SG-FL60-1212	29345-1212	20822074	3/4	19.0	3/4	1.50	38.1	1.46	37.1	3.47	88.0	5.34	135.5	NS	Y	Y	Y	Y
SG-FL60-1216	29345-1216	20822073	3/4	19.0	1	1.75	44.5	1.73	44.0	3.46	87.9	5.33	135.4	NS	Y	Y	Y	Y
SG-FL60-1616	29345-1616	20822072	1	25.4	1	1.75	44.5	1.73	44.0	4.15	105.4	6.43	163.4	NS	Y	Y	Y	Y
SG-FL60-1620	29345-1620	20822071	1	25.4	1 1/4	2.00	50.8	2.17	55.0	4.20	106.7	6.48	164.7	NS	Y	Y	Y	Y

## Code 61 Flange (SAE J518)

67° Elbow



S=Skive  
NS=Non-Skive  
DG=Dual-Grip™

Descriptive #	Product #	SAP #	Hose Size ID		Flange Size	Flange Diameter (A)		Drop (D)		Cut-Off (C)		Length (L)		Skive Type	SR13, ARC13	SR15, ARC15	S4SP	S4SH
			in.	mm		in.	mm	in.	mm	in.	mm	in.	mm					
S6-FL67-1212	30347-1212	20293319	3/4	19.0	3/4	1.50	38.1	1.79	45.5	3.19	81.0	5.35	136.0	NS	Y			Y
S6-FL67-1616	30347-1616	20293320	1	25.4	1	1.75	44.5	1.89	48.0	3.56	90.5	6.08	154.5	NS	Y			Y
S6-FL67-2020	30347-2020	20577097	1 1/4	31.8	1 1/4	2.00	50.8	2.34	59.5	5.12	130.0	8.11	206.0	NS	Y			Y
S6-FL67-3232	30347-3232	20293322	2	50.8	2	2.81	71.4	3.819	97.0	6.30	160.0	10.23	259.8	NS	Y			

Descriptive #	Product #	SAP #	Hose Size ID		Flange Size	Flange Diameter (A)		Drop (D)		Cut-Off (C)		Length (L)		Skive Type	SR13, ARC13	SR15, ARC15	S4SP	S4SH
			in.	mm		in.	mm	in.	mm	in.	mm	in.	mm					
SG-FL67-1212	29347-1212	20822070	3/4	19.0	3/4	1.50	38.1	1.65	42.0	3.17	80.4	5.04	127.9	NS	Y	Y	Y	Y
SG-FL67-1216	29347-1216	20822069	3/4	19.0	1	1.75	44.5	2.01	51.0	3.46	87.9	5.33	135.4	NS	Y	Y	Y	Y
SG-FL67-1616	29347-1616	20822068	1	25.4	1	1.75	44.5	2.40	61.0	3.84	97.6	6.13	155.6	NS	Y	Y	Y	Y
SG-FL67-1620	29347-1620	20822067	1	25.4	1 1/4	2.00	50.8	2.52	64.0	3.88	98.6	6.16	156.5	NS	Y	Y	Y	Y

# Code 61 Flange (SAE J518)

90° Elbow

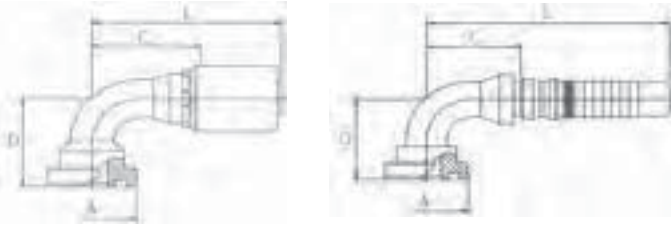

S=Skive  
NS=Non-Skive  
DG=Dual-Grip™

Descriptive #	Product #	SAP #	Hose Size ID		Flange Size	Flange Diameter (A)		Drop (D)		Cut-Off (C)		Length (L)		Skive Type	SR13, ARC13	SR15, ARC15	S4SP	S4SH
			in.	mm		in.	mm	in.	mm	in.	mm	in.	mm					
DG-FL90-1212	16350-1212	20242486	3/4	19.0	3/4	1.50	38.1	2.17	55.0	2.48	63.0	5.00	127.0	DG	DGF1-12	DGF1-12	DGF1-12	DGF1-12
S6-FL90-1212	30350-1212	20307989	3/4	19.0	3/4	1.50	38.1	2.28	58.0	2.56	65.0	4.72	120.0	NS	Y			Y
DG-FL90-1216	16350-1216	20242297	3/4	19.0	1	1.75	44.5	2.32	59.0	2.52	64.0	5.04	128.0	DG	DGF1-12	DGF1-12	DGF1-12	DGF1-12
S6-FL90-1612	30350-1612	20293323	1	25.4	3/4	1.50	38.1	2.17	55.0	2.72	69.0	5.24	133.0	NS	Y			Y
DG-FL90-1616	16350-1616	20242603	1	25.4	1	1.75	44.5	2.52	64.0	2.83	72.0	5.87	149.0	DG	DGF1-16	DGF1-16	DGF1-16	DGF1-16
S6-FL90-1616	30350-1616	20308020	1	25.4	1	1.75	44.5	2.52	64.0	3.07	78.0	5.59	142.0	NS	Y			Y
DG-FL90-1620	16350-1620	20242295	1	25.4	1 1/4	2.00	50.8	2.72	69.0	2.76	70.0	5.79	147.0	DG	DGF1-16	DGF1-16	DGF1-16	DGF1-16
S6-FL90-1624	30350-1624	20293324	1	25.4	1 1/2	2.37	60.3	2.95	75.0	3.74	95.0	6.26	159.0	NS	Y			Y
DG-FL90-2020	16350-2020	20242415	1 1/4	31.8	1 1/4	2.00	50.8	3.19	81.0	3.39	86.0	6.81	173.0	DG	DGF2-20	DGF2-20		DGF1-20
S6-FL90-2020	30350-2020	20577098	1 1/4	31.8	1 1/4	2.00	50.8	3.19	81.0	3.62	92.0	7.36	187.0	NS	Y			Y
DG-FL90-2024	16350-2024	20242296	1 1/4	31.8	1 1/2	2.37	60.3	3.35	85.0	3.19	81.0	6.61	168.0	DG	DGF2-20	DGF2-20		DGF1-20
DG-FL90-2424	16350-2424	20242524	1 1/2	38.1	1 1/2	2.37	60.3	3.66	93.0	3.78	96.0	7.36	187.0	DG	DGF2-24	DGF2-24		DGF1-24
S6-FL90-2424	30350-2424	20308022	1 1/2	38.1	1 1/2	2.37	60.3	3.66	93.0	4.06	103.0	7.32	186.0	NS	Y			
DG-FL90-3232	16350-3232	20242525	2	50.8	2	2.81	71.4	5.12	130.0	5.28	134.0	9.09	231.0	DG	DGF2-32			DGF1-32
S6-FL90-3232	30350-3232	20308023	2	50.8	2	2.81	71.4	5.433	138.0	5.71	145.0	9.639	168.6	NS	Y			

Descriptive #	Product #	SAP #	Hose Size ID		Flange Size	Flange Diameter (A)		Drop (D)		Cut-Off (C)		Length (L)		Skive Type	SR13, ARC13	SR15, ARC15	S4SP	S4SH
			in.	mm		in.	mm	in.	mm	in.	mm	in.	mm					
SG-FL90-0808	29350-0808	20758301	1/2	12.7	1/2	1.19	30.2	1.634	41.5	1.89	48.0	3.43	87.0	NS			Y	
SG-FL90-0812	29350-0812	20822066	1/2	12.7	3/4	1.50	38.1	2.284	55.0	1.89	63.0	3.43	127.0	NS			Y	
SG-FL90-1212	29350-1212	20822065	3/4	19.0	3/4	1.50	38.1	2.284	58.0	2.36	65.0	4.23	112.5	NS	Y	Y	Y	Y
SG-FL90-1216	29350-1216	20822064	3/4	19.0	1	1.75	44.5	2.756	59.0	2.60	64.0	2.60	128.0	NS	Y	Y	Y	Y
SG-FL90L-1216	29352-1216	20822059	3/4	19.0	1	1.75	38.1	6.063	55.0	2.60	69.0	4.47	133.0	NS	Y	Y	Y	Y
SG-FL90-1612	29350-1612	20822063	1	25.4	3/4	1.50	38.1	2.284	58.0	2.63	66.7	4.908	124.7	NS	Y	Y	Y	Y
SG-FL90-1616	29350-1616	20822062	1	25.4	1	1.75	44.5	2.76	64.0	2.97	72.0	5.25	149.0	NS	Y	Y	Y	Y
SG-FL90L-1616	29352-1616	20822058	1	25.4	1	1.75	44.5	6.063	64.0	3.97	78.0	6.25	142.0	NS	Y	Y	Y	Y
SG-FL90-1620	29350-1620	20822061	1	25.4	1 1/4	2.00	50.8	3.543	90.0	3.07	78.0	5.353	136.0	NS	Y	Y	Y	Y
SG-FL90-1624	29350-1624	20822060	1	25.4	1 1/2	2.38	44.5	2.953	64.0	3.74	78.0	6.023	142.0	NS	Y	Y	Y	Y
SG-FL90-2424	29350-2424	20757723	1 1/2	38.1	1 1/2	2.38	44.5	Contact Continental ContiTech						NS				Y



## Code 61 Flange (SAE J518)

110° Elbow

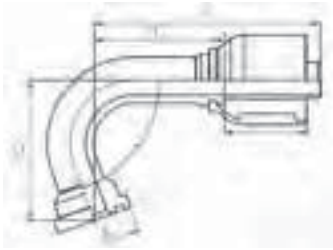

S=Skive  
NS=Non-Skive  
DG=Dual-Grip™

Descriptive #	Product #	SAP #	Hose Size ID		Flange Size		Flange Diameter (A)		Drop (D)		Cut-Off (C)		Length (L)		Skive Type	SR13, ARC13	SR15, ARC15	S4SP	S4SH
			in.	mm	in.	mm	in.	mm	in.	mm	in.	mm	in.	mm					
SG-FL110-1212	29354-1212	20822101	3/4	19.0	3/4	1.50	38.1	2.76	70.1	2.52	63.9	4.39	111.4	NS	Y	Y	Y	Y	
SG-FL110-1216	29354-1216	20822100	3/4	19.0	1	1.75	44.5	2.91	73.9	2.25	57.2	4.12	104.6	NS	Y	Y	Y	Y	
SG-FL110-1616	29354-1616	20822099	1	25.4	1	1.75	44.5	3.11	79.0	3.81	96.8	6.09	154.8	NS	Y	Y	Y	Y	

## Code 61 Flange (SAE J518)

135° Elbow

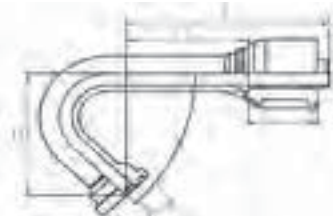

S=Skive  
NS=Non-Skive  
DG=Dual-Grip™

Descriptive #	Product #	SAP #	Hose Size ID		Flange Size		Flange Diameter (A)		Drop (D)		Cut-Off (C)		Length (L)		Skive Type	SR13, ARC13	SR15, ARC15	S4SP	S4SH
			in.	mm	in.	mm	in.	mm	in.	mm	in.	mm	in.	mm					
SG-FL135-1212	29355-1212	20822095	3/4	19.0	3/4	1.50	38.1	3.15	80.0	2.83	71.8	4.70	119.3	NS	Y	Y	Y	Y	

# Code 62 Flange (SAE J518)



S=Skive  
NS=Non-Skive  
DG=Dual-Grip™

Descriptive #	Product #	SAP #	Hose Size ID		Flange Size	Flange Diameter (A)		Cut-Off (C)		Length (L)		Skive Type	SR13, ARC13	SR15, ARC15	S4SP	S4SH
			in.	mm		in.	mm	in.	mm	in.	mm					
DG-FH-1212	16300-1212	20254304	3/4	190	3/4	1.63	41.3	1.73	44.0	4.49	114.0	DG	DGF1-12	DGF1-12	DGF1-12	DGF1-12
S6-FH-1212	30300-1212	20241742	3/4	190	3/4	1.63	41.3	2.11	53.5	4.27	108.5	NS	Y			Y
DG-FH-1216	16300-1216	20254305	3/4	190	1	1.87	47.6	1.85	47.0	4.61	117.0	DG	DGF1-12	DGF1-12	DGF1-12	DGF1-12
S6-FH-1216	30300-1216	20241746	3/4	190	1	1.87	47.6	2.22	56.5	4.39	111.5	NS	Y			Y
S6-FH-1612	30300-1612	20293325	1	25.4	3/4	1.63	41.3	2.30	58.5	4.82	122.5	NS	Y			Y
DG-FH-1616	16300-1616	20242528	1	25.4	1	1.87	47.6	1.81	46.0	5.14	130.5	DG	DGF1-16	DGF1-16	DGF1-16	DGF1-16
S6-FH-1616	30300-1616	20241219	1	25.4	1	1.87	47.6	2.30	58.5	4.82	122.5	NS	Y			Y
DG-FH-1620	16300-1620	20242307	1	25.4	1/4	2.13	54.0	2.09	53.0	5.41	137.5	DG	DGF1-16	DGF1-16	DGF1-16	DGF1-16
S6-FH-1620	30300-1620	20241736	1	25.4	1/4	2.13	54.0	2.58	65.5	5.10	129.5	NS	Y			Y
DG-FH-2016	16300-2016	20242797	1/4	31.8	1	1.87	47.6	2.75	69.8	6.57	167.0	DG	DGF2-20	DGF2-20		DGF1-20
DG-FH-2020	16300-2020	20242309	1/4	31.8	1/4	2.13	54.0	2.04	51.8	5.87	149.0	DG	DGF2-20	DGF2-20		DGF1-20
S6-FH-2020	30300-2020	20577082	1/4	31.8	1/4	2.13	54.0	2.52	64.0	6.28	159.5	NS	Y			Y
DG-FH-2024	16300-2024	20254306	1/4	31.8	1/2	2.50	63.5	2.28	57.8	6.10	155.0	DG	DGF2-20	DGF2-20		DGF1-20
S6-FH-2024	30300-2024	20577083	1/4	31.8	1/2	2.50	63.5	2.91	74.0	6.67	169.5	NS	Y			Y
DG-FH-2424	16300-2424	20242308	1/2	38.1	1/2	2.50	63.5	2.26	57.5	6.30	160.0	DG	DGF2-24	DGF2-24		DGF1-24
S6-FH-2424	30300-2424	20241758	1/2	38.1	1/2	2.50	63.5	2.99	76.0	6.26	159.0	NS	Y			
DG-FH-2432	16300-2432	20242796	1/2	38.1	2	3.13	79.4	2.74	69.5	6.77	172.0	DG	DGF2-24	DGF2-24		DGF1-24
S6-FH-2432	30300-2432	20241756	1/2	38.1	2	3.13	79.4	3.46	88.0	6.73	171.0	NS	Y			
S6-FH-3224	30300-3224	20788098	2	50.8	1/2	2.50	63.5	2.99	76.0	6.92	175.8	NS	Y			
DG-FH-3232	16300-3232	20254307	2	50.8	2	3.13	79.4	2.87	73.0	7.24	184.0	DG	DGF2-32			DGF1-32
S6-FH-3232	30300-3232	20241748	2	50.8	2	3.13	79.4	2.87	73.0	7.24	184.0	DG	Y			

Descriptive #	Product #	SAP #	Hose Size ID		Flange Size	Flange Diameter (A)		Cut-Off (C)		Length (L)		Skive Type	SR13, ARC13	SR15, ARC15	S4SP	S4SH
			in.	mm		in.	mm	in.	mm	in.	mm					
SG-FH-0808	29300-0808	20822132	1/2	12.7	1/2	1.25	31.8	1.88	47.7	3.41	86.7	NS			Y	
SG-FH-0812	29300-0812	20822131	1/2	12.7	3/4	1.63	41.3	2.08	52.8	3.62	91.8	NS			Y	
SG-FH-1212	29300-1212	20822130	3/4	190	3/4	1.63	41.3	2.15	54.5	4.02	102.0	NS	Y	Y	Y	Y
SG-FH-1216	29300-1216	20822129	3/4	190	1	1.88	47.6	2.24	56.8	4.11	104.3	NS	Y	Y	Y	Y
SG-FH-1612	29300-1612	20822128	1	25.4	3/4	1.63	41.3	2.30	58.4	4.58	116.4	NS	Y	Y	Y	Y
SG-FH-1616	29300-1616	20822127	1	25.4	1	1.88	47.6	2.28	58.0	4.57	116.0	NS	Y	Y	Y	Y
SG-FH-1620	29300-1620	20822126	1	25.4	1/4	2.13	54.0	2.58	65.5	4.86	123.5	NS	Y	Y	Y	Y
SG-FH-2424	29300-2424	20757743	1/2	38.1	1/2	2.50	63.5	2.99	76.0	6.46	164.0	NS				Y
SG-FH-2432	29320-2432	20757726	1/2	38.1	2	3.13	79.4	Contact Continental ContiTech			NS					Y
SG-FH-3232	29300-3232	20833307	1	25.4	2	3.13	79.4	5.19	131.9	8.74	221.9	NS				Y

## Code 62 Flange (SAE J518)

22.5° Elbow



S=Skive  
NS=Non-Skive  
DG=Dual-Grip™

Descriptive #	Product #	SAP #	Hose Size ID		Flange Size	Flange Diameter (A)		Drop (D)		Cut-Off (C)		Length (L)		Skive Type	SR13, ARC13	SR15, ARC15	S4SP	S4SH
			in.	mm		in.	mm	in.	mm	in.	mm	in.	mm					
S6-FH22-1216	30303-1216	20293326	3/4	19.0	1	1.87	47.6	0.59	15.0	3.52	89.5	5.69	144.5	NS	Y			Y
S6-FH22-1616	30303-1616	20293327	1	25.4	1	1.87	47.6	0.61	15.5	4.29	109.0	6.81	173.0	NS	Y			Y
S6-FH22-2020	30303-2020	20577084	1¼	31.8	1¼	2.13	54.0	0.73	18.5	4.57	116.0	7.56	192.0	NS	Y			Y
S6-FH22-2024	30303-2024	20577085	1¼	31.8	1½	2.50	63.5	0.85	21.5	5.18	131.5	8.17	207.5	NS	Y			Y
S6-FH22-3232	30303-3232	20788097	2	50.2	2	3.13	79.4	0.98	25.0	5.71	145.0	9.39	238.4	NS	Y			

Descriptive #	Product #	SAP #	Hose Size ID		Flange Size	Flange Diameter (A)		Drop (D)		Cut-Off (C)		Length (L)		Skive Type	SR13, ARC13	SR15, ARC15	S4SP	S4SH
			in.	mm		in.	mm	in.	mm	in.	mm	in.	mm					
SG-FH22-1212	29303-1212	20822125	3/4	19.0	3/4	1.63	41.3	0.55	41.3	3.33	41.3	5.20	41.3	NS	Y	Y	Y	Y
SG-FH22-1216	29303-1216	20822124	3/4	19.0	1	1.88	41.3	0.59	41.3	3.39	41.3	5.26	41.3	NS	Y	Y	Y	Y
SG-FH22-1616	29303-1616	20822123	1	25.4	1	1.88	41.3	0.55	41.3	4.22	41.3	6.50	41.3	NS	Y	Y	Y	Y

## Code 62 Flange (SAE J518)

30° Elbow

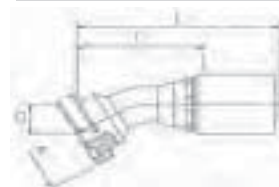

S=Skive  
NS=Non-Skive  
DG=Dual-Grip™

Descriptive #	Product #	SAP #	Hose Size ID		Flange Size	Flange Diameter (A)		Drop (D)		Cut-Off (C)		Length (L)		Skive Type	SR13, ARC13	SR15, ARC15	S4SP	S4SH
			in.	mm		in.	mm	in.	mm	in.	mm	in.	mm					
S6-FH30-1212	30305-1212	20293330	3/4	19.0	3/4	1.63	41.3	0.75	19.0	3.23	82.0	5.39	137.0	NS	Y			Y
S6-FH30-1616	30305-1616	20293331	1	25.4	1	1.87	47.6	0.96	24.5	4.17	106.0	6.69	170.0	NS	Y			Y
S6-FH30-2020	30305-2020	20577086	1¼	31.8	1¼	2.13	54.0	1.00	25.5	4.43	112.5	7.42	188.5	NS	Y			Y
S6-FH30-2024	30305-2024	20577087	1¼	31.8	1½	2.50	63.5	1.18	30.0	5.04	128.0	8.03	204.0	NS	Y			Y
S6-FH30-2424	30305-2424	20293334	1½	38.1	1½	2.50	63.5	1.16	29.5	6.06	154.0	9.33	237.0	NS	Y			
S6-FH30-3232	30305-3232	20293335	2	50.8	2	3.13	79.4	1.32	33.5	5.71	145.0	9.36	237.6	NS	Y			

Continued on next page

# Code 62 Flange (SAE J518)

## 30° Elbow Continued

Descriptive #	Product #	SAP #	Hose Size ID		Flange Size	Flange Diameter (A)		Drop (D)		Cut-Off (C)		Length (L)		Skive Type	SR13, ARC13	SR15, ARC15	S4SP	S4SH
			in.	mm		in.	mm	in.	mm	in.	mm	in.	mm					
SG-FH30-1212	29305-1212	20822122	3/4	19.0	3/4	1.63	41.3	0.73	18.5	3.27	83.0	5.14	130.5	NS	Y	Y	Y	Y
SG-FH30-1616	29305-1616	20822121	1	25.4	1	1.87	47.6	0.75	19.0	4.15	105.4	6.43	163.4	NS	Y	Y	Y	Y
SG-FH30-2424	29305-2424	20757730	1½	38.1	1½	2.50	63.5	Contact Continental ContiTech						NS				Y

# Code 62 Flange (SAE J518)

## 45° Elbow



S=Skive  
 NS=Non-Skive  
 DG=Dual-Grip™

Descriptive #	Product #	SAP #	Hose Size ID		Flange Size	Flange Diameter (A)		Drop (D)		Cut-Off (C)		Length (L)		Skive Type	SR13, ARC13	SR15, ARC15	S4SP	S4SH
			in.	mm		in.	mm	in.	mm	in.	mm	in.	mm					
DG-FH45-1212	16310-1212	20254308	3/4	19.0	3/4	1.63	41.3	1.18	30.0	2.83	72.0	5.35	136.0	DG	DGF1-12	DGF1-12	DGF1-12	DGF1-12
S6-FH45-1212	30310-1212	20241789	3/4	19.0	3/4	1.63	41.3	1.18	30.0	2.95	75.0	5.12	130.0	NS	Y			Y
DG-FH45-1216	16310-1216	20254309	3/4	19.0	1	1.87	47.6	1.30	33.0	3.03	77.0	5.55	141.0	DG	DGF1-12	DGF1-12	DGF1-12	DGF1-12
S6-FH45-1216	30310-1216	20241786	3/4	19.0	1	1.87	47.6	1.30	33.0	3.15	80.0	5.31	135.0	NS	Y			Y
DG-FH45-1616	16310-1616	20242417	1	25.4	1	1.87	47.6	1.38	35.0	3.74	95.0	6.73	171.0	DG	DGF1-16	DGF1-16	DGF1-16	DGF1-16
S6-FH45-1616	30310-1616	20241773	1	25.4	1	1.87	47.6	1.38	35.0	3.86	98.0	6.38	162.0	NS	Y			Y
DG-FH45-1620	16310-1620	20242301	1	25.4	1¼	2.13	54.0	1.73	44.0	3.58	91.0	6.61	168.0	DG	DGF1-16	DGF1-16	DGF1-16	DGF1-16
S6-FH45-1620	30310-1620	20241770	1	25.4	1¼	2.13	54.0	1.73	44.0	3.78	96.0	6.30	160.0	NS	Y			Y
DG-FH45-2020	16310-2020	20242303	1¼	31.8	1¼	2.13	54.0	1.56	39.5	4.02	102.0	7.44	189.0	DG	DGF2-20	DGF2-20		DGF1-20
S6-FH45-2020	30310-2020	20577088	1¼	31.8	1¼	2.13	54.0	1.61	41.0	4.06	103.0	7.83	199.0	NS	Y			Y
S6-FH45-2024	30310-2024	20577089	1¼	31.8	1½	2.50	63.5	1.89	48.0	4.61	117.0	8.39	213.0	NS	Y			Y
DG-FH45-2424	16310-2424	20242302	1½	38.1	1½	2.50	63.5	1.89	48.0	5.35	136.0	8.98	228.0	DG	DGF2-24	DGF2-24		DGF1-24
S6-FH45-2424	30310-2424	20241768	1½	38.1	1½	2.50	63.5	1.89	48.0	5.67	144.0	8.94	227.0	NS	Y			
DG-FH45-2432	16310-2432	20242795	1½	38.1	2	3.13	79.4	2.17	55.0	5.08	129.0	8.70	221.0	DG	DGF2-24	DGF2-24		DGF1-24
S6-FH45-2432	30310-2432	20241766	1½	38.1	2	3.13	79.4	2.17	55.0	5.39	137.0	8.66	220.0	NS	Y			
DG-FH45-3232	16310-3232	20254310	2	50.8	2	3.13	79.4	2.48	63.0	6.34	161.0	10.16	258.0	DG	DGF2-32			DGF1-32
S6-FH45-3232	30310-3232	20241779	2	50.8	2	3.13	79.4	2.21	56.0	6.10	155.0	10.03	254.8	NS	Y			

Descriptive #	Product #	SAP #	Hose Size ID		Flange Size	Flange Diameter (A)		Drop (D)		Cut-Off (C)		Length (L)		Skive Type	SR13, ARC13	SR15, ARC15	S4SP	S4SH
			in.	mm		in.	mm	in.	mm	in.	mm							
SG-FH45-0808	29310-0808	20822120	1/2	12.7	1/2	1.25	31.8	0.86	21.8	2.24	56.9	3.78	95.9	NS			Y	
SG-FH45-0812	29310-0812	20822119	1/2	12.7	3/4	1.63	41.4	1.08	27.5	2.99	75.8	4.52	114.8	NS			Y	
SG-FH45-1212	29310-1212	20822118	3/4	19.0	3/4	1.63	41.4	1.12	28.5	2.99	75.8	4.86	123.3	NS	Y	Y	Y	Y
SG-FH45-1216	29310-1216	20822117	3/4	19.0	1	1.88	47.6	1.26	32.0	3.07	78.0	4.94	125.5	NS	Y	Y	Y	Y
SG-FH45-1616	29310-1616	20822116	1	25.4	1	1.88	47.6	1.26	32.0	3.84	97.6	6.13	155.6	NS	Y	Y	Y	Y
SG-FH45-1620	29310-1620	20822115	1	25.4	1¼	2.13	54.1	1.50	38.0	3.78	96.0	6.06	154.0	NS	Y	Y	Y	Y
SG-FH45-2424	29310-2424	20757720	1½	38.1	1½	2.50		Contact Continental ContiTech						NS				Y
SG-FH45-2432	29340-2432	20757725	1½	38.1	2	3.13		Contact Continental ContiTech						NS				Y

## Code 62 Flange (SAE J518)

60° Elbow

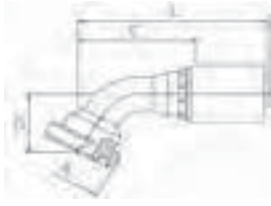

S=Skive  
NS=Non-Skive  
DG=Dual-Grip™

Descriptive #	Product #	SAP #	Hose Size ID		Flange Size	Flange Diameter (A)		Drop (D)		Cut-Off (C)		Length (L)		Skive Type	SR13, ARC13	SR15, ARC15	S4SP	S4SH
			in.	mm		in.	mm	in.	mm	in.	mm	in.	mm					
S6-FH60-1212	30312-1212	20293337	3/4	19.0	3/4	1.63	41.3	1.71	43.5	3.66	93.0	5.83	148.0	NS	Y			Y
S6-FH60-1616	30312-1616	20293338	1	25.4	1	1.87	47.6	1.87	47.5	4.21	107.0	6.73	171.0	NS	Y			Y
S6-FH60-2020	30312-2020	20577090	1¼	31.8	1¼	2.13	54.0	2.54	64.5	5.20	132.0	8.98	228.0	NS	Y			Y
S6-FH60-2024	30312-2024	20577091	1¼	31.8	1½	2.50	63.5	2.74	69.5	5.71	145.0	8.70	221.0	NS	Y			Y
S6-FH60-3232	30312-3232	20788099	2	50.8	2	3.13	79.4	3.27	83.0	5.71	145.0	9.64	244.8	NS	Y			Y

Descriptive #	Product #	SAP #	Hose Size ID		Flange Size	Flange Diameter (A)		Drop (D)		Cut-Off (C)		Length (L)		Skive Type	SR13, ARC13	SR15, ARC15	S4SP	S4SH
			in.	mm		in.	mm	in.	mm	in.	mm							
SG-FH60-1212	29312-1212	20822114	3/4	19.0	3/4	1.63	41.3	1.55	39.4	3.47	88.0	5.34	135.5	NS	Y	Y	Y	Y
SG-FH60-1616	29312-1616	20822113	1	25.4	1	1.87	47.6	1.73	44.0	4.15	105.4	6.43	163.4	NS	Y	Y	Y	Y

## Code 62 Flange (SAE J518)

67° Elbow

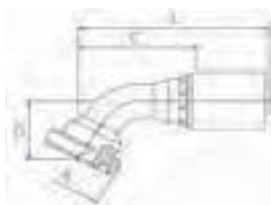

S=Skive  
NS=Non-Skive  
DG=Dual-Grip™

Descriptive #	Product #	SAP #	Hose Size ID		Flange Size	Flange Diameter (A)		Drop (D)		Cut-Off (C)		Length (L)		Skive Type	SR13, ARC13	SR15, ARC15	S4SP	S4SH
			in.	mm		in.	mm	in.	mm	in.	mm							
S6-FH67-1616	30313-1616	20293344	1	25.4	1	1.87	47.6	2.40	61.0	4.04	102.5	6.56	166.5	NS	Y			Y

Descriptive #	Product #	SAP #	Hose Size ID		Flange Size	Flange Diameter (A)		Drop (D)		Cut-Off (C)		Length (L)		Skive Type	SR13, ARC13	SR15, ARC15	S4SP	S4SH
			in.	mm		in.	mm	in.	mm	in.	mm							
SG-FH67-1616	29313-1616	20822112	1	25.4	1	1.87	47.6	2.40	61.0	3.84	97.6	6.13	155.6	NS	Y	Y	Y	Y

# Code 62 Flange (SAE J518)

## 90° Elbow

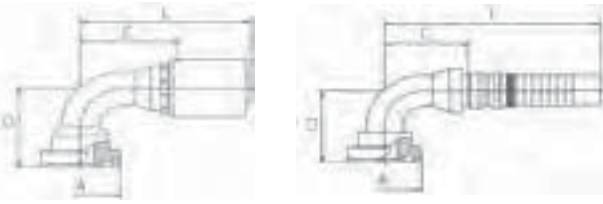

Elbow Type  
LT=Long Tube  
ST=Short Tube

S=Skive  
NS=Non-Skive  
DG=Dual-Grip™

Descriptive #	Product #	SAP #	Hose Size ID		Flange Size	Flange Diameter (A)		Elbow Type	Drop (D)		Cut-Off (C)		Length (L)	Skive Type	SR13, ARC13	SR15, ARC15	S4SP	S4SH	
			in.	mm		in.	mm		in.	mm	in.	mm							in.
SG-FH90-0808	29315-0808	20731761	1/2	12.7	1/2	1.25	31.8		1.67	42.4	1.89	48.0	3.43	87.0	NS			Y	
DG-FH90-1212	16315-1212	20254311	3/4	19.0	3/4	1.63	41.3		2.52	64.0	2.40	61.0	4.92	125.0	DG	DGF1-12	DGF1-12	DGF1-12	DGF1-12
S6-FH90-1212	30315-1212	20242952	3/4	19.0	3/4	1.63	41.3		2.52	64.0	2.56	65.0	4.72	120.0	NS	Y			Y
DG-FH90-1216	16315-1216	20254312	3/4	19.0	1	1.87	47.6		2.60	66.0	2.40	61.0	4.92	125.0	DG	DGF1-12	DGF1-12	DGF1-12	DGF1-12
S6-FH90-1216	30315-1216	20241733	3/4	19.0	1	1.87	47.6		2.60	66.0	2.56	65.0	4.72	120.0	NS	Y			Y
S6-FH90-1612	30315-1612	20293341	1	25.4	3/4	1.63	41.3		2.40	61.0	2.95	75.0	5.47	139.0	NS	Y			Y
DG-FH90-1616	16315-1616	20242604	1	25.4	1	1.87	47.6		2.91	74.0	2.76	70.0	5.79	147.0	DG	DGF1-16	DGF1-16	DGF1-16	DGF1-16
S6-FH90-1616	30315-1616	20241792	1	25.4	1	1.87	47.6		2.91	74.0	2.95	75.0	5.47	139.0	NS	Y			Y
DG-FH90-1620	16315-1620	20242466	1	25.4	1 1/4	2.13	54.0		3.15	80.0	3.03	77.0	6.06	154.0	DG	DGF1-16	DGF1-16	DGF1-16	DGF1-16
S6-FH90-1620	30315-1620	20241784	1	25.4	1 1/4	2.13	54.0		3.35	85.0	3.11	79.0	5.63	143.0	NS	Y			Y
DG-FH90-2020	16315-2020	20242305	1 1/4	31.8	1 1/4	2.13	54.0		3.58	91.0	3.46	88.0	6.89	175.0	DG	DGF2-20	DGF2-20		DGF1-20
S6-FH90-2020	30315-2020	20577092	1 1/4	31.8	1 1/4	2.13	54.0		3.58	91.0	3.78	96.0	7.56	192.0	NS	Y			Y
S6-FH90L-2020	30317-2020	20577094	1 1/4	31.8	1 1/4	2.13	54.0	LT	4.72	120.0	3.66	93.0	7.44	189.0	NS	Y			Y
DG-FH90-2024	16315-2024	20254313	1 1/4	31.8	1 1/2	2.50	63.5		4.07	103.5	3.66	93.0	7.09	180.0	DG	DGF2-20	DGF2-20		DGF1-20
S6-FH90-2024	30315-2024	20577093	1 1/4	31.8	1 1/2	2.50	63.5		4.07	103.5	3.90	99.0	7.64	194.0	NS	Y			Y
S6-FH90-2420	30315-2420	20241782	1 1/2	38.1	1 1/4	2.13	54.0		3.35	85.0	4.41	112.0	7.68	195.0	NS	Y			
DG-FH90-2424	16315-2424	20242304	1 1/2	38.1	1 1/2	2.50	63.5		4.29	109.0	4.17	106.0	7.80	198.0	DG	DGF2-24	DGF2-24		DGF1-24
S6-FH90-2424	30315-2424	20241783	1 1/2	38.1	1 1/2	2.50	63.5		4.29	109.0	4.49	114.0	7.76	197.0	NS	Y			
S6-FH90-2432	30315-2432	20293343	1 1/2	38.1	2	3.13	79.4		4.78	121.5	4.65	118.0	7.91	201.0	NS	Y			
DG-FH90-3232	16315-3232	20254314	2	50.8	2	3.13	79.4		5.45	138.5	5.87	149.0	9.69	246.0	DG	DGF2-32			DGF1-32
S6-FH90-3232	30315-3232	20241735	2	50.8	2	3.13	79.4		3.27	83.0	5.71	145.0	9.64	244.8	NS	Y			

Descriptive #	Product #	SAP #	Hose Size ID		Flange Size	Flange Diameter (A)		Elbow Type	Drop (D)		Cut-Off (C)		Length (L)	Skive Type	SR13, ARC13	SR15, ARC15	S4SP	S4SH	
			in.	mm		in.	mm		in.	mm	in.	mm							in.
SG-FH90-0808	29315-0808	20731761	1/2	12.7	1/2	1.25	31.8		1.67	42.4	1.89	48.0	3.43	87.0	NS			Y	
SG-FH90-080-0808	29317A-0808	20833294	1/2	12.7	1/2	1.25	31.8	LT	3.15	80.0	1.99	50.5	3.53	89.5	NS			Y	
SG-FH90-0812	29315-0812	20822111	1/2	12.7	3/4	1.63	41.4		2.28	58.0	1.89	48.0	3.43	87.0	NS			Y	
SG-FH90-1012	29315-1012	20822110	5/8	15.9	3/4	1.63	41.4		2.28	58.0	1.97	50.0	3.56	90.5	NS			Y	
SG-FH90-1212	29315-1212	20822109	3/4	19.1	3/4	1.63	41.3		2.28	58.0	2.36	59.8	4.23	107.3	NS	Y	Y	Y	Y
SG-FH90-100-1212	29317A-1212	20833293	3/4	19.1	3/4	1.63	41.3	LT	3.94	100.0	2.40	61.0	4.27	108.5	NS	Y	Y	Y	Y
SG-FH90-122-1212	29317B-1212	20833292	3/4	19.1	3/4	1.63	41.3	LT	4.80	122.0	2.80	71.1	4.67	118.6	NS	Y	Y	Y	Y
SG-FH90-1216	29315-1216	20822108	3/4	19.1	1	1.88	47.6		2.76	70.0	2.60	66.0	4.47	113.5	NS	Y	Y	Y	Y
SG-FH90-140-1216	29317A-1216	20833291	3/4	19.1	1	1.88	47.6	LT	5.51	140.0	2.56	65.0	4.43	112.5	NS	Y	Y	Y	Y
SG-FH90-1612	29315-1612	20822107	1	25.4	3/4	1.63	41.3		2.28	58.0	2.87	72.9	5.15	130.9	NS	Y	Y	Y	Y
SG-FH90-1616	29315-1616	20822106	1	25.4	1	1.88	47.6		2.76	70.1	2.97	75.4	5.25	133.4	NS	Y	Y	Y	Y
SG-FH90-090-1616	29317A-1616	20833290	1	25.4	1	1.88	47.6	LT	3.54	90.0	3.28	83.3	5.56	141.3	NS	Y	Y	Y	Y
SG-FH90-120-1616	29317B-1616	20833229	1	25.4	1	1.88	47.6	LT	4.72	120.0	3.04	77.2	5.32	135.2	NS	Y	Y	Y	Y
SG-FH90-1620	29315-1620	20822105	1	25.4	1 1/4	2.13	54.0		3.54	90.0	3.07	78.0	5.35	136.0	NS	Y	Y	Y	Y
SG-FH90-2424	29315-2424	20757498	1 1/2	38.1	1 1/2	2.50	63.5		Contact Continental ContiTech				NS					Y	
SG-FH90-2432	29315-2432	20757729	1 1/2	38.1	2	3.13	79.4		Contact Continental ContiTech				NS					Y	

# Caterpillar® Flange



S=Skive  
NS=Non-Skive  
DG=Dual-Grip™

Descriptive #	Product #	SAP #	Hose Size ID		Flange Size	Flange Diameter (A)		Cut-Off (C)		Length (L)		Skive Type	SR13, ARC13	SR15, ARC15	S4SP	S4SH
			in.	mm		in.	mm	in.	mm	in.	mm					
DG-CF-1212	16185-1212	20242290	3/4	19.0	3/4	1.63	41.3	2.99	76.0	5.75	146.0	DG	DGF1-12	DGF1-12	DGF1-12	DGF1-12
S6-CF-1212	30185-1212	20293345	3/4	19.0	3/4	1.63	41.3	3.37	85.5	5.53	140.5	NS	Y			Y
DG-CF-1216	16185-1216	20242794	3/4	19.0	1	1.87	47.6	2.99	76.0	5.75	146.0	DG	DGF1-12	DGF1-12	DGF1-12	DGF1-12
DG-CF-1616	16185-1616	20242413	1	25.4	1	1.87	47.6	3.23	82.0	6.56	166.5	DG	DGF1-16	DGF1-16	DGF1-16	DGF1-16
S6-CF-1616	30185-1616	20293346	1	25.4	1	1.87	47.6	3.72	94.5	6.24	158.5	NS	Y			Y
DG-CF-1620	16185-1620	20242447	1	25.4	1¼	2.13	54.0	3.23	82.0	6.56	166.5	DG	DGF1-16	DGF1-16	DGF1-16	DGF1-16
DG-CF-2020	16185-2020	20242448	1¼	31.8	1¼	2.13	54.0	2.98	75.8	6.81	173.0	DG	DGF2-20	DGF2-20		DGF1-20
S6-CF-2020	30185-2020	20577069	1¼	31.8	1¼	2.13	54.0	3.62	92.0	7.38	187.5	NS	Y			Y
DG-CF-2024	16185-2024	20242289	1¼	31.8	1½	2.50	63.5	2.87	72.8	6.69	170.0	DG	DGF2-20	DGF2-20		DGF1-20
S6-CF-2024	30185-2024	20551648	1¼	31.8	1½	2.50	63.5	3.43	87.0	7.19	182.5	NS	Y			Y
S6-CF-2424	30185-2424	20293347	1.5	38.1	1½	2.50	63.5	3.50	89.0	6.77	172.0	NS	Y			
S6-CF-3232	30185-3232	20293348	2	50.8	2	3.13	79.4	4.34	110.1	8.26	209.9	NS	Y			

Descriptive #	Product #	SAP #	Hose Size ID		Flange Size	Flange Diameter (A)		Cut-Off (C)		Length (L)		Skive Type	SR13, ARC13	SR15, ARC15	S4SP	S4SH
			in.	mm		in.	mm	in.	mm	in.	mm					
SG-CF-1212	29185-1212	20822200	3/4	19.0	3/4	1.63	41.3	3.38	85.8	5.25	133.2	NS	Y	Y	Y	Y
SG-CF-1216	29185-1216	20822199	3/4	19.0	1	1.88	47.6	3.50	88.9	5.37	136.4	NS	Y	Y	Y	Y
SG-CF-1612	29185-1612	20822198	1	25.4	3/4	1.63	41.3	3.47	88.0	5.75	146.0	NS	Y	Y	Y	Y
SG-CF-1616	29185-1616	20822197	1	25.4	1	1.88	47.6	3.69	93.8	6.00	152.3	NS	Y	Y	Y	Y
SG-CF-1620	29185-1620	20822196	1	25.4	1¼	2.13	54.0	3.62	92.0	5.91	150.0	NS	Y	Y	Y	Y
SG-CF-3232	29185-3232	20833299	2	50.8	2	3.13	79.4	4.48	113.9	8.03	203.8858	NS				Y

# Caterpillar® Flange

22.5° Elbow



S=Skive  
NS=Non-Skive  
DG=Dual-Grip™

Descriptive #	Product #	SAP #	Hose Size ID		Flange Size	Flange Diameter (A)		Drop (D)	Cut-Off (C)		Length (L)		Skive Type	SR13, ARC13	SR15, ARC15	S4SP	S4SH
			in.	mm		in.	mm		in.	mm	in.	mm					
S6-CF22-2020	30187-2020	20577070	1¼	31.8	1¼	2.13	54.0	0.79	20.0	6.42	163.0	9.41	239.0	NS	Y		Y
S6-CF22-2024	30187-2024	20545212	1¼	31.8	1½	2.50	63.5	0.87	22.0	6.69	170.0	10.47	266.0	NS	Y		Y

Continued on next page

# Caterpillar® Flange

## 22.5° Elbow Continued

Descriptive #	Product #	SAP #	Hose Size ID		Flange Size	Flange Diameter (A)		Drop (D)		Cut-Off (C)		Length (L)		Skive Type	SR13, ARC13	SR15, ARC15	S4SP	S4SH
			in.	mm		in.	mm	in.	mm	in.	mm	in.	mm					
S6-CF22-3232	30187-3232	20788095	2	50.8	2	3.13	79.4	0.98	25.0	4.34	110.1	8.26	209.9	NS	Y			
SG-CF22-1212	29187-1212	20822195	3/4	19.1	3/4	1.63	41.3	0.63	16.0	3.25	82.6	5.20	132.0	NS	Y	Y	Y	Y
SG-CF22-1616	29187-1616	20822194	1	25.4	1	1.88	47.6	0.71	18.0	4.217	107.1	6.50	165.1	NS	Y	Y	Y	Y
SG-CF22-1620	29187-1620	20822193	1	25.4	1 1/4	2.13	54.0	0.71	18.0	4.29	109.0	6.57	167.0	NS	Y	Y	Y	Y

# Caterpillar® Flange

## 30° Elbow

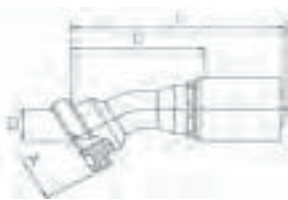

S=Skive  
NS=Non-Skive  
DG=Dual-Grip™

Descriptive #	Product #	SAP #	Hose Size ID		Flange Size	Flange Diameter (A)		Drop (D)		Cut-Off (C)		Length (L)		Skive Type	SR13, ARC13	SR15, ARC15	S4SP	S4SH
			in.	mm		in.	mm	in.	mm	in.	mm	in.	mm					
S6-CF30-1216	30188-1216	20441334	3/4	19.0	1	1.87	47.6	1.04	26.5	4.65	118.0	6.81	173.0	NS	Y			Y
S6-CF30-2020	30188-2020	20577072	1 1/4	31.8	1 1/4	2.13	54.0	1.10	28.0	5.96	151.5	8.96	227.5	NS	Y			Y
S6-CF30-2024	30188-2024	20577073	1 1/4	31.8	1 1/2	2.50	63.5	1.20	30.5	6.57	167.0	9.57	243.0	NS	Y			Y
S6-CF30-3232	30188-3232	20788096	2	50.8	2	3.13	79.4	1.38	35.0	6.54	166.2	10.47	266.0	NS	Y			

Descriptive #	Product #	SAP #	Hose Size ID		Flange Size	Flange Diameter (A)		Drop (D)		Cut-Off (C)		Length (L)		Skive Type	SR13, ARC13	SR15, ARC15	S4SP	S4SH
			in.	mm		in.	mm	in.	mm	in.	mm	in.	mm					
SG-CF30-1216	29188-1216	20822192	3/4	19.0	1	1.87	47.6	0.875	22.2	3.82	97.0	5.69	144.5	NS	Y	Y	Y	Y



# Caterpillar® Flange

45° Elbow

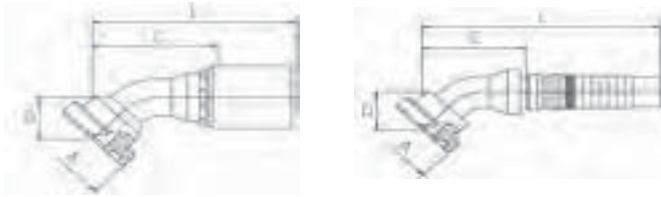

S=Skive  
NS=Non-Skive  
DG=Dual-Grip™

Descriptive #	Product #	SAP #	Hose Size ID		Flange Size	Flange Diameter (A)		Drop (D)		Cut-Off (C)		Length (L)		Skive Type	SR13, ARC13	SR15, ARC15	S4SP	S4SH
			in.	mm		in.	mm	in.	mm	in.	mm	in.	mm					
DG-CF45-1212	16190-1212	20242376	3/4	19.0	3/4	1.63	41.3	1.34	34.0	3.27	83.0	5.79	147.0	DG	DGF1-12	DGF1-12	DGF1-12	DGF1-12
S6-CF45-1212	30190-1212	20424961	3/4	19.0	3/4	1.63	41.3	1.34	34.0	4.06	103.0	6.22	158.0	NS	Y			Y
DG-CF45-1216	16190-1216	20242792	3/4	19.0	1	1.87	47.6	1.34	34.0	3.43	87.0	5.94	151.0	DG	DGF1-12	DGF1-12	DGF1-12	DGF1-12
DG-CF45-1616	16190-1616	20242410	1	25.4	1	1.87	47.6	1.57	40.0	3.70	94.0	6.69	170.0	DG	DGF1-16	DGF1-16	DGF1-16	DGF1-16
S6-CF45-1616	30190-1616	20424952	1	25.4	1	1.87	47.6	1.46	37.0	4.98	126.6	7.50	190.6	NS	Y			Y
DG-CF45-1620	16190-1620	20242446	1	25.4	1¼	2.13	54.0	1.57	40.0	3.74	95.0	6.77	172.0	DG	DGF1-16	DGF1-16	DGF1-16	DGF1-16
DG-CF45-2020	16190-2020	20242485	1¼	31.8	1¼	2.13	54.0	1.69	43.0	4.09	104.0	7.48	190.0	DG	DGF2-20	DGF2-20		DGF1-20
S6-CF45-2020	30190-2020	20577074	1¼	31.8	1¼	2.13	54.0	1.77	45.0	5.59	142.0	8.58	218.0	NS	Y			Y
DG-CF45-2024	16190-2024	20242810	1¼	31.8	1½	2.50	63.5	1.95	49.5	4.33	110.0	7.76	197.0	DG	DGF2-20	DGF2-20		DGF1-20
S6-CF45-2424	30190-2424	20424964	1½	38.1	1½	2.50	63.5	2.05	52.0	7.13	181.0	10.39	264.0	NS	Y			
S6-CF45-3232	30190-3232	20441298	2	50.8	2	3.13	79.4	2.76	70.0	6.54	166.2	10.47	266.0	NS	Y			

Descriptive #	Product #	SAP #	Hose Size ID		Flange Size	Flange Diameter (A)		Drop (D)		Cut-Off (C)		Length (L)		Skive Type	SR13, ARC13	SR15, ARC15	S4SP	S4SH
			in.	mm		in.	mm	in.	mm	in.	mm	in.	mm					
SG-CF45-1212	29190-1212	20822191	3/4	19.0	3/4	1.63	41.4	1.34	34.0	2.99	75.8	4.856	123.3	NS	Y	Y	Y	Y
SG-CF45-1216	29190-1216	20822190	3/4	19.0	1	1.88	47.6	1.34	34.0	3.50	88.9	5.37	136.4	NS	Y	Y	Y	Y
SG-CF45-1616	29190-1616	20822189	1	25.4	1	1.87	47.6	1.57	39.9	3.84	97.6	6.125	155.6	NS	Y	Y	Y	Y
SG-CF45-1620	29190-1620	20822188	1	25.4	1¼	2.13	54.0	1.50	38.0	3.86	98.0	6.143	156.0	NS	Y	Y	Y	Y

## Caterpillar® Flange

60° Elbow

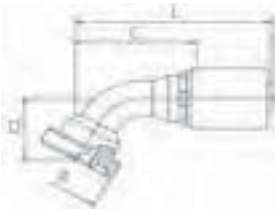

S=Skive  
NS=Non-Skive  
DG=Dual-Grip™

Descriptive #	Product #	SAP #	Hose Size ID		Flange Size	Flange Diameter (A)		Drop (D)		Cut-Off (C)		Length (L)		Skive Type	SR13, ARC13	SR15, ARC15	S4SP	S4SH
			in.	mm		in.	mm	in.	mm	in.	mm	in.	mm					
S6-CF60-1616	30192-1616	20293352	1	25.4	1	1.87	47.6	2.32	59.0	4.65	118.0	7.17	182.0	NS	Y			Y
S6-CF60-1620	30192-1620	20293353	1	25.4	1¼	2.13	54.0	2.24	57.0	4.65	118.0	7.17	182.0	NS	Y			Y
S6-CF60-2020	30192-2020	20577075	1¼	31.8	1¼	2.13	54.4	2.56	65.0	5.31	135.0	9.06	230.0	NS	Y			Y
S6-CF60-2024	30192-2024	20577076	1¼	31.8	1½	2.50	63.5	2.66	67.5	5.57	141.5	8.56	217.5	NS	Y			Y
S6-CF60-2424	30192-2424	20441299	1½	38.1	1½	2.50	63.5	2.85	72.5	6.46	164.0	9.76	248.0	NS	Y			
S6-CF60-2432	30192-2432	20441335	1½	38.1	2	3.13	79.4	3.35	85.0	5.71	145.0	8.98	228.0	NS	Y			
S6-CF60-3232	30192-3232	20441300	2	50.8	2	3.13	79.4	3.27	83.0	6.54	166.2	10.47	266.0	NS	Y			

Descriptive #	Product #	SAP #	Hose Size ID		Flange Size	Flange Diameter (A)		Drop (D)		Cut-Off (C)		Length (L)		Skive Type	SR13, ARC13	SR15, ARC15	S4SP	S4SH
			in.	mm		in.	mm	in.	mm	in.	mm	in.	mm					
SG-CF60-1616	29192-1616	20822187	1	25.4	1	1.87	47.6	2.09	53.1	4.15	105.4	6.43	163.4	NS	Y	Y	Y	Y
SG-CF60-1620	29192-1620	20822186	1	25.4	1¼	2.13	54.0	2.17	55.0	4.45	113.0	6.73	171.0	NS	Y	Y	Y	Y

## Caterpillar® Flange

67° Elbow

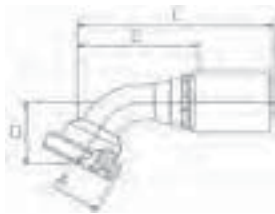

S=Skive  
NS=Non-Skive  
DG=Dual-Grip™

Descriptive #	Product #	SAP #	Hose Size ID		Flange Size	Flange Diameter (A)		Drop (D)		Cut-Off (C)		Length (L)		Skive Type	SR13, ARC13	SR15, ARC15	S4SP	S4SH
			in.	mm		in.	mm	in.	mm	in.	mm	in.	mm					
S6-CF67-2020	30194-2020	20545210	1¼	31.8	1¼	2.13	54.4	2.76	70.0	5.04	128.0	8.82	224.0	NS	Y			Y
S6-CF67-2024	30194-2024	20545211	1¼	31.8	1½	2.50	63.5	3.03	77.0	5.20	132.0	8.94	227.0	NS	Y			Y

# Caterpillar® Flange

90° Elbow

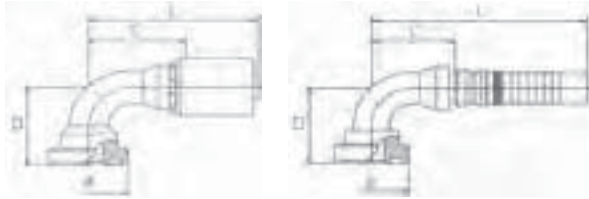

Elbow Type  
LT=Long Tube  
ST=Short Tube

S=Skive  
NS=Non-Skive  
DG=Dual-Grip™

Descriptive #	Product #	SAP #	Hose Size ID		Thread Size(A)		Hex-1 Wrench Size		Elbow Type	Drop (D)		Cut-Off (C)		Length (L)		Skive Type	SR13, ARC13	SR15, ARC15	S4SP	S4SH
			in.	mm	in.	mm	in.	mm		in.	mm	in.	mm	in.	mm					
DG-CF90-1212	16195-1212	20242377	3/4	19.0	3/4	1.63	41.3		2.64	67.0	2.52	64.0	5.04	128.0	DG	DGF1-12	DGF1-12	DGF1-12	DGF1-12	
S6-CF90-1212	30195-1212	20293356	3/4	19.0	3/4	1.63	41.3		2.64	67.0	2.64	67.0	4.80	122.0	NS	Y			Y	
DG-CF90-1216	16195-1216	20242793	3/4	19.0	1	1.87	47.6		2.76	70.0	2.56	65.0	5.08	129.0	DG	DGF1-12	DGF1-12	DGF1-12	DGF1-12	
DG-CF90-1616	16195-1616	20242411	1	25.4	1	1.87	47.6		3.11	79.0	3.15	80.0	6.18	157.0	DG	DGF1-16	DGF1-16	DGF1-16	DGF1-16	
S6-CF90-1616	30195-1616	20293357	1	25.4	1	1.87	47.6		3.11	79.0	3.35	85.0	5.87	149.0	NS	Y			Y	
S6-CF90L-1616	30197-1616	20293358	1	25.4	1	1.87	47.6	LT	5.20	132.0	3.35	85.0	5.87	149.0	NS	Y			Y	
DG-CF90-1620	16195-1620	20242811	1	25.4	1/4	2.13	54.0		3.25	82.5	2.95	75.0	5.98	152.0	DG	DGF1-16	DGF1-16	DGF1-16	DGF1-16	
DG-CF90-2020	16195-2020	20242288	1/4	31.8	1/4	2.13	54.0		3.66	93.0	3.50	89.0	6.93	176.0	DG	DGF2-20	DGF2-20		DGF1-20	
S6-CF90-2020	30195-2020	20577079	1/4	31.8	1/4	2.13	54.0		3.66	93.0	3.82	97.0	7.60	193.0	NS	Y			Y	
DG-CF90-2024	16195-2024	20242412	1/4	31.8	1/2	2.50	63.5		3.98	101.0	3.58	91.0	7.01	178.0	DG	DGF2-20	DGF2-20		DGF1-20	
S6-CF90-2424	30195-2424	20424954	1/2	38.1	1/2	2.50	63.5		4.29	109.0	4.61	117.0	7.87	200.0	NS	Y				
S6-CF90-3232	30195-3232	20441302	2	50.8	2	3.13	79.4		5.43	138.0	5.71	145.0	9.64	244.8	NS	Y				

Descriptive #	Product #	SAP #	Hose Size ID		Thread Size(A)		Hex-1 Wrench Size		Elbow Type	Drop (D)		Cut-Off (C)		Length (L)		Skive Type	SR13, ARC13	SR15, ARC15	S4SP	S4SH
			in.	mm	in.	mm	in.	mm		in.	mm	in.	mm	in.	mm					
SG-CF90-1212	29195-1212	20822185	3/4	19.0	3/4	1.63	41.3		2.60	66.0	2.36	59.8	4.23	107.3	NS	Y	Y	Y	Y	
SG-CF90-1216	29195-1216	20822184	3/4	19.0	1	1.63	41.3		2.76	70.1	2.65	67.3	4.52	114.8	NS	Y	Y	Y	Y	
SG-CF90-1616	29195-1616	20822183	1	25.4	1	1.87	47.6		3.11	79.0	2.97	75.4	5.25	133.4	NS	Y	Y	Y	Y	
SG-CF90L-1616	29197-1616	20822181	1	25.4	1	1.87	47.6	LT	5.20	132.1	3.35	85.1	5.63	143.1	NS	Y	Y	Y	Y	
SG-CF90-1620	29195-1620	20822182	1	25.4	1/4	2.13	54.0		3.54	90.0	3.07	78.0	5.35	136.0	NS	Y	Y	Y	Y	

# Komatsu® Flange



S=Skive  
NS=Non-Skive  
DG=Dual-Grip™

Descriptive #	Product #	SAP #	Hose Size ID		Flange Size	Flange Diameter (A)		Cut-Off (C)		Length (L)		Skive Type	SR13, ARC13	SR15, ARC15	S4SP	S4SH
			in.	mm		in.	mm	in.	mm	in.	mm					
SG-KF-0810	29530-0810	20821988	1/2	12.7	5/8	1.34	34.0	1.83	46.6	3.39	86.1	NS			Y	
SG-KF-1010	29530-1010	20821987	5/8	15.9	5/8	1.34	34.0	1.84	46.8	3.44	87.3	NS			Y	
SG-KF-1210	29530-1210	20821986	3/4	19.1	5/8	1.34	34.0	1.99	50.5	3.86	98.0	NS	Y	Y	Y	Y

# Komatsu® Flange

45° Elbow



S=Skive  
NS=Non-Skive  
DG=Dual-Grip™

Descriptive #	Product #	SAP #	Hose Size ID		Flange Size		Flange Diameter (A)		Drop (D)		Cut-Off (C)		Length (L)		Skive Type	SR13, ARC13	SR15, ARC15	S4SP	S4SH
			in.	mm	in.	mm	in.	mm	in.	mm	in.	mm	in.	mm					
SG-KF45-1010	29535-1010	20821985	5/8	15.9	5/8	1.34	34.0	0.98	24.9	2.32	58.9	3.91	99.4	NS			Y		

# Komatsu® Flange

90° Elbow

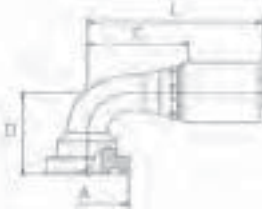

S=Skive  
NS=Non-Skive  
DG=Dual-Grip™

Descriptive #	Product #	SAP #	Hose Size ID		Flange Size		Flange Diameter (A)		Drop (D)		Cut-Off (C)		Length (L)		Skive Type	SR13, ARC13	SR15, ARC15	S4SP	S4SH
			in.	mm	in.	mm	in.	mm	in.	mm	in.	mm	in.	mm					
SG-KF90-1010	29540-1010	20821984	5/8	15.9	5/8	1.34	34.0	2.01	51.1	1.97	50.0	3.56	90.5	NS			Y		
SG-KF90-1210	29540-1210	20821983	3/4	19.1	5/8	1.34	34.0	2.01	51.1	2.17	55.1	4.04	102.6	NS	Y	Y	Y	Y	

# BSPF (British Standard Pipe Parallel)

Female | Swivel



S=Skive  
NS=Non-Skive  
DG=Dual-Grip™

Descriptive #	Product #	SAP #	Hose Size ID		Thread Size (A)		Hex-1 Wrench Size	Cut-Off (C)		Length (L)		Skive Type	SR13, ARC13	SR15, ARC15	S4SP	S4SH
			in.	mm	mm	in.		mm	in.	mm						
SG-BPFX-0808	29105-0808	20731754	1/2	12.7	1/2-14							NS			Y	
DG-BPFX-1212 <sup>T</sup>	16105-1212	20242375	3/4	19.0	3/4-14	32	0.89	22.5	3.75	95.2	DG	DGF1-12	DGF1-12	DGF1-12		DGF1-12
S6-BPFX-1212	30105-1212	20424839	3/4	19.0	3/4-14	32	0.99	25.2	3.50	89.0	NS	Y				Y
S6-BPFX-1616	30105-1616	20424940	1	25.4	1-11	38	1.22	31.0	4.15	105.5	NS	Y				Y
S6-BPFX-2020	30105-2020	20577065	1 1/4	31.8	1 1/4-11	50	1.38	35.0	5.53	140.5	NS	Y				Y
DG-BPFX-3232 <sup>T</sup>	16105-3232	20242791	2	50.8	2-11	70	1.30	33.0	5.75	146.1	DG	DGF2-32				DGF1-32
S6-BPFX-3232	30105-3232	20788090	2	50.8	2-11	70	2.38	60.4	6.31	160.1	NS	Y				

T: Thrust-Wire Nut (see "Fitting Identification" in Appendix for details)  
DG: Part listed is Dual-Grip™ style (image is Uni-Crimp™ style)

Continued on next page

# BSPB (British Standard Pipe Parallel)

Female | Swivel Continued

Descriptive #	Product #	SAP #	Hose Size ID		Thread Size (A)	Hex-1 Wrench Size	Cut-Off (C)		Length (L)		Skive Type	SR13, ARC13	SR15, ARC15	S4SP	S4SH
			in.	mm	mm	in.	mm	in.	mm						
SG-BPFX-0608	29105-0608	20822223	3/8	9.5	1/2-14	27	1.036	26.3	2.493	63.3	NS			Y	
SG-BPFX-0808	29105-0808	20731754	1/2	12.7	1/2-14	27	1.221	31.0	2.535	64.4	NS			Y	
SG-BPFX-0810	29105-0810	20822222	1/2	12.7	5/8-14	27	1.151	29.2	2.382	60.5	NS			Y	
SG-BPFX-1212	29105-1212	20822221	3/4	19.1	3/4-14	32	1.385	35.2	3.256	82.7	NS	Y	Y	Y	Y
SG-BPFX-1616	29105-1616	20822220	1	25.4	1-11	38	1.628	41.4	3.911	99.3	NS	Y	Y	Y	Y
SG-BPFX-2424	29105-2424	20757733	1½	38.1	1½-11	55	2.80	71.1	6.26	159.1	NS				Y
SG-BPFX-3232	29105-3232	20833296	2	50.8	2-11	70	2.54	64.5	6.09	154.6	NS				Y

# BSPB (British Standard Pipe Parallel)

Female | 45° Elbow | Swivel

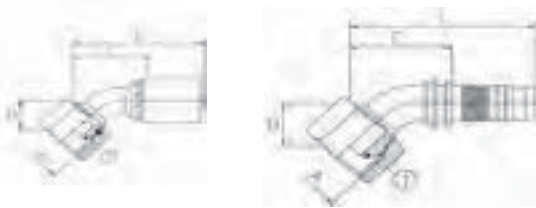

S=Skive  
NS=Non-Skive  
DG=Dual-Grip™

Descriptive #	Product #	SAP #	Hose Size ID		Thread Size	Hex-1 Wrench Size	Drop (D)		Cut-Off (C)		Length (L)		Skive Type	SR13, ARC13	SR15, ARC15	S4SP	S4SH
			in.	mm	mm	in.	mm	in.	mm	in.	mm						
DG-BPFX45-1616 <sup>T</sup>	16115-1616	20242802	1	25.4	1-11	38	1.34	34.0	3.19	81.0	6.43	163.3	DG	DGF1-16	DGF1-16	DGF1-16	DGF1-16
DG-BPFX45-2020 <sup>T</sup>	16115-2020	20242287	1¼	31.8	1¼-11	50	1.57	40.0	3.82	97.0	7.44	189.0	DG	DGF2-20	DGF2-20		DGF1-20
DG-BPFX45-2424 <sup>T</sup>	16115-2424	20242286	1½	38.1	1½-11	55	1.81	46.0	4.45	113.0	8.29	210.6	DG	DGF2-24	DGF2-24		DGF1-24
DG-BPFX45-3232 <sup>T</sup>	16115-3232	20242788	2	50.8	2-11	70	2.36	60.0	5.94	151.0	10.08	256.0	DG	DGF2-32			DGF1-32
S6-BPFX45-3232	30115-3232	20788091	2	50.8	2-11	70	2.76	70.0	6.54	166.2	10.47	266.0	NS	Y			

T: Thrust-Wire Nut (see "Fitting Identification" in Appendix for details)

Descriptive #	Product #	SAP #	Hose Size ID		Thread Size	Hex-1 Wrench Size	Drop (D)		Cut-Off (C)		Length (L)		Skive Type	SR13, ARC13	SR15, ARC15	S4SP	S4SH
			in.	mm	mm	in.	mm	in.	mm	in.	mm						
SG-BPFX45-0808	29115-0808	20822218	1/2	12.7	1/2-14	27	27	0.83	2.11	2.17	55.1	3.705	94.1			Y	
SG-BPFX45-1212	29115-1212	20822217	3/4	19.1	3/4-14	32	32	1.08	2.74	2.789	70.8	4.912	124.8	Y	Y	Y	Y
SG-BPFX45-1616	29115-1616	20822216	1	25.4	1-11	38	38	1.34	34.0	3.31	84.1	5.593	142.1	Y	Y	Y	Y
SG-BPFX45-2424	29115-2424	20757734	1½	38.1	1½-11		Contact Continental ContiTech					NS				Y	

# BSPF (British Standard Pipe Parallel)

Female | 90° Elbow | Swivel

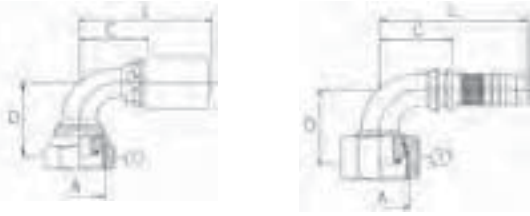

S=Skive  
NS=Non-Skive  
DG=Dual-Grip™

Descriptive #	Product #	SAP #	Hose Size ID		Thread Size	Hex-1 Wrench Size	Drop (D)		Cut-Off (C)		Length (L)		Skive Type	SR13, ARC13	SR15, ARC15	S4SP	S4SH
			in.	mm			in.	mm	in.	mm	in.	mm					
S6-BPFX90-1212	30120-1212	20424914	3/4	19.0	3/4-14	32	2.40	61.0	2.32	59.0	4.49	114.0	NS	Y			Y
DG-BPFX90-1616 <sup>C</sup>	16120-1616	20242804	1	25.4	1-11	38	2.80	71.0	2.95	75.0	5.94	151.0	DG	DGF1-16	DGF1-16	DGF1-16	DGF1-16
S6-BPFX90-1616	30120-1616	20424915	1	25.4	1-11	38	2.80	71.0	2.91	74.0	5.43	138.0	NS	Y			Y
S6-BPFX90-2020	30120-2020	20577067	1 1/4	31.8	1 1/4-11	50	3.27	83.0	3.31	84.0	6.30	160.0	NS	Y			Y
DG-BPFX90-2424 <sup>T</sup>	16120-2424	20242789	1 1/2	38.1	1 1/2-11	55	3.78	96.0	3.66	93.0	7.28	185.0	DG	DGF2-24	DGF2-24		DGF1-24
S6-BPFX90-2424	30110-2424	20424917	1 1/2	38.1	1 1/2-11	55	Contact Continental ContiTech						NS	Y			
DG-BPFX90-3232 <sup>T</sup>	16120-3232	20242790	2	50.8	2-11	70	4.92	125.0	5.47	139.0	9.29	236.0	DG	DGF2-32			DGF1-32
S6-BPFX90-3232	30120-3232	20788092	2	50.8	2-11	70	5.51	140.0	5.71	145.0	9.63	244.5	NS	Y			

C: Crimp Nut T: Thrust-Wire Nut (see "Fitting Identification" in Appendix for details)

DG: Part listed is Dual-Grip™ style (image is Uni-Crimp™ style)

Descriptive #	Product #	SAP #	Hose Size ID		Thread Size	Hex-1 Wrench Size	Drop (D)		Cut-Off (C)		Length (L)		Skive Type	SR13, ARC13	SR15, ARC15	S4SP	S4SH
			in.	mm			in.	mm	in.	mm	in.	mm					
SG-BPFX90-0608	29120-0608	20822214	3/8	9.5	1/2-14	27	1.40	35.6	1.34	34.0	2.80	71.0	NS			Y	
SG-BPFX90-0808	29120-0808	20731763	1/2	12.7	1/2-14	27	1.61	40.9	1.42	36.1	2.96	75.1	NS			Y	
SG-BPFX90-1212	29120-1212	20822213	3/4	19.1	3/4-14	32	2.24	56.9	2.35	59.7	4.22	107.2	NS	Y	Y	Y	Y
SG-BPFX90-1616	29120-1616	20822212	1	25.4	1-11	38	2.80	71.1	3.05	77.3	5.33	135.3	NS	Y	Y	Y	Y
SG-BPFX90-2424	29120-2424	20757732	1 1/2	38.1	1 1/2-11		Contact Continental ContiTech						NS				Y

## BSPP (British Standard Pipe Parallel)

Male

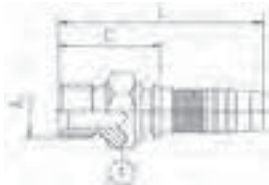

S=Skive  
NS=Non-Skive  
DG=Dual-Grip™

Descriptive #	Product #	SAP #	Hose Size ID		Thread Size (A)	Hex-1 Wrench Size	Cut-Off (C)		Length (L)		Skive Type	SR13, ARC13	SR15, ARC15	S4SP	S4SH
			in.	mm			mm	in.	mm	in.					
S6-BPM-1212	30130-1212	20424918	3/4	19.0	3/4-14	32	1.48	37.5	3.64	92.5	NS	Y			Y
S6-BPM-1616	30130-1616	20424919	1	25.4	1-11	41	1.75	44.5	4.27	108.5	NS	Y			Y
S6-BPM-2020	30130-2020	20577068	1¼	31.8	1¼-11	50	2.01	51.0	5.77	146.5	NS	Y			Y
S6-BPM-2424	30130-2424	20424951	1½	38.1	1½-11	50	2.20	55.9	5.47	138.8	NS	Y			
S6-BPM-3232	30130-3232	20788093	2	50.8	2-11	70	2.66	67.5	6.59	167.3	NS	Y			

Descriptive #	Product #	SAP #	Hose Size ID		Thread Size (A)	Hex-1 Wrench Size	Cut-Off (C)		Length (L)		Skive Type	SR13, ARC13	SR15, ARC15	S4SP	S4SH
			in.	mm			mm	in.	mm	in.					
SG-BPM-0606	29130-0606	20822211	3/8	9.5	3/8-19	22	1.20	30.5	2.66	67.5	NS			Y	
SG-BPM-0608	29130-0608	20822210	3/8	9.5	1/2-14	27	1.34	34.0	2.80	71.0	NS			Y	
SG-BPM-0806	29130-0806	20822209	1/2	12.7	3/8-19	22	1.20	30.5	2.74	69.5	NS			Y	
SG-BPM-0808	29130-0808	20822208	1/2	12.7	1/2-14	27	1.34	34.0	2.88	73.1	NS			Y	
SG-BPM-1212	29130-1212	20822207	3/4	19.0	3/4-14	32	1.56	39.6	3.43	87.1	NS	Y	Y	Y	Y
SG-BPM-1616	29130-1616	20822206	1	25.4	1-11	36	1.86	47.1	4.14	105.1	NS	Y	Y	Y	Y
SG-BPM-2424	29130-2424	20757731	1½	38.1	1½-11	50	2.46	62.4	5.92	150.4	NS				Y
SG-BPM-3232	29130-3232	20833303	2	50.8	2-11	70	2.81	71.3	6.35	161.3	NS				Y

## BSPT (British Standard Pipe Tapered)

Male

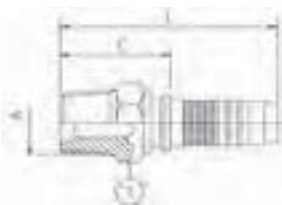

S=Skive  
NS=Non-Skive  
DG=Dual-Grip™

Descriptive #	Product #	SAP #	Hose Size ID		Thread Size (A)	Hex-1 Wrench Size	Cut-Off (C)		Length (L)		Skive Type	SR13, ARC13	SR15, ARC15	S4SP	S4SH
			in.	mm			mm	in.	mm	in.					
S6-BTM-3232	30170-3232	20788094	2	50.8	2-11	70	2.53	64.1	6.453	163.9	NS	Y			

Continued on next page

## BSPT (British Standard Pipe Tapered)

Male Continued

Descriptive #	Product #	SAP #	Hose Size ID		Thread Size (A)	Hex-1 Wrench Size	Cut-Off (C)		Length (L)		Skive Type	SR13, ARC13	SR15, ARC15	S4SP	S4SH
			in.	mm			mm	in.	mm	in.					
SG-BTM-0606	29170-0606	20822205	3/8	9.5	3/8-19	22	1.20	30.5	2.656	67.5	NS			Y	
SG-BTM-0808	29170-0808	20822204	1/2	12.7	1/2-14	27	1.37	34.9	2.91	73.9	NS			Y	
SG-BTM-1212	29170-1212	20822203	3/4	19.0	3/4-14	22	1.48	37.5	3.347	85.0	NS	Y	Y	Y	Y
SG-BTM-1616	29170-1616	20822202	1	25.4	1-11	27	1.89	48.1	4.176	106.1	NS	Y	Y	Y	Y
SG-BTM-3232	29170-3232	20833297	2	50.8	2-11	32	2.67	67.9	6.216	157.9	NS				Y

## BSP Flat Seat (British Standard Pipe)

Female | Swivel

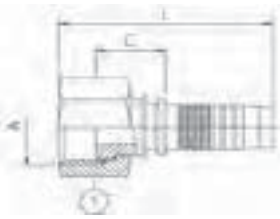

S=Skive  
NS=Non-Skive  
DG=Dual-Grip™

Descriptive #	Product #	SAP #	Hose Size ID		Thread Size (A)	Hex-1 Wrench Size	Cut-Off (C)		Length (L)		Skive Type	SR13, ARC13	SR15, ARC15	S4SP	S4SH
			in.	mm			mm	in.	mm	in.					
SG-BFFX-0608	29100-0608	20822227	3/8	9.5	1/2-14	27	0.80	20.3	2.26	57.3	NS			Y	
SG-BFFX-0808	29100-0808	20822226	1/2	12.7	1/2-14	27	0.82	20.9	2.36	59.8	NS			Y	
SG-BFFX-0812	29100-0812	20822225	1/2	12.7	3/4-14	32	1.00	25.4	2.54	64.4	NS			Y	

## DIN 24° Light

Female | Swivel



S=Skive  
NS=Non-Skive  
DG=Dual-Grip™

Descriptive #	Product #	SAP #	Hose Size ID		Thread Size (A)	Hex-1 Wrench Size	Cut-Off (C)		Length (L)		Skive Type	SR13, ARC13	SR15, ARC15	S4SP	S4SH
			in.	mm			mm	in.	mm	in.					
SG-DLFX-0618	29240-0618	20758288	3/8	9.5	18x1.5						NS			Y	
SG-DLFX-0822	29240-0822	20758302	1/2	12.7	22x1.5	27	1.21	30.7	2.46	62.4	NS			Y	
SG-DLFX-1230	29240-1230	20822154	3/4	19.1	30x2.0	36	1.42	36.0	3.29	83.5	NS	Y	Y	Y	Y
SG-DLFX-1236	29240-1236	20822153	3/4	19.1	36x2.0	41	1.60	40.7	3.47	88.2	NS	Y	Y	Y	Y
SG-DLFX-1636	29240-1636	20822152	1	25.4	36x2.0	41	1.49	37.9	3.60	91.5	NS	Y	Y	Y	Y



## DIN 24° Light

Female | 45° Elbow | Swivel

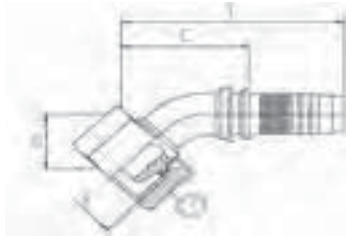

S=Skive  
NS=Non-Skive  
DG=Dual-Grip™

Descriptive #	Product #	SAP #	Hose Size ID		Thread Size	Hex-1 Wrench Size	Drop (D)		Cut-Off (C)		Length (L)		Skive Type	SR13, ARC13	SR15, ARC15	S4SP	S4SH
			in.	mm			in.	mm	in.	mm	in.	mm					
SG-DLFX45-0822	29245-0822	20822150	1/2	12.7	22x1.5	27	0.83	21.1	2.17	55.1	3.71	94.1	NS			Y	
SG-DLFX45-1230	29245-1230	20822149	3/4	19.1	30x2.0	36	1.26	32.0	2.72	69.1	4.59	116.6	NS	Y	Y	Y	Y
SG-DLFX45-1636	29245-1636	20822148	1	25.4	36x2.0	41	1.26	32.0	3.58	90.9	5.86	148.9	NS	Y	Y	Y	Y

## DIN 24° Light

Female | 90° Elbow | Swivel

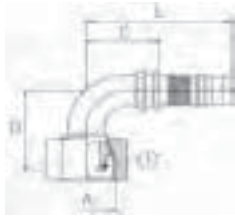

S=Skive  
NS=Non-Skive  
DG=Dual-Grip™

Descriptive #	Product #	SAP #	Hose Size ID		Thread Size	Hex-1 Wrench Size	Drop (D)		Cut-Off (C)		Length (L)		Skive Type	SR13, ARC13	SR15, ARC15	S4SP	S4SH
			in.	mm			in.	mm	in.	mm	in.	mm					
SG-DLFX90-0822	29250-0822	20822146	1/2	12.7	22x1.5	27	1.59	40.4	1.57	39.9	3.11	78.9	NS			Y	
SG-DLFX90-1230	29250-1230	20822144	3/4	19.1	30x2.0	36	2.32	58.9	2.05	52.1	3.92	99.6	NS	Y	Y	Y	Y
SG-DLFX90-1636	29250-1636	20822143	1	25.4	36x2.0	41	2.68	68.1	3.07	78.0	5.35	136.0	NS	Y	Y	Y	Y

## DIN 24° Light

Male



S=Skive  
NS=Non-Skive  
DG=Dual-Grip™

Descriptive #	Product #	SAP #	Hose Size ID		Thread Size (A)	Hex-1 Wrench Size	Cut-Off (C)		Length (L)		Skive Type	SR13, ARC13	SR15, ARC15	S4SP	S4SH
			in.	mm			in.	mm	in.	mm					
SG-DLM-0822	29255-0822	20822140	1/2	12.7	22x1.5	22	1.10	28.0	2.64	67.0	NS			Y	
SG-DLM-1230	29255-1230	20822139	3/4	19.1	30x2.0	32	1.35	34.3	3.22	81.8	NS	Y	Y	Y	Y
SG-DLM-1636	29255-1636	20822138	1	25.4	36x2.0	36	1.50	38.2	3.79	96.2	NS	Y	Y	Y	Y

## DIN 24° Heavy

Female | Swivel

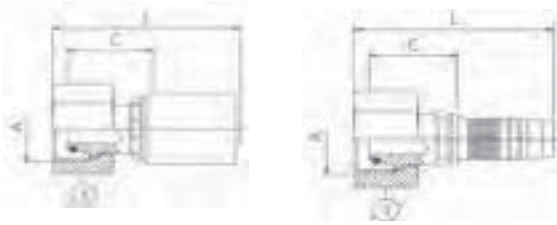

S=Skive  
NS=Non-Skive  
DG=Dual-Grip™

Descriptive #	Product #	SAP #	Hose Size ID		Thread Size (A)	Hex-1 Wrench Size	Cut-Off (C)		Length (L)		Skive Type	SR13, ARC13	SR15, ARC15	S4SP	S4SH
			in.	mm			in.	mm	in.	mm					
DG-DHFX-1230 <sup>T</sup>	16210-1230	20242320	3/4	19.0	30x2.0	36	1.47	37.3	4.17	106.0	DG	DGF1-12	DGF1-12	DGF1-12	DGF1-12
S6-DHFX-1230	30210-1230	20424955	3/4	19.0	30x2.0	36	1.45	36.8	3.80	96.5	NS	Y			Y
DG-DHFX-1236	16210-1236	20274104	3/4	19.0	36x2.0	36	1.79	45.5	4.30	109.3	DG	DGF1-12	DGF1-12	DGF1-12	DGF1-12
DG-DHFX-1642	16210-1642	20242422	1	25.4	42x2.0	50	1.78	45.3	4.99	126.8	DG	DGF1-16	DGF1-16	DGF1-16	DGF1-16
S6-DHFX-1642	30210-1642	20424956	1	25.4	42x2.0	50	1.78	45.3	4.50	114.2	NS	Y			Y
DG-DHFX-2052	16210-2052	20242423	1 1/4	31.8	52x2.0	60	1.78	45.3	5.60	142.2	DG	DGF2-20	DGF2-20		DGF1-20
S6-DHFX-2052	30210-2052	20577080	1 1/4	31.8	52x2.0	60	2.01	51.1	6.16	156.5	NS	Y			Y

T: Thrust-Wire Nut (see "Fitting Identification" in Appendix for details)

DG: Part listed is Dual-Grip™ style (image is Uni-Crimp™ style)

Descriptive #	Product #	SAP #	Hose Size ID		Thread Size (A)	Hex-1 Wrench Size	Cut-Off (C)		Length (L)		Skive Type	SR13, ARC13	SR15, ARC15	S4SP	S4SH
			in.	mm			in.	mm	in.	mm					
SG-DHFX-0620	29210-0620	20774066	3/8	9.5	20x1.5	24	1.21	30.8	2.669	67.8	NS			Y	
SG-DHFX-0622	29210-0622	20822180	3/8	9.5	22x1.5	27	1.42	36.2	2.881	73.2	NS			Y	
SG-DHFX-0824	29210-0824	20731609	1/2	12.7	24x1.5	30	1.44	36.5	2.785	70.7	NS			Y	
SG-DHFX-1030	29210-1030	20822179	5/8	15.9	30x2.0	36	1.64	41.7	3.234	82.1	NS			Y	
SG-DHFX-1230	29210-1230	20822178	3/4	19.1	30x2.0	36	1.60	40.7	3.328	84.5	NS	Y	Y	Y	Y
SG-DHFX-1236	29210-1236	20774357	3/4	19.1	36x2.0	46	1.89	47.9	3.756	95.4	NS	Y	Y	Y	Y
SG-DHFX-1636	29210-1636	20822176	1	25.4	36x2.0	46	2.17	55.1	4.455	113.2	NS	Y	Y	Y	Y
SG-DHFX-1642	29210-1642	20822175	1	25.4	42x2.0	50	1.88	47.9	4.167	105.8	NS	Y	Y	Y	Y

# DIN 24° Heavy

Female | 45° Elbow | Swivel

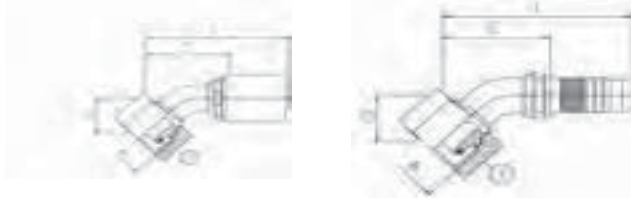

S=Skive  
NS=Non-Skive  
DG=Dual-Grip™

Descriptive #	Product #	SAP #	Hose Size ID		Thread Size (A)	Hex-1 Wrench Size	Drop (D)		Cut-Off (C)		Length (L)		Skive Type	SR13, ARC13	SR15, ARC15	S4SP	S4SH
			in.	mm			in.	mm	in.	mm	in.	mm					
DG-DHFX45-1236	16215-1236	20298071	3/4	19.0	36x2.0	46	1.42	36.0	3.07	78.1	5.72	145.4	DG	DGF1-12	DGF1-12	DGF1-12	DGF1-12
DG-DHFX45-1642	16215-1642	20242311	1	25.4	42x2.0	50	1.97	50.0	3.81	96.8	6.92	175.8	DG	DGF1-16	DGF1-16	DGF1-16	DGF1-16

Descriptive #	Product #	SAP #	Hose Size ID		Thread Size (A)	Hex-1 Wrench Size	Drop (D)		Cut-Off (C)		Length (L)		Skive Type	SR13, ARC13	SR15, ARC15	S4SP	S4SH
			in.	mm			in.	mm	in.	mm	in.	mm					
SG-DHFX45-0620	29215-0620	20822174	3/8	9.5	20x1.5	24	0.79	20.1	2.01	51.1	3.47	88.1	NS			Y	
SG-DHFX45-0622	29215-0622	20822173	3/8	9.5	22x1.5	27	0.83	21.1	2.09	53.1	3.55	90.1	NS			Y	
SG-DHFX45-0824	29215-0824	20822172	1/2	12.7	24x1.5	30	0.85	21.6	2.20	55.9	3.74	94.9	NS			Y	
SG-DHFX45-1236	29215-1236	20822171	3/4	19.1	36x2.0	46	1.30	33.0	2.72	69.1	4.59	116.6	NS	Y	Y	Y	Y
SG-DHFX45-1642	29215-1642	20822170	1	25.4	42x2.0	50	1.59	40.4	4.33	110.0	6.61	168.0	NS	Y	Y	Y	Y

# DIN 24° Heavy

Female | 90° Elbow | Swivel

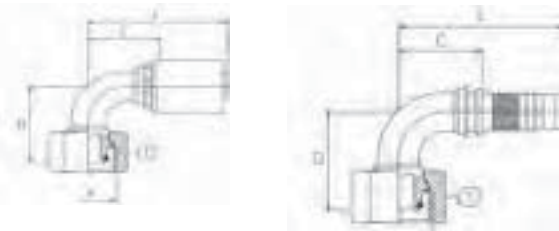

S=Skive  
NS=Non-Skive  
DG=Dual-Grip™

Descriptive #	Product #	SAP #	Hose Size ID		Thread Size (A)	Hex-1 Wrench Size	Drop (D)		Cut-Off (C)		Length (L)		Skive Type	SR13, ARC13	SR15, ARC15	S4SP	S4SH
			in.	mm			in.	mm	in.	mm	in.	mm					
DG-DHFX90-1236	16220-1236	20242318	3/4	19.0	36x2.0	46	2.56	65.0	2.44	62.0	4.96	126.0	DG	DGF1-12	DGF1-12	DGF1-12	DGF1-12

Descriptive #	Product #	SAP #	Hose Size ID		Thread Size (A)	Hex-1 Wrench Size	Drop (D)		Cut-Off (C)		Length (L)		Skive Type	SR13, ARC13	SR15, ARC15	S4SP	S4SH
			in.	mm			in.	mm	in.	mm	in.	mm					
SG-DHFX90-0620	29220-0620	20822169	3/8	9.5	20x1.5	24	1.52	38.6	1.34	34.0	2.80	71.0	NS			Y	
SG-DHFX90-0622	29220-0622	20822168	3/8	9.5	22x1.5	27	1.59	40.4	1.34	34.0	2.80	71.0	NS			Y	
SG-DHFX90-0824	29220-0824	20731752	1/2	12.7	24x1.5	30	1.63	41.4	1.57	39.9	3.11	78.9	NS			Y	
SG-DHFX90-1030	29220-1030	20822167	5/8	15.9	30x2.0	36	2.17	55.1	1.97	50.0	3.56	90.5	NS			Y	
SG-DHFX90-1230	29220-1230	20822166	3/4	19.1	30x2.0	36	2.28	57.9	2.01	51.1	3.88	98.6	NS	Y	Y	Y	Y
SG-DHFX90-1236	29220-1236	20822165	3/4	19.1	36x2.0	46	2.34	59.4	2.01	51.1	3.88	98.6	NS	Y	Y	Y	Y
SG-DHFX90-1642	29220-1642	20822163	1	25.4	42x2.0	50	3.11	79.0	2.99	75.9	5.27	133.9	NS	Y	Y	Y	Y

# DIN 24° Heavy

Male

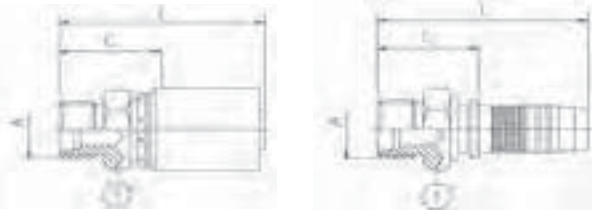

S=Skive  
NS=Non-Skive  
DG=Dual-Grip™

Descriptive #	Product #	SAP #	Hose Size ID		Thread Size (A)	Hex-1 Wrench Size	Cut-Off (C)		Length (L)		Skive Type	SR13, ARC13	SR15, ARC15	S4SP	S4SH
			in.	mm			mm	in.	mm	in.					
S6-DHM-1230	30225-1230	20424958	3/4	19.0	30x2.0	32	1.36	34.5	3.52	89.5	NS	Y			Y
DG-DHM-1236	16225-1236	20242327	3/4	19.0	36x2.0	36	1.14	29.0	3.90	99.0	DG	DGF1-12	DGF1-12	DGF1-12	DGF1-12
DG-DHM-1642	16225-1642	20242384	1	25.4	42x2.0	46	1.26	32.0	4.59	116.5	DG	DGF1-16	DGF1-16	DGF1-16	DGF1-16
S6-DHM-1642	30225-1642	20424959	1	25.4	42x2.0	46	1.59	40.5	4.11	104.5	NS	Y			Y

Descriptive #	Product #	SAP #	Hose Size ID		Thread Size (A)	Hex-1 Wrench Size	Cut-Off (C)		Length (L)		Skive Type	SR13, ARC13	SR15, ARC15	S4SP	S4SH
			in.	mm			mm	in.	mm	in.					
SG-DHM-0824	29225-0824	20822160	1/2	12.7	24x1.5	24	1.22	31.0	2.76	70.0	NS			Y	
SG-DHM-1230	29225-1230	20822159	3/4	19.1	30x2.0	32	1.44	36.5	3.31	84.0	NS	Y	Y	Y	Y
SG-DHM-1236	29225-1236	20822158	1	3/4	26x2.0	36	1.60	40.6	3.47	88.1	NS	Y	Y	Y	Y
SG-DHM-1642	29225-1642	20822157	1	25.4	42x2.0	46	1.82	46.2	4.10	104.2	NS	Y	Y	Y	Y

# Japanese Komatsu® 30° Flare with Metric Threads

Female | Swivel

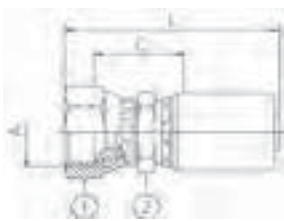

S=Skive  
NS=Non-Skive  
DG=Dual-Grip™

Descriptive #	Product #	SAP #	Hose Size ID		Thread Size	Hex-1 Wrench Size	Hex-2 Wrench Size	Cut-Off (C)		Length (L)		Skive Type	SR13, ARC13	SR15, ARC15	S4SP	S4SH
			in.	mm				mm	mm	in.	mm					
SG-KMFX-0618	29545-0618	20821982	3/8	9.5	18x1.5	22		1.36	34.6	2.82	71.6	NS			Y	
SG-KMFX-0822	29545-0822	20758298	1/2	12.7	22x1.5	27		1.47	37.3	3.00	76.3	NS			Y	
SG-KMFX-1024	29545-1024	20821981	5/8	15.9	24x1.5	32		1.75	44.5	3.35	85.0	NS			Y	
SG-KMFX-1230	29545-1230	20821980	3/4	19.1	30x1.5	36		1.95	49.5	3.82	97.0	NS	Y	Y	Y	Y
SG-KMFX-1633	29545-1633	20821979	1/2	12.7	33x1.5	41		2.43	61.8	4.72	119.8	NS	Y	Y	Y	Y

## Japanese Komatsu® 30° Flare with Metric Threads

Female | 45° Elbow | Swivel

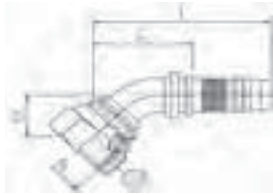

S=Skive  
NS=Non-Skive  
DG=Dual-Grip™

Descriptive #	Product #	SAP #	Hose Size ID		Thread Size (A)	Hex-1 Wrench Size	Drop (D)		Cut-Off (C)		Length (L)		Skive Type	SR13, ARC13	SR15, ARC15	S4SP	S4SH
			in.	mm			mm	in.	mm	in.	mm	in.					
SG-KMFX45-0618	29548-0618	20821978	3/8	9.5	18x1.5	22	0.71	18.0	1.73	43.9	3.19	80.9	NS			Y	
SG-KMFX45-0822	29548-0822	20821977	1/2	12.7	22X1.5	27	1.16	29.5	2.20	55.9	3.74	94.9	NS			Y	

## Japanese Komatsu® 30° Flare with Metric Threads

Female | 90° Elbow | Swivel

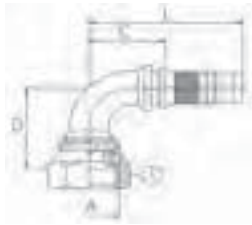

S=Skive  
NS=Non-Skive  
DG=Dual-Grip™

Descriptive #	Product #	SAP #	Hose Size ID		Thread Size (A)	Hex-1 Wrench Size	Drop (D)		Cut-Off (C)		Length (L)		Skive Type	SR13, ARC13	SR15, ARC15	S4SP	S4SH
			in.	mm			mm	in.	mm	in.	mm	in.					
SG-KMFX90-0618	29550-0618	20821976	3/8	9.5	18X1.5	22	1.40	35.6	1.42	36.1	2.88	73.1	NS			Y	
SG-KMFX90-0822	29550-0822	20821975	1/2	12.7	22X1.5	27	2.09	53.1	1.74	44.1	3.27	83.1	NS			Y	

## JIS 30° (Parallel Pipe Threads)

Female | Swivel



S=Skive  
NS=Non-Skive  
DG=Dual-Grip™

Descriptive #	Product #	SAP #	Hose Size ID		Thread Size	Hex-1 Wrench Size	Hex-2 Wrench Size	Cut-Off (C)		Length (L)		Skive Type	SR13, ARC13	SR15, ARC15	S4SP	S4SH
			in.	mm				mm	mm	in.	mm					
SG-JSFX-0606	29520-0606	20821992	3/8	9.5	3/8-19	22	19	1.36	34.6	2.82	71.6	NS			Y	
SG-JSFX-0808	29520-0808	20821991	1/2	12.7	1/2-14	27	22	1.47	37.2	3.00	76.3	NS			Y	
SG-JSFX-1212	29520-1212	20821990	3/4	19.0	3/4-14	36	30	1.70	43.1	3.57	90.6	NS	Y	Y	Y	Y
SG-JSFX-1616	29520-1616	20821989	1	25.4	1-11	41	36	2.05	52.1	4.33	110.1	NS	Y	Y	Y	Y

## How to Use the Fitting Tables

This section lists ALL fittings that are compatible with the following hoses:

Hose Family	Hose Description
SR3	SAE 100R3/EN 854 R3
HR4	SAE 100R4
SR6	SAE 100R6/EN 854 R6
HR6	SAE 100R6/EN 854 R6 (High Temp)
SR14A	SAE 100R14A

## Fitting Description

Fitting Type

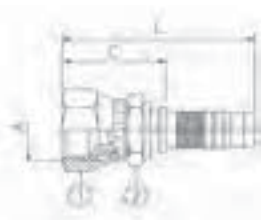

S=Skive  
NS=Non-Skive  
DG=Dual-Grip™

Descriptive #	Product #	SAP #	Hose Size ID		Thread Size (A)		Hex-1 Wrench Size		Hex-2 Wrench Size		Cut-Off (C)		Length (L)		Skive Type	SR3	SR6, HR4	SR14A
			in.	mm	in.	mm	in.	mm	in.	mm	in.	mm	in.	mm				
UC-SCFX-0304	36400-0304	20557173	3/16	4.8	7/16-20	9/16	14	1/2	12	0.71	18.1	1.93	49.0				UCF2-03	UCF9-03
UC-SCFX-04045	36400-0404	20242786	1/4	6.4	7/16-20	5/8	16	9/16	14	0.77	19.6	2.09	53.1		UCF6-04		UCF2-04	UCF9-04
UC-SCFX-0404	36400-0404S	20540685	1/4	6.4	7/16-20	5/8	16	9/16	14	0.77	19.6	2.09	53.1		Uni-Crimp Ferrule PN		UCF2-04	UCF9-04

Choose fittings carefully considering the working pressure of both hose and fitting. The maximum working pressure of the hose assembly is the lesser of the rated working pressure of the hose and the fitting. See page 300 for working pressure.

A **blank space** in the hose compatibility columns indicates that the fitting **DOES NOT** work for that particular hose.

A **Part Number (Ferrule)** in the hose compatibility columns indicates that the fitting is a **Uni-Crimp™** style. The fitting, along with the ferrule shown, work together as a unit for that particular hose.

# JIC 37° Flare (SAE J514)

Female | Swivel

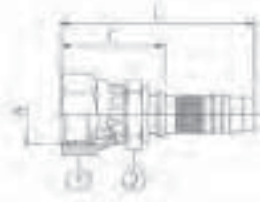

S=Skive  
NS=Non-Skive  
DG=Dual-Grip™

Descriptive #	Product #	SAP #	Hose Size ID		Thread Size (A)		Hex-1 Wrench Size		Hex-2 Wrench Size		Cut-Off (C)		Length (L)		Skive Type	SR3	HR4	SR6, HR6	SR14A
			in.	mm	in.	mm	in.	mm	in.	mm	in.	mm	in.	mm					
UCHJCFX-0304	36400-0304	20530659	3/16	4.8	7/16-20	9/16	14	1/2	12	1.07	27.2	1.94	49.4	NS			UCF2-03	UCF9-03	
UCJCFX-0403	36400-0403	20318324	1/4	6.4	3/8-24	1/2	12	1/2	12	1.11	28.1	2.09	53.0	NS	UCF6-04		UCF2-04	UCF9-04	
UCJCFX-0404	36400-0404	20242786	1/4	6.4	7/16-20	5/8	16	9/16	14	1.17	29.6	2.15	54.5	NS	UCF6-04		UCF2-04	UCF9-04	
UCJCFX-0404S	36400-0404S	20540685	1/4	6.4	7/16-20	5/8	16	9/16	14	1.17	29.6	2.15	54.5	NS	UCF6-04		UCF2-04	UCF9-04	
UCJCFX-0405	36400-0405	20242746	1/4	6.4	1/2-20	11/16	17	9/16	14	1.24	31.4	2.22	56.3	NS	UCF6-04		UCF2-04	UCF9-04	
UCJCFX-0406	36400-0406	20242778	1/4	6.4	9/16-18	3/4	19	9/16	14	1.23	31.2	2.21	56.1	NS	UCF6-04		UCF2-04	UCF9-04	
UCJCFX-0504	36400-0504	20629768	5/16	7.9	7/16-20	5/8	16	9/16	14	1.20	30.4	2.18	55.3	NS	UCF6-05		UCF2-05	UCF9-05	
UCJCFX-0505	36400-0505	20242676	5/16	7.9	1/2-20	11/16	17	9/16	14	1.24	31.4	2.22	56.3	NS	UCF6-05		UCF2-05	UCF9-05	
UCJCFX-0506	36400-0506	20242765	5/16	7.9	9/16-18	3/4	19	9/16	14	1.23	31.2	2.21	56.1	NS	UCF6-05		UCF2-05	UCF9-05	
UCJCFX-0604	36400-0604	20688966	3/8	9.5	7/16-20									NS	UCF6-06		UCF2-06	UCF9-06	
UCJCFX-0606	36400-0606	20242787	3/8	9.5	9/16-18	3/4	19	11/16	17	1.22	31.1	2.27	57.7	NS	UCF6-06		UCF2-06	UCF9-06	
UCJCFX-0606S	36400-0606S	20540686	3/8	9.5	9/16-18	3/4	19	11/16	17	1.22	31.1	2.27	57.7	NS	UCF6-06		UCF2-06	UCF9-06	
UCJCFX-0608	36400-0608	20242779	3/8	9.5	3/4-16	1	25	3/4	19	1.37	34.9	2.42	61.5	NS	UCF6-06		UCF2-06	UCF9-06	
UCJCFX-0610	36400-0610	20242708	3/8	9.5	7/8-14	1 1/8	27	7/8	22	1.53	38.8	2.58	65.5	NS	UCF6-06		UCF2-06	UCF9-06	
UCJCFX-0806	36400-0806	20242666	1/2	12.7	9/16-18	3/4	19	3/4	19	1.29	32.8	2.54	64.5	NS	UCF6-08		UCF2-08	UCF9-08	
UCJCFX-0808	36400-0808	20242785	1/2	12.7	3/4-16	1	25	3/4	19	1.44	36.7	2.69	68.4	NS	UCF6-08		UCF2-08	UCF9-08	
UCJCFX-0808S	36400-0808S	20540687	1/2	12.7	3/4-16	1	25	3/4	19	1.44	36.7	2.69	68.4	NS	UCF6-08		UCF2-08	UCF9-08	
UCJCFX-0810	36400-0810	20242772	1/2	12.7	7/8-14	1 1/8	27	7/8	22	1.56	39.6	2.81	71.3	NS	UCF6-08		UCF2-08	UCF9-08	
UCJCFX-0812	36400-0812	20242727	1/2	12.7	1 1/8-12	1 1/4	32	1	25	1.68	42.6	2.93	74.3	NS	UCF6-08		UCF2-08	UCF9-08	
UCJCFX-1008	36400-1008	20242399	5/8	15.9	3/4-16	1	25	15/16	24	1.52	38.7	2.88	73.2	NS	UCF6-10		UCF2-10	UCF9-10	
UCJCFX-1010	36400-1010	20242774	5/8	15.9	7/8-14	1 1/8	27	15/16	24	1.67	42.4	3.03	76.9	NS	UCF6-10		UCF2-10	UCF9-10	
UCJCFX-1010S	36400-1010S	20540688	5/8	15.9	7/8-14	1 1/8	27	15/16	24	1.67	42.4	3.03	76.9	NS	UCF6-10		UCF2-10	UCF9-10	
UCJCFX-1012	36400-1012	20242580	5/8	15.9	1 1/8-12	1 1/4	32	1	25	1.68	42.6	3.04	77.1	NS	UCF6-10		UCF2-10	UCF9-10	
UCJCFX-1210	36400-1210	20242694	3/4	19.0	7/8-14	1 1/4	32	1 1/8	27	1.63	41.4	3.18	80.8	NS	UCF6-12	UCF6-12	UCF2-12	UCF9-12	
UCJCFX-1212	36400-1212	20242783	3/4	19.0	1 1/8-12	1 1/4	32	1 1/8	27	1.74	44.2	3.29	83.6	NS	UCF6-12	UCF6-12	UCF2-12	UCF9-12	
UCJCFX-1212S	36400-1212S	20540689	3/4	19.0	1 1/8-12	1 1/4	32	1 1/8	27	1.74	44.2	3.29	83.6	NS	UCF6-12	UCF6-12	UCF2-12	UCF9-12	
UCJCFX-1214	36400-1214	20242613	3/4	19.0	1 3/8-12	1 3/8	36	1 1/4	32	1.76	44.6	3.31	84.0	NS	UCF6-12	UCF6-12	UCF2-12	UCF9-12	
UCJCFX-1216	36400-1216	20242719	3/4	19.0	1 5/8-12	1 1/2	38	1 1/4	32	1.89	48.1	3.45	87.5	NS	UCF6-12	UCF6-12	UCF2-12	UCF9-12	
UCJCFX-1612	36400-1612	20242702	1	25.4	1 1/8-12	1 1/4	32	1 1/4	32	1.88	47.7	3.65	92.8	NS	UCF6-16	UCF6-16		UCF9-16	
UCJCFX-1616	36400-1616	20242784	1	25.4	1 3/8-12	1 1/2	38	1 1/4	32	1.96	49.8	3.74	94.9	NS	UCF6-16	UCF6-16		UCF9-16	
UCJCFX-1616S	36400-1616S	20540690	1	25.4	1 3/8-12	1 1/2	38	1 1/4	32	1.96	49.8	3.74	94.9	NS	UCF6-16	UCF6-16		UCF9-16	
UCJCFX-1620 <sup>T</sup>	36400-1620	20242711	1	25.4	1 5/8-12	2	50	1 3/8	41	2.07	52.5	3.84	97.6	NS	UCF6-16	UCF6-16		UCF9-16	
UCJCFX-2020 <sup>T</sup>	36400-2020	20242781	1 1/4	31.8	1 3/8-12	2	50	1 3/8	41	2.15	54.6	4.20	106.6	NS		UCF6-20			
UCJCFX-2020S	36400-2020S	20676944	1 1/4	31.8	1 3/8-12	2	50	1 3/8		2.15	54.6	4.20	106.6	NS		UCF6-20			
UCJCFX-2420	36400-2420	20591960	1 1/2	38.1	1 3/8-12	2	50	2	50	2.21	56.2	4.54	115.4	NS		UCF6-24			
UCJCFX-2424 <sup>T</sup>	36400-2424	20242768	1 1/2	38.1	1 7/8-12	2 3/8	55	2	50	2.42	61.4	4.75	120.6	NS		UCF6-24			
UCJCFX-3232 <sup>T</sup>	36400-3232	20242754	2	50.8	2 1/2-12	2 3/4	70	2 3/8	65	2.88	73.1	5.71	145.1	NS		UCF6-32			
UCJCFX-3232S	36400-3232S	20672343	2	50.8	2 1/2-12	2 3/4	70	2 3/8	65	2.88	73.1	5.71	145.1	NS		UCF6-32			

T: Thrust-Wire Nut (see "Fitting Identification" in Appendix for details)

S: Stainless Steel

# JIC 37° Flare (SAE J514)

Female | 45° Elbow | Swivel

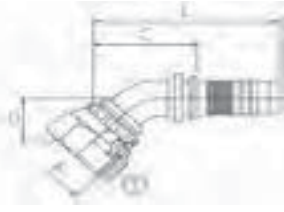

S=Skive  
NS=Non-Skive  
DG=Dual-Grip™

Descriptive #	Product #	SAP #	Hose Size ID		Thread Size (A)		Hex-1 Wrench Size		Drop (D)		Cut-Off (C)		Length (L)		Skive Type	SR3	HR4	SR6, HR6	SR14A
			in.	mm	in.	mm	in.	mm	in.	mm	in.	mm	in.	mm					
UC-JCFX45-0304	36420-0304	20685771	3/16	4.8	7/16-20	5/8	16	0.39	10.0	1.44	36.6	2.31	58.8	NS			UCF2-04	UCF9-03	
UC-JCFX45-0404	36420-0404	20242725	1/4	6.4	7/16-20	5/8	16	0.39	10.0	1.46	37.0	2.44	61.9	NS	UCF6-04		UCF2-04	UCF9-04	
UC-JCFX45-0405	36420-0405	20242628	1/4	6.4	1/2-20	11/16	17	0.47	12.0	1.46	37.0	2.44	61.9	NS	UCF6-04		UCF2-04	UCF9-04	
UC-JCFX45-0406	36420-0406	20242629	1/4	6.4	9/16-18	3/4	19	0.43	11.0	1.54	39.0	2.52	63.9	NS	UCF6-04		UCF2-04	UCF9-04	
UC-JCFX45-0506	36420-0506	20242489	5/16	7.9	9/16-18	3/4	19	0.47	11.9	1.69	42.9	2.67	67.8	NS	UCF6-05		UCF2-05	UCF9-05	
UC-JCFX45-0606	36420-0606	20242743	3/8	9.5	9/16-18	3/4	19	0.43	11.0	1.81	46.0	2.86	72.6	NS	UCF6-06		UCF2-06	UCF9-06	
UC-JCFX45-0608	36420-0608	20242698	3/8	9.5	3/4-16	1	25	0.59	15.0	1.85	47.0	2.90	73.6	NS	UCF6-06		UCF2-06	UCF9-06	
UC-JCFX45-0808	36420-0808	20242729	1/2	12.7	3/4-16	1	25	0.59	15.0	2.05	52.0	3.29	83.7	NS	UCF6-08		UCF2-08	UCF9-08	
UC-JCFX45-0810	36420-0810	20242675	1/2	12.7	7/8-14	1 1/16	27	0.63	16.0	2.01	51.0	3.26	82.7	NS	UCF6-08		UCF2-08	UCF9-08	
UC-JCFX45-1010	36420-1010	20242345	5/8	15.9	7/8-14	1 1/16	27	0.87	22.0	2.56	65.0	3.92	99.5	NS	UCF6-10		UCF2-10	UCF9-10	
UC-JCFX45-1012	36420-1012	20242344	5/8	15.9	1 1/16-12	1 1/4	32	0.83	21.0	2.72	69.0	4.07	103.5	NS	UCF6-10		UCF2-10	UCF9-10	
UC-JCFX45-1212	36420-1212	20242721	3/4	19.0	1 1/16-12	1 1/4	32	0.83	21.0	2.64	67.0	4.19	106.5	NS	UCF6-12	UCF6-12	UCF2-12	UCF9-12	
UC-JCFX45-1216	36420-1216	20242343	3/4	19.0	1 5/16-12	1 1/2	38	1.02	26.0	2.80	71.0	4.35	110.4	NS	UCF6-12	UCF6-12	UCF2-12	UCF9-12	
UC-JCFX45-1616	36420-1616	20242742	1	25.4	1 5/16-12	1 1/2	38	0.95	24.0	3.11	79.0	4.89	124.1	NS	UCF6-16	UCF6-16		UCF9-16	
UC-JCFX45-2020 <sup>T</sup>	36420-2020	20242710	1 1/4	31.8	1 5/8-12	2	50	1.46	37.1	3.82	97.0	5.87	149.0	NS		UCF6-20			
UC-JCFX45-2424 <sup>T</sup>	36420-2424	20242632	1 1/2	38.1	1 7/8-12	2 3/16	55	1.69	42.9	4.45	113.0	6.78	172.2	NS		UCF6-24			
UC-JCFX45-3232 <sup>T</sup>	36420-3232	20269237	2	50.8	2 1/2-12	2 3/4	70	2.64	67.1	6.30	160.0	9.13	232.0	NS		UCF6-32			

T: Thrust-Wire Nut (see "Fitting Identification" in Appendix for details)



# JIC 37° Flare (SAE J514)

Female | 90° Elbow | Swivel

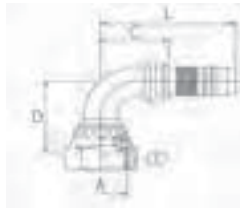

Elbow Type:  
LT=Long Tube  
ST=Short Tube

S=Skive  
NS=Non-Skive  
DG=Dual-Grip™

Descriptive #	Product #	SAP #	Hose Size ID		Thread Size (A)		Hex-1 Wrench Size		Elbow Type		Drop (D)		Cut-Off (C)		Length (L)		Skive Type		SR3	HR4	SR6, HR6	SR14A
			in.	mm	in.	mm	in.	mm	in.	mm	in.	mm	in.	mm	in.	mm	SR5	HR5				
UCJCFX90-0304	36425-0304	20269250	3/16	4.8	7/16-20	5/8	16				1.26	32.0	1.30	33.0	2.17	55.2	NS				UCF2-03	UCF9-03
UCJCFX90-0404	36425-0404	20242770	1/4	6.4	7/16-20	5/8	16				1.26	32.0	1.34	34.0	2.32	58.9	NS	UCF6-04			UCF2-04	UCF9-04
UCJCFX90L-0404	36440-0404	20242662	1/4	6.4	7/16-20	5/8	16	LT			1.81	46.0	1.25	31.8	2.23	56.7	NS	UCF6-04			UCF2-04	UCF9-04
UCJCFX90S-0404	36445-0404	20242430	1/4	6.4	7/16-20	5/8	16	ST			0.83	21.0	1.06	27.0	2.04	51.9	NS	UCF6-04			UCF2-04	UCF9-04
UCJCFX90-0405	36425-0405	20242657	1/4	6.4	1/2-20	11/16	17				1.18	30.0	1.02	26.0	2.00	50.9	NS	UCF6-04			UCF2-04	UCF9-04
UCJCFX90L-0405	36440-0405	20242473	1/4	6.4	1/2-20	11/16	17	LT			1.77	45.0	1.02	26.0	2.00	50.9	NS	UCF6-04			UCF2-04	UCF9-04
UCJCFX90S-0405	36445-0405	20242396	1/4	6.4	1/2-20	11/16	17	ST			0.93	23.5	1.02	26.0	2.00	50.9	NS	UCF6-04			UCF2-04	UCF9-04
UCJCFX90-0406	36425-0406	20242718	1/4	6.4	9/16-18	3/4	19				1.50	38.0	1.10	28.0	2.08	52.9	NS	UCF6-04			UCF2-04	UCF9-04
UCJCFX90L-0406	36440-0406	20242474	1/4	6.4	9/16-18	3/4	19	LT			2.13	54.0	1.34	34.0	2.32	58.9	NS	UCF6-04			UCF2-04	UCF9-04
UCJCFX90S-0406	36445-0406	20242397	1/4	6.4	9/16-18	3/4	19	ST			0.91	23.0	1.22	31.0	2.20	55.9	NS	UCF6-04			UCF2-04	UCF9-04
UCJCFX90-0504	36425-0504	20612476	5/16	7.9	7/16-20	5/8	16				1.26	32.0	1.34	34.0	2.32	58.9	NS	UCF6-05			UCF2-05	UCF9-05
UCJCFX90-0505	36425-0505	20242565	5/16	7.9	1/2-20	3/4	17				1.38	35.1	1.34	34.0	2.32	58.9	NS	UCF6-05			UCF2-05	UCF9-05
UCJCFX90-0506	36425-0506	20242490	5/16	7.9	9/16-18	3/4	19				1.38	35.1	1.30	33.0	2.28	57.9	NS	UCF6-05			UCF2-05	UCF9-05
UCJCFX90L-0506	36440-0506	20242454	5/16	7.9	9/16-18	3/4	19	LT			2.13	54.1	1.42	36.1	2.40	61.0	NS	UCF6-05			UCF2-05	UCF9-05
UCJCFX90-0604	36425-0604	20318323	3/8	9.5	7/16-20	5/8	16				1.26	32.0	1.38	35.0	2.43	61.6	NS	UCF6-06			UCF2-06	UCF9-06
UCJCFX90L-0604	36440-0604	20318322	3/8	9.5	7/16-20	5/8	16	LT			1.81	46.0	1.22	31.0	2.27	57.6	NS	UCF6-06			UCF2-06	UCF9-06
UCJCFX90-0606	36425-0606	20242776	3/8	9.5	9/16-18	3/4	19				1.38	35.0	1.22	31.0	2.27	57.6	NS	UCF6-06			UCF2-06	UCF9-06
UCJCFX90L-0606	36440-0606	20242720	3/8	9.5	9/16-18	3/4	19	LT			2.13	54.0	1.69	43.0	2.74	69.6	NS	UCF6-06			UCF2-06	UCF9-06
UCJCFX90S-0606	36445-0606	20242475	3/8	9.5	9/16-18	3/4	19	ST			0.91	23.0	1.65	42.0	2.70	68.7	NS	UCF6-06			UCF2-06	UCF9-06
UCJCFX90-0608	36425-0608	20242753	3/8	9.5	3/4-16	1	25				1.61	41.0	1.54	39.0	2.58	65.6	NS	UCF6-06			UCF2-06	UCF9-06
UCJCFX90L-0608	36440-0608	20242587	3/8	9.5	3/4-16	1	25	LT			2.52	64.0	1.85	47.0	2.90	73.6	NS	UCF6-06			UCF2-06	UCF9-06
UCJCFX90S-0608	36445-0608	20242431	3/8	9.5	3/4-16	1	25	ST			1.14	29.0	1.93	49.0	2.98	75.6	NS	UCF6-06			UCF2-06	UCF9-06
UCJCFX90-0808	36425-0808	20242764	1/2	12.7	3/4-16	1	25				1.58	40.0	1.46	37.0	2.70	68.7	NS	UCF6-08			UCF2-08	UCF9-08
UCJCFX90L-0808	36440-0808	20242688	1/2	12.7	3/4-16	1	25	LT			2.52	64.0	1.97	50.0	3.22	81.7	NS	UCF6-08			UCF2-08	UCF9-08
UCJCFX90S-0808	36445-0808	20242429	1/2	12.7	3/4-16	1	25	ST			1.14	29.0	1.81	46.0	3.06	77.7	NS	UCF6-08			UCF2-08	UCF9-08
UCJCFX90-0810	36425-0810	20242706	1/2	12.7	7/8-14	1 1/16	27				1.85	47.0	1.69	43.0	2.94	74.7	NS	UCF6-08			UCF2-08	UCF9-08
UCJCFX90L-0810	36440-0810	20242584	1/2	12.7	7/8-14	1 1/16	27	LT			2.56	65.0	1.46	37.0	2.70	68.7	NS	UCF6-08			UCF2-08	UCF9-08
UCJCFX90S-0810	36445-0810	20242395	1/2	12.7	7/8-14	1 1/16	27	ST			1.26	32.0	1.81	46.0	3.06	77.7	NS	UCF6-08			UCF2-08	UCF9-08
UCJCFX90-0812	36425-0812	20242349	1/2	12.7	1 1/16-12	1 1/4	32				1.81	46.0	1.46	37.0	2.70	68.7	NS	UCF6-08			UCF2-08	UCF9-08
UCJCFX90-1010	36425-1010	20242749	5/8	15.9	7/8-14	1 1/16	27				1.89	48.0	1.93	49.0	3.29	83.5	NS	UCF6-10			UCF2-10	UCF9-10
UCJCFX90L-1010	36440-1010	20242346	5/8	15.9	7/8-14	1 1/16	27	LT			2.56	65.0	1.97	50.0	3.32	84.4	NS	UCF6-10			UCF2-10	UCF9-10
UCJCFX90S-1010	36445-1010	20591962	5/8	15.9	7/8-14	1 1/16	27	ST									NS	UCF6-10			UCF2-10	UCF9-10
UCJCFX90-1012	36425-1012	20242350	5/8	15.9	1 1/16-12	1 1/4	32				2.28	58.0	1.89	48.0	3.25	82.5	NS	UCF6-10			UCF2-10	UCF9-10
UCJCFX90L-1012	36440-1012	20283400	5/8	15.9	1 1/16-12	1 1/4	32	LT									NS	UCF6-10			UCF2-10	UCF9-10
UCJCFX90L-1210	36440-1210	20591961	3/4	19.0	7/8-14	1 1/16	27	LT			2.76	70.0	1.97	50.0	3.52	89.5	NS	UCF6-12	UCF6-12		UCF2-12	UCF9-12
UCJCFX90S-1210	36445-1210	20613762	3/4	19.0	7/8-14	1 1/16	27	ST									NS	UCF6-12	UCF6-12		UCF2-12	UCF9-12
UCJCFX90-1212	36425-1212	20242756	3/4	19.0	1 1/16-12	1 1/4	32				2.13	54.0	2.05	52.0	3.60	91.4	NS	UCF6-12	UCF6-12		UCF2-12	UCF9-12
UCJCFX90L-1212	36440-1212	20242674	3/4	19.0	1 1/16-12	1 1/4	32	LT			3.74	95.0	2.13	54.0	3.68	93.4	NS	UCF6-12	UCF6-12		UCF2-12	UCF9-12
UCJCFX90S-1212	36445-1212	20591963	3/4	19.0	1 1/16-12	1 1/4	32	ST			1.81	46.0	2.28	58.0	3.84	97.4	NS	UCF6-12	UCF6-12		UCF2-12	UCF9-12
UCJCFX90-1216	36425-1216	20242579	3/4	19.0	1 1/16-12	1 1/2	38				2.84	72.0	2.09	53.0	3.64	92.5	NS	UCF6-12	UCF6-12		UCF2-12	UCF9-12
UCJCFX90-1616	36425-1616	20242758	1	25.4	1 1/16-12	1 1/2	38				2.81	71.4	2.89	73.4	4.67	118.5	NS	UCF6-16	UCF6-16			UCF9-16
UCJCFX90L-1616	36440-1616	20242651	1	25.4	1 1/16-12	1 1/2	38	LT			4.49	114.0	3.11	79.0	4.89	124.1	NS	UCF6-16	UCF6-16			UCF9-16
UCJCFX90S-1616	36445-1616	20591964	1	25.4	1 1/16-12	1 1/2	38	ST			2.21	56.0	2.91	74.0	4.69	119.1	NS	UCF6-16	UCF6-16			UCF9-16
UCJCFX90-2020 <sup>T</sup>	36425-2020	20242752	1 1/4	31.8	1 1/8-12	2	50				3.07	78.0	3.23	82.0	5.28	134.0	NS				UCF6-20	
UCJCFX90S-2020 <sup>T</sup>	36445-2020	20591967	1 1/4	31.8	1 1/8-12	2	50	ST			2.52	64.0	3.23	82.0	5.28	134.0	NS				UCF6-20	
UCJCFX90-2424 <sup>T</sup>	36425-2424	20242645	1 1/2	38.1	1 1/8-12	2 3/16	55				3.62	91.9	3.94	100.0	6.27	159.1	NS				UCF6-24	
UCJCFX90-3232 <sup>T</sup>	36425-3232	20269239	2	50.8	2 1/2-12	2 3/4	70				5.51	140.0	5.08	129.0	7.91	201.0	NS				UCF6-32	

T: Thrust-Wire Nut (see "Fitting Identification" in Appendix for details)

# JIC 37° Flare (SAE J514)

Male

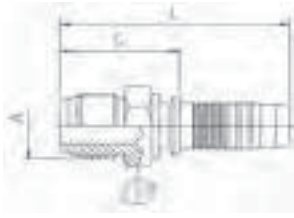

S=Skive  
NS=Non-Skive  
DG=Dual-Grip™

Descriptive #	Product #	SAP #	Hose Size ID		Thread Size (A)		Hex-1 Wrench Size		Cut-Off (C)		Length (L)		Skive Type	SR3	HR4	SR6, HR6	SR14A
			in.	mm	in.	mm	in.	mm	in.	mm	in.	mm					
UC-JCM-0304	36450-0304	20592795	3/16	4.8	7/16-20	1/2	12	0.98	24.8	1.85	47.0					UCF2-04	UCF9-04
UC-JCM-0404	36450-0404	20242728	1/4	6.4	7/16-20	1/2	12	0.99	25.2	1.97	50.1	NS	UCF6-04			UCF2-04	UCF9-04
UC-JCM-0405	36450-0405	20242664	1/4	6.4	1/2-20	9/16	14	1.03	26.2	2.01	51.1	NS	UCF6-04			UCF2-04	UCF9-04
UC-JCM-0406	36450-0406	20242687	1/4	6.4	9/16-18	11/16	17	1.04	26.4	2.02	51.3	NS	UCF6-04			UCF2-04	UCF9-04
UC-JCM-0505	36450-0505	20242588	5/16	7.9	1/2-20	9/16	14	1.04	26.3	2.02	51.2	NS	UCF6-05			UCF2-05	UCF9-05
UC-JCM-0506	36450-0506	20242434	5/16	7.9	9/16-18	11/16	17	1.04	26.5	2.02	51.4	NS	UCF6-05			UCF2-05	UCF9-05
UC-JCM-0606	36450-0606	20242759	3/8	9.5	9/16-18	11/16	17	1.05	26.6	2.10	53.2	NS	UCF6-06			UCF2-06	UCF9-06
UC-JCM-0608	36450-0608	20242755	3/8	9.5	3/4-16	3/4	19	1.14	28.9	2.19	55.5	NS	UCF6-06			UCF2-06	UCF9-06
UC-JCM-0610	36450-0610	20242630	3/8	9.5	7/8-14	15/16	24	1.33	33.8	2.38	60.5	NS	UCF6-06			UCF2-06	UCF9-06
UC-JCM-0808	36450-0808	20242736	1/2	12.7	3/4-16	3/4	19	1.17	29.8	2.42	61.4	NS	UCF6-08			UCF2-08	UCF9-08
UC-JCM-0810	36450-0810	20242716	1/2	12.7	7/8-14	15/16	24	1.35	34.4	2.60	66.0	NS	UCF6-08			UCF2-08	UCF9-08
UC-JCM-0812	36450-0812	20242670	1/2	12.7	1 1/16-12	1 1/16	27	1.46	37.1	2.71	68.7	NS	UCF6-08			UCF2-08	UCF9-08
UC-JCM-1010	36450-1010	20242435	5/8	15.9	7/8-14	15/16	24	1.38	35.0	2.73	69.4	NS	UCF6-10			UCF2-10	UCF9-10
UC-JCM-1012	36450-1012	20242400	5/8	15.9	1 1/16-12	1 1/16	27	1.46	37.1	2.82	71.5	NS	UCF6-10			UCF2-10	UCF9-10
UC-JCM-1212	36450-1212	20242732	3/4	19.0	1 1/16-12	1 1/16	27	1.48	37.7	3.04	77.1	NS	UCF6-12	UCF6-12		UCF2-12	UCF9-12
UC-JCM-1214	36450-1214	20242542	3/4	19.0	1 3/16-12	1 1/4	32	1.62	41.0	3.17	80.5	NS	UCF6-12	UCF6-12		UCF2-12	UCF9-12
UC-JCM-1216	36450-1216	20242634	3/4	19.0	1 5/16-12	1 7/16	36	1.66	42.2	3.21	81.6	NS	UCF6-12	UCF6-12		UCF2-12	UCF9-12
UC-JCM-1616	36450-1616	20242747	1	25.4	1 5/16-12	1 7/16	36	1.67	42.4	3.45	87.5	NS	UCF6-16	UCF6-16			UCF9-16
UC-JCM-1620	36450-1620	20242433	1	25.4	1 5/8-12	1 9/16	46	1.84	46.8	3.62	91.9	NS	UCF6-16	UCF6-16			UCF9-16
UC-JCM-2020	36450-2020	20242712	1 1/4	31.8	1 5/8-12	1 9/16	46	1.91	48.6	3.96	100.5	NS		UCF6-20			
UC-JCM-2024	36450-2024	20242608	1 1/4	31.8	1 7/8-12	2	50	2.08	52.8	4.12	104.7	NS		UCF6-20			
UC-JCM-2424	36450-2424	20242625	1 1/2	38.1	1 7/8-12	2	50	2.08	52.7	4.40	111.8	NS		UCF6-24			
UC-JCM-3232	36450-3232	20242547	2	50.8	2 1/2-12	2 9/16	65	2.45	62.1	5.28	134.1	NS		UCF6-32			

# SAE 45° Flare (J512)

Female | Swivel

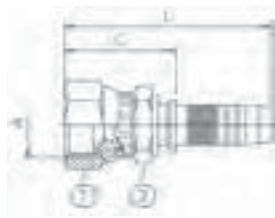

S=Skive  
NS=Non-Skive  
DG=Dual-Grip™

Descriptive #	Product #	SAP #	Hose Size ID		Thread Size (A)		Hex-1 Wrench Size		Hex-2 Wrench Size		Cut-Off (C)		Length (L)		Skive Type	SR3	HR4	SR6, HR6	SR14A
			in.	mm	in.	mm	in.	mm	in.	mm	in.	mm	in.	mm					
UC-SFFX-0304	36775-0304	20778888	3/16	4.8	7/16-20	5/8	16	1/2	13	1.07	27.2	1.94	49.4	NS				UCF2-03	UCF9-03
UC-SFFX-0606	36775-0606	20242760	3/8	9.5	5/8-18	7/8	22	3/4	19	1.32	33.6	2.37	60.2	NS	UCF6-06			UCF2-06	UCF9-06
UC-SFFX-0608	36775-0608	20318359	3/8	9.5	3/4-16	1	25	3/4	19	1.37	34.9	2.42	61.5	NS	UCF6-06			UCF2-06	UCF9-06
UC-SFFX-0808	36775-0808	20778907	1/2	12.7	3/4-16	1	25	7/8	22	1.44	36.7	2.69	68.4	NS	UCF6-08			UCF2-08	UCF9-08
UC-SFFX-0810	36775-0810	20778908	1/2	12.7	7/8-14	1 1/16	27	7/8	22	1.60	40.6	2.85	72.3	NS	UCF6-08			UCF2-08	UCF9-08
UC-SFFX-1212	36775-1212	20242652	3/4	19.0	1 1/16-14	1 1/4	32	1 1/16	27	1.74	44.2	3.29	83.6	NS	UCF6-12	UCF6-12		UCF2-12	UCF9-12

## SAE 45° Flare (J512)

Female | 45° Elbow | Swivel

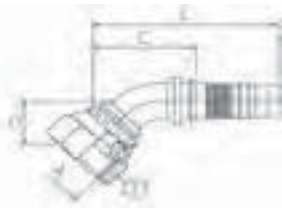

S=Skive  
NS=Non-Skive  
DG=Dual-Grip™

Descriptive #	Product #	SAP #	Hose Size ID		Thread Size (A)		Hex-1 Wrench Size		Drop (D)		Cut-Off (C)		Length (L)		Skive Type		SR3	HR4	SR6, HR6	SR14A
			in.	mm	in.	mm	in.	mm	in.	mm	in.	mm	in.	mm	NS	DG				
UC-SFFX45-0506	36777-0506	20778900	5/16	7.9	5/8-18	7/8	22	0.47	11.9	1.69	42.9	2.67	67.8	NS	UCF6-05	UCF2-05	UCF9-05			
UC-SFFX45-0606	36777-0606	20318360	3/8	9.5	5/8-18	7/8	22	0.47	11.9	1.81	46	2.86	72.6	NS	UCF6-06	UCF2-06	UCF9-06			
UC-SFFX45-0608	36777-0608	20778909	3/8	9.5	3/4-16	1	25	0.59	15.0	1.85	47	2.90	73.6	NS	UCF6-06	UCF2-06	UCF9-06			
UC-SFFX45-0808	36777-0808	20318361	1/2	12.7	3/4-16	1	25	0.59	15.0	2.05	52	3.29	83.7	NS	UCF6-08	UCF2-08	UCF9-08			
UC-SFFX45-0810	36777-0810	20778901	1/2	12.7	7/8-14	1 1/16	27	0.63	16.0	2.00	51	3.30	83.0	NS	UCF6-08	UCF2-08	UCF9-08			

## SAE 45° Flare (J512)

Female | 90° Elbow | Swivel

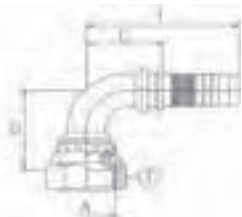

S=Skive  
NS=Non-Skive  
DG=Dual-Grip™

Descriptive #	Product #	SAP #	Hose Size ID		Thread Size (A)		Hex-1 Wrench Size		Drop (D)		Cut-Off (C)		Length (L)		Skive Type		SR3	HR4	SR6, HR6	SR14A
			in.	mm	in.	mm	in.	mm	in.	mm	in.	mm	in.	mm	NS	DG				
UC-SFFX90-0506	36780-0506	20778902	5/16	7.9	5/8-18	7/8	22	1.38	35.1	1.30	33.0	2.28	57.9	NS	UCF6-05	UCF2-05	UCF9-05			
UC-SFFX90-0606	36780-0606	20318325	3/8	9.5	5/8-18	7/8	22	0.95	24.0	1.65	42.0	2.70	68.7	NS	UCF6-06	UCF2-06	UCF9-06			
UC-SFFX90L-0606	36781-0606	20318362	3/8	9.5	5/8-18	7/8	22	2.19	55.5	1.69	43.0	2.74	69.6	NS	UCF6-06	UCF2-06	UCF9-06			
UC-SFFX90-0608	36781-0608	20761705	3/8	9.5	3/4-16	1	25	1.61	41.0	1.54	39.0	2.58	65.6	NS	UCF6-06	UCF2-06	UCF9-06			
UC-SFFX90S-0608	36783-0608	20778910	3/8	9.5	3/4-16	1	25	1.14	29.0	1.93	49.0	2.98	75.6	NS	UCF6-06	UCF2-06	UCF9-06			
UC-SFFX90-0808	36781-0808	20778903	1/2	12.7	3/4-16	1	25	1.58	40.0	1.46	37.0	2.70	68.7	NS	UCF6-08	UCF2-08	UCF9-08			
UC-SFFX90S-0808	36783-0808	20318363	1/2	12.7	3/4-16	1	25	1.14	29.0	1.81	46.0	3.06	77.7	NS	UCF6-08	UCF2-08	UCF9-08			
UC-SFFX90-0810	36781-0810	20778904	1/2	12.7	7/8-14	1 1/16	27	2.13	54.0	2.05	52.0	3.60	91.4	NS	UCF6-08	UCF2-08	UCF9-08			
UC-SFFX90S-0810	36783-0810	20778905	1/2	12.7	7/8-14	1 1/16	27	1.26	32.0	1.81	46.0	3.06	77.7	NS	UCF6-08	UCF2-08	UCF9-08			

## SAE 45° Flare (J512)

Male



S=Skive  
NS=Non-Skive  
DG=Dual-Grip™

Descriptive #	Product #	SAP #	Hose Size ID		Thread Size (A)		Hex-1 Wrench Size		Cut-Off (C)		Length (L)		Skive Type		SR3	HR4	SR6, HR6	SR14A
			in.	mm	in.	mm	in.	mm	in.	mm	in.	mm	NS	DG				
UC-SFM-0606	36785-0606	20318320	3/8	9.5	5/8-18	5/8	16	1.12	28.5	2.17	55.2	NS	UCF6-06	UCF2-06	UCF9-06			
UC-SFM-0608	36785-0810	20778911	3/8	9.5	3/4-16	3/4	19	1.23	31.2	2.28	57.9	NS	UCF6-06	UCF2-06	UCF9-06			
UC-SFM-0808	36785-0808	20778906	1/2	12.7	3/4-16	3/4	19	1.27	32.1	2.51	63.8	NS	UCF6-08	UCF2-08	UCF9-08			

# SAE 45° Inverted Flare

Male | Swivel

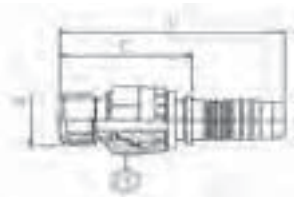

S=Skive  
NS=Non-Skive  
DG=Dual-Grip™

Descriptive #	Product #	SAP #	Hose Size ID		Thread Size (A)		Hex-1 Wrench Size		Cut-Off (C)		Length (L)		Skive Type	SR3	HR4	SR6, HR6	SR14A
			in.	mm	in.	mm	in.	mm	in.	mm	in.	mm					
UC-SIMX-0403	36800-0403	20318328	1/4	6.4	3/8-24	1/2	12	1.68	42.7	2.66	67.6	NS	UCF6-04		UCF2-04	UCF9-04	
UC-SIMX-0404	36800-0404	20318329	1/4	6.4	7/16-24	1/2	12	1.70	43.1	2.68	67.9	NS	UCF6-04		UCF2-04	UCF9-04	
UC-SIMX-0405	36800-0405	20318330	1/4	6.4	1/2-20	9/16	14	1.83	46.6	2.81	71.5	NS	UCF6-04		UCF2-04	UCF9-04	
UC-SIMX-0605	36800-0605	20318331	3/8	9.5	1/2-20	9/16	14	1.84	46.8	2.89	73.4	NS	UCF6-06		UCF2-06	UCF9-06	
UC-SIMX-0606	36800-0606	20318332	3/8	9.5	5/8-18	11/16	17	1.89	48.0	2.94	74.7	NS	UCF6-06		UCF2-06	UCF9-06	
UC-SIMX-0607	36800-0607	20318333	3/8	9.5	11/16-18	3/4	19	1.92	48.7	2.97	75.3	NS	UCF6-06		UCF2-06	UCF9-06	
UC-SIMX-0808	36800-0808	20318334	1/2	12.7	3/4-18	3/4	19	2.00	50.8	3.25	82.5	NS	UCF6-08		UCF2-08	UCF9-08	
UC-SIMX-0810	36800-0810	20318335	1/2	12.7	7/8-18	15/16	24	2.07	52.7	3.32	84.4	NS	UCF6-08		UCF2-08	UCF9-08	

# SAE 45° Inverted Flare

Male | 45° Elbow | Swivel

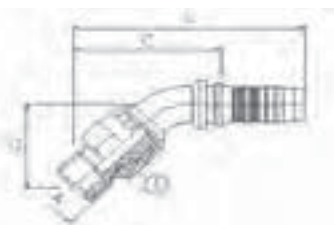

S=Skive  
NS=Non-Skive  
DG=Dual-Grip™

Descriptive #	Product #	SAP #	Hose Size ID		Thread Size (A)		Hex-1 Wrench Size		Drop (D)		Cut-Off (C)		Length (L)		Skive Type	SR3	HR4	SR6, HR6	SR14A
			in.	mm	in.	mm	in.	mm	in.	mm	in.	mm	in.	mm					
UC-SIMX45-0403	36810-0403	20318336	1/4	6.4	3/8-24	1/2	12	1.24	31.5	2.68	68.1	3.66	93.0	NS	UCF6-04		UCF2-04	UCF9-04	
UC-SIMX45-0404	36810-0404	20318337	1/4	6.4	7/16-24	1/2	12	1.24	31.5	2.68	68.1	3.66	93.0	NS	UCF6-04		UCF2-04	UCF9-04	
UC-SIMX45-0604	36810-0604	20318338	3/8	9.5	7/16-24	1/2	12	1.57	39.9	2.95	74.9	4.00	101.6	NS	UCF6-06		UCF2-06	UCF9-06	
UC-SIMX45-0605	36810-0605	20318339	3/8	9.5	1/2-20	9/16	14	1.50	38.1	2.99	75.9	4.04	102.6	NS	UCF6-06		UCF2-06	UCF9-06	
UC-SIMX45-0606	36810-0606	20318340	3/8	9.5	5/8-18	11/16	17	1.50	38.1	2.99	75.9	4.04	102.6	NS	UCF6-06		UCF2-06	UCF9-06	
UC-SIMX45-0607	36810-0607	20318341	3/8	9.5	11/16-18	3/4	19	1.50	38.1	2.99	75.9	4.04	102.6	NS	UCF6-06		UCF2-06	UCF9-06	

# SAE 45° Inverted Flare

Male 90° | Elbow | Swivel

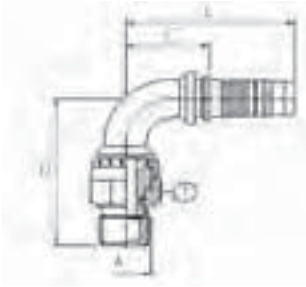

S=Skive  
NS=Non-Skive  
DG=Dual-Grip™

Descriptive #	Product #	SAP #	Hose Size ID		Thread Size (A)		Hex-1 Wrench Size		Drop (D)		Cut-Off (C)		Length (L)		Skive Type	SR3	HR4	SR6, HR6	SR14A
			in.	mm	in.	mm	in.	mm	in.	mm	in.	mm	in.	mm					
UC-SIMX90-0404	36815-0404	20318343	1/4	6.4	7/16-24	1/2	12	2.05	52.1	1.30	33.0	2.28	57.9	NS	UCF6-04		UCF2-04	UCF9-04	
UC-SIMX90-0405	36815-0405	20318344	1/4	6.4	1/2-20	9/16	14	1.96	49.8	1.52	38.6	2.50	63.5	NS	UCF6-04		UCF2-04	UCF9-04	
UC-SIMX90-0604	36815-0604	20318345	3/8	9.5	7/16-24	1/2	12	2.44	62.0	1.34	34.0	2.39	60.7	NS	UCF6-06		UCF2-06	UCF9-06	
UC-SIMX90-0605	36815-0605	20318346	3/8	9.5	1/2-20	9/16	14	2.44	62.0	1.38	35.1	2.43	61.7	NS	UCF6-06		UCF2-06	UCF9-06	
UC-SIMX90-0606	36815-0606	20318347	3/8	9.5	5/8-18	11/16	17	2.44	62.0	1.38	35.1	2.43	61.7	NS	UCF6-06		UCF2-06	UCF9-06	
UC-SIMX90-0607	36815-0607	20318348	3/8	9.5	11/16-18	3/4	19	2.44	62.0	1.38	35.1	2.43	61.7	NS	UCF6-06		UCF2-06	UCF9-06	
UC-SIMX90-0808	36815-0808	20318349	1/2	12.7	3/4-18	3/4	19	2.32	58.9	2.13	54.1	3.38	85.8	NS	UCF6-08		UCF2-08	UCF9-08	

# NPTF

Female

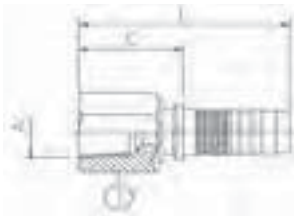

S=Skive  
NS=Non-Skive  
DG=Dual-Grip™

Descriptive #	Product #	SAP #	Hose Size ID		Thread Size (A)		Hex-1 Wrench Size		Cut-Off (C)		Length (L)		Skive Type	SR3	HR4	SR6, HR6	SR14A
			in.	mm	in.	mm	in.	mm	in.	mm	in.	mm					
UC-NPF-0404	36600-0404	20242660	1/4	6.4	1/4-18	3/4	19	1.09	27.6	2.07	52.5	NS	UCF6-04		UCF2-04	UCF9-04	
UC-NPF-0606	36600-0606	20242656	3/8	9.5	3/8-18	7/8	22	1.15	29.2	2.20	55.8	NS	UCF6-06		UCF2-06	UCF9-06	
UC-NPF-0808	36600-0808	20242622	1/2	12.7	1/2-14	1	25	1.40	35.6	2.65	67.2	NS	UCF6-08		UCF2-08	UCF9-08	
UC-NPF-1212	36600-1212	20242548	3/4	19.0	3/4-14	1 1/4	32	1.51	38.4	3.06	77.8	NS	UCF6-12	UCF6-12	UCF2-12	UCF9-12	

# NPTF

Male



S=Skive  
NS=Non-Skive  
DG=Dual-Grip™

Descriptive #	Product #	SAP #	Hose Size ID		Thread Size (A)		Hex-1 Wrench Size		Cut-Off (C)		Length (L)		Skive Type	SR3	HR4	SR6, HR6	SR14A
			in.	mm	in.	mm	in.	mm	in.	mm	in.	mm					
UC-NPM-0302	36615-0302	20242703	3/16	4.8	1/8-27	1/2	12	0.78	19.7	1.65	41.9	NS			UCF2-03	UCF9-03	
UC-NPM-0402	36615-0402	20242766	1/4	6.4	1/8-27	9/16	14	0.84	21.2	1.82	46.1	NS	UCF6-04		UCF2-04	UCF9-04	
UC-NPM-0404	36615-0404	20242780	1/4	6.4	1/4-18	11/16	17	1.06	27.0	2.04	51.9	NS	UCF6-04		UCF2-04	UCF9-04	
UC-NPM-0404S	36615-0404S	20540691	1/4	6.4	1/4-18	11/16	17	1.06	27.0	2.04	51.9	NS	UCF6-04		UCF2-04	UCF9-04	
UC-NPM-0406	36615-0406	20242748	1/4	6.4	3/8-18	3/4	19	1.09	27.7	2.07	52.6	NS	UCF6-04		UCF2-04	UCF9-04	
UC-NPM-0408	36615-0408	20242661	1/4	6.4	1/2-14	7/8	22	1.27	32.2	2.25	57.1	NS	UCF6-04		UCF2-04	UCF9-04	
UC-NPM-0504	36615-0504	20283392	5/16	7.9	1/4-18	11/16	17	1.07	27.1	2.05	52.0	NS	UCF6-05		UCF2-05	UCF9-05	
UC-NPM-0504S	36615-0504S	20540692	5/16	7.9	1/4-18	11/16	17	1.07	27.1	2.05	52.0	NS	UCF6-05		UCF2-05	UCF9-05	
UC-NPM-0506	36615-0506	20283396	5/16	7.9	3/8-18	3/4	19	1.10	27.9	2.08	52.8	NS	UCF6-05		UCF2-05	UCF9-05	
UC-NPM-0508	36615-0508	20592578	5/16	7.9	1/2-14	7/8	22	1.27	32.3	2.25	57.2	NS	UCF6-05		UCF2-05	UCF9-05	
UC-NPM-0604	36615-0604	20242761	3/8	9.5	1/4-18	11/16	17	1.07	27.2	2.12	53.8	NS	UCF6-06		UCF2-06	UCF9-06	
UC-NPM-0606	36615-0606	20242782	3/8	9.5	3/8-18	3/4	19	1.10	27.9	2.15	54.6	NS	UCF6-06		UCF2-06	UCF9-06	
UC-NPM-0606S	36615-0606S	20540693	3/8	9.5	3/8-18	3/4	19	1.10	27.9	2.15	54.6	NS	UCF6-06		UCF2-06	UCF9-06	
UC-NPM-0608	36615-0608	20242767	3/8	9.5	1/2-14	7/8	22	1.27	32.4	2.32	59.0	NS	UCF6-06		UCF2-06	UCF9-06	
UC-NPM-0806	36615-0806	20242722	1/2	12.7	3/8-18	3/4	19	1.12	28.4	2.37	60.1	NS	UCF6-08		UCF2-08	UCF9-08	
UC-NPM-0808	36615-0808	20242775	1/2	12.7	1/2-14	7/8	22	1.30	33.0	2.55	64.7	NS	UCF6-08		UCF2-08	UCF9-08	
UC-NPM-0808S	36615-0808S	20540694	1/2	12.7	1/2-14	7/8	22	1.30	33.0	2.55	64.7	NS	UCF6-08		UCF2-08	UCF9-08	
UC-NPM-0812	36615-0812	20242679	1/2	12.7	3/4-14	1 1/16	27	1.34	34.1	2.59	65.8	NS	UCF6-08		UCF2-08	UCF9-08	
UC-NPM-1012	36615-1012	20274105	5/8	15.9	3/4-14	1 1/16	27	1.35	34.4	2.71	68.9	NS	UCF6-10		UCF2-10	UCF9-10	
UC-NPM-1208	36615-1208	20242689	3/4	19.0	1/2-14	1 1/16	27	1.32	33.5	2.87	73.0	NS	UCF6-12	UCF6-12	UCF2-12	UCF9-12	
UC-NPM-1212	36615-1212	20242771	3/4	19.0	3/4-14	1 1/16	27	1.36	34.6	2.92	74.1	NS	UCF6-12	UCF6-12	UCF2-12	UCF9-12	
UC-NPM-1212S	36615-1212S	20540695	3/4	19.0	3/4-14	1 1/16	27	1.36	34.6	2.92	74.1	NS	UCF6-12	UCF6-12	UCF2-12	UCF9-12	
UC-NPM-1216	36615-1216	20242649	3/4	19.0	1-11 1/2	1 7/16	36	1.72	43.7	3.27	83.1	NS	UCF6-12	UCF6-12	UCF2-12	UCF9-12	
UC-NPM-1612	36615-1612	20242684	1	25.4	3/4-14	1 7/16	36	1.56	39.5	3.33	84.6	NS	UCF6-16	UCF6-16		UCF9-16	
UC-NPM-1616	36615-1616	20242769	1	25.4	1-11 1/2	1 7/16	36	1.73	43.9	3.51	89.0	NS	UCF6-16	UCF6-16		UCF9-16	
UC-NPM-1616S	36615-1616S	20540696	1	25.4	1-11 1/2	1 7/16	36	1.73	43.9	3.51	89.0	NS	UCF6-16	UCF6-16		UCF9-16	
UC-NPM-1620	36615-1620	20242638	1	25.4	1 1/4-11 1/2	1 3/16	46	1.88	47.8	3.66	92.8	NS	UCF6-16	UCF6-16		UCF9-16	
UC-NPM-2020	36615-2020	20242773	1 1/4	31.8	1 1/4-11 1/2	1 3/16	46	1.95	49.5	4.00	101.5	NS		UCF6-20			
UC-NPM-2424	36615-2424	20242685	1 1/2	38.1	1 1/2-11 1/2	2	50	2.01	51.0	4.34	110.1	NS		UCF6-24			
UC-NPM-3232	36615-3232	20242642	2	50.8	2-11 1/2	2 9/16	65	2.14	54.5	4.98	126.4	NS		UCF6-32			

S: Stainless Steel

# NPTF

Male | Swivel



S=Skive  
NS=Non-Skive  
DG=Dual-Grip™

Descriptive #	Product #	SAP #	Hose Size ID		Thread Size (A)		Hex-1 Wrench Size		Cut-Off (C)		Length (L)		Skive Type			SR6, HR6	SR14A
			in.	mm	in.	mm	in.	mm	in.	mm	in.	mm	SR3	HR4			
UC-NPMX-0404	36645-0404	20242757	1/4	6.4	1/4-18	11/16	17	1.49	37.8	2.47	62.7	NS	UCF6-04		UCF2-04	UCF9-04	
UC-NPMX-0406	36645-0406	20242519	1/4	6.4	3/8-18	7/8	22	1.57	39.9	2.55	64.8	NS	UCF6-04		UCF2-04	UCF9-04	
UC-NPMX-0604	36645-0604	20242745	3/8	9.5	1/4-18	11/16	17	1.58	40.1	2.63	66.8	NS	UCF6-06		UCF2-06	UCF9-06	
UC-NPMX-0606	36645-0606	20242777	3/8	9.5	3/8-18	7/8	22	1.49	37.8	2.54	64.4	NS	UCF6-06		UCF2-06	UCF9-06	
UC-NPMX-0608	36645-0608	20242751	3/8	9.5	1/2-14	1	25	1.71	43.5	2.76	70.2	NS	UCF6-06		UCF2-06	UCF9-06	
UC-NPMX-0806	36645-0806	20242503	1/2	12.7	3/8-18	7/8	22	1.51	38.5	2.76	70.1	NS	UCF6-08		UCF2-08	UCF9-08	
UC-NPMX-0808	36645-0808	20242762	1/2	12.7	1/2-14	1	25	1.66	42.3	2.91	73.9	NS	UCF6-08		UCF2-08	UCF9-08	
UC-NPMX-1212	36645-1212	20242730	3/4	19.0	3/4-14	1 1/4	32	1.97	50.1	3.53	89.6	NS	UCF6-12	UCF6-12	UCF2-12	UCF9-12	
UC-NPMX-1616	36645-1616	20242739	1	25.4	1-11 1/2	1 3/8	41	2.30	58.4	4.07	103.5	NS	UCF6-16	UCF6-16		UCF9-16	

# NPTF

Male | 90° Elbow (Block) | Swivel



S=Skive  
NS=Non-Skive  
DG=Dual-Grip™

Descriptive #	Product #	SAP #	Hose Size ID		Thread Size (A)		Hex-1 Wrench Size		Drop (D)		Cut-Off (C)		Length (L)		Skive Type			SR6, HR6	SR14A
			in.	mm	in.	mm	in.	mm	in.	mm	in.	mm	in.	mm	SR3	HR4			
UC-NPMX90B-0404	36650-0404	20318350	1/4	6.4	1/4-18	11/16	17	1.69	42.9	0.71	18.1	1.69	43.0	NS	UCF6-04		UCF2-04	UCF9-04	
UC-NPMX90B-0604	36650-0604	20318351	3/8	9.5	1/4-18	11/16	17	1.63	41.5	0.92	23.3	1.97	50.0	NS	UCF6-06		UCF2-06	UCF9-06	
UC-NPMX90B-0606	36650-0606	20318352	3/8	9.5	3/8-18	7/8	22	1.62	41.2	0.92	23.3	1.97	50.0	NS	UCF6-06		UCF2-06	UCF9-06	
UC-NPMX90B-0808	36650-0808	20318353	1/2	12.7	1/2-14	1	25	2.15	54.6	1.16	29.4	2.41	61.1	NS	UCF6-08		UCF2-08	UCF9-08	
UC-NPMX90B-1212	36650-1212	20318364	3/4	19.0	3/4-14	1 1/4	32	2.58	65.6	1.24	31.5	2.80	71.0	NS	UCF6-12	UCF6-12	UCF2-12	UCF9-12	

# NPSM

Female | Swivel

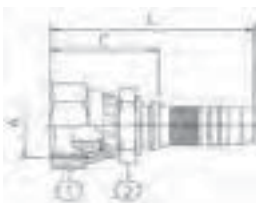

S=Skive  
NS=Non-Skive  
DG=Dual-Grip™

Descriptive #	Product #	SAP #	Hose Size ID		Thread Size (A)		Hex-1 Wrench Size		Hex-2 Wrench Size		Cut-Off (C)		Length (L)		Skive Type			SR6, HR6	SR14A
			in.	mm	in.	mm	in.	mm	in.	mm	in.	mm	in.	mm	SR3	HR4			
UC-NSFX-0404	36655-0404	20242668	1/4	6.4	1/4-18	3/4	19	11/16	17	1.19	30.2	2.17	55.1	NS	UCF6-04		UCF2-04	UCF9-04	
UC-NSFX-0606	36655-0606	20242669	3/8	9.5	3/8-18	7/8	22	3/4	19	1.24	31.4	2.29	58.0	NS	UCF6-06		UCF2-06	UCF9-06	
UC-NSFX-0808	36655-0808	20242654	1/2	12.7	1/2-14	1 1/8	27	7/8	22	1.35	34.3	2.60	66.0	NS	UCF6-08		UCF2-08	UCF9-08	

## Flareless Tube Fittings (SAE J514)

Male

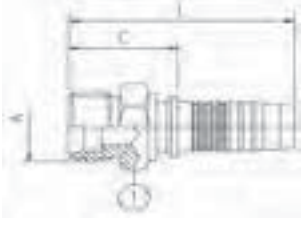

S=Skive  
NS=Non-Skive  
DG=Dual-Grip™

Descriptive #	Product #	SAP #	Hose Size ID		Thread Size (A)		Hex-1 Wrench Size		Cut-Off (C)		Length (L)		Skive Type	SR3	HR4	SR6, HR6	SR14A
			in.	mm	in.	mm	in.	mm	in.	mm	in.	mm					
UC-FTM-0404	36360-0404	20286107	1/4	6.4	7/16-20	1/2	12	0.88	22.2	1.86	47.1	NS	UCF6-04		UCF2-04	UCF9-04	
UC-FTM-0506	36360-0506	20295568	5/16	7.9	9/16-18	5/8	16	0.97	24.7	1.95	49.6	NS	UCF6-05		UCF2-05	UCF9-05	
UC-FTM-0606	36360-0606	20286108	3/8	9.5	9/16-18	5/8	16	0.97	24.7	2.02	51.4	NS	UCF6-06		UCF2-06	UCF9-06	

\*All Fittings come with Nut and Sleeve

## Standpipe

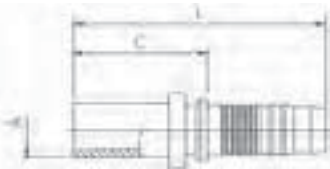

S=Skive  
NS=Non-Skive  
DG=Dual-Grip™

Descriptive #	Product #	SAP #	Hose Size ID		Tube OD (A)	Cut-Off (C)		Length (L)		Skive Type	SR3	HR4	SR6, HR6	SR14A
			in.	mm		in.	mm	in.	mm					
UC-SP-0408	36825-0408	20242506	1/4	6.4	8	1.19	30.3	2.17	55.2	NS	UCF6-04		UCF2-04	UCF9-04
UC-SP-0410	36825-0410	20242461	1/4	6.4	10	1.27	32.3	2.25	57.2	NS	UCF6-04		UCF2-04	UCF9-04
UC-SP-0610	36825-0610	20242555	3/8	9.5	10	1.19	30.2	2.24	56.9	NS	UCF6-06		UCF2-06	UCF9-06
UC-SP-0612	36825-0612	20242576	3/8	9.5	12	1.15	29.2	2.20	55.9	NS	UCF6-06		UCF2-06	UCF9-06
UC-SP-0815	36825-0815	20242372	1/2	12.7	15	1.26	32.0	2.51	63.7	NS	UCF6-08		UCF2-08	UCF9-08
UC-SP-0816	36825-0816	20242482	1/2	12.7	16	1.46	37.1	2.71	68.8	NS	UCF6-08		UCF2-08	UCF9-08
UC-SP-1222	36825-1222	20242373	3/4	19.0	22	1.44	36.6	2.99	76.0	NS	UCF6-12	UCF6-12	UCF2-12	UCF9-12
UC-SP-1628	36825-1628	20242371	1	25.4	28	1.59	40.4	3.37	85.5	NS	UCF6-16	UCF6-16		UCF9-16

## Standpipe

45° Elbow

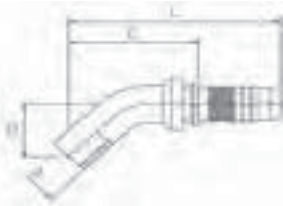

S=Skive  
NS=Non-Skive  
DG=Dual-Grip™

Descriptive #	Product #	SAP #	Hose Size ID		Tube OD (A)	Drop (D)		Cut-Off (C)		Length (L)		Skive Type	SR3	HR4	SR6, HR6	SR14A
			in.	mm		in.	mm	in.	mm	in.	mm					
UC-SP45-0408	36830-0408	20242370	1/4	6.4	8	0.91	23.1	1.69	42.9	2.67	67.8	NS	UCF6-04		UCF2-04	UCF9-04



# O-Ring Face Seal (SAE J1453 ORS/ORFS)

Female | Swivel

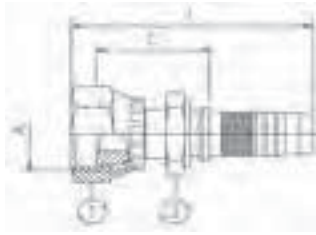

S=Skive  
NS=Non-Skive  
DG=Dual-Grip™

Descriptive #	Product #	SAP #	Hose Size ID		Thread Size (A)		Hex-1 Wrench Size		Hex-2 Wrench Size		Cut-Off (C)		Length (L)		Skive Type	SR3	HR4	SR6, HR6	SR14A
			in.	mm	in.	mm	in.	mm	in.	mm	in.	mm	in.	mm					
UC-OFFX-0404	36700-0404	20242723	1/4	6.4	9/16-18	11/16	17	9/16	14	1.07	27.3	2.05	52.2	NS	UCF6-04		UCF2-04	UCF9-04	
UC-OFFX-0406	36700-0406	20242655	1/4	6.4	11/16-16	7/8	22	11/16	17	1.19	30.1	2.17	55.0	NS	UCF6-04		UCF2-04	UCF9-04	
UC-OFFX-0408	36700-0408	20242441	1/4	6.4	13/16-16	15/16	24	7/8	22	1.39	35.4	2.37	60.3	NS	UCF6-04		UCF2-04	UCF9-04	
UC-OFFX-0506	36700-0506	20242544	5/16	7.9	11/16-16	7/8	22	11/16	17	1.19	30.2	2.17	55.1	NS	UCF6-05		UCF2-05	UCF9-05	
UC-OFFX-0604	36700-0604	20612477	3/8	9.5	9/16-18	11/16	17	11/16	17	1.12	28.4	2.17	55.1	NS	UCF6-06		UCF2-06	UCF9-06	
UC-OFFX-0606	36700-0606	20242763	3/8	9.5	11/16-16	7/8	22	11/16	17	1.19	30.3	2.24	56.9	NS	UCF6-06		UCF2-06	UCF9-06	
UC-OFFX-0608	36700-0608	20242691	3/8	9.5	13/16-16	15/16	24	7/8	22	1.40	35.6	2.45	62.2	NS	UCF6-06		UCF2-06	UCF9-06	
UC-OFFX-0806	36700-0806	20242552	1/2	12.7	11/16-16	7/8	22	3/4	19	1.26	32.0	2.51	63.7	NS	UCF6-08		UCF2-08	UCF9-08	
UC-OFFX-0808	36700-0808	20242733	1/2	12.7	13/16-16	15/16	24	7/8	22	1.42	36.1	2.67	67.8	NS	UCF6-08		UCF2-08	UCF9-08	
UC-OFFX-0810	36700-0810	20242704	1/2	12.7	1-14	1 3/16	30	15/16	24	1.56	39.5	2.80	71.2	NS	UCF6-08		UCF2-08	UCF9-08	
UC-OFFX-0812	36700-0812	20242551	1/2	12.7	1 3/16-12	1 7/16	36	1 3/16	30	1.66	42.1	2.90	73.8	NS	UCF6-08		UCF2-08	UCF9-08	
UC-OFFX-1010	36700-1010	20242442	5/8	15.9	1-14	1 3/16	30	15/16	24	1.56	39.6	2.92	74.1	NS	UCF6-10		UCF2-10	UCF9-10	
UC-OFFX-1012	36700-1012	20242367	5/8	15.9	1 3/16-12	1 7/16	36	1 3/16	30	1.66	42.1	3.10	78.8	NS	UCF6-10		UCF2-10	UCF9-10	
UC-OFFX-1210	36700-1210	20242553	3/4	19.0	1-14	1 3/16	30	1 1/16	27	1.58	40.1	3.13	79.5	NS	UCF6-12	UCF6-12	UCF2-12	UCF9-12	
UC-OFFX-1212	36700-1212	20242741	3/4	19.0	1 3/16-12	1 7/16	36	1 3/16	30	1.67	42.3	3.22	81.8	NS	UCF6-12	UCF6-12	UCF2-12	UCF9-12	
UC-OFFX-1216	36700-1216	20242646	3/4	19.0	1 7/16-12	1 5/8	41	1 7/16	36	1.92	48.6	3.47	88.1	NS	UCF6-12	UCF6-12	UCF2-12	UCF9-12	
UC-OFFX-1612	36700-1612	20242521	1	25.4	1 3/16-12	1 7/16	36	1 1/4	32	1.79	45.3	3.56	90.4	NS	UCF6-16	UCF6-16		UCF9-16	
UC-OFFX-1616	36700-1616	20242734	1	25.4	1 7/16-12	1 5/8	41	1 7/16	36	1.95	49.4	3.72	94.5	NS	UCF6-16	UCF6-16		UCF9-16	
UC-OFFX-1620	36700-1620	20242505	1	25.4	1 11/16-12	2	50	1 5/8	41	1.98	50.3	3.76	95.4	NS	UCF6-16	UCF6-16		UCF9-16	
UC-OFFX-2020	36700-2020	20242692	1 1/4	31.8	1 11/16-12	2	50	1 5/8	41	2.08	52.9	4.13	104.9	NS		UCF6-20			
UC-OFFX-2424	36700-2424	20242495	1 1/2	38.1	2-12	2 3/8	60	2	50	2.23	56.7	4.56	115.8	NS		UCF6-24			

# O-Ring Face Seal (SAE J1453 ORS/ORFS)

Female | 45° Elbow | Swivel

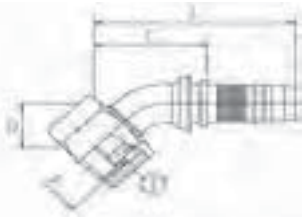

S=Skive  
NS=Non-Skive  
DG=Dual-Grip™

Descriptive #	Product #	SAP #	Hose Size ID		Thread Size (A)		Hex-1 Wrench Size		Hex-2 Wrench Size		Cut-Off (C)		Length (L)		Skive Type	SR3	HR4	SR6, HR6	SR14A
			in.	mm	in.	mm	in.	mm	in.	mm	in.	mm	in.	mm					
UC-OFFX45-0404	36710-0404	20242631	1/4	6.4	9/16-18	11/16	17	0.43	10.9	1.61	41.0	2.60	66.0	NS	UCF6-04		UCF2-04	UCF9-04	
UC-OFFX45-0406	36710-0406	20242549	1/4	6.4	11/16-16	7/8	22	0.43	10.9	1.81	46.0	2.80	71.0	NS	UCF6-04		UCF2-04	UCF9-04	
UC-OFFX45-0506	36710-0506	20242456	5/16	7.9	11/16-16	7/8	22	0.47	11.9	1.81	46.0	2.99	76.0	NS	UCF6-05		UCF2-05	UCF9-05	
UC-OFFX45-0606	36710-0606	20242683	3/8	9.5	11/16-16	7/8	22	0.47	11.9	1.85	47.0	2.91	74.0	NS	UCF6-06		UCF2-06	UCF9-06	
UC-OFFX45-0608	36710-0608	20242593	3/8	9.5	13/16-16	15/16	24	0.59	15.0	2.01	51.0	3.07	78.0	NS	UCF6-06		UCF2-06	UCF9-06	
UC-OFFX45-0808 <sup>c</sup>	36710-0808	20242637	1/2	12.7	13/16-16	15/16	24	0.63	16.0	1.85	47.0	3.11	79.0	NS	UCF6-08		UCF2-08	UCF9-08	
UC-OFFX45-0810	36710-0810	20242532	1/2	12.7	1-14	1 3/16	30	0.65	16.5	1.97	50.0	3.23	82.0	NS	UCF6-08		UCF2-08	UCF9-08	
UC-OFFX45-1212	36710-1212	20242681	3/4	19.0	1 3/16-12	1 7/16	36	0.83	21.0	2.48	63.0	4.06	103.0	NS	UCF6-12	UCF6-12	UCF2-12	UCF9-12	
UC-OFFX45-1216	36710-1216	20242359	3/4	19.0	1 7/16-12	1 5/8	41	0.94	23.9	2.80	71.1	4.33	110.0	NS	UCF6-12	UCF6-12	UCF2-12	UCF9-12	
UC-OFFX45-1616	36710-1616	20242643	1	25.4	1 7/16-12	1 5/8	41	1.02	26.0	3.23	81.9	5.00	127.0	NS	UCF6-16	UCF6-16		UCF9-16	
UC-OFFX45-1620	36710-1620	20242355	1	25.4	1 11/16-12	2	50	1.02	25.9	3.35	85.1	5.41	137.5	NS	UCF6-16	UCF6-16		UCF9-16	
UC-OFFX45-2020	36710-2020	20242609	1 1/4	31.8	1 11/16-12	2	50	1.02	25.9	3.82	97.0	6.16	156.5	NS		UCF6-20			
UC-OFFX45-2024	36710-2024	20242477	1 1/4	31.8	2-12	2 3/8	60	1.10	27.9	3.98	101.1	6.34	161.0	NS		UCF6-20			
UC-OFFX45-2424	36710-2424	20242357	1 1/2	38.1	2-12	2 3/8	60	1.10	27.9	4.13	104.9	6.77	172.0	NS		UCF6-24			

C: Crimp Nut (see "Fitting Identification" in Appendix for details)

# O-Ring Face Seal (SAE J1453 ORS/ORFS)

Female | 90° Elbow | Swivel

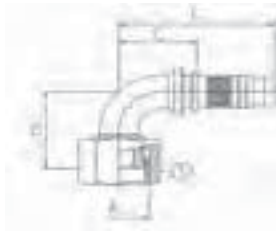

Elbow Type:  
LT=Long Tube  
ST=Short Tube

S=Skive  
NS=Non-Skive  
DG=Dual-Grip™

Descriptive #	Product #	SAP #	Hose Size ID		Thread Size (A)		Hex-1 Wrench Size		Elbow Type		Drop (D)		Cut-Off (C)		Length (L)		Skive Type		SR6, HR6	SR14A	
			in.	mm	in.	mm	in.	mm	in.	mm	in.	mm	in.	mm	in.	mm	SR3	HR4			
UC-OFFX90-0404	36715-0404	20242602	1/4	6.4	9/16-18	11/16	17				1.26	32.0	1.18	30.0	2.16	54.9	NS	UCF6-04	UCF2-04	UCF9-04	
UC-OFFX90L-0404	36720-0404	20242533	1/4	6.4	9/16-18	11/16	17	LT			1.81	46.0	1.30	33.0	2.28	57.9	NS	UCF6-04	UCF2-04	UCF9-04	
UC-OFFX90S-0404	36725-0404	20242682	1/4	6.4	9/16-18	11/16	17	ST			0.83	21.0	1.10	28.0	2.08	52.9	NS	UCF6-04	UCF2-04	UCF9-04	
UC-OFFX90-0406	36715-0406	20242479	1/4	6.4	11/16-16	7/8	22				1.50	38.0	1.46	37.0	2.44	61.9	NS	UCF6-04	UCF2-04	UCF9-04	
UC-OFFX90L-0406	36720-0406	20242492	1/4	6.4	11/16-16	7/8	22	LT			2.13	54.0	1.38	35.0	2.36	59.9	NS	UCF6-04	UCF2-04	UCF9-04	
UC-OFFX90S-0406	36725-0406	20242598	1/4	6.4	11/16-16	7/8	22	ST			0.91	23.0	1.26	32.0	2.24	56.9	NS	UCF6-04	UCF2-04	UCF9-04	
UC-OFFX90S-0506	36725-0506	20242494	5/16	7.9	11/16-16	7/8	22	ST			0.98	24.9	1.61	40.9	2.59	65.8	NS	UCF6-05	UCF2-05	UCF9-05	
UC-OFFX90-0606	36715-0606	20242633	3/8	9.5	11/16-16	7/8	22				1.50	38.0	1.65	42.0	2.70	68.6	NS	UCF6-06	UCF2-06	UCF9-06	
UC-OFFX90L-0606	36720-0606	20242615	3/8	9.5	11/16-16	7/8	22	LT			2.13	54.0	1.65	42.0	2.70	68.6	NS	UCF6-06	UCF2-06	UCF9-06	
UC-OFFX90S-0606	36725-0606	20242717	3/8	9.5	11/16-16	7/8	22	ST			0.98	25.0	1.65	42.0	2.70	68.6	NS	UCF6-06	UCF2-06	UCF9-06	
UC-OFFX90-0608	36715-0608	20242480	3/8	9.5	13/16-16	15/16	24				1.61	41.0	1.73	44.0	2.78	70.6	NS	UCF6-06	UCF2-06	UCF9-06	
UC-OFFX90L-0608	36720-0608	20242493	3/8	9.5	13/16-16	15/16	24	LT			2.52	64.0	1.85	47.0	2.90	73.6	NS	UCF6-06	UCF2-06	UCF9-06	
UC-OFFX90S-0608	36725-0608	20242620	3/8	9.5	13/16-16	15/16	24	ST			1.14	29.0	1.65	42.0	2.70	68.6	NS	UCF6-06	UCF2-06	UCF9-06	
UC-OFFX90-0808 <sup>C</sup>	36715-0808	20242571	1/2	12.7	13/16-16	15/16	24				1.65	42.0	1.38	35.0	2.63	66.7	NS	UCF6-08	UCF2-08	UCF9-08	
UC-OFFX90L-0808 <sup>C</sup>	36720-0808	20242566	1/2	12.7	13/16-16	15/16	24	LT			2.52	64.0	1.50	38.0	2.74	69.7	NS	UCF6-08	UCF2-08	UCF9-08	
UC-OFFX90S-0808 <sup>C</sup>	36725-0808	20242663	1/2	12.7	13/16-16	15/16	24	ST			1.14	29.0	1.58	40.0	2.82	71.7	NS	UCF6-08	UCF2-08	UCF9-08	
UC-OFFX90-0810	36715-0810	20242363	1/2	12.7	1-14	1 3/8	30				1.85	47.0	1.89	48.0	3.14	79.7	NS	UCF6-08	UCF2-08	UCF9-08	
UC-OFFX90L-0810	36720-0810	20242438	1/2	12.7	1-14	1 3/8	30	LT			2.76	70.1	1.81	46.0	3.06	77.6	NS	UCF6-08	UCF2-08	UCF9-08	
UC-OFFX90S-0810	36725-0810	20242550	1/2	12.7	1-14	1 3/8	30	ST			1.28	32.5	1.81	46.0	3.06	77.6	NS	UCF6-08	UCF2-08	UCF9-08	
UC-OFFX90S-0812	36725-0812	20318321	1/2	12.7	1 3/8-12	1 7/8	36	ST			2.01	51.1	2.19	55.6	3.44	87.3	NS	UCF6-08	UCF2-08	UCF9-08	
UC-OFFX90-1010	36715-1010	20242403	5/8	15.9	1-14	1 3/8	30				1.73	44.0	2.17	55.0	3.52	89.5	NS	UCF6-10	UCF2-10	UCF9-10	
UC-OFFX90S-1010	36725-1010	20242365	5/8	15.9	1-14	1 3/8	30	ST			1.28	32.5	2.05	52.0	3.40	86.5	NS	UCF6-10	UCF2-10	UCF9-10	
UC-OFFX90S-1012	36725-1012	20242364	5/8	15.9	1 3/8-12	1 7/8	36	ST			1.93	49.0	2.17	55.1	3.53	89.6	NS	UCF6-10	UCF2-10	UCF9-10	
UC-OFFX90S-1210	36725-1210	20242457	3/4	19.0	1-14	1 3/8	30	ST			1.54	39.1	1.75	44.5	3.30	83.9	NS	UCF6-12	UCF6-12	UCF2-12	UCF9-12
UC-OFFX90-1212	36715-1212	20242439	3/4	19.0	1 3/8-12	1 7/8	36				2.28	58.0	2.44	62.0	3.99	101.4	NS	UCF6-12	UCF6-12	UCF2-12	UCF9-12
UC-OFFX90L-1212	36720-1212	20242514	3/4	19.0	1 3/8-12	1 7/8	36	LT			3.78	96.0	2.44	62.0	3.99	101.4	NS	UCF6-12	UCF6-12	UCF2-12	UCF9-12
UC-OFFX90S-1212	36725-1212	20242680	3/4	19.0	1 3/8-12	1 7/8	36	ST			2.01	51.0	2.40	61.0	3.96	100.5	NS	UCF6-12	UCF6-12	UCF2-12	UCF9-12
UC-OFFX90S-1216	36725-1216	20242481	3/4	19.0	1 7/8-12	1 5/8	41	ST			2.80	71.1	2.60	66.0	4.15	105.5	NS	UCF6-12	UCF6-12	UCF2-12	UCF9-12
UC-OFFX90-1616	36715-1616	20242478	1	25.4	1 7/8-12	1 5/8	41				2.60	66.0	3.27	83.0	5.04	128.1	NS	UCF6-16	UCF6-16		UCF9-16
UC-OFFX90L-1616	36720-1616	20242504	1	25.4	1 7/8-12	1 5/8	41	LT			4.49	114.0	3.27	83.0	5.04	128.1	NS	UCF6-16	UCF6-16		UCF9-16
UC-OFFX90S-1616	36725-1616	20242690	1	25.4	1 7/8-12	1 5/8	41	ST			2.28	58.0	3.27	83.0	5.04	128.1	NS	UCF6-16	UCF6-16		UCF9-16
UC-OFFX90-1620	36715-1620	20242360	1	25.4	1 11/8-12	2	50				3.07	78.0	3.27	83.0	5.04	128.1	NS	UCF6-16	UCF6-16		UCF9-16
UC-OFFX90S-1620	36725-1620	20242440	1	25.4	1 11/8-12	2	50	ST			2.52	64.0	3.27	83.0	5.04	128.1	NS	UCF6-16	UCF6-16		UCF9-16
UC-OFFX90S-2020	36725-2020	20242671	1 1/4	31.8	1 11/8-12	2	50	ST			2.68	68.1	3.74	95.0	5.79	147.0	NS		UCF6-20		
UC-OFFX90L-2024	36720-2024	20242402	1 1/4	31.8	2-12	2 3/8	60	LT			5.55	141.0	4.02	102.1	6.07	154.1	NS		UCF6-20		
UC-OFFX90S-2024	36725-2024	20242405	1 1/4	31.8	2-12	2 3/8	60	ST			2.72	69.1	4.02	102.1	6.07	154.1	NS		UCF6-20		
UC-OFFX90S-2424	36725-2424	20242404	1 1/2	38.1	2-12	2 3/8	60	ST			3.07	78.0	4.02	102.1	6.35	161.2	NS		UCF6-24		

C: Crimp Nut (see "Fitting Identification" in Appendix for details)

# O-Ring Face Seal (SAE J1453) ORS/ORFS

Male



S=Skive  
NS=Non-Skive  
DG=Dual-Grip™

Descriptive #	Product #	SAP #	Hose Size ID		Thread Size (A)		Hex-1 Wrench Size		Cut-Off (C)		Length (L)		Skive Type	SR3	HR4	SR6, HR6	SR14A
			in.	mm	in.	mm	in.	mm	in.	mm	in.	mm					
UC-OFM-0404	36730-0404	20242567	1/4	6.4	9/16-18	11/16	17	1.00	25.4	1.98	50.3	NS	UCF6-04		UCF2-04	UCF9-04	
UC-OFM-0406	36730-0406	20777952	1/4	6.4	11/16-16	3/4	19	0.96	24.3	1.94	49.1	NS	UCF6-04		UCF2-04	UCF9-04	
UC-OFM-0606	36730-0606	20242596	3/8	9.5	11/16-16	3/4	19	1.05	26.7	2.10	53.4	NS	UCF6-06		UCF2-06	UCF9-06	
UC-OFM-0608	36730-0608	20242575	3/8	9.5	13/16-16	7/8	22	1.05	26.6	2.10	53.2	NS	UCF6-06		UCF2-06	UCF9-06	
UC-OFM-0808	36730-0808	20242545	1/2	12.7	13/16-16	7/8	22	1.19	30.3	2.44	62.0	NS	UCF6-08		UCF2-08	UCF9-08	
UC-OFM-0810	36730-0810	20242369	1/2	12.7	1-14	1 1/16	27	1.21	30.7	2.46	62.4	NS	UCF6-08		UCF2-08	UCF9-08	
UC-OFM-0812	36730-0812	20242368	1/2	12.7	1 3/16-12	1 1/4	32	1.34	34.0	2.59	65.7	NS	UCF6-08		UCF2-08	UCF9-08	
UC-OFM-1212	36730-1212	20242535	3/4	19.0	1 3/16-12	1 1/4	32	1.36	34.6	2.92	74.1	NS	UCF6-12	UCF6-12	UCF2-12	UCF9-12	
UC-OFM-1216	36730-1216	20242443	3/4	19.0	1 7/16-12	1 5/8	41	1.55	39.3	3.10	78.8	NS	UCF6-12	UCF6-12	UCF2-12	UCF9-12	
UC-OFM-1616	36730-1616	20242459	1	25.4	1 7/16-12	1 1/2	38	1.47	37.4	3.25	82.5	NS	UCF6-16	UCF6-16		UCF9-16	
UC-OFM-2020	36730-2020	20242460	1 1/4	31.8	1 11/16-12	1 3/16	46	1.64	41.7	3.69	93.7	NS		UCF6-20			

# O-Ring Boss Straight Thread (SAE J514)

Male

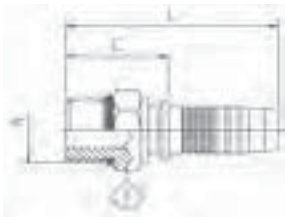

S=Skive  
NS=Non-Skive  
DG=Dual-Grip™

Descriptive #	Product #	SAP #	Hose Size ID		Thread Size (A)		Hex-1 Wrench Size		Cut-Off (C)		Length (L)		Skive Type	SR3	HR4	SR6, HR6	SR14A
			in.	mm	in.	mm	in.	mm	in.	mm	in.	mm					
UC-OBM-0404	36670-0404	20242597	1/4	6.4	7/16-20	9/16	14	0.88	22.3	1.86	47.2	NS	UCF6-04		UCF2-04	UCF9-04	
UC-OBM-0405	36670-0405	20242531	1/4	6.4	1/2-20	5/8	16	0.88	22.3	1.86	47.2	NS	UCF6-04		UCF2-04	UCF9-04	
UC-OBM-0406	36670-0406	20242591	1/4	6.4	9/16-18	11/16	17	0.88	22.3	1.86	47.2	NS	UCF6-04		UCF2-04	UCF9-04	
UC-OBM-0606	36670-0606	20242677	3/8	9.5	9/16-18	3/4	19	0.94	23.7	1.98	50.4	NS	UCF6-06		UCF2-06	UCF9-06	
UC-OBM-0608	36670-0608	20242672	3/8	9.5	3/4-16	7/8	22	0.73	18.6	2.04	51.7	NS	UCF6-06		UCF2-06	UCF9-06	
UC-OBM-0610	36670-0610	20242614	3/8	9.5	7/8-14	1 1/16	27	1.08	27.4	2.13	54.1	NS	UCF6-06		UCF2-06	UCF9-06	
UC-OBM-0808	36670-0808	20242665	1/2	12.7	3/4-16	7/8	22	1.01	25.6	2.26	57.3	NS	UCF6-08		UCF2-08	UCF9-08	
UC-OBM-0810	36670-0810	20242595	1/2	12.7	7/8-14	1 1/16	27	1.10	27.9	2.35	59.6	NS	UCF6-08		UCF2-08	UCF9-08	
UC-OBM-0812	36670-0812	20242476	1/2	12.7	1 1/16-12	1 1/4	32	1.26	32.1	2.51	63.8	NS	UCF6-08		UCF2-08	UCF9-08	
UC-OBM-1210	36670-1210	20242520	3/4	19.0	7/8-14	1 1/16	27	1.13	28.6	2.68	68.0	NS	UCF6-12	UCF6-12	UCF2-12	UCF9-12	
UC-OBM-1212	36670-1212	20242592	3/4	19.0	1 1/16-12	1 1/4	32	1.29	32.7	2.84	72.2	NS	UCF6-12	UCF6-12	UCF2-12	UCF9-12	
UC-OBM-1216	36670-1216	20242455	3/4	19.0	1 5/16-12	1 1/2	38	1.37	34.8	2.92	74.2	NS	UCF6-12	UCF6-12	UCF2-12	UCF9-12	
UC-OBM-1616	36670-1616	20242589	1	25.4	1 3/16-12	1 1/2	38	1.38	35.0	3.15	80.1	NS	UCF6-16	UCF6-16		UCF9-16	

## O-Ring Boss Straight Thread (SAE J514)

Male | Swivel



S=Skive  
NS=Non-Skive  
DG=Dual-Grip™

Descriptive #	Product #	SAP #	Hose Size ID		Thread Size (A)		Hex-1 Wrench Size		Cut-Off (C)		Length (L)		Skive Type	SR3	HR4	SR6, HR6	SR14A
			in.	mm	in.	mm	in.	mm	in.	mm	in.	mm					
UC-OBMX-0608	36680-0608	20318237	3/8	9.5	3/4-16	1	25	1.73	44.0	2.78	70.6	NS	UCF6-06		UCF2-06	UCF9-06	
UC-OBMX-0808	36680-0808	20318238	1/2	12.7	3/4-16	1	25	1.68	42.7	2.93	74.4	NS	UCF6-08		UCF2-08	UCF9-08	
UC-OBMX-0810	36680-0810	20318239	1/2	12.7	7/8-14	1	25	1.69	42.9	2.94	74.6	NS	UCF6-08		UCF2-08	UCF9-08	

## O-Ring Boss Straight Thread (SAE J514)

Male | 90° Elbow (Block) | Swivel



S=Skive  
NS=Non-Skive  
DG=Dual-Grip™

Descriptive #	Product #	SAP #	Hose Size ID		Thread Size (A)		Hex-1 Wrench Size		Drop (D)		Cut-Off (C)		Length (L)		Skive Type	SR3	HR4	SR6, HR6	SR14A
			in.	mm	in.	mm	in.	mm	in.	mm	in.	mm	in.	mm					
UC-OBMX90B-0405	36685-0405	20318354	1/4	6.4	1/2-20	11/16	17	1.48	37.6	0.71	18.1	1.69	43.0	NS	UCF6-04		UCF2-04	UCF9-04	
UC-OBMX90B-0606	36685-0606	20318355	3/8	9.5	9/16-18	7/8	22	1.74	44.3	0.92	23.3	1.97	50.0	NS	UCF6-06		UCF2-06	UCF9-06	
UC-OBMX90B-0608	36685-0608	20318356	3/8	9.5	3/4-16	1	25	2.17	55.0	1.13	28.8	2.18	55.4	NS	UCF6-06		UCF2-06	UCF9-06	
UC-OBMX90B-0808	36685-0808	20318357	1/2	12.7	3/4-16	1	25	2.17	55.0	1.16	29.4	2.41	61.1	NS	UCF6-08		UCF2-08	UCF9-08	
UC-OBMX90B-0810	36685-0810	20318358	1/2	12.7	7/8-14	1	25	2.17	55.2	1.16	29.4	2.41	61.1	NS	UCF6-08		UCF2-08	UCF9-08	
UC-OBMX90B-1212	36685-1212	20318365	1	25.4	1 1/16-12	1 1/4	32	2.58	65.5	1.24	31.5	2.80	71.0	NS	UCF6-12	UCF6-12	UCF2-12	UCF9-12	

## Code 61 Flange (SAE J518)

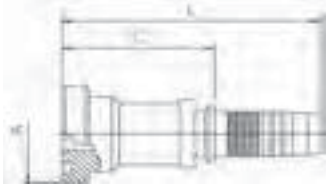

S=Skive  
NS=Non-Skive  
DG=Dual-Grip™

Descriptive #	Product #	SAP #	Hose Size ID		Flange Size	Flange Diameter (A)		Cut-Off (C)		Length (L)		Skive Type	SR3	HR4	SR6, HR6	SR14A
			in.	mm		in.	mm	in.	mm	in.	mm					
UC-FL-0808	36320-0808	20242569	1/2	12.7	1/2	1.19	30.2	1.61	40.9	2.86	72.6	NS	UCF6-08		UCF2-08	UCF9-08
UC-FL-0812	36320-0812	20242300	1/2	12.7	3/4	1.50	38.1	1.65	41.9	2.90	73.6	NS	UCF6-08		UCF2-08	UCF9-08
UC-FL-1212	36320-1212	20242707	3/4	19.0	3/4	1.50	38.1	1.67	42.4	3.22	81.9	NS	UCF6-12	UCF6-12	UCF2-12	UCF9-12
UC-FL-1216	36320-1216	20242650	3/4	19.0	1	1.75	44.5	1.99	50.5	3.54	90.0	NS	UCF6-12	UCF6-12	UCF2-12	UCF9-12
UC-FL-1616	36320-1616	20242744	1	25.4	1	1.75	44.5	2.02	51.3	3.80	96.4	NS	UCF6-16	UCF6-16		UCF9-16
UC-FL-1620	36320-1620	20242697	1	25.4	1¼	2.00	50.8	2.12	53.8	3.90	98.9	NS	UCF6-16	UCF6-16		UCF9-16
UC-FL-2020	36320-2020	20242750	1¼	31.8	1¼	2.00	50.8	2.19	55.6	4.24	107.6	NS		UCF6-20		
UC-FL-2024	36320-2024	20242695	1¼	31.8	1½	2.37	60.3	2.30	58.4	4.35	110.4	NS		UCF6-20		
UC-FL-2424	36320-2424	20242726	1½	38.1	1½	2.37	60.3	2.31	58.7	4.64	117.8	NS		UCF6-24		
UC-FL-2432	36320-2432	20242605	1½	38.1	2	2.81	71.4	2.76	70.1	5.09	129.2	NS		UCF6-24		
UC-FL-3232	36320-3232	20242693	2	50.8	2	2.81	71.4	2.76	70.1	5.59	142.1	NS		UCF6-32		
UC-FL-4040	36320-4040	20242599	2½	63.5	2½	3.31	84.1	2.24	56.9	5.49	139.4	NS		UCF6-40		

## Code 61 Flange (SAE J518)

22.5° Elbow

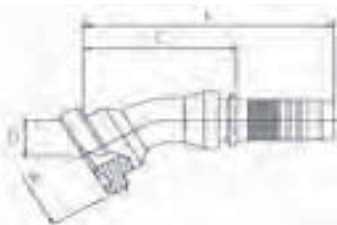

S=Skive  
NS=Non-Skive  
DG=Dual-Grip™

Descriptive #	Product #	SAP #	Hose Size ID		Flange Size	Flange Diameter (A)		Drop (D)		Cut-Off (C)		Length (L)		Skive Type	SR3	HR4	SR6, HR6	SR14A
			in.	mm		in.	mm	in.	mm	in.	mm	in.	mm					
UC-FL22-1616	36330-1616	20242623	1	25.4	1	1.75	44.5	0.47	11.9	3.66	93.0	5.44	138.0	NS	UCF6-16	UCF6-16	UCF9-16	
UC-FL22-2020	36330-2020	20242568	1¼	31.8	1¼	2.00	50.8	0.63	16.0	4.49	114.0	6.54	166.0	NS		UCF6-20		
UC-FL22-2424	36330-2424	20242465	1½	38.1	1½	2.37	60.3	0.65	16.5	5.16	131.1	7.49	190.2	NS		UCF6-24		

## Code 61 Flange (SAE J518)

30° Elbow

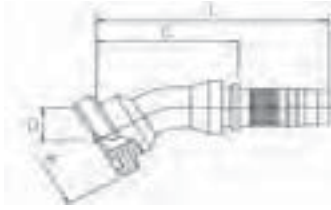

S=Skive  
NS=Non-Skive  
DG=Dual-Grip™

Descriptive #	Product #	SAP #	Hose Size ID		Flange Size		Flange Diameter (A)		Drop (D)		Cut-Off (C)		Length (L)		Skive Type		SR3	HR4	SR6, HR6	SR14A
			in.	mm	in.	mm	in.	mm	in.	mm	in.	mm	in.	mm	NS	S				
UC-FL30-1212	36335-1212	20242577	3/4	19.0	3/4	1.50	38.1	0.75	19.1	3.19	81.0	4.74	120.5	NS	UCF6-12	UCF6-12	UCF2-12	UCF9-12		
UC-FL30-1216	36335-1216	20242379	3/4	19.0	1	1.75	44.5	0.75	19.1	3.31	84.1	4.86	123.5	NS	UCF6-12	UCF6-12	UCF2-12	UCF9-12		
UC-FL30-1616	36335-1616	20242497	1	25.4	1	1.75	44.5	0.83	21.1	3.54	89.9	5.32	135.0	NS	UCF6-16	UCF6-16		UCF9-16		
UC-FL30-1620	36335-1620	20242498	1	25.4	1¼	2.00	50.8	0.87	22.1	3.54	89.9	5.32	135.0	NS	UCF6-16	UCF6-16		UCF9-16		
UC-FL30-2020	36335-2020	20242616	1¼	31.8	1¼	2.00	50.8	0.98	24.9	4.02	102.1	6.07	154.1	NS		UCF6-20				
UC-FL30-2024	36335-2024	20242378	1¼	31.8	1½	2.37	60.3	1.06	26.9	4.41	112.0	6.46	164.0	NS		UCF6-20				
UC-FL30-2424	36335-2424	20242582	1½	38.1	1½	2.37	60.3	0.91	23.1	5.35	135.9	7.68	195.0	NS		UCF6-24				

## Code 61 Flange (SAE J518)

45° Elbow

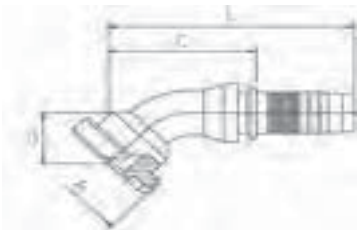

S=Skive  
NS=Non-Skive  
DG=Dual-Grip™

Descriptive #	Product #	SAP #	Hose Size ID		Flange Size		Flange Diameter (A)		Drop (D)		Cut-Off (C)		Length (L)		Skive Type		SR3	HR4	SR6, HR6	SR14A
			in.	mm	in.	mm	in.	mm	in.	mm	in.	mm	in.	mm	NS	S				
UC-FL45-0808	36340-0808	20242508	1/2	12.7	1/2	1.19	30.2	0.87	22.1	2.09	53.1	3.34	84.8	NS	UCF6-08		UCF2-08	UCF9-08		
UC-FL45-0812	36340-0812	20242293	1/2	12.7	3/4	1.50	38.1	1.02	25.9	2.36	59.9	3.61	91.6	NS	UCF6-08		UCF2-08	UCF9-08		
UC-FL45-1212	36340-1212	20242678	3/4	19.0	3/4	1.50	38.1	1.26	32.0	2.91	73.9	4.46	113.4	NS	UCF6-12	UCF6-12	UCF2-12	UCF9-12		
UC-FL45-1216	36340-1216	20242617	3/4	19.0	1	1.75	44.5	1.14	29.0	3.07	78.0	4.62	117.4	NS	UCF6-12	UCF6-12	UCF2-12	UCF9-12		
UC-FL45-1616	36340-1616	20242700	1	25.4	1	1.75	44.5	1.32	33.5	3.27	83.1	5.05	128.1	NS	UCF6-16	UCF6-16		UCF9-16		
UC-FL45-1620	36340-1620	20242653	1	25.4	1¼	2.00	50.8	1.42	36.1	3.23	82.0	5.01	127.1	NS	UCF6-16	UCF6-16		UCF9-16		
UC-FL45-2020	36340-2020	20242705	1¼	31.8	1¼	2.00	50.8	1.48	37.6	3.74	95.0	5.79	147.0	NS		UCF6-20				
UC-FL45-2024	36340-2024	20242648	1¼	31.8	1½	2.37	60.3	1.57	39.9	4.09	103.9	6.14	155.9	NS		UCF6-20				
UC-FL45-2424	36340-2424	20242686	1½	38.1	1½	2.37	60.3	1.89	48.0	4.61	117.1	6.94	176.2	NS		UCF6-24				
UC-FL45-3232	36340-3232	20242640	2	50.8	2	2.81	71.4	1.87	47.5	5.55	141.0	8.38	213.0	NS		UCF6-32				
UC-FL45-4040	36340-4040	20242509	2½	63.5	2½	3.31	84.1	2.09	53.0	5.47	139.0	8.74	222.0	NS		UCF6-40				

DG: Part listed is Dual-Grip™ style (image is Uni-Crimp™ style)

# Code 61 Flange (SAE J518)

60° Elbow

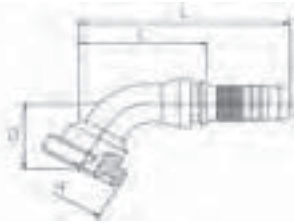

S=Skive  
NS=Non-Skive  
DG=Dual-Grip™

Descriptive #	Product #	SAP #	Hose Size ID		Flange Size	Flange Diameter (A)		Drop (D)		Cut-Off (C)		Length (L)		Skive Type	SR3	HR4	SR6, HR6	SR14A
			in.	mm		in.	mm	in.	mm	in.	mm	in.	mm					
UC-FL60-1212	36345-1212	20242516	3/4	19.0	3/4	1.50	38.1	1.49	37.8	3.39	86.1	4.94	125.6	NS	UCF6-12	UCF6-12	UCF2-12	UCF9-12
UC-FL60-1216	36345-1216	20242499	3/4	19.0	1	1.75	44.5	1.73	43.9	4.02	102.1	5.66	143.8	NS	UCF6-12	UCF6-12	UCF2-12	UCF9-12
UC-FL60-1616	36345-1616	20242510	1	25.4	1	1.75	44.5	1.85	47.0	3.98	101.1	5.76	146.2	NS	UCF6-16	UCF6-16		UCF9-16
UC-FL60-1620	36345-1620	20242560	1	25.4	1 1/4	2.00	50.8	1.71	43.4	4.20	106.7	5.98	151.8	NS	UCF6-16	UCF6-16		UCF9-16
UC-FL60-2020	36345-2020	20242523	1 1/4	31.8	1 1/4	2.00	50.8	2.22	56.4	5.10	129.5	7.15	181.5	NS		UCF6-20		
UC-FL60-2424	36345-2424	20242380	1 1/2	38.1	1 1/2	2.37	60.3	2.28	57.9	5.31	134.9	7.36	186.8	NS		UCF6-24		

# Code 61 Flange (SAE J518)

90° Elbow

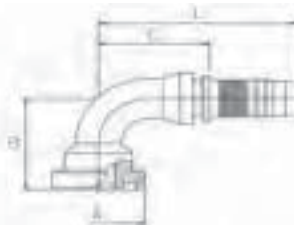

S=Skive  
NS=Non-Skive  
DG=Dual-Grip™

Descriptive #	Product #	SAP #	Hose Size ID		Flange Size	Flange Diameter (A)		Drop (D)		Cut-Off (C)		Length (L)		Skive Type	SR3	HR4	SR6, HR6	SR14A
			in.	mm		in.	mm	in.	mm	in.	mm	in.	mm					
UC-FL90-0808	36350-0808	20242537	1/2	12.7	1/2	1.19	30.2	1.65	41.9	1.81	46.0	3.06	77.6	NS	UCF6-08		UCF2-08	UCF9-08
UC-FL90-0812	36350-0812	20242381	1/2	12.7	3/4	1.50	38.1	2.01	51.1	1.77	45.0	3.02	76.6	NS	UCF6-08		UCF2-08	UCF9-08
UC-FL90-1212	36350-1212	20242696	3/4	19.0	3/4	1.50	38.1	2.36	59.9	2.28	57.9	3.83	97.4	NS	UCF6-12	UCF6-12	UCF2-12	UCF9-12
UC-FL90-1216	36350-1216	20242667	3/4	19.0	1	1.75	44.5	2.54	64.5	2.60	66.0	4.15	105.5	NS	UCF6-12	UCF6-12	UCF2-12	UCF9-12
UC-FL90-1616	36350-1616	20242740	1	25.4	1	1.75	44.5	2.64	67.1	2.80	71.1	4.58	116.2	NS	UCF6-16	UCF6-16		UCF9-16
UC-FL90-1620	36350-1620	20242701	1	25.4	1 1/4	2.00	50.8	2.80	71.1	2.91	73.9	4.69	119.0	NS	UCF6-16	UCF6-16		UCF9-16
UC-FL90-2016	36350-2016	20242583	1 1/4	31.8	1	1.75	44.5	2.56	65.0	3.70	94.0	5.75	145.9	NS		UCF6-20		
UC-FL90-2020	36350-2020	20242735	1 1/4	31.8	1 1/4	2.00	50.8	3.31	84.1	3.46	87.9	5.51	139.9	NS		UCF6-20		
UC-FL90-2024	36350-2024	20242713	1 1/4	31.8	1 1/2	2.37	60.3	3.44	87.4	3.58	90.9	5.63	142.9	NS		UCF6-20		
UC-FL90-2424	36350-2424	20242714	1 1/2	38.1	1 1/2	2.37	60.3	3.58	90.9	4.13	104.9	6.46	164.0	NS		UCF6-24		
UC-FL90-2432	36350-2432	20242724	1 1/2	38.1	2	2.81	71.4	4.53	115.1	4.13	104.9	6.46	164.0	NS		UCF6-24		
UC-FL90-3224	36350-3224	20588738	2	50.8	1 1/2	2.37	60.3	5.24	133.1	5.24	133.1	8.23	209.0	NS		UCF6-32		
UC-FL90-3232	36350-3232	20242737	2	50.8	2	2.81	71.4	5.12	130.0	5.08	129.0	7.91	201.0	NS		UCF6-32		
UC-FL90-4024	36530-4024	20793532	2 1/2	63.5	1 1/2	2.37	60.3	5.06	128.6	5.55	140.9	8.80	223.5	NS		UCF6-40		
UC-FL90-4032	36530-4032	20793534	2 1/2	63.5	2	2.81	71.4	4.19	106.4	5.94	150.9	9.19	233.5	NS		UCF6-40		
UC-FL90-4040	36350-4040	20245157	2 1/2	63.5	2 1/2	3.31	84.1	5.75	146.0	6.30	160.0	9.55	242.5	NS		UCF6-40		



## Code 62 Flange (SAE J518)

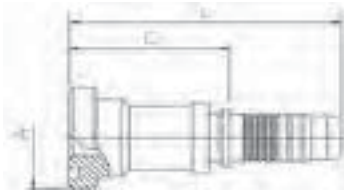

S=Skive  
NS=Non-Skive  
DG=Dual-Grip™

Descriptive #	Product #	SAP #	Hose Size ID		Flange Size	Flange Diameter (A)		Cut-Off (C)		Length (L)		Skive Type	SR3	HR4	SR6, HR6	SR14A
			in.	mm		in.	mm	in.	mm	in.	mm					
UC-FH-1212	36300-1212	20242607	3/4	19.0	3/4	1.63	41.3	2.07	52.6	3.62	92.0	NS	UCF6-12	UCF6-12	UCF2-12	UCF9-12
UC-FH-1216	36300-1216	20242467	3/4	19.0	1	1.87	47.6	2.19	55.5	3.74	95.0	NS	UCF6-12	UCF6-12	UCF2-12	UCF9-12
UC-FH-1616	36300-1616	20242647	1	25.4	1	1.87	47.6	2.20	55.9	4.00	101.5	NS	UCF6-16	UCF6-16		UCF9-16
UC-FH-1620	36300-1620	20242572	1	25.4	1¼	2.13	54.0	2.48	62.9	4.25	108.0	NS	UCF6-16	UCF6-16		UCF9-16
UC-FH-2020	36300-2020	20242659	1¼	31.8	1¼	2.13	54.0	3.20	81.3	5.32	135.0	NS		UCF6-20		
UC-FH-2024	36300-2024	20242419	1¼	31.8	1½	2.50	63.5	2.79	71.0	4.84	122.9	NS		UCF6-20		
UC-FH-2424	36300-2424	20242601	1½	38.1	1½	2.50	63.5	3.74	95.0	6.07	154.1	NS		UCF6-24		
UC-FH-3232	36300-3232	20242512	2	50.8	2	3.13	79.4	2.99	75.9	5.82	147.9	NS		UCF6-32		

## Code 62 Flange (SAE J518)

45° Elbow

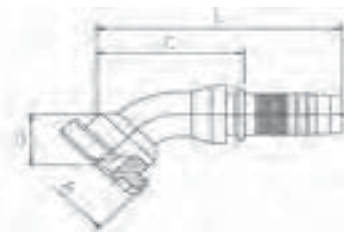

S=Skive  
NS=Non-Skive  
DG=Dual-Grip™

Descriptive #	Product #	SAP #	Hose Size ID		Flange Size	Flange Diameter (A)		Drop (D)		Cut-Off (C)		Length (L)		Skive Type	SR3	HR4	SR6, HR6	SR14A
			in.	mm		in.	mm	in.	mm	in.	mm	in.	mm					
UC-FH45-1212	36310-1212	20242570	3/4	19.0	3/4	1.63	41.3	1.22	31.0	3.31	84.1	4.86	123.5	NS	UCF6-12	UCF6-12	UCF2-12	UCF9-12
UC-FH45-1616	36310-1616	20242618	1	25.4	1	1.87	47.6	1.42	36.1	3.82	97.0	5.60	142.1	NS	UCF6-16	UCF6-16		UCF9-16
UC-FH45-1620	36310-1620	20242527	1	25.4	1¼	2.13	54.0	1.54	39.1	3.78	96.0	5.65	143.4	NS	UCF6-16	UCF6-16		UCF9-16
UC-FH45-2020	36310-2020	20242600	1¼	31.8	1¼	2.13	54.0	1.57	39.9	4.29	109.0	6.34	160.9	NS		UCF6-20		
UC-FH45-2424	36310-2424	20242517	1½	38.1	1½	2.50	63.5	1.77	45.0	4.84	122.9	7.17	182.1	NS		UCF6-24		
UC-FH45-3232	36310-3232	20242383	2	50.8	2	3.13	79.4	2.36	59.9	6.18	157.0	9.01	229.0	NS		UCF6-32		

# Code 62 Flange (SAE J518)

90° Elbow

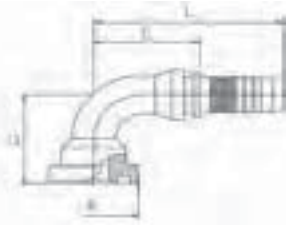

S=Skive  
NS=Non-Skive  
DG=Dual-Grip™

Descriptive #	Product #	SAP #	Hose Size ID		Flange Size		Flange Diameter (A)		Drop (D)		Cut-Off (C)		Length (L)		Skive Type	SR3	HR4	SR6, HR6	SR14A
			in.	mm	in.	mm	in.	mm	in.	mm	in.	mm	in.	mm					
UC-FH90-0808	36315-0808	20242306	1/2	12.7	1/2	1.25	31.8	1.81	46.0	1.89	48.0	3.32	84.3	NS	UCF6-08		UCF2-08	UCF9-08	
UC-FH90-1212	36315-1212	20242621	3/4	19.0	3/4	1.63	41.3	2.40	61.0	2.48	63.0	4.03	102.4	NS	UCF6-12	UCF6-12	UCF2-12	UCF9-12	
UC-FH90-1216	36315-1216	20242511	3/4	19.0	1	1.87	47.6	2.60	66.0	2.48	63.0	4.03	102.4	NS	UCF6-12	UCF6-12	UCF2-12	UCF9-12	
UC-FH90-1616	36315-1616	20242673	1	25.4	1	1.87	47.6	2.95	74.9	2.91	73.9	4.69	119.0	NS	UCF6-16	UCF6-16		UCF9-16	
UC-FH90-1620	36315-1620	20242585	1	25.4	1 1/4	2.13	54.0	3.07	78.0	3.07	78.0	4.85	123.1	NS	UCF6-16	UCF6-16		UCF9-16	
UC-FH90-2020	36315-2020	20242635	1 1/4	31.8	1 1/4	2.13	54.0	3.50	88.9	3.70	94.0	5.75	145.9	NS		UCF6-20			
UC-FH90-2024	36315-2024	20242418	1 1/4	31.8	1 1/2	2.50	63.5	3.70	94.0	3.86	98.0	5.91	150.0	NS		UCF6-20			
UC-FH90-2424	36315-2424	20242578	1 1/2	38.1	1 1/2	2.50	63.5	4.13	104.9	3.94	100.1	6.27	159.2	NS		UCF6-24			
UC-FH90-3232	36315-3232	20242487	2	50.8	2	3.13	79.4	5.20	132.1	5.63	143.0	8.46	215.0	NS		UCF6-32			

# BSPB (British Standard Pipe Parallel)

Female | Swivel

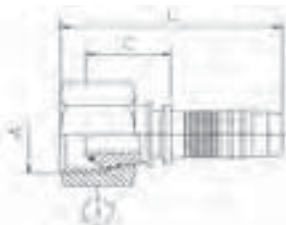

S=Skive  
NS=Non-Skive  
DG=Dual-Grip™

Descriptive #	Product #	SAP #	Hose Size ID		Thread Size (A)	Hex-1 Wrench Size	Cut-Off (C)		Length (L)		Skive Type	SR3	HR4	SR6, HR6	SR14A
			in.	mm			mm	in.	mm	in.					
UC-BPFX-0404	36105-0404	20242738	1/4	6.4	1/4-19	19	0.93	23.7	1.91	48.6	NS	UCF6-04		UCF2-04	UCF9-04
UC-BPFX-0406	36105-0406	20242462	1/4	6.4	3/8-19	22	1.09	27.6	2.07	52.5	NS	UCF6-04		UCF2-04	UCF9-04
UC-BPFX-0606	36105-0606	20242731	3/8	9.5	3/8-19	22	1.09	27.8	2.14	54.4	NS	UCF6-06		UCF2-06	UCF9-06
UC-BPFX-0608	36105-0608	20242557	3/8	9.5	1/2-14	27	1.20	30.4	2.24	57.0	NS	UCF6-06		UCF2-06	UCF9-06
UC-BPFX-0808	36105-0808	20242715	1/2	12.7	1/2-14	27	1.22	31.0	2.47	62.7	NS	UCF6-08		UCF2-08	UCF9-08
UC-BPFX-0810	36105-0810	20242406	1/2	12.7	5/8-14	27	1.48	37.6	2.73	69.3	NS	UCF6-08		UCF2-08	UCF9-08
UC-BPFX-1212 <sup>C</sup>	36105-1212	20242626	3/4	19.0	3/4-14	32	1.17	29.7	2.72	69.1	NS	UCF6-12	UCF6-12	UCF2-12	UCF9-12
UC-BPFX-1616 <sup>C</sup>	36105-1616	20242627	1	25.4	1-11	38	1.36	34.4	3.13	79.5	NS	UCF6-16	UCF6-16		UCF9-16
UC-BPFX-2020 <sup>T</sup>	36105-2020	20242483	1 1/4	31.8	1 1/4-11	50	1.69	42.8	3.73	94.8	NS		UCF6-20		
UC-BPFX-2424 <sup>T</sup>	36105-2424	20242806	1 1/2	38.1	1 1/2-11	55	1.80	45.8	4.13	105.0	NS		UCF6-24		
UC-BPFX-3232	36105-3232	20310550	2	50.8	2-11	70	1.98	50.2	4.81	122.2	NS		UCF6-32		

C: Crimp Nut T: Thrust-Wire Nut (see "Fitting Identification" in Appendix for details)

## BSPB (British Standard Pipe Parallel)

Female | 45° Elbow | Swivel

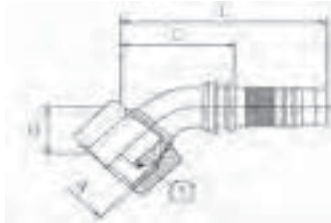

S=Skive  
NS=Non-Skive  
DG=Dual-Grip™

Descriptive #	Product #	SAP #	Hose Size ID		Thread Size (A)		Hex-1 Wrench Size		Drop (D)		Cut-Off (C)		Length (L)		Skive Type	SR3	HR4	SR6, HR6	SR14A
			in.	mm	in.	mm	in.	mm	in.	mm	in.	mm	in.	mm					
UC-BPFX45-0404	36115-0404	20242444	1/4	6.4	1/4-19	19	0.59	15.0	1.81	46.0	2.79	70.9	NS	UCF6-04		UCF2-04	UCF9-04	UCF9-03	
UC-BPFX45-0606	36115-0606	20242496	3/8	9.5	3/8-19	22	0.81	20.6	1.97	50.0	3.02	76.7	NS	UCF6-06		UCF2-06	UCF9-06	UCF9-04	
UC-BPFX45-0808	36115-0808	20242803	1/2	12.7	1/2-14	27	0.83	21.1	2.17	55.1	3.42	86.8	NS	UCF6-08		UCF2-08	UCF9-08	UCF9-05	
UC-BPFX45-1212 <sup>C</sup>	36115-1212	20242445	3/4	19.0	3/4-14	32	1.10	27.9	2.76	70.1	4.31	109.6	NS	UCF6-12	UCF6-12	UCF2-12	UCF9-12	UCF9-06	
UC-BPFX45-1616 <sup>C</sup>	36115-1616	20242801	1	25.4	1-11	38	1.34	34.0	3.31	84.1	5.09	129.2	NS	UCF6-16	UCF6-16		UCF9-16	UCF9-08	

C: Crimp Nut (see "Fitting Identification" in Appendix for details)

## BSPB (British Standard Pipe Parallel)

Female | 90° Elbow | Swivel

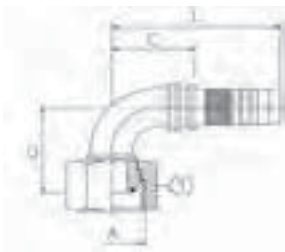

S=Skive  
NS=Non-Skive  
DG=Dual-Grip™

Descriptive #	Product #	SAP #	Hose Size ID		Thread Size (A)		Hex-1 Wrench Size		Drop (D)		Cut-Off (C)		Length (L)		Skive Type	SR3	HR4	SR6, HR6	SR14A
			in.	mm	in.	mm	in.	mm	in.	mm	in.	mm	in.	mm					
UC-BPFX90-0404	36120-0404	20242536	1/4	6.4	1/4-19	19	1.14	29.0	1.14	29.0	2.12	53.8	NS	UCF6-04		UCF2-04	UCF9-04	UCF9-03	
UC-BPFX90-0606	36120-0606	20242610	3/8	9.5	3/8-19	22	1.65	41.9	1.38	35.1	2.43	61.7	NS	UCF6-06		UCF2-06	UCF9-06	UCF9-04	
UC-BPFX90-0608	36120-0608	20242805	3/8	9.5	1/2-14	27	1.40	35.6	1.34	34.0	2.39	60.7	NS	UCF6-06		UCF2-06	UCF9-06		
UC-BPFX90-0808	36120-0808	20242556	1/2	12.7	1/2-14	27	1.61	40.9	1.42	36.1	2.67	67.7	NS	UCF6-08		UCF2-08	UCF9-08	UCF9-05	
UC-BPFX90-1212 <sup>C</sup>	36120-1212	20242546	3/4	19.0	3/4-14	32	2.09	53.1	1.93	49.0	3.48	88.5	NS	UCF6-12	UCF6-12	UCF2-12	UCF9-12	UCF9-06	
UC-BPFX90-1616 <sup>C</sup>	36120-1616	20242515	1	25.4	1-11	38	2.72	69.1	2.95	74.9	4.73	120.0	NS	UCF6-16	UCF6-16		UCF9-16	UCF9-08	
UC-BPFX90-2020 <sup>T</sup>	36120-2020	20242374	1 1/4	31.8	1 1/4-11	50	3.27	83.1	3.23	82.0	5.28	134.1	NS		UCF6-20			UCF9-06	

C: Crimp Nut T: Thrust-Wire Nut (see "Fitting Identification" in Appendix for details)

## BSPP (British Standard Pipe Parallel)

Male

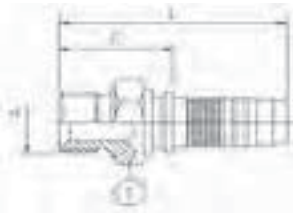

S=Skive  
NS=Non-Skive  
DG=Dual-Grip™

Descriptive #	Product #	SAP #	Hose Size ID		Thread Size (A)	Hex-1 Wrench Size	Cut-Off (C)		Length (L)		Skive Type	SR3	HR4	SR6, HR6	SR14A
			in.	mm			mm	in.	mm	in.					
UC-BPM-0404	36130-0404	20242484	1/4	6.4	1/4-19	19	1.03	26.2	2.01	51.1	NS	UCF6-04		UCF2-04	UCF9-04
UC-BPM-0606	36130-0606	20242581	3/8	9.5	3/8-19	22	1.10	28.0	2.15	54.6	NS	UCF6-06		UCF2-06	UCF9-06
UC-BPM-0608	36130-0608	20242464	3/8	9.5	1/2-14	27	1.24	31.5	2.29	58.1	NS	UCF6-06		UCF2-06	UCF9-06
UC-BPM-0806	36130-0806	20242809	1/2	12.7	3/8-19	22	1.12	28.5	2.37	60.2	NS	UCF6-08		UCF2-08	UCF9-08
UC-BPM-0808	36130-0808	20242463	1/2	12.7	1/2-14	27	1.26	32.0	2.51	63.7	NS	UCF6-08		UCF2-08	UCF9-08
UC-BPM-1212	36130-1212	20242407	3/4	19.0	3/4-14	32	1.45	36.7	3.00	76.1	NS	UCF6-12	UCF6-12	UCF2-12	UCF9-12
UC-BPM-1616	36130-1616	20242807	1	25.4	1-11	41	1.69	43.0	3.47	88.1	NS	UCF6-16	UCF6-16		UCF9-16
UC-BPM-2020	36130-2020	20242808	1 1/4	31.8	1 1/4-11	50	1.89	48.0	3.94	100.0	NS		UCF6-20		

## BSPT (British Standard Pipe Tapered)

Male

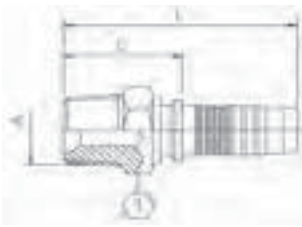

S=Skive  
NS=Non-Skive  
DG=Dual-Grip™

Descriptive #	Product #	SAP #	Hose Size ID		Thread Size (A)	Hex-1 Wrench Size	Cut-Off (C)		Length (L)		Skive Type	SR3	HR4	SR6, HR6	SR14A
			in.	mm			mm	in.	mm	in.					
UC-BTM-0404	36170-0404	20242611	1/4	6.4	1/4-19	17	1.06	27.0	2.04	51.9	NS	UCF6-04		UCF2-04	UCF9-04
UC-BTM-0606	36170-0606	20242612	3/8	9.5	3/8-19	19	1.10	27.9	2.15	54.6	NS	UCF6-06		UCF2-06	UCF9-06
UC-BTM-0808	36170-0808	20242507	1/2	12.7	1/2-14	22	1.31	33.1	2.55	64.8	NS	UCF6-08		UCF2-08	UCF9-08
UC-BTM-1212	36170-1212	20242409	3/4	19.0	3/4-14	27	1.36	34.6	2.92	74.1	NS	UCF6-12	UCF6-12	UCF2-12	UCF9-12
UC-BTM-1616	36170-1616	20242408	1	25.4	1-11	36	1.73	43.9	3.51	89.0	NS	UCF6-16	UCF6-16		UCF9-16

## BSP Flat Seat (British Standard Pipe)

Female | Swivel



S=Skive  
NS=Non-Skive  
DG=Dual-Grip™

Descriptive #	Product #	SAP #	Hose Size ID		Thread Size (A)	Hex-1 Wrench Size	Cut-Off (C)		Length (L)		Skive Type	SR3	HR4	SR6, HR6	SR14A
			in.	mm			mm	in.	mm	in.					
UC-BFFX-0606	36100-0606	20242800	3/8	9.5	3/8-19	22	0.75	19.0	1.80	45.6	NS	UCF6-06		UCF2-06	UCF9-06
UC-BFFX-0608	36100-0608	20242799	3/8	9.5	1/2-14	27	0.80	20.2	1.84	46.8	NS	UCF6-06		UCF2-06	UCF9-06
UC-BFFX-0808	36100-0808	20242798	1/2	12.7	1/2-14	27	0.82	20.9	2.07	52.5	NS	UCF6-08		UCF2-08	UCF9-08
UC-BFFX-0812	36100-0812	20242285	1/2	12.7	3/4-14	32	0.97	24.5	2.21	56.2	NS	UCF6-08		UCF2-08	UCF9-08

## DIN 24° Light

Female | Swivel



S=Skive  
NS=Non-Skive  
DG=Dual-Grip™

Descriptive #	Product #	SAP #	Hose Size ID		Thread Size (A)	Hex-1 Wrench Size	Cut-Off (C)		Length (L)		Skive Type	SR3	HR4	SR6, HR6	SR14A
			in.	mm			mm	in.	mm	in.					
UC-DLFX-0412 <sup>T</sup>	36240-0412	20242540	1/4	6.4	12x1.5	14	1.07	27.2	2.05	52.0	NS	UCF6-04		UCF2-04	UCF9-04
UC-DLFX-0414	36240-0414	20242594	1/4	6.4	14x1.5	17	1.02	25.9	2.00	50.8	NS	UCF6-04		UCF2-04	UCF9-04
UC-DLFX-0416	36240-0416	20242471	1/4	6.4	16x1.5	19	1.08	27.4	2.06	52.2	NS	UCF6-04		UCF2-04	UCF9-04
UC-DLFX-0616	36240-0616	20242658	3/8	9.5	16x1.5	19	2.21	56.2	2.26	57.5	NS	UCF6-06		UCF2-06	UCF9-06
UC-DLFX-0618	36240-0618	20242641	3/8	9.5	18x1.5	22	1.08	27.5	2.13	54.2	NS	UCF6-06		UCF2-06	UCF9-06
UC-DLFX-0822	36240-0822	20242586	1/2	12.7	22x1.5	27	1.21	30.7	2.46	62.4	NS	UCF6-08		UCF2-08	UCF9-08
UC-DLFX-1230	36240-1230	20242501	3/4	19.0	30x2.0	36	1.42	36.0	2.97	75.4	NS	UCF6-12	UCF6-12	UCF2-12	UCF9-12
UC-DLFX-1636	36240-1636	20242453	1	25.4	36x2.0	41	1.49	37.9	3.27	83.0	NS	UCF6-16	UCF6-16		UCF9-16
UC-DLFX-2045	36240-2045	20242539	1 1/4	31.8	45x2.0	50	1.74	44.1	3.78	96.1	NS		UCF6-20		
UC-DLFX-3252	36240-3252	20588739	2	50.8	52X2.0	60	1.46	37.0	4.29	109.0	NS		UCF6-20		

T: Thrust-Wire Nut (see "Fitting Identification" in Appendix for details)

## DIN 24° Light

Female | 45° Elbow | Swivel

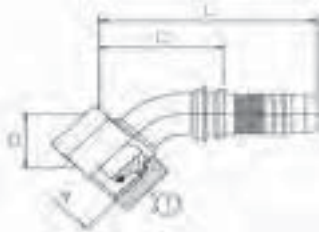

S=Skive  
NS=Non-Skive  
DG=Dual-Grip™

Descriptive #	Product #	SAP #	Hose Size ID		Thread Size (A)	Hex-1 Wrench Size	Drop (D)		Cut-Off (C)		Length (L)		Skive Type	SR3	HR4	SR6, HR6	SR14A
			in.	mm			mm	in.	mm	in.	mm	in.					
UC-DLFX45-0414 <sup>T</sup>	36245-0414	20242385	1/4	6.4	14x1.5	17	0.69	17.5	1.69	42.9	2.67	67.8	NS	UCF6-04		UCF2-04	UCF9-04
UC-DLFX45-0416	36245-0416	20242386	1/4	6.4	16x1.5	19	0.79	20.1	1.65	41.9	2.63	66.8	NS	UCF6-04		UCF2-04	UCF9-04
UC-DLFX45-0618	36245-0618	20242387	3/8	9.5	18x1.5	22	0.77	19.6	1.85	47.0	2.90	73.6	NS	UCF6-06		UCF2-06	UCF9-06
UC-DLFX45-0822	36245-0822	20242329	1/2	12.7	22x1.5	27	0.83	21.1	2.17	55.1	3.15	79.9	NS	UCF6-08		UCF2-08	UCF9-08
UC-DLFX45-1230	36245-1230	20242330	3/4	19.0	30x2.0	36	1.26	32.0	2.72	69.1	4.27	108.5	NS	UCF6-12	UCF6-12	UCF2-12	UCF9-12
UC-DLFX45-1636	36245-1636	20242328	1	25.4	36x2.0	41	1.26	32.0	3.58	90.9	5.36	136.0	NS	UCF6-16	UCF6-16		UCF9-16

T: Thrust-Wire Nut (see "Fitting Identification" in Appendix for details)

## DIN 24° Light

Female | 90° Elbow | Swivel

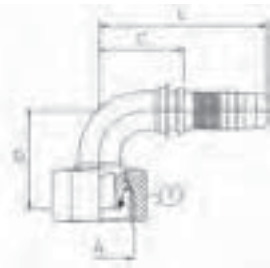

S=Skive  
NS=Non-Skive  
DG=Dual-Grip™

Descriptive #	Product #	SAP #	Hose Size ID		Thread Size (A)	Hex-1 Wrench Size	Drop (D)		Cut-Off (C)		Length (L)		Skive Type	SR3	HR4	SR6, HR6	SR14A
			in.	mm			mm	in.	mm	in.	mm	in.					
UC-DLFX90-0412	36250-0412	20242390	1/4	6.4	12x1.5	14	1.02	25.9	1.14	29.0	2.12	53.8	NS	UCF6-04		UCF2-04	UCF9-04
UC-DLFX90-0414	36250-0414	20242425	1/4	6.4	14x1.5	17	1.28	32.5	1.10	27.9	2.08	52.8	NS	UCF6-04		UCF2-04	UCF9-04
UC-DLFX90-0416	36250-0416	20242391	1/4	6.4	16x1.5	19	1.28	32.5	1.10	27.9	2.08	52.8	NS	UCF6-04		UCF2-04	UCF9-04
UC-DLFX90-0618	36250-0618	20242488	3/8	9.5	18x1.5	22	1.54	39.1	1.30	33.0	2.35	59.7	NS	UCF6-06		UCF2-06	UCF9-06
UC-DLFX90-0822	36250-0822	20242389	1/2	12.7	22x1.5	27	1.59	40.4	1.57	39.9	2.82	71.6	NS	UCF6-08		UCF2-08	UCF9-08
UC-DLFX90-1230	36250-1230	20242332	3/4	19.0	30x2.0	36	2.32	58.9	2.05	52.1	3.60	91.5	NS	UCF6-12	UCF6-12	UCF2-12	UCF9-12
UC-DLFX90-1636	36250-1636	20242331	1	25.4	36x2.0	41	2.68	68.1	3.07	78.0	4.85	123.1	NS	UCF6-16	UCF6-16		UCF9-16
UC-DLFX90-2045	36250-2045	20242388	1 1/4	31.8	45x2.0	50	3.50	88.9	3.54	89.9	5.59	141.9	NS		UCF6-20		

# DIN 24° Light

Male

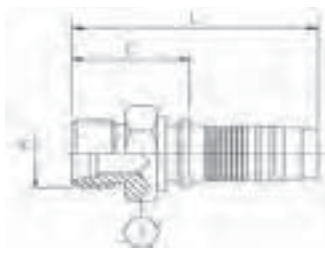

S=Skive  
NS=Non-Skive  
DG=Dual-Grip™

Descriptive #	Product #	SAP #	Hose Size ID		Thread Size (A)	Hex-1 Wrench Size	Cut-Off (C)		Length (L)		Skive Type	SR3	HR4	SR6, HR6	SR14A
			in.	mm			in.	mm	in.	mm					
UC-DLM-0412	36255-0412	20242334	1/4	6.4	12x1.5	14	0.84	21.4	1.82	46.3	NS	UCF6-04		UCF2-04	UCF9-04
UC-DLM-0414	36255-0414	20242393	1/4	6.4	14x1.5	14	0.84	21.4	1.82	46.3	NS	UCF6-04		UCF2-04	UCF9-04
UC-DLM-0416	36255-0416	20242335	1/4	6.4	16x1.5	17	0.92	23.4	1.90	48.3	NS	UCF6-04		UCF2-04	UCF9-04
UC-DLM-0616	36255-0616	20242426	3/8	9.5	16x1.5	17	0.93	23.6	1.98	50.2	NS	UCF6-06		UCF2-06	UCF9-06
UC-DLM-0618	36255-0618	20242513	3/8	9.5	18x1.5	19	0.96	24.4	2.01	51.1	NS	UCF6-06		UCF2-06	UCF9-06
UC-DLM-0822	36255-0822	20242392	1/2	12.7	22x1.5	22	1.02	26.0	2.27	57.6	NS	UCF6-08		UCF2-08	UCF9-08
UC-DLM-1230	36255-1230	20242336	3/4	19.0	30x2.0	32	1.24	31.5	2.79	70.9	NS	UCF6-12	UCF6-12	UCF2-12	UCF9-12
UC-DLM-1636	36255-1636	20242333	1	25.4	36x2.0	36	1.34	34.1	3.12	79.1	NS	UCF6-16	UCF6-16		UCF9-16

# DIN 24° Heavy

Female | Swivel



S=Skive  
NS=Non-Skive  
DG=Dual-Grip™

Descriptive #	Product #	SAP #	Hose Size ID		Thread Size (A)	Hex-1 Wrench Size	Cut-Off (C)		Length (L)		Skive Type	SR3	HR4	SR6, HR6	SR14A
			in.	mm			in.	mm	in.	mm					
UC-DHFX-0416	36210-0416	20242538	1/4	6.4	16x1.5	19	1.20	30.5	2.18	55.4	NS	UCF6-04		UCF2-04	UCF9-04
UC-DHFX-0418	36210-0418	20242529	1/4	6.4	18x1.5	22	1.21	30.8	2.19	55.7	NS	UCF6-04		UCF2-04	UCF9-04
UC-DHFX-0620	36210-0620	20242624	3/8	9.5	20x1.5	24	1.21	30.8	2.26	57.4	NS	UCF6-06		UCF2-06	UCF9-06
UC-DHFX-0622	36210-0622	20242562	3/8	9.5	22x1.5	27	1.42	36.2	2.47	62.8	NS	UCF6-06		UCF2-06	UCF9-06
UC-DHFX-0824	36210-0824	20242561	1/2	12.7	24x1.5	30	1.44	36.5	2.68	68.2	NS	UCF6-08		UCF2-08	UCF9-08
UC-DHFX-1230T	36210-1230	20242319	3/4	19.0	30x2.0	36	1.62	41.0	3.17	80.5	NS	UCF6-12	UCF6-12	UCF2-12	UCF9-12
UC-DHFX-1236	36210-1236	20242530	3/4	19.0	36x2.0	46	1.89	47.9	3.44	87.4	NS	UCF6-12	UCF6-12	UCF2-12	UCF9-12
UC-DHFX-1236S	36210-1236S	20608762	3/4	19.0	36x2.0	46	1.89	47.9	3.44	87.4	NS	UCF6-12	UCF6-12	UCF2-12	UCF9-12
UC-DHFX-1642	36210-1642	20242500	1	25.4	42x2.0	50	1.88	47.9	3.66	92.9	NS	UCF6-16	UCF6-16		UCF9-16

T: Thrust-Wire Nut (see "Fitting Identification" in Appendix for details)

S: Stainless Steel

# DIN 24° Heavy

Female | 45° Elbow | Swivel

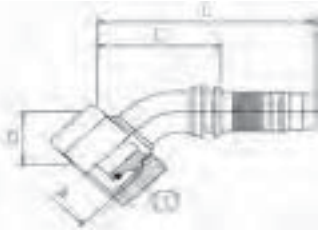

S=Skive  
NS=Non-Skive  
DG=Dual-Grip™

Descriptive #	Product #	SAP #	Hose Size ID		Thread Size (A)	Hex-1 Wrench Size	Drop (D)		Cut-Off (C)		Length (L)		Skive Type	SR3	HR4	SR6, HR6	SR14A
			in.	mm			mm	in.	mm	in.	mm	in.					
UC-DHFX45-0418	36215-0418	20242313	1/4	6.4	18x1.5	22	0.75	19.1	1.69	42.9	2.67	67.8	NS	UCF6-04		UCF2-04	UCF9-04
UC-DHFX45-0620	36215-0620	20242315	3/8	9.5	20x1.5	24	0.79	20.1	2.01	51.1	3.06	77.7	NS	UCF6-06		UCF2-06	UCF9-06
UC-DHFX45-0622	36215-0622	20242316	3/8	9.5	22x1.5	27	0.83	21.1	2.09	53.1	3.14	79.7	NS	UCF6-06		UCF2-06	UCF9-06
UC-DHFX45-0824	36215-0824	20242312	1/2	12.7	24x1.5	30	0.85	21.6	2.20	55.9	3.45	87.6	NS	UCF6-08		UCF2-08	UCF9-08
UC-DHFX45-1236	36215-1236	20242314	3/4	19.0	36x2.0	46	1.30	33.0	2.72	69.1	4.27	108.5	NS	UCF6-12	UCF6-12	UCF2-12	UCF9-12
UC-DHFX45-1642	36215-1642	20242310	1	25.4	42x2.0	50	1.59	40.4	4.33	110.0	6.11	155.1	NS	UCF6-16	UCF6-16		UCF9-16

# DIN 24° Heavy

Female | 90° Elbow | Swivel

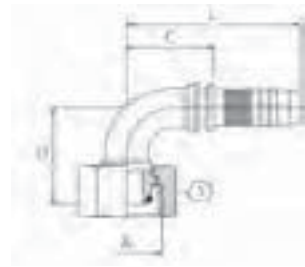

S=Skive  
NS=Non-Skive  
DG=Dual-Grip™

Descriptive #	Product #	SAP #	Hose Size ID		Thread Size (A)	Hex-1 Wrench Size	Drop (D)		Cut-Off (C)		Length (L)		Skive Type	SR3	HR4	SR6, HR6	SR14A
			in.	mm			mm	in.	mm	in.	mm	in.					
UC-DHFX90-0418	36220-0418	20242421	1/4	6.4	18x1.5	22	1.34	34.0	1.06	26.9	2.04	51.8	NS	UCF6-04		UCF2-04	UCF9-04
UC-DHFX90-0620	36220-0620	20242563	3/8	9.5	20x1.5	24	1.52	38.6	1.34	34.0	2.39	60.7	NS	UCF6-06		UCF2-06	UCF9-06
UC-DHFX90-0622	36220-0622	20242469	3/8	9.5	22x1.5	27	1.59	40.4	1.34	34.0	2.39	60.7	NS	UCF6-06		UCF2-06	UCF9-06
UC-DHFX90-0824	36220-0824	20242468	1/2	12.7	24x1.5	30	1.63	41.4	1.57	39.9	2.82	71.6	NS	UCF6-08		UCF2-08	UCF9-08
UC-DHFX90-1236	36220-1236	20242317	3/4	19.0	36x2.0	46	2.34	59.4	2.01	51.1	3.56	90.5	NS	UCF6-12	UCF6-12	UCF2-12	UCF9-12
UC-DHFX90-1236S	36220-1236S	20608763	3/4	19.0	36x2.0	46	2.34	59.4	2.01	51.1	3.56	90.5	NS	UCF6-12	UCF6-12	UCF2-12	UCF9-12
UC-DHFX90-1642	36220-1642	20242420	1	25.4	42x2.0	50	3.11	79.0	2.99	75.9	4.77	121.0	NS	UCF6-16	UCF6-16		UCF9-16

S: Stainless Steel



# DIN 24° Heavy

Male



S=Skive  
NS=Non-Skive  
DG=Dual-Grip™

Descriptive #	Product #	SAP #	Hose Size ID		Thread Size (A)	Hex-1 Wrench Size	Cut-Off (C)		Length (L)		Skive Type	SR3	HR4	SR6, HR6	SR14A
			in.	mm			mm	in.	mm	in.					
UC-DHM-0416	36225-0416	20242323	1/4	6.4	16x1.5	17	0.95	24.2	1.93	49.1	NS	UCF6-04		UCF2-04	UCF9-04
UC-DHM-0418	36225-0418	20242324	1/4	6.4	18x1.5	19	0.99	25.2	1.97	50.1	NS	UCF6-04		UCF2-04	UCF9-04
UC-DHM-0620	36225-0620	20242424	3/8	9.5	20x1.5	22	1.00	25.4	2.05	52.1	NS	UCF6-06		UCF2-06	UCF9-06
UC-DHM-0622	36225-0622	20242470	3/8	9.5	22x1.5	22	1.08	27.4	2.13	54.1	NS	UCF6-06		UCF2-06	UCF9-06
UC-DHM-0824	36225-0824	20242322	1/2	12.7	24x1.5	24	1.14	29.0	2.39	60.7	NS	UCF6-08		UCF2-08	UCF9-08
UC-DHM-1230	36225-1230	20242325	3/4	19.0	30x2.0	32	1.33	33.7	2.88	73.1	NS	UCF6-12	UCF6-12	UCF2-12	UCF9-12
UC-DHM-1236	36225-1236	20242326	3/4	19.0	36x2.0	36	1.48	37.7	3.04	77.1	NS	UCF6-12	UCF6-12	UCF2-12	UCF9-12
UC-DHM-1642	36225-1642	20242321	1	25.4	42x2.0	46	1.66	42.1	3.43	87.2	NS	UCF6-16	UCF6-16		UCF9-16

# DIN 60°

Female | 45° Elbow | Swivel

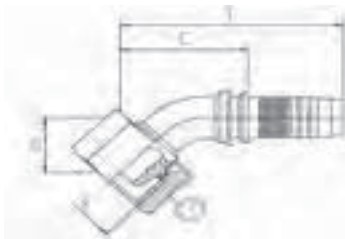

S=Skive  
NS=Non-Skive  
DG=Dual-Grip™

Descriptive #	Product #	SAP #	Hose Size ID		Thread Size (A)	Hex-1 Wrench Size	Drop (D)	Cut-Off (C)		Length (L)		Skive Type	SR3	HR4	SR6, HR6	SR14A	
			in.	mm				mm	in.	mm	in.						mm
UC-DNFX45-0414	36275-0414	20242338	1/4	6.4	14x1.5	17	0.63	16.0	1.38	35.1	2.36	59.9	NS	UCF6-04		UCF2-04	UCF9-04
UC-DNFX45-0416	36275-0416	20242339	1/4	6.4	16x1.5	19	0.67	17.0	1.42	36.1	2.40	61.0	NS	UCF6-04		UCF2-04	UCF9-04
UC-DNFX45-0618	36275-0618	20242340	3/8	9.5	18x1.5	22	0.77	19.6	1.69	42.9	2.74	69.6	NS	UCF6-06		UCF2-06	UCF9-06
UC-DNFX45-0822	36275-0822	20242337	1/2	12.7	22x1.5	27	0.79	20.1	2.17	55.1	3.42	86.8	NS	UCF6-08		UCF2-08	UCF9-08

## DIN 60°

Female | 90° Elbow | Swivel

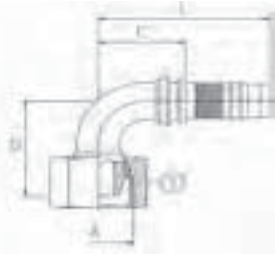

S=Skive  
NS=Non-Skive  
DG=Dual-Grip™

Descriptive #	Product #	SAP #	Hose Size ID		Thread Size (A)	Hex-1 Wrench Size	Drop (D)		Cut-Off (C)		Length (L)		Skive Type	SR3	HR4	SR6, HR6	SR14A
			in.	mm			mm	in.	mm	in.	mm	in.					
UC-DNFX90-0414	36280-0414	20242428	1/4	6.4	14x1.5	17	1.28	32.5	1.18	30.0	2.16	54.9	NS	UCF6-04		UCF2-04	UCF9-04
UC-DNFX90-0416	36280-0416	20242341	1/4	6.4	16x1.5	19	1.28	32.5	1.10	27.9	2.08	52.8	NS	UCF6-04		UCF2-04	UCF9-04
UC-DNFX90-0616	36280-0616	20242342	3/8	9.5	16x1.5	19	1.26	32.0	1.18	30.0	2.23	56.6	NS	UCF6-06		UCF2-06	UCF9-06
UC-DNFX90-0618	36280-0618	20242472	3/8	9.5	18x1.5	22	1.46	37.1	1.30	33.0	2.35	59.7	NS	UCF6-06		UCF2-06	UCF9-06
UC-DNFX90-0822	36280-0822	20242427	1/2	12.7	22x1.5	27	1.57	39.9	1.57	39.9	2.82	71.6	NS	UCF6-08		UCF2-08	UCF9-08

## Japanese Komatsu® 30° Flare with Metric Threads

Female | Swivel

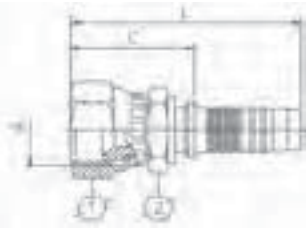

S=Skive  
NS=Non-Skive  
DG=Dual-Grip™

Descriptive #	Product #	SAP #	Hose Size ID		Thread Size (A)	Hex-1 Wrench Size	Hex-2 Wrench Size	Cut-Off (C)		Length (L)		Skive Type	SR3	HR4	SR6, HR6	SR14A
			in.	mm				mm	mm	in.	mm					
UC-KMFX-0414	36545-0414	20242590	1/4	6.4	14X1.5	19	17	1.22	30.9	2.20	55.8	NS	UCF6-04		UCF2-04	UCF9-04
UC-KMFX-0618	36545-0618	20242636	3/8	9.5	18X1.5	22	19	1.26	32.1	2.31	58.7	NS	UCF6-06		UCF2-06	UCF9-06
UC-KMFX-0822	36545-0822	20242573	1/2	12.7	22X1.5	27	22	1.38	35.2	2.63	66.8	NS	UCF6-08		UCF2-08	UCF9-08
UC-KMFX-1024	36545-1024	20283390	5/8	15.9	24x1.5	32	30	1.66	42.2	3.02	76.6	NS	UCF6-10		UCF2-10	UCF9-10
UC-KMFX-1230	36545-1230	20242541	3/4	19.0	30x1.5	36	30	1.84	46.7	3.39	86.1	NS	UCF6-12	UCF6-12	UCF2-12	UCF9-12
UC-KMFX-1633	36545-1633	20242564	1	25.4	33x1.5	41	36	2.24	56.9	4.02	102.0	NS	UCF6-16	UCF6-16		UCF9-16
UC-KMFX-2036	36545-2036	20242394	1 1/4	31.8	36x1.5	46	46	2.50	63.6	4.55	115.5	NS		UCF6-20		

## Japanese Komatsu® 30° Flare with Metric Threads Female | 45° Elbow | Swivel



S=Skive  
NS=Non-Skive  
DG=Dual-Grip™

Descriptive #	Product #	SAP #	Hose Size ID		Thread Size (A)	Hex-1 Wrench Size	Drop (D)		Cut-Off (C)		Length (L)		Skive Type		SR3	HR4	SR6, HR6	SR14A
			in.	mm	mm	in.	mm	in.	mm	in.	mm	in.	mm	NS	UCF6-04	UCF2-04	UCF9-04	
UC-KMFX45-0414	36548-0414	20318233	1/4	6.4	14X1.5	19	0.61	15.5	1.50	38.1	2.48	63.0	NS	UCF6-04		UCF2-04	UCF9-04	
UC-KMFX45-0618	36548-0618	20318234	3/8	9.5	18X1.5	22	0.71	18.0	1.73	43.9	2.78	70.6	NS	UCF6-06		UCF2-06	UCF9-06	
UC-KMFX45-0822	36548-0822	20318235	1/2	12.7	22X1.5	27	1.16	29.5	2.20	55.9	3.45	87.6	NS	UCF6-08		UCF2-08	UCF9-08	

## Japanese Komatsu® 30° Flare with Metric Threads Female | 90° Elbow | Swivel

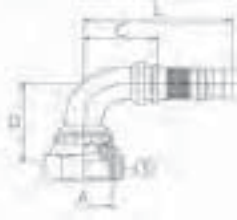

S=Skive  
NS=Non-Skive  
DG=Dual-Grip™

Descriptive #	Product #	SAP #	Hose Size ID		Thread Size (A)	Hex-1 Wrench Size	Drop (D)		Cut-Off (C)		Length (L)		Skive Type		SR3	HR4	SR6, HR6	SR14A
			in.	mm	mm	in.	mm	in.	mm	in.	mm	in.	mm	NS	UCF6-04	UCF2-04	UCF9-04	
UC-KMFX90-0414	36550-0414	20318236	1/4	6.4	14X1.5	19	1.16	29.5	1.30	33.0	2.28	57.9	NS	UCF6-04		UCF2-04	UCF9-04	
UC-KMFX90-0618	36550-0618	20318326	3/8	9.5	18X1.5	22	1.40	35.6	1.42	36.0	2.47	62.7	NS	UCF6-06		UCF2-06	UCF9-06	
UC-KMFX90-0822	36550-0822	20318327	1/2	12.7	22X1.5	27	2.09	53.1	1.74	37.0	2.98	75.8	NS	UCF6-08		UCF2-08	UCF9-08	

## JIS 30° (Parallel Pipe Threads)

Female | Swivel

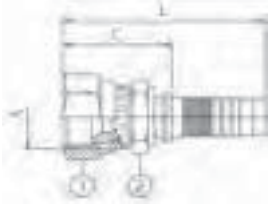

S=Skive  
NS=Non-Skive  
DG=Dual-Grip™

Descriptive #	Product #	SAP #	Hose Size ID		Thread Size (A)	Hex-1 Wrench Size	Hex-2 Wrench Size	Cut-Off (C)		Length (L)		Skive Type		SR3	HR4	SR6, HR6	SR14A
			in.	mm	mm	mm	in.	mm	in.	mm	in.	mm	NS	UCF6-04	UCF2-04	UCF9-04	
UC-JSFX-0404	36520-0404	20242644	1/4	6.4	1/4-19	19	17	1.22	30.9	2.20	55.8	NS	UCF6-04		UCF2-04	UCF9-04	
UC-JSFX-0606	36520-0606	20242699	3/8	9.5	3/8-19	22	19	1.26	32.1	2.31	58.7	NS	UCF6-06		UCF2-06	UCF9-06	
UC-JSFX-0808	36520-0808	20242606	1/2	12.7	1/2-14	27	22	1.39	35.2	2.63	66.9	NS	UCF6-08		UCF2-08	UCF9-08	
UC-JSFX-1212	36520-1212	20242543	3/4	19.0	3/4-14	36	30	1.58	40.2	3.14	79.6	NS	UCF6-12	UCF6-12	UCF2-12	UCF9-12	
UC-JSFX-1616	36520-1616	20242502	1	25.4	1-11	41	36	1.87	47.5	3.65	92.6	NS	UCF6-16	UCF6-16		UCF9-16	
UC-JSFX-2020T	36520-2020	20242436	1 1/4	31.8	1 1/4-11	50	46	2.16	54.9	4.21	106.9	NS		UCF6-20			

T: Thrust-Wire Nut (see "Fitting Identification" in Appendix for details)

# How to Use the Fitting Tables

This section lists ALL fittings that are compatible with the following hoses:

Hose Family	Hose Descriptive
SR5	SAE 100R5
DR5	SAE 100R5 (High Temp)
SCX5	SAE 100R5 (Rubber Covered)

## Fitting Description

## Fitting Type

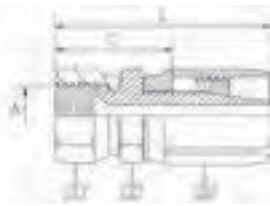

Descriptive #	Product #	SAP #	Hose Size ID		Thread Size (A)	Hex-1 Wrench Size		Hex-2 Wrench Size		Socket (S) Wrench Size		Cut-Off (C)		Length (L)	SR5, DR5
			in.	mm		in.	in.	in.	in.	in.	mm	in.	mm		
Field Grip, PN1	18400-0404	20245798	3/16	4.8	7/16-20	9/16	9/16	5/8	1.19	30.2	1.94	49.2	Y		
Field Grip, PN2	18400-0505	20245799	1/4	6.4	1/2-20	5/8	5/8	11/16	1.30	32.9	2.08	52.8	Y		
Field Grip, PN3	18400-0606	20245800	5/16	7.9	9/16-18	11/16	11/16	13/16	1.41	35.7	2.31	58.7	Y		

A “Y” in the hose compatibility columns indicates that the fitting is a **Field Grip™** style fitting and that it works for that particular hose.

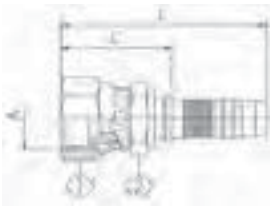

Descriptive #	Product #	SAP #	Hose Size ID		Thread Size (A)	Hex-1 Wrench Size		Hex-2 Wrench Size		Socket (S) Wrench Size		Length (L)		SR5, DR5, SCX5	
			in.	mm		in.	mm	in.	in.	in.	mm	in.	mm		
Uni-Crimp, PN1	36400-0304	20557173	3/16	4.8	7/16-20	9/16	14	1/2	12	N/A	0.71	18.1	1.93	49.0	UCF6-03
Uni-Crimp, PN2	36400-0404	20242786	1/4	6.4	7/16-20	5/8	16	9/16	14	N/A	0.77	19.6	2.09	53.1	UCF6-04
Uni-Crimp, PN3	36400-0404S	20540685	1/4	6.4	7/16-20	5/8	16	9/16	14	N/A	0.77	19.6	2.09	53.1	Uni-Crimp Ferrule PN

Choose fittings carefully, considering the working pressure of both hose and fitting. The maximum working pressure of the hose assembly is the lesser of the rated working pressure of the hose and the fitting. See page 300 for working pressure.

A **Part Number (Ferrule)** in the hose compatibility columns indicates that the fitting is a **Uni-Crimp™** or **Dual Grip™** style. The fitting, along with the Ferrule shown, work together as a unit for that particular hose.

# JIC 37° Flare (SAE J514)

Female | Swivel

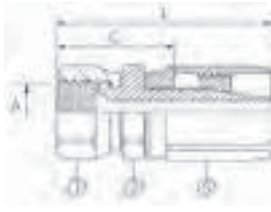

Descriptive #	Product #	SAP #	Hose Size ID		Thread Size (A)	Hex-1 Wrench Size		Hex-2 Wrench Size		Socket (S) Wrench Size		Cut-Off (C)		Length (L)		SR5, DR5
			in.	mm	in.	in.	in.	in.	in.	in.	mm	in.	mm			
FG-JCFX-0404	18400-0404	20245798	3/16	4.8	7/16-20	9/16	9/16	5/8	1.19	30.2	1.94	49.2	Y			
FG-JCFX-0505	18400-0505	20245799	1/4	6.4	1/2-20	5/8	5/8	11/16	1.30	32.9	2.08	52.8	Y			
FG-JCFX-0606	18400-0606	20245800	5/16	7.9	9/16-18	11/16	11/16	13/16	1.41	35.7	2.31	58.7	Y			
FG-JCFX-0808	18400-0808	20245801	13/32	10.3	3/4-16	7/8	7/8	15/16	1.58	40.1	2.68	68.1	Y			
FG-JCFX-1010	18400-1010	20245792	1/2	12.7	7/8-14	1	1	1 1/8	1.67	42.5	3.06	77.8	Y			
FG-JCFX-1212	18400-1212	20245793	5/8	15.9	1 1/16-12	1 1/4	1 1/4	1 1/4	1.92	48.8	3.50	88.9	Y			
FG-JCFX-1616	18400-1616	20245794	7/8	22.2	1 5/16-12	1 1/2	1 1/2	1 7/16	1.92	48.8	3.19	81.0	Y			
FG-JCFX-2020	18400-2020	20245795	1 1/8	28.6	1 5/8-12	2	2	1 3/4	2.50	63.5	3.38	85.7	Y			
FG-JCFX-2424	18400-2424	20245796	1 3/8	34.9	1 7/8-12	2 1/4	2 1/4	2	2.23	56.8	3.66	92.9	Y			
FG-JCFX-3232	18400-3232	20245797	1 3/16	46.0	2 1/2-12	2 7/8	2 7/8	2 1/2	2.58	65.5	4.44	112.7	Y			

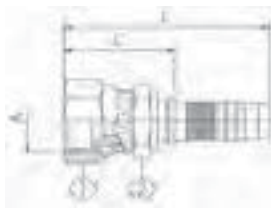

Descriptive #	Product #	SAP #	Hose Size ID		Thread Size (A)	Hex-1 Wrench Size		Hex-2 Wrench Size		Socket (S) Wrench Size		Cut-Off (C)		Length (L)		SR5, DR5, SCX5
			in.	mm	in.	mm	in.	mm	in.	mm	in.	mm	in.	mm		
UCH-JCFX-0304		20530659	3/16	4.8	7/16-20	5/8	16	9/16	14	N/A	1.07	27.2	1.94	49.4	UCF6-03	
UC-JCFX-0403	36400-0403	20318324	1/4	6.4	3/8-24	9/16	14	1/2	12	N/A	1.11	28.1	2.09	53.0	UCF6-04	
UC-JCFX-0404	36400-0404	20242786	1/4	6.4	7/16-20	5/8	16	9/16	14	N/A	1.17	29.6	2.15	54.5	UCF6-04	
UC-JCFX-0404S	36400-0404S	20540685	1/4	6.4	7/16-20	5/8	16	9/16	14	N/A	1.17	29.6	2.15	54.5	UCF6-04	
UC-JCFX-0405	36400-0405	20242746	1/4	6.4	1/2-20	11/16	17	9/16	14	N/A	1.24	31.4	2.22	56.3	UCF6-04	
UC-JCFX-0406	36400-0406	20242778	1/4	6.4	9/16-18	3/4	19	9/16	14	N/A	1.23	31.2	2.21	56.1	UCF6-04	
UC-JCFX-0504	36400-0504	20629768	5/16	7.9	7/16-20	5/8	16	9/16	14	N/A	1.20	30.4	2.18	55.3	UCF6-05	
UC-JCFX-0505	36400-0505	20242676	5/16	7.9	1/2-20	11/16	17	9/16	14	N/A	1.24	31.4	2.22	56.3	UCF6-05	
UC-JCFX-0506	36400-0506	20242765	5/16	7.9	9/16-18	3/4	19	9/16	14	N/A	1.23	31.2	2.21	56.1	UCF6-05	
UC-JCFX-0604	36400-0604	20688966	13/32	10.3	7/16-20					N/A					UCF6-06	
UC-JCFX-0606	36400-0606	20242787	13/32	10.3	9/16-18	3/4	19	11/16	17	N/A	1.22	31.1	2.27	57.7	UCF6-06	
UC-JCFX-0606S	36400-0606S	20540686	13/32	10.3	9/16-18	3/4	19	11/16	17	N/A	1.22	31.1	2.27	57.7	UCF6-06	
UC-JCFX-0608	36400-0608	20242779	13/32	10.3	3/4-16	1	25	3/4	19	N/A	1.37	34.9	2.42	61.5	UCF6-06	
UC-JCFX-0610	36400-0610	20242708	13/32	10.3	7/8-14	1 1/16	27	7/8	22	N/A	1.53	38.8	2.58	65.5	UCF6-06	

S: Stainless Steel

Continued on next page

# JIC 37° Flare (SAE J514)

Female | Swivel Continued

Descriptive #	Product #	SAP #	Hose Size ID		Thread Size (A)	Hex-1 Wrench Size		Hex-2 Wrench Size		Socket (S) Wrench Size	Cut-Off (C)		Length (L)		SR5, DR5, SCX5
			in.	mm		in.	mm	in.	mm	in.	in.	mm	in.	mm	
UC-JCFX-0806	36400-0806	20242666	1/2	12.7	9/16-18	3/4	19	3/4	19	N/A	1.29	32.8	2.54	64.5	UCF6-08
UC-JCFX-0808	36400-0808	20242785	1/2	12.7	3/4-16	1	25	3/4	19	N/A	1.44	36.7	2.69	68.4	UCF6-08
UC-JCFX-0808S	36400-0808S	20540687	1/2	12.7	3/4-16	1	25	3/4	19	N/A	1.44	36.7	2.69	68.4	UCF6-08
UC-JCFX-0810	36400-0810	20242772	1/2	12.7	7/8-14	1 1/16	27	7/8	22	N/A	1.56	39.6	2.81	71.3	UCF6-08
UC-JCFX-0812	36400-0812	20242727	1/2	12.7	1 1/16-12	1 1/4	32	1	25	N/A	1.68	42.6	2.93	74.3	UCF6-08
UC-JCFX-1008	36400-1008	20242399	5/8	15.9	3/4-16	1	25	15/16	24	N/A	1.52	38.7	2.88	73.2	UCF6-10
UC-JCFX-1010	36400-1010	20242774	5/8	15.9	7/8-14	1 1/16	27	15/16	24	N/A	1.67	42.4	3.03	76.9	UCF6-10
UC-JCFX-1010S	36400-1010S	20540688	5/8	15.9	7/8-14	1 1/16	27	15/16	24	N/A	1.67	42.4	3.03	76.9	UCF6-10
UC-JCFX-1012	36400-1012	20242580	5/8	15.9	1 1/16-12	1 1/4	32	1	25	N/A	1.68	42.6	3.04	77.1	UCF6-10
UC-JCFX-1416	36400-1416	20283395	7/8	22.2	1 5/16-12	1 1/2	38	1 1/4	32	N/A	1.85	47.0	3.40	86.3	UCF6-12
UC-JCFX-1816	36400-1816	20613766	1 1/8	28.6	1 5/16-12	1 1/2	38	1 3/8	41	N/A	1.80	45.8	3.56	90.4	UCF6-16
UC-JCFX-1820	36400-1820	20283399	1 1/8	28.6	1 5/8-12	2	50	1 3/8	41	N/A	2.09	53.0	3.84	97.6	UCF6-16
UC-JCFX-2224	36400-2224	20283397	1 3/8	34.9	1 7/8-12	2 3/16	55	2	50	N/A	2.46	62.4	4.50	114.4	UCF6-20
UC-JCFX-2932	36400-2932	20283398	1 13/16	46.0	2 1/2-12	2 3/4	70	2 9/16	65	N/A	2.86	72.7	5.70	144.8	UCF8-32

S: Stainless Steel

# JIC 37° Flare (SAE J514)

Female | 45° Elbow | Swivel

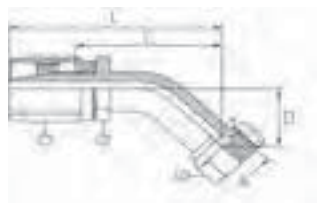

Descriptive #	Product #	SAP #	Hose Size ID		Thread Size (A)	Hex-1 Wrench Size	Hex-2 Wrench Size	Socket (S) Wrench Size	Drop (D)		Cut-Off (C)		Length (L)		SR5, DR5
			in.	mm		in.	in.	in.	in.	mm	in.	mm	in.	mm	
FG-JCFX45-0404	18420-0404	20245820	3/16	4.8	7/16-20	9/16	9/16	5/8	0.33	8.3	1.11	28.2	1.84	46.8	Y
FG-JCFX45-0505	18420-0505	20245821	1/4	6.4	1/2-20	9/16	5/8	11/16	0.36	9.1	1.28	32.5	1.06	27.0	Y
FG-JCFX45-0606	18420-0606	20245822	5/16	7.9	9/16-18	9/16	11/16	13/16	0.39	9.9	1.33	33.7	2.23	56.8	Y
FG-JCFX45-0808	18420-0808	20245823	13/32	10.3	3/4-16	11/16	7/8	15/16	0.55	13.9	1.84	46.8	2.98	75.8	Y
FG-JCFX45-1010	18420-1010	20245817	1/2	12.7	7/8-14	7/8	1	1 1/8	0.62	15.9	1.95	49.6	3.23	82.2	Y
FG-JCFX45-1212	18420-1212	20245818	5/8	15.9	1 1/16-12	1 1/8	1 1/4	1 1/2	0.77	19.5	2.22	56.4	3.78	96.0	Y
FG-JCFX45-1616	18420-1616	20245819	7/8	22.2	1 5/16-12	1 1/8	1 1/2	1 7/8	0.89	22.6	2.23	56.8	3.56	90.5	Y

Continued on next page

# JIC 37° Flare (SAE J514)

Female | 45° Elbow | Swivel Continued

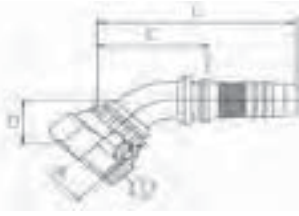

Descriptive #	Product #	SAP #	Hose Size ID		Thread Size (A)	Hex-1 Wrench Size		Socket (S) Wrench Size	Drop (D)		Cut-Off (C)		Length (L)		SR5, DR5, SCX5
			in.	mm		in.	mm		in.	mm	in.	mm	in.	mm	
UC-JCFX45-0304	36420-0304	20685771	1/4	6.4	7/16-20	5/8	16	N/A	0.39	10.0	1.44	36.6	2.31	58.8	UCF6-03
UC-JCFX45-0404	36420-0404	20242725	1/4	6.4	7/16-20	5/8	16	N/A	0.39	10.0	1.46	37.0	2.44	61.9	UCF6-04
UC-JCFX45-0405	36420-0405	20242628	1/4	6.4	1/2-20	11/16	17	N/A	0.47	12.0	1.46	37.0	2.44	61.9	UCF6-04
UC-JCFX45-0406	36420-0406	20242629	1/4	6.4	9/16-18	3/4	19	N/A	0.43	11.0	1.54	39.0	2.52	63.9	UCF6-04
UC-JCFX45-0506	36420-0506	20242489	5/16	7.9	9/16-18	3/4	19	N/A	0.47	11.9	1.69	42.9	2.67	67.8	UCF6-05
UC-JCFX45-0606	36420-0606	20242743	13/32	10.3	9/16-18	3/4	19	N/A	0.43	11.0	1.81	46.0	2.86	72.6	UCF6-06
UC-JCFX45-0608	36420-0608	20242698	13/32	10.3	3/4-16	1	25	N/A	0.59	15.0	1.85	47.0	2.90	73.6	UCF6-06
UC-JCFX45-0808	36420-0808	20242729	1/2	12.7	3/4-16	1	25	N/A	0.59	15.0	2.05	52.0	3.29	83.7	UCF6-08
UC-JCFX45-0810	36420-0810	20242675	1/2	12.7	7/8-14	1 1/16	27	N/A	0.63	16.0	2.01	51.0	3.26	82.7	UCF6-08
UC-JCFX45-1010	36420-1010	20242345	5/8	15.9	7/8-14	1 1/16	27	N/A	0.87	22.0	2.56	65.0	3.92	99.5	UCF6-10
UC-JCFX45-1012	36420-1012	20242344	5/8	15.9	1 1/16-12	1 1/4	32	N/A	0.83	21.0	2.72	69.0	4.07	103.5	UCF6-10
UC-JCFX45-1416	36420-1416	20749855	7/8	22.2	1 5/16-12	1 1/2	38	N/A	1.24	31.4	3.14	79.6	4.68	118.9	UCF6-12
UC-JCFX45-1820	36420-1820	20367919	1 1/8	28.6	1 1/2-12	2	50	N/A	1.52	38.6	3.43	87.1	5.19	131.7	UCF6-16

# JIC 37° Flare (SAE J514)

Female | 90° Elbow | Swivel

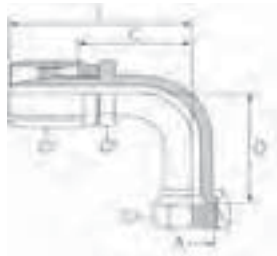

Elbow Type  
LT=Long Tube  
ST=Short Tube

Descriptive #	Product #	SAP #	Hose Size ID		Thread Size (A)	Hex-1 Wrench Size	Hex-2 Wrench Size	Socket (S) Wrench Size	Elbow Type	Drop (D)		Cut-Off (C)		Length (L)		SR5, DR5
			in.	mm						in.	mm	in.	mm	in.	mm	
FG-JCFX90-0404	18425-0404	20245827	3/16	4.8	7/16-20	9/16	9/16	5/8		0.69	17.5	1.00	25.4	1.75	44.5	Y
FG-JCFX90L-0404	18440-0404	20245834	3/16	4.8	7/16-20	9/16	9/16	5/8	LT	1.80	45.6	1.00	25.4	1.75	44.5	Y
FG-JCFX90-0505	18425-0505	20245828	1/4	6.4	1/2-20	9/16	5/8	11/16		0.77	19.5	1.19	30.2	1.97	50.0	Y
FG-JCFX90L-0505	18440-0505	20245835	1/4	6.4	1/2-20	9/16	5/8	11/16	LT	1.78	45.2	1.19	30.2	1.97	50.0	Y
FG-JCFX90-0606	18425-0606	20245829	5/16	7.9	9/16-18	11/16	11/16	13/16		0.84	21.4	1.23	31.4	2.12	54.0	Y
FG-JCFX90L-0606	18440-0606	20245836	5/16	7.9	9/16-18	11/16	11/16	13/16	LT	2.19	55.6	1.23	31.4	2.12	54.0	Y
FG-JCFX90-0808	18425-0808	20245830	13/32	10.3	3/4-16	7/8	7/8	15/16		1.09	27.8	1.61	40.9	2.75	69.9	Y
FG-JCFX90L-0808	18440-0808	20245837	13/32	10.3	3/4-16	7/8	7/8	15/16	LT	2.44	61.9	1.61	40.9	2.75	69.9	Y

Continued on next page

# JIC 37° Flare (SAE J514)

Female | 90° Elbow | Swivel Continued

Descriptive #	Product #	SAP #	Hose Size ID		Thread Size (A)	Hex-1	Hex-2	Socket (S)	Elbow Type	Drop (D)		Cut-Off (C)		Length (L)		SR5, DR5
			Wrench Size	Wrench Size		Wrench Size	in.	mm		in.	mm	in.	mm	in.	mm	
FG-JCFX90-1010	18425-1010	20245824	1/2	12.7	7/8-14	1 1/16	1	1 1/8		1.23	31.4	1.66	42.1	2.94	74.6	Y
FG-JCFX90L-1010	18440-1010	20245831	1/2	12.7	7/8-14	1 1/16	1	1 1/8	LT	2.56	65.1	1.66	42.1	2.94	74.6	Y
FG-JCFX90-1212	18425-1212	20245825	5/8	15.9	1 1/16-12	1 1/4	1 1/4	1 1/4		1.81	46.0	2.17	55.2	3.75	95.3	Y
FG-JCFX90L-1212	18440-1212	20245832	5/8	15.9	1 1/16-12	1 1/4	1 1/4	1 1/4	LT	3.73	94.9	2.17	55.2	3.75	95.3	Y
FG-JCFX90-1616	18425-1616	20245826	7/8	22.2	1 5/16-12	1 1/2	1 1/2	1 7/16		2.14	54.4	2.28	57.9	3.55	90.1	Y
FG-JCFX90L-1616	18440-1616	20245833	7/8	22.2	1 5/16-12	1 1/2	1 1/2	1 7/16	LT	4.33	109.9	2.28	57.9	3.55	90.1	Y

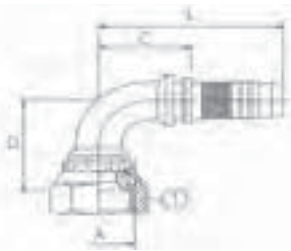

Elbow Type  
 LT=Long Tube  
 ST=Short Tube

Descriptive #	Product #	SAP #	Hose Size ID		Thread Size (A)	Hex-1	Hex-2	Socket (S)	Elbow Type	Drop (D)		Cut-Off (C)		Length (L)		SR5, DR5, SCX5
			Wrench Size	Wrench Size		Wrench Size	in.	mm		in.	mm	in.	mm	in.	mm	
UC-JCFX90-0304	36425-0304	20269250	3/16	4.8	7/16-20	5/8	16	N/A		1.26	32.0	1.30	33.0	2.17	55.2	UCF6-03
UC-JCFX90-0404	36425-0404	20242770	1/4	6.4	7/16-20	5/8	16	N/A		1.26	32.0	1.34	34.0	2.32	58.9	UCF6-04
UC-JCFX90L-0404	36440-0404	20242662	1/4	6.4	7/16-20	5/8	16	N/A	LT	1.81	46.0	1.25	31.8	2.23	56.7	UCF6-04
UC-JCFX90S-0404	36445-0404	20242430	1/4	6.4	7/16-20	5/8	16	N/A	ST	0.83	21.0	1.06	27.0	2.04	51.9	UCF6-04
UC-JCFX90-0405	36425-0405	20242657	1/4	6.4	1/2-20	11/16	17	N/A		1.18	30.0	1.02	26.0	2.00	50.9	UCF6-04
UC-JCFX90L-0405	36440-0405	20242473	1/4	6.4	1/2-20	11/16	17	N/A	LT	1.77	45.0	1.02	26.0	2.00	50.9	UCF6-04
UC-JCFX90S-0405	36445-0405	20242396	1/4	6.4	1/2-20	11/16	17	N/A	ST	0.93	23.5	1.02	26.0	2.00	50.9	UCF6-04
UC-JCFX90-0406	36425-0406	20242718	1/4	6.4	9/16-18	3/4	19	N/A		1.50	38.0	1.10	28.0	2.08	52.9	UCF6-04
UC-JCFX90L-0406	36440-0406	20242474	1/4	6.4	9/16-18	3/4	19	N/A	LT	2.13	54.0	1.34	34.0	2.32	58.9	UCF6-04
UC-JCFX90S-0406	36445-0406	20242397	1/4	6.4	9/16-18	3/4	19	N/A	ST	0.91	23.0	1.22	31.0	2.20	55.9	UCF6-04
UC-JCFX90-0504	36425-0504	20612476	5/16	7.9	7/16-20	5/8	16	N/A		1.26	32.0	1.34	34.0	2.32	58.9	UCF6-05
UC-JCFX90-0505	36425-0505	20242565	5/16	7.9	1/2-20	11/16	17	N/A		1.38	35.1	1.34	34.0	2.32	58.9	UCF6-05
UC-JCFX90-0506	36425-0506	20242490	5/16	7.9	9/16-18	3/4	19	N/A		1.38	35.1	1.30	33.0	2.28	57.9	UCF6-05
UC-JCFX90L-0506	36440-0506	20242454	5/16	7.9	9/16-18	3/4	19	N/A	LT	2.13	54.1	1.42	36.1	2.40	61.0	UCF6-05
UC-JCFX90-0604	36425-0604	20318323	13/32	10.3	7/16-20	5/8	16	N/A		1.26	32.0	1.38	35.0	2.43	61.6	UCF6-06
UC-JCFX90L-0604	36440-0604	20318322	13/32	10.3	7/16-20	5/8	16	N/A	LT	1.81	46.0	1.22	31.0	2.27	57.6	UCF6-06
UC-JCFX90-0606	36425-0606	20242776	13/32	10.3	9/16-18	3/4	19	N/A		1.38	35.0	1.22	31.0	2.27	57.6	UCF6-06
UC-JCFX90L-0606	36440-0606	20242720	13/32	10.3	9/16-18	3/4	19	N/A	LT	2.13	54.0	1.69	43.0	2.74	69.6	UCF6-06
UC-JCFX90S-0606	36445-0606	20242475	13/32	10.3	9/16-18	3/4	19	N/A	ST	0.91	23.0	1.65	42.0	2.70	68.7	UCF6-06
UC-JCFX90-0608	36425-0608	20242753	13/32	10.3	3/4-16	1	25	N/A		1.61	41.0	1.54	39.0	2.58	65.6	UCF6-06
UC-JCFX90L-0608	36440-0608	20242587	13/32	10.3	3/4-16	1	25	N/A	LT	2.52	64.0	1.85	47.0	2.90	73.6	UCF6-06
UC-JCFX90S-0608	36445-0608	20242431	13/32	10.3	3/4-16	1	25	N/A	ST	1.14	29.0	1.93	49.0	2.98	75.6	UCF6-06

Continued on next page



# JIC 37° Flare (SAE J514)

Female | 90° Elbow | Swivel Continued

Descriptive #	Product #	SAP #	Hose Size ID		Thread Size (A)	Hex-1 Wrench Size		Socket (S) Wrench Size	Elbow Type	Drop (D)		Cut-Off (C)		Length (L)		SR5, DR5, SCX5
			in.	mm		in.	mm			in.	mm	in.	mm	in.	mm	
UC-JCFX90-0808	36425-0808	20242764	1/2	12.7	3/4-16	1	25	N/A		1.58	40.0	1.46	37.0	2.70	68.7	UCF6-08
UC-JCFX90L-0808	36440-0808	20242688	1/2	12.7	3/4-16	1	25	N/A	LT	2.52	64.0	1.97	50.0	3.22	81.7	UCF6-08
UC-JCFX90S-0808	36445-0808	20242429	1/2	12.7	3/4-16	1	25	N/A	ST	1.14	29.0	1.81	46.0	3.06	77.7	UCF6-08
UC-JCFX90-0810	36425-0810	20242706	1/2	12.7	7/8-14	1 1/16	27	N/A		1.85	47.0	1.69	43.0	2.94	74.7	UCF6-08
UC-JCFX90L-0810	36440-0810	20242584	1/2	12.7	7/8-14	1 1/16	27	N/A	LT	2.56	65.0	1.46	37.0	2.70	68.7	UCF6-08
UC-JCFX90S-0810	36445-0810	20242395	1/2	12.7	7/8-14	1 1/16	27	N/A	ST	1.26	32.0	1.81	46.0	3.06	77.7	UCF6-08
UC-JCFX90-0812	36425-0812	20242349	1/2	12.7	1 1/16-12	1 1/4	32	N/A		1.81	46.0	1.46	37.0	2.70	68.7	UCF6-08
UC-JCFX90-1010	36425-1010	20242749	5/8	15.9	7/8-14	1 1/16	27	N/A		1.89	48.0	1.93	49.0	3.29	83.5	UCF6-10
UC-JCFX90L-1010	36440-1010	20242346	5/8	15.9	7/8-14	1 1/16	27	N/A	LT	2.56	65.0	1.97	50.0	3.32	84.4	UCF6-10
UC-JCFX90S-1010	36445-1010	20591962	5/8	15.9	7/8-14	1 1/16	27	N/A	ST							UCF6-10
UC-JCFX90-1012	36425-1012	20242350	5/8	15.9	1 1/16-12	1 1/4	32	N/A		2.28	58.0	1.89	48.0	3.25	82.5	UCF6-10
UC-JCFX90L-1012	36440-1012	20283400	5/8	15.9	1 1/16-12	1 1/4	32	N/A	LT							LU CF6-10
UC-JCFX90-1416	36425-1416	20749859	7/8	22.2	1 5/16-12	1 1/2	38	N/A		2.85	72.3	2.93	74.5	4.48	113.7	UCF6-12

# JIC 37° Flare (SAE J514)

Male

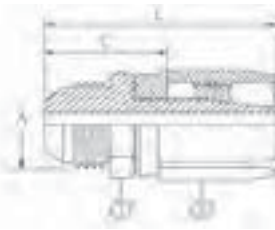

Descriptive #	Product #	SAP #	Hose Size ID		Thread Size (A)	Hex-1 Wrench Size	Socket (S) Wrench Size	Cut-Off (C)		Length (L)		SR5, DR5
			in.	mm				in.	mm	in.	mm	
FG-JCM-0404	18450-0404	20245775	3/16	4.8	7/16-20	1/2	5/8	1.09	27.8	1.84	46.8	Y
FG-JCM-0505	18450-0505	20245776	1/4	6.4	1/2-20	9/16	11/16	1.17	29.8	1.95	49.6	Y
FG-JCM-0606	18450-0606	20245777	5/16	7.9	9/16-18	5/8	13/16	1.22	31.0	2.12	54.0	Y
FG-JCM-0808	18450-0808	20245778	13/32	10.3	3/4-16	13/16	15/16	1.31	33.3	2.56	65.1	Y
FG-JCM-1010	18450-1010	20245770	1/2	12.7	7/8-14	15/16	1 1/8	1.50	38.1	2.89	73.4	Y
FG-JCM-1212	18450-1212	20245771	5/8	15.9	1 1/16-12	1 1/8	1 1/4	1.78	45.2	3.34	84.9	Y
FG-JCM-1616	18450-1616	20245772	7/8	22.2	1 5/16-12	1 3/8	1 7/16	1.69	42.9	2.94	74.6	Y
FG-JCM-2020	18450-2020	20245773	1 1/8	28.6	1 3/8-12	1 3/4	1 7/8	1.77	44.9	3.12	79.4	Y
FG-JCM-2424	18450-2424	20245774	1 3/8	35.0	1 7/8-12	2	2	1.97	50.0	3.42	86.9	Y

Continued on next page

## JIC 37° Flare (SAE J514)

Male | Continued

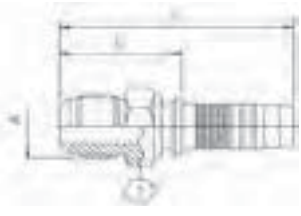

Descriptive #	Product #	SAP #	Hose Size ID		Thread Size (A)	Hex-1 Wrench Size		Socket (S) Wrench Size	Cut-Off (C)		Length (L)		SR5, DR5, SCX5
			in.	mm		in.	mm	in.	in.	mm	in.	mm	
UC-JCM-0304	36450-0304	20592795	3/16	4.8	7/16-20	1/2	12	N/A	0.98	24.8	1.85	47.0	UCF6-03
UC-JCM-0404	36450-0404	20242728	1/4	6.4	7/16-20	1/2	12	N/A	0.99	25.2	1.97	50.1	UCF6-04
UC-JCM-0405	36450-0405	20242664	1/4	6.4	1/2-20	9/16	14	N/A	1.03	26.2	2.01	51.1	UCF6-04
UC-JCM-0406	36450-0406	20242687	1/4	6.4	9/16-18	11/16	17	N/A	1.04	26.4	2.02	51.3	UCF6-04
UC-JCM-0505	36450-0505	20242588	5/16	7.9	1/2-20	9/16	14	N/A	1.04	26.3	2.02	51.2	UCF6-05
UC-JCM-0506	36450-0506	20242434	5/16	7.9	9/16-18	11/16	17	N/A	1.04	26.5	2.02	51.4	UCF6-05
UC-JCM-0606	36450-0606	20242759	13/32	10.3	9/16-18	11/16	17	N/A	1.05	26.6	2.10	53.2	UCF6-06
UC-JCM-0608	36450-0608	20242755	13/32	10.3	3/4-16	3/4	19	N/A	1.14	28.9	2.19	55.5	UCF6-06
UC-JCM-0610	36450-0610	20242630	13/32	10.3	7/8-14	15/16	24	N/A	1.33	33.8	2.38	60.5	UCF6-06
UC-JCM-0808	36450-0808	20242736	1/2	12.7	3/4-16	3/4	19	N/A	1.17	29.8	2.42	61.4	UCF6-08
UC-JCM-0810	36450-0810	20242716	1/2	12.7	7/8-14	15/16	24	N/A	1.35	34.4	2.60	66.0	UCF6-08
UC-JCM-0812	36450-0812	20242670	1/2	12.7	1 1/16-12	1 1/16	27	N/A	1.46	37.1	2.71	68.7	UCF6-08
UC-JCM-1010	36450-1010	20242435	5/8	15.9	7/8-14	15/16	24	N/A	1.38	35.0	2.73	69.4	UCF6-10
UC-JCM-1012	36450-1012	20242400	5/8	15.9	1 1/16-12	1 1/16	27	N/A	1.46	37.1	2.82	71.5	UCF6-10

## SAE 45° Flare (J512)

Female | Swivel

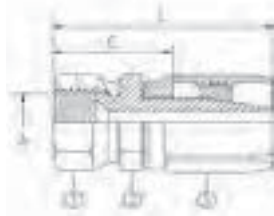

Descriptive #	Product #	SAP #	Hose Size ID		Thread Size (A)	Hex-1 Wrench Size	Hex-2 Wrench Size	Socket (S) Wrench Size	Cut-Off (C)		Length (L)		SR5, DR5
			in.	mm		in.	in.	in.	in.	mm	in.	mm	
FG-SFFX-0404	18775-0404	20245814	3/16	4.8	7/16-20	9/16	9/16	5/8	1.19	30.2	1.94	49.2	Y
FG-SFFX-0505	18775-0505	20245815	1/4	6.4	1/2-20	5/8	5/8	11/16	1.30	32.9	2.08	52.8	Y
FG-SFFX-0606	18775-0606	20245816	5/16	7.9	5/8-18	3/4	3/4	13/16	1.44	36.5	2.34	59.5	Y
FG-SFFX-0808	18775-0808	20291192	13/32	10.3	3/4-16	7/8	7/8	7/8	1.60	40.6	2.70	68.6	Y
FG-SFFX-1010	18775-1010	20245812	1/2	12.7	7/8-14	1	1	1 1/8	1.67	42.5	3.06	77.8	Y
FG-SFFX-1212	18775-1212	20245813	5/8	15.9	1 1/16-14	1 1/4	1 1/4	1 1/4	1.92	48.8	3.50	88.9	Y

Continued on next page

## SAE 45° Flare (J512)

Female | Swivel Continued

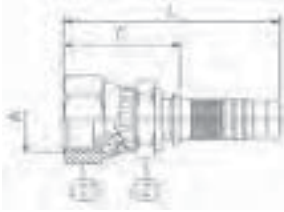

Descriptive #	Product #	SAP #	Hose Size ID		Thread Size (A)	Hex-1 Wrench Size		Hex-2 Wrench Size		Socket (S) Wrench Size	Cut-Off (C)		Length (L)		SR5, DR5, SCX5
			in.	mm	in.	mm	in.	mm	in.	mm	in.	mm	in.	mm	
UC-SFFX-0304	36775-0304	20778888	3/16	4.8	7/16-20	5/8	16	9/16	13	N/A	1.07	27.2	1.94	49.4	UCF6-03
UC-SFFX-0506	36775-0506	20778889	5/16	7.9	5/8-18	7/8	22			N/A	1.32	33.5	2.30	58.4	UCF6-05
UC-SFFX-0606	36775-0606	20242760	13/32	10.3	5/8-18	7/8	22	7/8	19	N/A	1.32	33.6	2.37	60.2	UCF6-06
UC-SFFX-0608	36775-0608	20318359	13/32	10.3	3/4-16	1	25	13/16	19	N/A	1.37	34.9	2.42	61.5	UCF6-06
UC-SFFX-0808	36775-0808	20778907	1/2	12.7	3/4-16	1	25	3/4	19	N/A	1.44	36.7	2.69	68.4	UCF6-08
UC-SFFX-0810	36775-0810	20778908	1/2	12.7	7/8-14	1 1/16	27	7/8	22	N/A	1.6	40.6	2.85	72.3	UCF6-08

## SAE 45° Flare (J512)

Female | 45° Elbow | Swivel

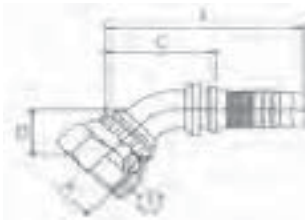

Descriptive #	Product #	SAP #	Hose Size ID		Thread Size (A)	Hex-1 Wrench Size		Drop (D)		Cut-Off (C)		Length (L)		GS5, DR5, SCX5
			in.	mm	in.	mm	in.	mm	in.	mm	in.	mm		
UC-SFFX45-0506	36777-0506	20778900	5/16	7.9	5/8-18	7/8	22	0.47	11.9	1.69	42.9	2.67	67.8	UCF6-05
UC-SFFX45-0606	36777-0606	20318360	13/32	10.3	5/8-18	7/8	22	0.47	12.0	1.811	46.0	2.86	72.6	UCF6-06
UC-SFFX45-0608	36777-0608	20778909	13/32	10.3	3/4-16	1	25	0.59	15.0	1.85	47.0	2.9	73.6	UCF6-06
UC-SFFX45-0808	36777-0808	20318361	1/2	12.7	3/4-16	1	25	0.59	15.0	2.05	52.0	3.29	83.7	UCF6-08
UC-SFFX45-0810	36777-0810	20778901	1/2	12.7	7/8-14	1 1/16	27	0.63	16.0	2.01	51.0	3.26	82.7	UCF6-08

## SAE 45° Flare (J512)

Female | 90° Elbow | Swivel

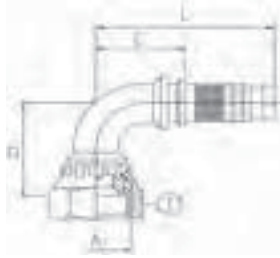

Descriptive #	Product #	SAP #	Hose Size ID		Thread Size (A)		Hex-1 Wrench Size		Drop (D)		Cut-Off (C)		Length (L)		GS5, DR5, SCX5
			in.	mm	in.	mm	in.	mm	in.	mm	in.	mm	in.	mm	
UC-SFFX90-0506	36780-0506	20778902	5/16	7.9	5/8-18	7/8	22	1.38	35	1.30	33.0	2.28	57.9	UCF6-05	
UC-SFFX90-0606	36780-0606	20318325	13/32	10.3	5/8-18	7/8	22	0.95	24	1.65	42.0	2.70	68.7	UCF6-06	
UC-SFFX90L-0606	36781-0606	20318362	13/32	10.3	5/8-18	7/8	22	2.19	55	1.69	43.0	2.74	69.6	UCF6-06	
UC-SFFX90-0608	36780-0608	20761705	13/32	10.3	3/4-16	1	25	1.61	41	1.54	39.0	2.58	65.6	UCF6-06	
UC-SFFX90S-0608	36783-0608	20778910	13/32	10.3	3/4-16	1	25	1.14	29	1.93	49.0	2.98	75.6	UCF6-06	
UC-SFFX90-0808	36780-0808	20778903	1/2	12.7	3/4-16	1	25	1.58	40	1.46	37.0	2.70	68.7	UCF6-08	
UC-SFFX90S-0808	36783-0808	20318363	1/2	12.7	3/4-16	1	25	1.14	29	1.81	46.0	3.06	77.7	UCF6-08	
UC-SFFX90-0810	36780-0810	20778904	1/2	12.7	7/8-14	1 1/16	27	2.13	54	2.05	52.0	3.60	91.4	UCF6-08	
UC-SFFX90S-0810	36783-0810	20778905	1/2	12.7	7/8-14	1 1/16	27	1.26	32	1.81	46.0	3.06	77.7	UCF6-08	

## SAE 45° Flare (J512)

Male

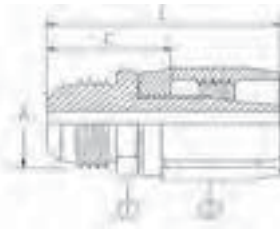

Descriptive #	Product #	SAP #	Hose Size ID		Thread Size (A)		Hex-1 Wrench Size		Socket (S) Wrench Size		Cut-Off (C)		Length (L)		SR5, DR5
			in.	mm	in.	mm	in.	mm	in.	mm	in.	mm			
FG-SFM-0404	18785-0404	20245626	3/16	4.8	7/16-20	1/2	5/8	1.03	26.2	1.80	45.6	Y			
FG-SFM-0505	18785-0505	20245627	1/4	6.4	1/2-20	9/16	11/16	1.19	30.2	1.97	50.0	Y			
FG-SFM-0606	18785-0606	20245628	5/16	7.9	5/8-18	11/16	13/16	1.28	32.5	2.19	55.6	Y			
FG-SFM-0808	18785-0808	20245629	13/32	10.3	3/4-16	13/16	15/16	1.41	35.7	2.66	67.5	Y			
FG-SFM-1010	18785-1010	20245624	1/2	12.7	7/8-14	15/16	1 1/8	1.59	40.5	3.00	76.2	Y			
FG-SFM-1212	18785-1212	20245625	5/8	15.9	1 1/16-14	1 1/8	1 1/4	1.81	46.0	3.50	88.9	Y			

Continued on next page

# SAE 45° Flare (J512)

Female | Swivel Continued



Descriptive #	Product #	SAP #	Hose Size ID		Thread Size (A)	Hex-1 Wrench Size	Socket (S) Wrench Size	Cut-Off (C)		Length (L)		SR5, DR5, SCX5
			in.	mm		in.	in.	in.	mm	in.	mm	
UC-SFM-0606	36785-0606	20318320	13/32	10.0	5/8-18	5/8	16	1.12	28.5	2.17	55.2	UCF6-06
UC-SFM-0608	36785-0608	20778911	13/32	10.0	3/4-16	3/4	19	1.23	31.2	2.28	57.9	UCF6-06
UC-SFM-0808	36785-0808	20778906	1/2	12.7	3/4-16	3/4	19	1.27	32.1	2.51	63.8	UCF6-08

# SAE 45° Inverted Flare

Male | Swivel



Descriptive #	Product #	SAP #	Hose Size ID		Thread Size (A)	Hex-1 Wrench Size	Socket (S) Wrench Size	Cut-Off (C)		Length (L)		SR5, DR5
			in.	mm		in.	in.	in.	mm	in.	mm	
FG-SIMX-0404	18800-0404	20245779	3/16	4.8	7/16-24	3/8	5/8	1.72	43.7	2.47	62.7	Y
FG-SIMX-0505	18800-0505	20245780	1/4	6.4	1/2-20	7/16	11/16	1.84	46.8	2.62	66.7	Y
FG-SIMX-0606	18800-0606	20245781	5/16	7.9	5/8-18	1/2	13/16	1.81	46.0	2.72	69.1	Y
FG-SIMX-0808	18800-0808	20245782	13/32	10.3	3/4-18	5/8	15/16	1.98	50.4	3.12	79.4	Y



Descriptive #	Product #	SAP #	Hose Size ID		Thread Size (A)	Hex-1 Wrench Size	Cut-Off (C)		Length (L)		SR5, DR5, SCX5	
			in.	mm		in.	mm	in.	mm	in.		mm
UC-SIMX-0403	36800-0403	20318328	1/4	6.4	3/8-24	1/2	12	1.68	42.7	2.66	67.6	UCF6-04
UC-SIMX-0404	36800-0404	20318329	1/4	6.4	7/16-24	1/2	12	1.70	43.1	2.68	67.9	UCF6-04
UC-SIMX-0405	36800-0405	20318330	1/4	6.4	1/2-20	9/16	14	1.83	46.6	2.81	71.5	UCF6-04
UC-SIMX-0605	36800-0605	20318331	13/32	10.3	1/2-20	9/16	14	1.84	46.8	2.89	73.4	UCF6-06
UC-SIMX-0606	36800-0606	20318332	13/32	10.3	5/8-18	11/16	17	1.89	48.0	2.94	74.7	UCF6-06
UC-SIMX-0607	36800-0607	20318333	13/32	10.3	11/16-18	3/4	19	1.92	48.7	2.97	75.3	UCF6-06
UC-SIMX-0808	36800-0808	20318334	1/2	12.7	3/4-18	3/4	19	2.00	50.8	3.25	82.5	UCF6-08
UC-SIMX-0810	36800-0810	20318335	1/2	12.7	7/8-18	15/16	24	2.07	52.7	3.32	84.4	UCF6-08

# SAE 45° Inverted Flare

Male | 45° Elbow | Swivel

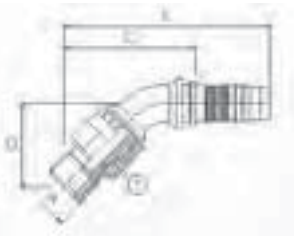

Descriptive #	Product #	SAP #	Hose Size ID		Thread Size (A)	Hex-1 Wrench Size		Drop (D)		Cut-Off (C)		Length (L)		GS5, DR5, SCX5
			in.	mm		in.	mm	in.	mm	in.	mm	in.	mm	
UC-SIMX45-0403	36810-0403	20318336	1/4	6.4	3/8-24	1/2	12	1.24	31.5	2.68	68.1	3.66	93.0	UCF6-04
UC-SIMX45-0404	36810-0404	20318337	1/4	6.4	7/16-24	1/2	12	1.24	31.5	2.68	68.1	3.66	93.0	UCF6-04
UC-SIMX45-0604	36810-0604	20318338	13/32	10.3	7/16-24	1/2	12	1.57	39.9	2.95	74.9	4.00	101.6	UCF6-06
UC-SIMX45-0605	36810-0605	20318339	13/32	10.3	1/2-20	9/16	14	1.50	38.1	2.99	75.9	4.04	102.6	UCF6-06
UC-SIMX45-0606	36810-0606	20318340	13/32	10.3	5/8-18	11/16	17	1.50	38.1	2.99	75.9	4.04	102.6	UCF6-06
UC-SIMX45-0607	36810-0607	20318341	13/32	10.3	11/16-18	3/4	19	1.50	38.1	2.99	75.9	4.04	102.6	UCF6-06

# SAE 45° Inverted Flare

Male | 90° Elbow | Swivel

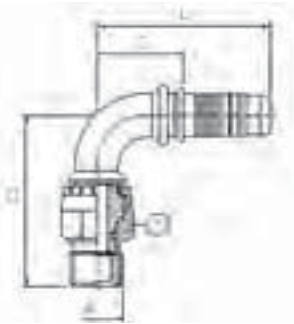

Descriptive #	Product #	SAP #	Hose Size ID		Thread Size (A)	Hex-1 Wrench Size		Drop (D)		Cut-Off (C)		Length (L)		GS5, DR5, SCX5
			in.	mm		in.	mm	in.	mm	in.	mm	in.	mm	
UC-SIMX90-0404	36815-0404	20318343	1/4	6.4	7/16-24	1/2	12	2.05	52.1	1.30	33.0	2.28	57.9	UCF6-04
UC-SIMX90-0405	36815-0405	20318344	1/4	6.4	1/2-20	9/16	14	1.96	49.8	1.52	38.6	2.50	63.5	UCF6-04
UC-SIMX90-0604	36815-0604	20318345	13/32	10.3	7/16-24	1/2	12	2.44	62.0	1.34	34.0	2.39	60.7	UCF6-06
UC-SIMX90-0605	36815-0605	20318346	13/32	10.3	1/2-20	9/16	14	2.44	62.0	1.38	35.1	2.43	61.7	UCF6-06
UC-SIMX90-0606	36815-0606	20318347	13/32	10.3	5/8-18	11/16	17	2.44	62.0	1.38	35.1	2.43	61.7	UCF6-06
UC-SIMX90-0607	36815-0607	20318348	13/32	10.3	11/16-18	3/4	19	2.44	62.0	1.38	35.1	2.43	61.7	UCF6-06
UC-SIMX90-0808	36815-0808	20318349	1/2	12.7	3/4-18	3/4	19	2.32	58.9	2.13	54.1	3.35	85.8	UCF6-08

# NPTF

Female



Descriptive #	Product #	SAP #	Hose Size ID		Thread Size (A)	Hex-1 Wrench Size		Cut-Off (C)		Length (L)		GS5, DR5, SCX5
			in.	mm		in.	mm	in.	mm	in.	mm	
UC-NPF-0402	36600-0402	20638492	1/4	6.4	1/8-27	9/16	14	0.88	22.4	1.86	47.3	UCF6-04
UC-NPF-0404	36600-0404	20242660	1/4	6.4	1/4-18	3/4	19	1.09	27.6	2.07	52.5	UCF6-04
UC-NPF-0606	36600-0606	20242656	13/32	10.3	3/8-18	7/8	22	1.15	29.2	2.20	55.8	UCF6-06
UC-NPF-0808	36600-0808	20242622	1/2	12.7	1/2-14	1	25	1.40	35.6	2.65	67.2	UCF6-08

# NPTF

Male

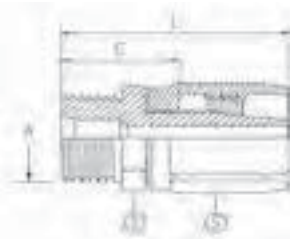

Descriptive #	Product #	SAP #	Hose Size ID		Thread Size (A)	Hex-1 Wrench Size	Socket (S) Wrench Size		Cut-Off (C)		Length (L)		SR5, DR5
			in.	mm			in.	mm	in.	mm	in.	mm	
FG-NPM-0402	18615-0402	20245804	3/16	4.8	1/8-27	9/16	5/8	0.92	23.4	1.67	42.5	Y	
FG-NPM-0404	18615-0404	20245805	3/16	4.8	1/4-18	9/16	5/8	1.11	28.2	1.86	47.2	Y	
FG-NPM-0504	18615-0504	20245806	1/4	6.4	1/4-18	9/16	11/16	1.19	30.2	1.97	50.0	Y	
FG-NPM-0604	18615-0604	20245807	5/16	7.9	1/4-18	9/16	13/16	1.23	31.4	2.17	55.2	Y	
FG-NPM-0606	18615-0606	20245808	5/16	7.9	3/8-18	11/16	13/16	1.27	32.2	2.20	56.0	Y	
FG-NPM-0806	18615-0806	20245809	13/32	10.3	3/8-18	11/16	15/16	1.33	33.7	2.48	63.1	Y	
FG-NPM-0808	18615-0808	20245811	13/32	10.3	1/2-14	7/8	15/16	1.56	39.7	2.72	69.1	Y	
FG-NPM-1008	18615-1008	20245810	1/2	12.7	1/2-14	7/8	1 1/8	1.59	40.5	2.86	72.6	Y	
FG-NPM-1012	18615-1012	20245802	1/2	12.7	3/4-14	1 1/16	1 1/8	1.66	42.1	2.91	73.8	Y	
FG-NPM-1212	18615-1212	20245803	5/8	15.9	3/4-14	1 1/16	1 1/4	1.67	42.5	3.20	81.4	Y	
FG-NPM-1612	18615-1612	20245842	7/8	22.2	3/4-14	1 3/8	1 7/16	1.53	38.9	2.80	71.0	Y	
FG-NPM-1616	18615-1616	20245841	7/8	22.2	1-11 1/2	1 3/8	1 7/16	1.72	43.7	2.98	75.8	Y	
FG-NPM-2020	18615-2020	20245838	1 1/8	28.6	1 1/4-11 1/2	1 3/4	1 3/4	1.83	46.4	3.19	81.0	Y	
FG-NPM-2424	18615-2424	20245840	1 3/8	34.9	1 1/2-11 1/2	2	2	1.92	48.8	3.36	85.3	Y	
FG-NPM-3232	18615-3232	20245839	1 3/4	46.0	2-11 1/2	2 1/2	2 1/2	2.06	52.4	3.91	99.2	Y	

Continued on next page

# NPTF

## Male Continued

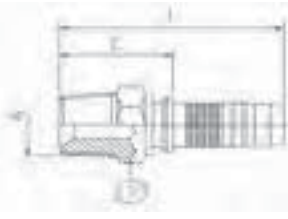

Descriptive #	Product #	SAP #	Hose Size ID		Thread Size (A)	Hex-1 Wrench Size		Cut-Off (C)		Length (L)		SR5, DR5, SCX5
			in.	mm		in.	mm	in.	mm	in.	mm	
UC-NPM-0302	36615-0302	20242703	3/16	4.8	1/8-27	1/2	12	0.78	19.7	1.65	41.9	UCF6-03
UC-NPM-0402	36615-0402	20242766	1/4	6.4	1/8-27	9/16	14	0.84	21.2	1.82	46.1	UCF6-04
UC-NPM-0404	36615-0404	20242780	1/4	6.4	1/4-18	11/16	17	1.06	27.0	2.04	51.9	UCF6-04
UC-NPM-0404S	36615-0404S	20540691	1/4	6.4	1/4-18	11/16	17	1.06	27.0	2.04	51.9	UCF6-04
UC-NPM-0406	36615-0406	20242748	1/4	6.4	3/8-18	3/4	19	1.09	27.7	2.07	52.6	UCF6-04
UC-NPM-0408	36615-0408	20242661	1/4	6.4	1/2-14	7/8	22	1.27	32.2	2.25	57.1	UCF6-04
UC-NPM-0504	36615-0504	20283392	5/16	7.9	1/4-18	11/16	17	1.07	27.1	2.05	52.0	UCF6-05
UC-NPM-0504S	36615-0504S	20540692	5/16	7.9	1/4-18	11/16	17	1.07	27.1	2.05	52.0	UCF6-05
UC-NPM-0506	36615-0506	20283396	5/16	7.9	3/8-18	3/4	19	1.10	27.9	2.08	52.8	UCF6-05
UC-NPM-0508	36615-0508	20592578	5/16	7.9	1/2-14			1.27	32.3	2.25	57.2	UCF6-05
UC-NPM-0604	36615-0604	20242761	13/32	10.3	1/4-18	11/16	17	1.07	27.2	2.12	53.8	UCF6-06
UC-NPM-0606	36615-0606	20242782	13/32	10.3	3/8-18	3/4	19	1.10	27.9	2.15	54.6	UCF6-06
UC-NPM-0606S	36615-0606S	20540693	13/32	10.3	3/8-18	3/4	19	1.10	27.9	2.15	54.6	UCF6-06
UC-NPM-0608	36615-0608	20242767	13/32	10.3	1/2-14	7/8	22	1.27	32.4	2.32	59.0	UCF6-06
UC-NPM-0806	36615-0806	20242722	1/2	12.7	3/8-18	3/4	19	1.12	28.4	2.37	60.1	UCF6-08
UC-NPM-0808	36615-0808	20242775	1/2	12.7	1/2-14	7/8	22	1.30	33.0	2.55	64.7	UCF6-08
UC-NPM-0808S	36615-0808S	20540694	1/2	12.7	1/2-14	7/8	22	1.30	33.0	2.55	64.7	UCF6-08
UC-NPM-0812	36615-0812	20242679	1/2	12.7	3/4-14	1 1/16	27	1.34	34.1	2.59	65.8	UCF6-08
UC-NPM-1012	36615-1012	20274105	5/8	15.9	3/4-14	1 1/16	27	1.35	34.4	2.71	68.9	UCF6-10
UC-NPM-1416	36615-1416	20269531	7/8	22.2	1-11 1/2	1 7/16	36	1.73	43.9	3.27	83.1	UCF6-12
UC-NPM-1820	36615-1820	20283394	1 1/8	28.6	1 1/4-11 1/2	1 13/16	46	1.89	48.0	3.65	92.6	UCF6-16
UC-NPM-2224	36615-2224	20283393	1 3/8	34.9	1 1/2-11 1/2	2	50	1.99	50.6	4.04	102.6	UCF6-20
UC-NPM-2932	36615-2932	20269535	1 3/16	46.0	2-11 1/2	2 9/16	65	2.14	54.4	4.98	126.5	UCF8-32

S: Stainless Steel



# NPTF

Male | Swivel



Descriptive #	Product #	SAP #	Hose Size ID		Thread Size (A)	Hex-1 Wrench Size		Cut-Off (C)		Length (L)		GS5, DR5, SCX5
			in.	mm		in.	mm	in.	mm	in.	mm	
UC-NPMX-0404	36645-0404	20242757	1/4	6.4	1/4-18	11/16	17	1.49	37.8	2.47	62.7	UCF6-04
UC-NPMX-0406	36645-0406	20242519	1/4	6.4	3/8-18	7/8	22	1.57	39.9	2.55	64.8	UCF6-04
UC-NPMX-0604	36645-0604	20242745	13/32	10.3	1/4-18	11/16	17	1.58	40.1	2.63	66.8	UCF6-06
UC-NPMX-0606	36645-0606	20242777	13/32	10.3	3/8-18	7/8	22	1.49	37.8	2.54	64.4	UCF6-06
UC-NPMX-0608	36645-0608	20242751	13/32	10.3	1/2-14	1	25	1.71	43.5	2.76	70.2	UCF6-06
UC-NPMX-0806	36645-0806	20242503	1/2	12.7	3/8-18	7/8	22	1.51	38.5	2.76	70.1	UCF6-08
UC-NPMX-0808	36645-0808	20242762	1/2	12.7	1/2-14	1	25	1.66	42.3	2.91	73.9	UCF6-08

# NPTF

Male | 90° Elbow (Block) | Swivel

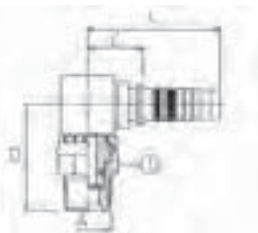

Descriptive #	Product #	SAP #	Hose Size ID		Thread Size (A)	Hex-1 Wrench Size		Drop (D)		Cut-Off (C)		Length (L)		GS5, DR5, SCX5
			in.	mm		in.	mm	in.	mm	in.	mm			
UC-NPMX90B-0404	36650-0404	20318350	1/4	6.4	1/4-18	11/16	17	1.69	42.9	0.71	18.1	1.69	43.0	UCF6-04
UC-NPMX90B-0604	36650-0604	20318351	13/32	10.3	1/4-18	11/16	17	1.63	41.5	0.92	23.3	1.97	50.0	UCF6-06
UC-NPMX90B-0606	36650-0606	20318352	13/32	10.3	3/8-18	7/8	22	1.62	41.2	0.92	23.3	1.97	50.0	UCF6-06
UC-NPMX90B-0808	36650-0808	20318353	1/2	12.7	1/2-14	1	25	2.15	54.6	1.16	29.4	2.41	61.1	UCF6-08

## NPSM

Female | Swivel

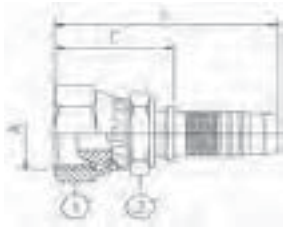

Descriptive #	Product #	SAP #	Hose Size ID		Thread Size (A)	Hex-1 Wrench Size		Hex-2 Wrench Size		Cut-Off (C)		Length (L)		GS5, DR5, SCX5
			in.	mm		in.	mm	in.	mm	in.	mm	in.	mm	
UC-NSFX-0404	36655-0404	20242668	1/4	6.4	1/4-18	3/4	19	11/16	17	1.19	30.2	2.17	55.1	UCF6-04
UC-NSFX-0606	36655-0606	20242669	13/32	10.3	3/8-18	7/8	22	3/4	19	1.24	31.4	2.29	58.0	UCF6-06
UC-NSFX-0808	36655-0808	20242654	1/2	12.7	1/2-14	1 1/16	27	7/8	22	1.35	34.3	2.60	66.0	UCF6-08

## SAE J514 Flareless Tube Fittings

Male



Descriptive #	Product #	SAP #	Hose Size ID		Thread Size (A)	Hex-1 Wrench Size		Cut-Off (C)		Length (L)		GS5, DR5, SCX5
			in.	mm		in.	mm	in.	mm	in.	mm	
UC-FTM-0404	36360-0404	20286107	1/4	6.4	7/16-20	1/2	12	0.88	22.2	1.86	47.1	UCF6-04
UC-FTM-0506	36360-0506	20295568	5/16	7.9	9/16-18	5/8	16	0.97	24.7	1.95	49.6	UCF6-05
UC-FTM-0606	36360-0606	20286108	13/32	10.3	9/16-18	5/8	16	0.97	24.7	2.02	51.4	UCF6-06

\*All fittings come with Nut and Sleeve

## Standpipe



Descriptive #	Product #	SAP #	Hose Size ID		Tube OD (A)	Cut-Off (C)		Length (L)		GS5, DR5, SCX5
			in.	mm	mm	in.	mm	in.	mm	
UC-SP-0408	36825-0408	20242506	1/4	6.4	8	1.19	30.3	2.17	55.2	UCF6-04
UC-SP-0410	36825-0410	20242461	1/4	6.4	10	1.27	32.3	2.25	57.2	UCF6-04
UC-SP-0610	36825-0610	20242555	13/32	10.3	10	1.19	30.2	2.24	56.9	UCF6-06
UC-SP-0612	36825-0612	20242576	13/32	10.3	12	1.15	29.2	2.20	55.9	UCF6-06
UC-SP-0815	36825-0815	20242372	1/2	12.7	15	1.26	32.0	2.51	63.7	UCF6-08
UC-SP-0816	36825-0816	20242482	1/2	12.7	16	1.46	37.1	2.71	68.8	UCF6-08

# Standpipe

45° Elbow

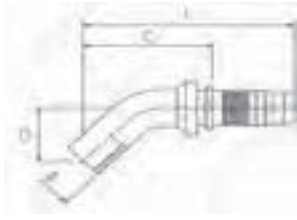

Descriptive #	Product #	SAP #	Hose Size ID		Tube OD (A)	Drop (D)		Cut-Off (C)		Length (L)		GS5, DR5, SCX5
			in.	mm	mm	in.	mm	in.	mm	in.	mm	
UC-SP45-0408	36830-0408	20242370	1/4	6.4	8	0.91	23.1	1.69	42.9	2.67	67.8	UCF6-04

# O-Ring Face Seal (SAE J1453 ORS/ORFS)

Female | Swivel



Descriptive #	Product #	SAP #	Hose Size ID		Thread Size (A)	Hex-1 Wrench Size		Hex-2 Wrench Size		Cut-Off (C)		Length (L)		SR5, DR5, SCX5
			in.	mm	in.	mm	in.	mm	in.	mm	in.	mm		
UC-OFFX-0404	36700-0404	20242723	1/4	6.4	9/16-18	11/16	17	9/16	14	1.07	27.3	2.05	52.2	UCF6-04
UC-OFFX-0406	36700-0406	20242655	1/4	6.4	11/16-16	7/8	22	11/16	17	1.19	30.1	2.17	55.0	UCF6-04
UC-OFFX-0408	36700-0408	20242441	1/4	6.4	13/16-16	15/16	24	7/8	22	1.39	35.4	2.37	60.3	UCF6-04
UC-OFFX-0506	36700-0506	20242544	5/16	7.9	11/16-16	7/8	22	11/16	17	1.19	30.2	2.17	55.1	UCF6-05
UC-OFFX-0604	36700-0604	20612477	13/32	10.3	9/16-18	11/16	17	11/16	17	1.12	28.4	2.17	55.1	UCF6-06
UC-OFFX-0606	36700-0606	20242763	13/32	10.3	11/16-16	7/8	22	11/16	17	1.19	30.3	2.24	56.9	UCF6-06
UC-OFFX-0608	36700-0608	20242691	13/32	10.3	13/16-16	15/16	24	7/8	22	1.40	35.6	2.45	62.2	UCF6-06
UC-OFFX-0806	36700-0806	20242552	1/2	12.7	11/16-16	7/8	22	3/4	19	1.26	32.0	2.51	63.7	UCF6-08
UC-OFFX-0808	36700-0808	20242733	1/2	12.7	13/16-16	15/16	24	7/8	22	1.42	36.1	2.67	67.8	UCF6-08
UC-OFFX-0810	36700-0810	20242704	1/2	12.7	1-14	13/16	30	15/16	24	1.56	39.5	2.80	71.2	UCF6-08
UC-OFFX-0812	36700-0812	20242551	1/2	12.7	13/16-12	17/16	36	13/16	30	1.66	42.1	2.90	73.8	UCF6-08
UC-OFFX-1010	36700-1010	20242442	5/8	15.9	1-14	13/16	30	15/16	24	1.56	39.6	2.92	74.1	UCF6-10
UC-OFFX-1012	36700-1012	20242367	5/8	15.9	13/16-12	17/16	36	13/16	30	1.66	42.1	3.10	78.8	UCF6-10

# O-Ring Face Seal (SAE J1453 ORS/ORFS)

Female | 45° Elbow | Swivel

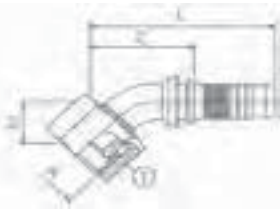

Descriptive #	Product #	SAP #	Hose Size ID		Thread Size (A)		Hex-1 Wrench Size		Drop (D)		Cut-Off (C)		Length (L)		SR5, DR5, SCX5
			in.	mm	in.	mm	in.	mm	in.	mm	in.	mm			
UC-OFFX45-0404	36710-0404	20242631	1/4	6.4	9/16-18	11/16	17	0.43	10.9	1.61	41.0	2.59	65.9	UCF6-04	
UC-OFFX45-0406	36710-0406	20242549	1/4	6.4	11/16-16	7/8	22	0.43	10.9	1.81	46.0	2.79	70.9	UCF6-04	
UC-OFFX45-0506	36710-0506	20242456	5/16	7.9	11/16-16	7/8	22	0.47	11.9	1.81	46.0	2.79	70.9	UCF6-05	
UC-OFFX45-0606	36710-0606	20242683	13/32	10.3	11/16-16	7/8	22	0.47	11.9	1.85	47.0	2.90	73.6	UCF6-06	
UC-OFFX45-0608	36710-0608	20242593	13/32	10.3	13/16-16	15/16	24	0.59	15.0	2.01	51.0	3.06	77.6	UCF6-06	
UC-OFFX45-0808C	36710-0808	20242637	1/2	12.7	13/16-16	15/16	24	0.63	16.0	1.85	47.0	3.10	78.7	UCF6-08	
UC-OFFX45-0810	36710-0810	20242532	1/2	12.7	1-14	1 3/16	30	0.65	16.5	1.97	50.0	3.22	81.7	UCF6-08	

C: Crimp Nut (see "Fitting Identification" in Appendix for details)

# O-Ring Face Seal (SAE J1453 ORS/ORFS)

Female | 90° Elbow | Swivel

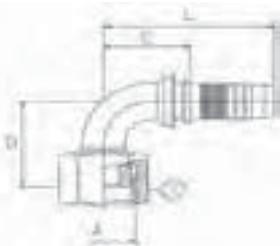

Elbow Type  
LT=Long Tube  
ST=Short Tube

Descriptive #	Product #	SAP #	Hose Size ID		Thread Size (A)		Hex-1 Wrench Size	Elbow Type	Drop (D)		Cut-Off (C)		Length (L)		SR5, DR5, SCX5
			in.	mm	in.	mm			in.	mm	in.	mm	in.	mm	
UC-OFFX90-0404	36715-0404	20242602	1/4	6.4	9/16-18	11/16	17		1.26	32.0	1.18	30.0	2.16	54.9	UCF6-04
UC-OFFX90L-0404	36720-0404	20242533	1/4	6.4	9/16-18	11/16	17	LT	1.81	46.0	1.30	33.0	2.28	57.9	UCF6-04
UC-OFFX90S-0404	36725-0404	20242682	1/4	6.4	9/16-18	11/16	17	ST	0.83	21.0	1.10	28.0	2.08	52.9	UCF6-04
UC-OFFX90-0406	36715-0406	20242479	1/4	6.4	11/16-16	7/8	22		1.50	38.0	1.46	37.0	2.44	61.9	UCF6-04
UC-OFFX90L-0406	36720-0406	20242492	1/4	6.4	11/16-16	7/8	22	LT	2.13	54.0	1.38	35.0	2.36	59.9	UCF6-04
UC-OFFX90S-0406	36725-0406	20242598	1/4	6.4	11/16-16	7/8	22	ST	0.91	23.0	1.26	32.0	2.24	56.9	UCF6-04
UC-OFFX90S-0506	36725-0506	20242494	5/16	7.9	11/16-16	7/8	22	ST	0.98	24.9	1.61	40.9	2.59	65.8	UCF6-05
UC-OFFX90-0606	36715-0606	20242633	13/32	10.3	11/16-16	7/8	22		1.50	38.0	1.65	42.0	2.70	68.6	UCF6-06
UC-OFFX90L-0606	36720-0606	20242615	13/32	10.3	11/16-16	7/8	22	LT	2.13	54.0	1.65	42.0	2.70	68.6	UCF6-06
UC-OFFX90S-0606	36725-0606	20242717	13/32	10.3	11/16-16	7/8	22	ST	0.98	25.0	1.65	42.0	2.70	68.6	UCF6-06
UC-OFFX90-0608	36715-0608	20242480	13/32	10.3	13/16-16	15/16	24		1.61	41.0	1.73	44.0	2.78	70.6	UCF6-06
UC-OFFX90L-0608	36720-0608	20242493	13/32	10.3	13/16-16	15/16	24	LT	2.52	64.0	1.85	47.0	2.90	73.6	UCF6-06
UC-OFFX90S-0608	36725-0608	20242620	13/32	10.3	13/16-16	15/16	24	ST	1.14	29.0	1.65	42.0	2.70	68.6	UCF6-06

Continued on next page

# O-Ring Face Seal (SAE J1453 ORS/ORFS)

Female | 90° Elbow | Swivel Continued

Descriptive #	Product #	SAP #	Hose Size ID		Thread Size (A)		Hex-1 Wrench Size		Elbow Type	Drop (D)		Cut-Off (C)		Length (L)		SR5, DR5, SCX5
			in.	mm	in.	mm	in.	mm		in.	mm	in.	mm	in.	mm	
UC-OFFX90-0808 <sup>C</sup>	36715-0808	20242571	1/2	12.7	13/16-16	15/16	24			1.65	42.0	1.38	35.0	2.63	66.7	UCF6-08
UC-OFFX90L-0808 <sup>C</sup>	36720-0808	20242566	1/2	12.7	13/16-16	15/16	24	LT		2.52	64.0	1.50	38.0	2.74	69.7	UCF6-08
UC-OFFX90S-0808 <sup>C</sup>	36725-0808	20242663	1/2	12.7	13/16-16	15/16	24	ST		1.14	29.0	1.58	40.0	2.82	71.7	UCF6-08
UC-OFFX90-0810	36715-0810	20242363	1/2	12.7	1-14	1 3/16	30			1.85	47.0	1.89	48.0	3.14	79.7	UCF6-08
UC-OFFX90L-0810	36720-0810	20242438	1/2	12.7	1-14	1 3/16	30	LT		2.76	70.1	1.81	46.0	3.06	77.6	UCF6-08
UC-OFFX90S-0810	36725-0810	20242550	1/2	12.7	1-14	1 3/16	30	ST		1.28	32.5	1.81	46.0	3.06	77.6	UCF6-08
UC-OFFX90S-0812	36725-0812	20318321	1/2	12.7	1 3/16-12	1 7/16	36			2.01	51.1	2.19	55.6	3.44	87.3	UCF6-08
UC-OFFX90-1010	36715-1010	20242403	5/8	15.9	1-14	1 3/16	30			1.73	44.0	2.17	55.0	3.52	89.5	UCF6-10
UC-OFFX90S-1010	36725-1010	20242365	5/8	15.9	1-14	1 3/16	30	ST		1.28	32.5	2.05	52.0	3.40	86.5	UCF6-10
UC-OFFX90S-1012	36725-1012	20242364	5/8	15.9	1 3/16-12	1 7/16	36	ST		1.93	49.0	2.17	55.1	3.53	89.6	UCF6-10

C: Crimp Nut (see "Fitting Identification" in Appendix for details)

# O-Ring Face Seal (SAE J1453 ORS/ORFS)

Male



Descriptive #	Product #	SAP #	Hose Size ID		Thread Size (A)		Hex-1 Wrench Size		Cut-Off (C)		Length (L)		GS5, DR5, SCX5
			in.	mm	in.	mm	in.	mm	in.	mm	in.	mm	
UC-OFM-0404	36730-0404	20242567	1/4	6.4	9/16-18	11/16	17		1.00	25.4	1.98	50.3	UCF6-04
UC-OFM-0406	36730-0406	20777952	1/4	6.4	11/16-16				0.96	24.3	1.94	49.1	UCF6-04
UC-OFM-0606	36730-0606	20242596	13/32	10.3	11/16-16	3/4	19		1.05	26.7	2.10	53.4	UCF6-06
UC-OFM-0608	36730-0608	20242575	13/32	10.3	13/16-16	7/8	22		1.05	26.6	2.10	53.2	UCF6-06
UC-OFM-0808	36730-0808	20242545	1/2	12.7	13/16-16	7/8	22		1.19	30.3	2.44	62.0	UCF6-08
UC-OFM-0810	36730-0810	20242369	1/2	12.7	1-14	1 1/16	27		1.21	30.7	2.46	62.4	UCF6-08
UC-OFM-0812	36730-0812	20242368	1/2	12.7	1 3/16-12	1 1/4	32		1.34	34.0	2.59	65.7	UCF6-08

# O-Ring Boss Straight Thread (SAE J514)

Male

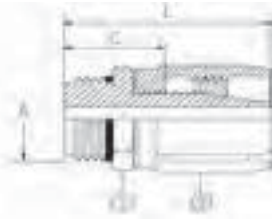

Descriptive #	Product #	SAP #	Hose Size ID		Thread Size (A)	Hex-1 Wrench Size	Socket (S) Wrench Size	Cut-Off (C)		Length (L)		SR5, DR5
			in.	mm	in.	in.	in.	mm	in.	mm		
FG-OBM-0404	18670-0404	20245788	3/16	4.8	7/16-20	9/16	5/8	0.89	22.6	1.64	41.7	Y
FG-OBM-0505	18670-0505	20245789	1/4	6.4	1/2-20	5/8	11/16	0.97	24.6	1.75	44.5	Y
FG-OBM-0606	18670-0606	20245790	5/16	7.9	9/16-18	11/16	13/16	1.03	26.2	1.94	49.2	Y
FG-OBM-0808	18670-0808	20245791	13/32	10.3	3/4-16	7/8	15/16	1.09	27.8	2.34	59.5	Y
FG-OBM-1010	18670-1010	20245783	1/2	12.7	7/8-14	1	1 <sup>1</sup> / <sub>8</sub>	1.23	31.4	2.62	66.7	Y
FG-OBM-1212	18670-1212	20245784	5/8	15.9	1 <sup>1</sup> / <sub>16</sub> -12	1 <sup>1</sup> / <sub>4</sub>	1 <sup>1</sup> / <sub>4</sub>	1.53	38.9	3.09	78.6	Y
FG-OBM-1616	18670-1616	20245785	7/8	22.2	1 <sup>5</sup> / <sub>16</sub> -12	1 <sup>1</sup> / <sub>2</sub>	1 <sup>1</sup> / <sub>16</sub>	1.39	35.3	2.66	67.5	Y
FG-OBM-2020	18670-2020	20245786	1 <sup>1</sup> / <sub>8</sub>	28.6	1 <sup>3</sup> / <sub>8</sub> -12	1 <sup>7</sup> / <sub>8</sub>	1 <sup>3</sup> / <sub>4</sub>	1.39	35.3	2.75	69.9	Y
FG-OBM-2424	18670-2424	20245787	1 <sup>1</sup> / <sub>2</sub>	34.9	1 <sup>7</sup> / <sub>8</sub> -12	2 <sup>1</sup> / <sub>8</sub>	2	1.39	35.3	2.84	72.2	Y

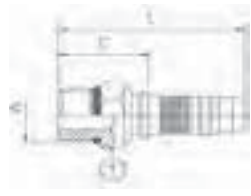

Descriptive #	Product #	SAP #	Hose Size ID		Thread Size (A)	Hex-1 Wrench Size	Cut-Off (C)		Length (L)		SR5, DR5, SCX5	
			in.	mm	in.	mm	in.	mm	in.	mm		
UC-OBM-0404	36670-0404	20242597	1/4	6.4	7/16-20	9/16	14	0.88	22.3	1.86	47.2	UCF6-04
UC-OBM-0405	36670-0405	20242531	1/4	6.4	1/2-20	5/8	16	0.88	22.3	1.86	47.2	UCF6-04
UC-OBM-0406	36670-0406	20242591	1/4	6.4	9/16-18	11/16	17	0.88	22.3	1.86	47.2	UCF6-04
UC-OBM-0606	36670-0606	20242677	13/32	10.3	9/16-18	3/4	19	0.94	23.7	1.98	50.4	UCF6-06
UC-OBM-0608	36670-0608	20242672	13/32	10.3	3/4-16	7/8	22	0.73	18.6	2.04	51.7	UCF6-06
UC-OBM-0610	36670-0610	20242614	13/32	10.3	7/8-14	1 <sup>1</sup> / <sub>16</sub>	27	1.08	27.4	2.13	54.1	UCF6-06
UC-OBM-0808	36670-0808	20242665	1/2	12.7	3/4-16	7/8	22	1.01	25.6	2.26	57.3	UCF6-08
UC-OBM-0810	36670-0810	20242595	1/2	12.7	7/8-14	1 <sup>1</sup> / <sub>16</sub>	27	1.10	27.9	2.35	59.6	UCF6-08
UC-OBM-0812	36670-0812	20242476	1/2	12.7	1 <sup>1</sup> / <sub>16</sub> -12	1 <sup>1</sup> / <sub>4</sub>	32	1.26	32.1	2.51	63.8	UCF6-08

## O-Ring Boss Straight Thread (SAE J514)

Male | Swivel

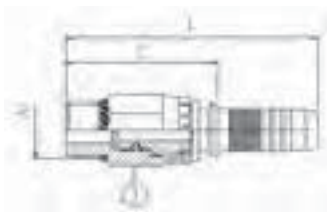

Descriptive #	Product #	SAP #	Hose Size ID		Thread Size (A)	Hex-1 Wrench Size		Cut-Off (C)		Length (L)		SR5, DR5, SCX5
			in.	mm		in.	mm	in.	mm	in.	mm	
UC-OBMX-0608	36680-0608	20318237	13/32	10.3	3/4-16	1	25	1.73	44.0	2.78	70.6	UCF6-06
UC-OBMX-0808	36680-0808	20318238	1/2	12.7	3/4-16	1	25	1.68	42.7	2.93	74.4	UCF6-08
UC-OBMX-0810	36680-0810	20318239	1/2	12.7	7/8-14	1	25	1.69	42.9	2.94	74.6	UCF6-08

## O-Ring Boss Straight Thread (SAE J514)

Male | 90° Elbow (Block) | Swivel



Descriptive #	Product #	SAP #	Hose Size ID		Thread Size (A)	Hex-1 Wrench Size		Drop (D)		Cut-Off (C)		Length (L)		SR5, DR5, SCX5
			in.	mm		in.	mm	in.	mm	in.	mm	in.	mm	
UC-OBMX90B-0405	36685-0405	20318354	1/4	6.4	1/2-20	11/16	17	1.48	37.6	0.71	18.1	1.69	43.0	UCF6-04
UC-OBMX90B-0606	36685-0606	20318355	13/32	10.3	9/16-18	7/8	22	1.74	44.3	0.92	23.3	1.97	50.0	UCF6-06
UC-OBMX90B-0608	36685-0608	20318356	13/32	10.3	3/4-16	1	25	2.17	55.0	1.13	28.8	2.18	55.4	UCF6-06
UC-OBMX90B-0808	36685-0808	20318357	1/2	12.7	3/4-16	1	25	2.17	55.0	1.16	29.4	2.41	61.1	UCF6-08
UC-OBMX90B-0810	36685-0810	20318358	1/2	12.7	7/8-14	1	25	2.17	55.2	1.16	29.4	2.41	61.1	UCF6-08

## Code 61 Flange (SAE J518)



Descriptive #	Product #	SAP #	Hose Size ID		Flange Size	Cut-Off (C)		Length (L)		GS5, DR5, SCX5
			in.	mm		in.	mm	in.	mm	
UC-FL-0808	36320-0808	20242569	1/2	12.7	1/2	1.61	40.9	2.86	72.6	UCF6-08
UC-FL-0812	36320-0812	20242300	1/2	12.7	3/4	1.65	41.9	2.90	73.6	UCF6-08

## Code 61 Flange (SAE J518)

45° Elbow

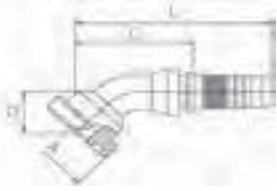

Descriptive #	Product #	SAP #	Hose Size ID		Flange Size	Drop (D)		Cut-Off (C)		Length (L)		GS5, DR5, SCX5
			in.	mm	in.	in.	mm	in.	mm	in.	mm	
UC-FL45-0808	36340-0808	20242508	1/2	12.7	1/2	0.87	22.1	2.09	53.1	3.34	84.8	UCF6-08
UC-FL45-0812	36340-0812	20242293	1/2	12.7	3/4	1.02	25.9	2.36	59.9	3.61	91.6	UCF6-08

## Code 61 Flange (SAE J518)

90° Elbow



Descriptive #	Product #	SAP #	Hose Size ID		Flange Size	Drop (D)		Cut-Off (C)		Length (L)		GS5, DR5, SCX5
			in.	mm	in.	in.	mm	in.	mm	in.	mm	
UC-FL90-0808	36350-0808	20242537	1/2	12.7	1/2	1.65	41.9	1.81	46.0	3.06	77.6	UCF6-08
UC-FL90-0812	36350-0812	20242381	1/2	12.7	3/4	2.01	51.1	1.77	45.0	3.02	76.6	UCF6-08

## Code 62 Flange (SAE J518)

90° Elbow

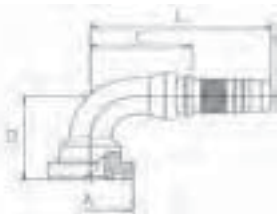

Descriptive #	Product #	SAP #	Hose Size ID		Flange Size	Drop (D)		Cut-Off (C)		Length (L)		GS5, DR5, SCX5
			in.	mm	in.	in.	mm	in.	mm	in.	mm	
UC-FH90-0808	36315-0808	20242306	1/2	12.7	1/2	1.81	46.0	1.89	48.0	3.32	84.3	UCF6-08



## BSPB (British Standard Pipe Parallel)

Female | Swivel

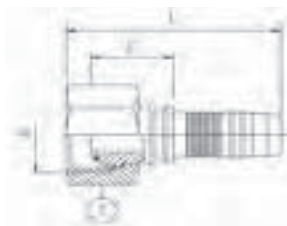

Descriptive #	Product #	SAP #	Hose Size ID		Thread Size (A)	Hex-1 Wrench Size		Cut-Off (C)		Length (L)		GS5, DR5, SCX5
			in.	mm		in.	mm	in.	mm	in.	mm	
UC-BPFX-0404	36105-0404	20242738	1/4	6.4	1/4-19	3/4	19	0.93	23.7	1.91	48.6	UCF6-04
UC-BPFX-0406	36105-0406	20242462	1/4	6.4	3/8-19	7/8	22	1.09	27.6	2.07	52.5	UCF6-04
UC-BPFX-0606	36105-0606	20242731	13/32	10.3	3/8-19	7/8	22	1.09	27.8	2.14	54.4	UCF6-06
UC-BPFX-0608	36105-0608	20242557	13/32	10.3	1/2-14	1 1/16	27	1.20	30.4	2.24	57.0	UCF6-06
UC-BPFX-0808	36105-0808	20242715	1/2	12.7	1/2-14	1 1/16	27	1.22	31.0	2.47	62.7	UCF6-08
UC-BPFX-0810	36105-0810	20242406	1/2	12.7	5/8-14	1 1/16	27	1.48	37.6	2.73	69.3	UCF6-08

## BSPB (British Standard Pipe Parallel)

Female | 45° Elbow | Swivel

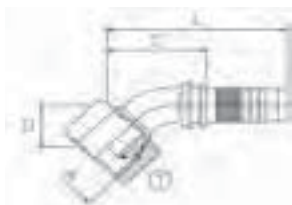

Descriptive #	Product #	SAP #	Hose Size ID		Thread Size (A)	Hex-1 Wrench Size		Drop (D)		Cut-Off (C)		Length (L)		GS5, DR5, SCX5
			in.	mm		in.	mm	in.	mm	in.	mm	in.	mm	
UC-BPFX45-0404	36115-0404	20242444	1/4	6.4	1/4-19	3/4	19	0.59	15.0	1.81	46.0	2.79	70.9	UCF6-04
UC-BPFX45-0606	36115-0606	20242496	13/32	10.3	3/8-19	7/8	22	0.81	20.6	1.97	50.0	3.02	76.7	UCF6-06
UC-BPFX45-0808	36115-0808	20242803	1/2	12.7	1/2-14	1 1/16	27	0.83	21.1	2.17	55.1	3.42	86.8	UCF6-08

## BSPB (British Standard Pipe Parallel)

Female | 90° Elbow | Swivel

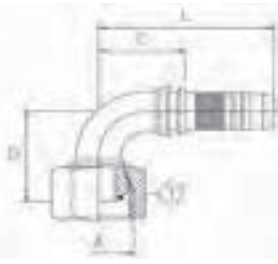

Descriptive #	Product #	SAP #	Hose Size ID		Thread Size (A)	Hex-1 Wrench Size		Drop (D)		Cut-Off (C)		Length (L)		GS5, DR5, SCX5
			in.	mm		in.	mm	in.	mm	in.	mm	in.	mm	
UC-BPFX90-0404	36120-0404	20242536	1/4	6.4	1/4-19	3/4	19	1.14	29.0	1.14	29.0	2.12	53.8	UCF6-04
UC-BPFX90-0606	36120-0606	20242610	13/32	10.3	3/8-19	7/8	22	1.65	41.9	1.38	35.1	2.43	61.7	UCF6-06
UC-BPFX90-0608	36120-0608	20242805	13/32	10.3	1/2-14	1 1/16	27	1.40	35.6	1.34	34.0	2.39	60.7	UCF6-06
UC-BPFX90-0808	36120-0808	20242556	1/2	12.7	1/2-14	1 1/16	27	1.61	40.9	1.42	36.1	2.67	67.7	UCF6-08

## BSPB (British Standard Pipe Parallel)

Male



Descriptive #	Product #	SAP #	Hose Size ID		Thread Size (A)	Hex-1 Wrench Size		Cut-Off (C)		Length (L)		GS5, DR5, SCX5
			in.	mm		in.	mm	in.	mm	in.	mm	
UC-BPM-0404	36130-0404	20242484	1/4	6.4	1/4-19	3/4	19	1.03	26.2	2.01	51.1	UCF6-04
UC-BPM-0606	36130-0606	20242581	13/32	10.3	3/8-19	7/8	22	1.10	28.0	2.15	54.6	UCF6-06
UC-BPM-0608	36130-0608	20242464	13/32	10.3	1/2-14	1 1/16	27	1.24	31.5	2.29	58.1	UCF6-06
UC-BPM-0806	36130-0806	20242809	1/2	12.7	3/8-19	7/8	22	1.12	28.5	2.37	60.2	UCF6-08
UC-BPM-0808	36130-0808	20242463	1/2	12.7	1/2-14	1 1/16	27	1.26	32.0	2.51	63.7	UCF6-08

## BSPT (British Standard Pipe Tapered)

Male

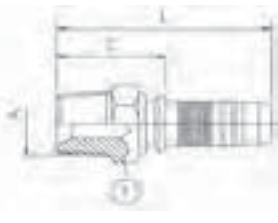

Descriptive #	Product #	SAP #	Hose Size ID		Thread Size (A)	Hex-1 Wrench Size		Cut-Off (C)		Length (L)		GS5, DR5, SCX5
			in.	mm		in.	mm	in.	mm	in.	mm	
UC-BTM-0404	36170-0404	20242611	1/4	6.4	1/4-19	1 1/16	17	1.06	27.0	2.04	51.9	UCF6-04
UC-BTM-0606	36170-0606	20242612	13/32	10.3	3/8-19	3/4	19	1.10	27.9	2.15	54.6	UCF6-06
UC-BTM-0808	36170-0808	20242507	1/2	12.7	1/2-14	7/8	22	1.31	33.1	2.55	64.8	UCF6-08

## BSP Flat Seat (British Standard Pipe)

Female | Swivel

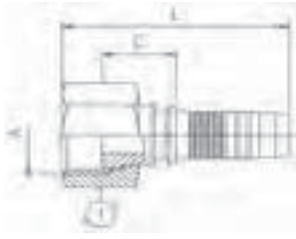

Descriptive #	Product #	SAP #	Hose Size ID		Thread Size (A)	Hex-1 Wrench Size		Cut-Off (C)		Length (L)		GS5, DR5, SCX5
			in.	mm		in.	mm	in.	mm	in.	mm	
UC-BFFX-0606	36100-0606	20242800	13/32	10.3	3/8-19	7/8	22	0.75	19.0	1.80	45.6	UCF6-06
UC-BFFX-0608	36100-0608	20242799	13/32	10.3	1/2-14	1 1/16	27	0.80	20.2	1.84	46.8	UCF6-06
UC-BFFX-0808	36100-0808	20242798	1/2	12.7	1/2-14	1 1/16	27	0.82	20.9	2.07	52.5	UCF6-08
UC-BFFX-0812	36100-0812	20242285	1/2	12.7	3/4-14	1 1/4	32	0.97	24.5	2.21	56.2	UCF6-08

## DIN 24° Light

Female | Swivel

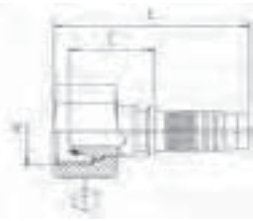

Descriptive #	Product #	SAP #	Hose Size ID		Thread Size (A)	Hex-1 Wrench Size	Cut-Off (C)		Length (L)		GS5, DR5, SCX5
			in.	mm			in.	mm	in.	mm	
UC-DLFX-0412T	36240-0412	20242540	1/4	6.4	12x1.5	14	1.07	27.2	2.05	52.0	UCF6-04
UC-DLFX-0414	36240-0414	20242594	1/4	6.4	14x1.5	17	1.02	25.9	2.00	50.8	UCF6-04
UC-DLFX-0416	36240-0416	20242471	1/4	6.4	16x1.5	19	1.08	27.4	2.06	52.2	UCF6-04
UC-DLFX-0616	36240-0616	20242658	13/32	10.3	16x1.5	19	2.21	56.2	2.26	57.5	UCF6-06
UC-DLFX-0618	36240-0618	20242641	13/32	10.3	18x1.5	22	1.08	27.5	2.13	54.2	UCF6-06
UC-DLFX-0822	36240-0822	20242586	1/2	12.7	22x1.5	27	1.21	30.7	2.46	62.4	UCF6-08

T: Thrust-Wire Nut (see "Fitting Identification" in Appendix for details)

## DIN 24° Light

Female | 45° Elbow | Swivel

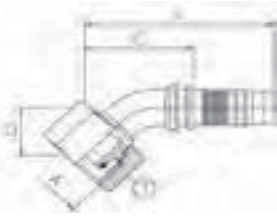

Descriptive #	Product #	SAP #	Hose Size ID		Thread Size (A)	Hex-1 Wrench Size	Drop (D)		Cut-Off (C)		Length (L)		GS5, DR5, SCX5
			in.	mm		mm	in.	mm	in.	mm	in.	mm	
UC-DLFX45-0414	36245-0414	20242385	1/4	6.4	14x1.5	17	0.69	17.5	1.69	42.9	2.67	67.8	UCF6-04
UC-DLFX45-0416	36245-0416	20242386	1/4	6.4	16x1.5	19	0.79	20.1	1.65	41.9	2.63	66.8	UCF6-04
UC-DLFX45-0618	36245-0618	20242387	13/32	10.3	18x1.5	22	0.77	19.6	1.85	47.0	2.90	73.6	UCF6-06
UC-DLFX45-0822	36245-0822	20242329	1/2	12.7	22x1.5	27	0.83	21.1	2.17	55.1	3.15	79.9	UCF6-08

## DIN 24° Light

Female | 90° Elbow | Swivel

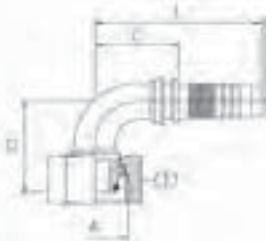

Descriptive #	Product #	SAP #	Hose Size ID		Thread Size (A)	Hex-1 Wrench Size	Drop (D)		Cut-Off (C)		Length (L)		GS5, DR5, SCX5
			in.	mm		mm	in.	mm	in.	mm	in.	mm	
UC-DLFX90-0412	36250-0412	20242390	1/4	6.4	12x1.5	14	1.02	25.9	1.14	29.0	2.12	53.8	UCF6-04
UC-DLFX90-0414	36250-0414	20242425	1/4	6.4	14x1.5	17	1.28	32.5	1.10	27.9	2.08	52.8	UCF6-04
UC-DLFX90-0416	36250-0416	20242391	1/4	6.4	16x1.5	19	1.28	32.5	1.10	27.9	2.08	52.8	UCF6-04
UC-DLFX90-0618	36250-0618	20242488	13/32	10.3	18x1.5	22	1.54	39.1	1.30	33.0	2.35	59.7	UCF6-06
UC-DLFX90-0822	36250-0822	20242389	1/2	12.7	22x1.5	27	1.59	40.4	1.57	39.9	2.82	71.6	UCF6-08

# DIN 24° Light

Male



Descriptive #	Product #	SAP #	Hose Size ID		Thread Size (A)	Hex-1 Wrench Size	Cut-Off (C)		Length (L)		GS5, DR5, SCX5
			in.	mm			in.	mm	in.	mm	
UC-DLM-0412	36255-0412	20242334	1/4	6.4	12x1.5	14	0.84	21.4	1.82	46.3	UCF6-04
UC-DLM-0414	36255-0414	20242393	1/4	6.4	14x1.5	14	0.84	21.4	1.82	46.3	UCF6-04
UC-DLM-0416	36255-0416	20242335	1/4	6.4	16x1.5	17	0.92	23.4	1.90	48.3	UCF6-04
UC-DLM-0616	36255-0616	20242426	13/32	10.3	16x1.5	17	0.93	23.6	1.98	50.2	UCF6-06
UC-DLM-0618	36255-0618	20242513	13/32	10.3	18x1.5	19	0.96	24.4	2.01	51.1	UCF6-06
UC-DLM-0822	36255-0822	20242392	1/2	12.7	22x1.5	22	1.02	26.0	2.27	57.6	UCF6-08

# DIN 24° Heavy

Female | Swivel

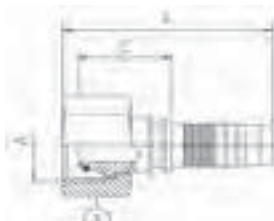

Descriptive #	Product #	SAP #	Hose Size ID		Thread Size (A)	Hex-1 Wrench Size	Cut-Off (C)		Length (L)		GS5, DR5, SCX5
			in.	mm			in.	mm	in.	mm	
UC-DHFX-0416	36210-0416	20242538	1/4	6.4	16x1.5	19	1.20	30.5	2.18	55.4	UCF6-04
UC-DHFX-0418	36210-0418	20242529	1/4	6.4	18x1.5	22	1.21	30.8	2.19	55.7	UCF6-04
UC-DHFX-0620	36210-0620	20242624	13/32	10.3	20x1.5	24	1.21	30.8	2.26	57.4	UCF6-06
UC-DHFX-0622	36210-0622	20242562	13/32	10.3	22x1.5	27	1.42	36.2	2.47	62.8	UCF6-06
UC-DHFX-0824	36210-0824	20242561	1/2	12.7	24x1.5	30	1.44	36.5	2.68	68.2	UCF6-08

## DIN 24° Heavy

Female | 45° Elbow | Swivel



Descriptive #	Product #	SAP #	Hose Size ID		Thread Size (A)	Hex-1 Wrench Size	Drop (D)		Cut-Off (C)		Length (L)		GS5, DR5, SCX5
			in.	mm			in.	mm	in.	mm	in.	mm	
UC-DHFX45-0418	36215-0418	20242313	1/4	6.4	18x1.5	22	0.75	19.1	1.69	42.9	2.67	67.8	UCF6-04
UC-DHFX45-0620	36215-0620	20242315	13/32	10.3	20x1.5	24	0.79	20.1	2.01	51.1	3.06	77.7	UCF6-06
UC-DHFX45-0622	36215-0622	20242316	13/32	10.3	22x1.5	27	0.83	21.1	2.09	53.1	3.14	79.7	UCF6-06
UC-DHFX45-0824	36215-0824	20242312	1/2	12.7	24x1.5	30	0.85	21.6	2.20	55.9	3.45	87.6	UCF6-08

## DIN 24° Heavy

Female | 90° Elbow | Swivel

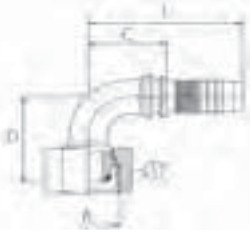

Descriptive #	Product #	SAP #	Hose Size ID		Thread Size (A)	Hex-1 Wrench Size	Drop (D)		Cut-Off (C)		Length (L)		GS5, DR5, SCX5
			in.	mm			in.	mm	in.	mm	in.	mm	
UC-DHFX90-0418	36220-0418	20242421	1/4	6.4	18x1.5	22	1.34	34.0	1.06	26.9	2.04	51.8	UCF6-04
UC-DHFX90-0620	36220-0620	20242563	13/32	10.3	20x1.5	24	1.52	38.6	1.34	34.0	2.39	60.7	UCF6-06
UC-DHFX90-0622	36220-0622	20242469	13/32	10.3	22x1.5	27	1.59	40.4	1.34	34.0	2.39	60.7	UCF6-06
UC-DHFX90-0824	36220-0824	20242468	1/2	12.7	24x1.5	30	1.63	41.4	1.57	39.9	2.82	71.6	UCF6-08

## DIN 24° Heavy

Male

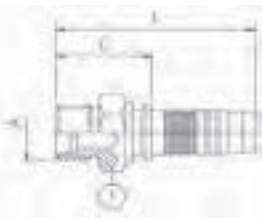

Descriptive #	Product #	SAP #	Hose Size ID		Thread Size (A)	Hex-1 Wrench Size	Cut-Off (C)		Length (L)		GS5, DR5, SCX5
			in.	mm			in.	mm	in.	mm	
UC-DHM-0416	36225-0416	20242323	1/4	6.4	16x1.5	17	0.95	24.2	1.93	49.1	UCF6-04
UC-DHM-0418	36225-0418	20242324	1/4	6.4	18x1.5	19	0.99	25.2	1.97	50.1	UCF6-04
UC-DHM-0620	36225-0620	20242424	13/32	10.3	20x1.5	22	1.00	25.4	2.05	52.1	UCF6-06
UC-DHM-0622	36225-0622	20242470	13/32	10.3	22x1.5	22	1.08	27.4	2.13	54.1	UCF6-06
UC-DHM-0824	36225-0824	20242322	1/2	12.7	24x1.5	24	1.14	29.0	2.39	60.7	UCF6-08

## DIN 60°

Female | 45° Elbow | Swivel

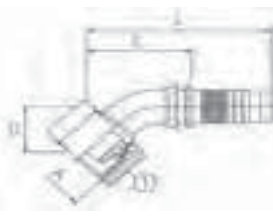

Descriptive #	Product #	SAP #	Hose Size ID		Thread Size (A)	Hex-1 Wrench Size	Drop (D)		Cut-Off (C)		Length (L)		GS5, DR5, SCX5
			in.	mm			in.	mm	in.	mm	in.	mm	
UC-DNFX45-0414	36275-0414	20242338	1/4	6.4	14x1.5	17	0.63	16.0	1.38	35.1	2.36	59.9	UCF6-04
UC-DNFX45-0416	36275-0416	20242339	1/4	6.4	16x1.5	19	0.67	17.0	1.42	36.1	2.40	61.0	UCF6-04
UC-DNFX45-0618	36275-0618	20242340	13/32	10.3	18x1.5	22	0.77	19.6	1.69	42.9	2.74	69.6	UCF6-06
UC-DNFX45-0822	36275-0822	20242337	1/2	12.7	22x1.5	27	0.79	20.1	2.17	55.1	3.42	86.8	UCF6-08

## DIN 60°

Female | 90° Elbow | Swivel

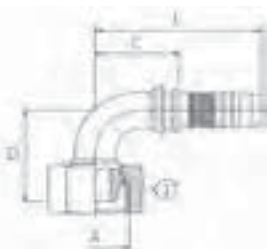

Descriptive #	Product #	SAP #	Hose Size ID		Thread Size (A)	Hex-1 Wrench Size	Drop (D)		Cut-Off (C)		Length (L)		GS5, DR5, SCX5
			in.	mm			in.	mm	in.	mm	in.	mm	
UC-DNFX90-0414	36280-0414	20242428	1/4	6.4	14x1.5	17	1.28	32.5	1.18	30.0	2.16	54.9	UCF6-04
UC-DNFX90-0416	36280-0416	20242341	1/4	6.4	16x1.5	19	1.28	32.5	1.10	27.9	2.08	52.8	UCF6-04
UC-DNFX90-0616	36280-0616	20242342	13/32	10.3	16x1.5	19	1.26	32.0	1.18	30.0	2.23	56.6	UCF6-06
UC-DNFX90-0618	36280-0618	20242472	13/32	10.3	18x1.5	22	1.46	37.1	1.30	33.0	2.35	59.7	UCF6-06
UC-DNFX90-0822	36280-0822	20242427	1/2	12.7	22x1.5	27	1.57	39.9	1.57	39.9	2.82	71.6	UCF6-08

## Japanese Komatsu® 30° Flare with Metric Threads

Female | Swivel

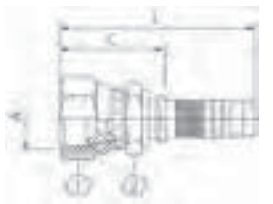

Descriptive #	Product #	SAP #	Hose Size ID		Thread Size (A)	Hex-1 Wrench Size	Hex-2 Wrench Size	Cut-Off (C)		Length (L)		GS5, DR5, SCX5
			in.	mm				in.	mm	in.	mm	
UC-KMFX-0414	36545-0414	20242590	1/4	6.4	14X1.5	19	17	1.22	30.9	2.20	55.8	UCF6-04
UC-KMFX-0618	36545-0618	20242636	13/32	10.3	18X1.5	22	19	1.26	32.1	2.31	58.7	UCF6-06
UC-KMFX-0822	36545-0822	20242573	1/2	12.7	22X1.5	27	22	1.38	35.2	2.63	66.8	UCF6-08
UC-KMFX-1024	36545-1024	20283390	5/8	15.9	24X1.5	32	30	1.66	42.2	3.02	76.6	UCF6-10

## Japanese Komatsu® 30° Flare with Metric Threads Female | 45° Elbow | Swivel

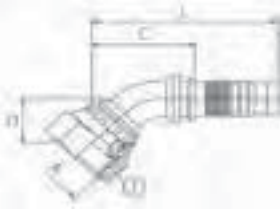

Descriptive #	Product #	SAP #	Hose Size ID		Thread Size (A)	Hex-1 Wrench Size	Drop (D)		Cut-Off (C)		Length (L)		GS5, DR5, SCX5
			in.	mm	mm	in.	mm	in.	mm	in.	mm		
UC-KMFX45-0414	36548-0414	20318233	1/4	6.4	14X1.5	19	0.61	15.5	1.50	38.1	2.48	63.0	UCF6-04
UC-KMFX45-0618	36548-0618	20318234	13/32	10.3	18X1.5	22	0.71	18.0	1.73	43.9	2.78	70.6	UCF6-06
UC-KMFX45-0822	36548-0822	20318235	1/2	12.7	22X1.5	27	1.16	29.5	2.20	55.9	3.45	87.6	UCF6-08

## Japanese Komatsu® 30° Flare with Metric Threads Female | 90° Elbow | Swivel

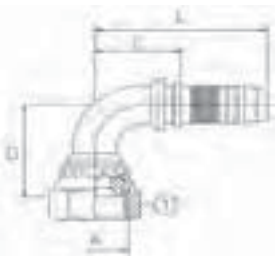

Descriptive #	Product #	SAP #	Hose Size ID		Thread Size (A)	Hex-1 Wrench Size	Drop (D)		Cut-Off (C)		Length (L)		GS5, DR5, SCX5
			in.	mm	mm	in.	mm	in.	mm	in.	mm		
UC-KMFX90-0414	36550-0414	20318236	1/4	6.4	14X1.5	19	1.16	29.5	1.30	33.0	2.28	57.9	UCF6-04
UC-KMFX90-0618	36550-0618	20318326	13/32	10.3	18X1.5	22	1.40	35.6	1.42	36.1	2.47	62.7	UCF6-06
UC-KMFX90-0822	36550-0822	20318327	1/2	12.7	22X1.5	27	2.09	53.1	1.74	44.1	2.98	75.8	UCF6-08

## JIS 30° (Parallel Pipe Threads) Female | Swivel

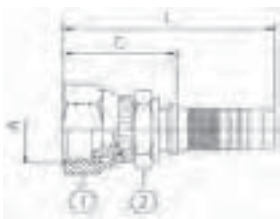

Descriptive #	Product #	SAP #	Hose Size ID		Thread Size (A)	Hex-1 Wrench Size	Hex-2 Wrench Size	Cut-Off (C)		Length (L)		GS5, DR5, SCX5		
			in.	mm	in.	mm	in.	mm	in.	mm				
UC-JSFX-0404	36520-0404	20242644	1/4	6.4	1/4-19	3/4	19	11/16	17	1.22	30.9	2.20	55.8	UCF6-04
UC-JSFX-0606	36520-0606	20242699	13/32	10.3	3/8-19	7/8	22	3/4	19	1.26	32.1	2.31	58.7	UCF6-06
UC-JSFX-0808	36520-0808	20242606	1/2	12.7	1/2-14	1 1/16	27	7/8	22	1.39	35.2	2.63	66.9	UCF6-08



## How to Use the Fitting Tables

This section lists ALL fittings that are compatible with the following hoses:

Hose Family	Hose Descriptive
DUT	Universal Truck (SAE J1402 Type A1)

## Fitting Description

Fitting Type

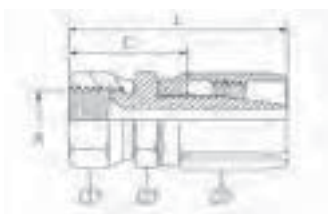

Descriptive #	Product #	SAP #	Hose Size ID		Thread Size		Hex-1 Wrench Size		Hex-2 Wrench Size		Socket Hex (S) Wrench Size		Cut-Off (C)		Length (L)		DUT
			in.	mm	in.	mm	in.	mm	in.	mm	in.	mm	in.	mm	in.	mm	
Universal Truck, PN1 <sup>DS</sup>	38400-0404	20419786	3/16	4.8	7/16-20	1/2	12.7	9/16	14.3	9/16	1.10	27.9	1.82	46.2	Y		
Universal Truck, PN2 <sup>DS</sup>	38400-0505	20419787	1/4	6.4	1/2-20	1/2	12.7	11/16	17.5	5/8	1.21	30.7	2.00	50.8	Y		
Universal Truck, PN3	38400-0606	20419788	5/16	7.9	9/16-18	3/4	19.1	3/4	19.1	3/4	1.19	30.2	2.04	51.8	Y		

DS: Dual Seat - Connects to either SAE 45° or JIC 37° male fitting

Choose fittings carefully, considering the working pressure of both hose and fitting. The maximum working pressure of the hose assembly is the lesser of the rated working pressure of the hose and the fitting. See page 300 for working pressure.

A "Y" in the hose compatibility columns indicates that the fitting is a "UT" style fitting and that it works for that particular hose.

## JIC 37° Flare (SAE J514)

Female | Swivel

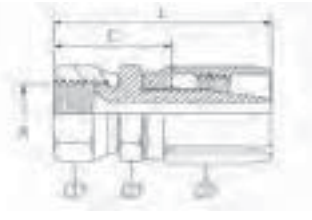

Descriptive #	Product #	SAP #	Hose Size ID		Thread Size	Hex-1 Wrench Size		Hex-2 Wrench Size		Socket Hex (S) Wrench Size		Cut-Off (C)		Length (L)		DUT
			in.	mm		in.	mm	in.	mm	in.	mm	in.	mm	in.	mm	
UT-JCFX-0404 <sup>DS</sup>	38400-0404	20419786	3/16	4.8	7/16-20	1/2	12.7	9/16	14.3	9/16		1.10	27.9	1.82	46.2	Y
UT-JCFX-0505 <sup>DS</sup>	38400-0505	20419787	1/4	6.4	1/2-20	1/2	12.7	11/16	17.5	5/8		1.21	30.7	2.00	50.8	Y
UT-JCFX-0606	38400-0606	20419788	5/16	7.9	9/16-18	3/4	19.1	3/4	19.1	3/4		1.19	30.2	2.04	51.8	Y
UT-JCFX-0808 <sup>DS</sup>	38400-0808	20419789	13/32	10.3	3/4-16	7/8	22.2	7/8	22.2	7/8		1.45	36.8	2.45	62.2	Y
UT-JCFX-1010 <sup>DS</sup>	38400-1010	20419801	1/2	12.7	7/8-14	1 1/16	27.0	1 1/16	27.0	1		1.65	41.9	2.72	69.1	Y
UT-JCFX-1212	38400-1212	20419803	5/8	15.9	1 1/16-12	1 1/4	31.8	1 1/4	31.8	1 1/8		1.78	45.2	2.92	74.2	Y
UT-JCFX-1616	38400-1616	20419804	7/8	22.2	1 5/16-12	1 1/2	38.1	1 1/2	38.1	1 1/8		1.84	46.7	2.90	73.7	Y
UT-JCFX-2020	38400-2020	20419806	1 1/8	28.6	1 5/8-12	1 3/4	39.7	2	50.8	1 1/8		2.20	55.9	3.34	84.8	Y

DS: Dual Seat - Connects to either SAE 45° or JIC 37° male fitting

## JIC 37° Flare (SAE J514)

Female | 45° Elbow | Swivel

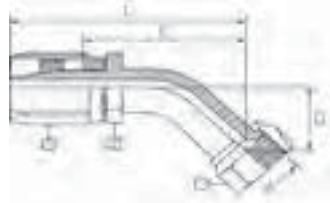

Descriptive #	Product #	SAP #	Hose Size ID		Thread Size	Hex-1 Wrench Size		Hex-2 Wrench Size		Socket (S) Wrench Size	Drop (D)		Cut-Off (C)		Length (L)		DUT
			in.	mm		in.	mm	in.	mm	in.	mm	in.	mm	in.	mm		
UT-JCFX45-0404 <sup>DS</sup>	38420-0404	20419746	3/16	4.8	7/16-20	1/2	12.7	9/16	14.3	9/16	0.34	8.6	1.20	30.5	1.92	48.8	Y
UT-JCFX45-0606	38420-0606	20419747	5/16	7.9	9/16-18	1/2	12.7	11/16	17.5	3/4	0.41	10.4	1.48	37.6	2.33	59.2	Y
UT-JCFX45-0808 <sup>DS</sup>	38420-0808	20419749	13/32	10.3	3/4-16	11/16	17.5	7/8	22.2	7/8	0.56	14.2	1.73	43.9	2.73	69.3	Y
UT-JCFX45-1010 <sup>DS</sup>	38420-1010	20419750	1/2	12.7	7/8-14	3/4	19.1	1	25.4	1	0.63	16.0	2.11	53.6	3.17	80.5	Y
UT-JCFX45-1212	38420-1212	20419751	5/8	15.9	1 1/16-12	7/8	22.2	1 1/4	31.8	1 1/8	0.78	19.8	2.49	63.2	3.63	92.2	Y

DS: Dual Seat - Connects to either SAE 45° or JIC 37° male fitting

# JIC 37° Flare (SAE J514)

Female | 90° Elbow | Swivel

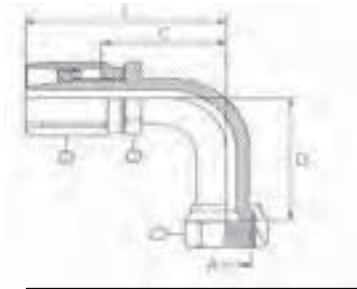

Descriptive #	Product #	SAP #	Hose Size ID		Thread Size	Hex-1 Wrench Size		Hex-2 Wrench Size		Socket (S) Wrench Size		Drop (D)		Cut-Off (C)		Length (L)		DUT
			in.	mm		in.	mm	in.	mm	in.	mm	in.	mm	in.	mm	in.	mm	
UT-JCFX90-0404 <sup>DS</sup>	38425-0404	20419742	3/16	4.8	7/16-20	1/2	12.7	9/16	14.3	9/16		0.69	17.5	1.00	25.4	1.72	43.7	Y
UT-JCFX90-0606	38425-0606	20419538	5/16	7.9	9/16-18	1/2	12.7	11/16	17.5	3/4		0.84	21.3	1.36	34.5	2.21	56.1	Y
UT-JCFX90-0808 <sup>DS</sup>	38425-0808	20419743	13/32	10.3	3/4-16	11/16	17.5	7/8	22.2	7/8		1.09	27.7	1.54	39.1	2.54	64.5	Y
UT-JCFX90-1010 <sup>DS</sup>	38425-1010	20419744	1/2	12.7	7/8-14	3/4	19.1	1	25.4	1		1.25	31.8	1.91	48.5	2.97	75.4	Y
UT-JCFX90-1212	38425-1212	20419535	5/8	15.9	1 1/16-12	7/8	22.2	1 1/4	31.8	1 1/8		1.81	46.0	2.44	62.0	3.58	90.9	Y
UT-JCFX90-1616	38425-1616	20419537	7/8	22.2	1 5/16-12	1 1/4	31.8	1 1/2	38.1	1 1/8		2.16	54.9	2.66	67.6	3.72	94.5	Y

DS: Dual Seat - Connects to either SAE 45° or JIC 37° male fitting

# SAE 45° J512 Flare

Female | Swivel

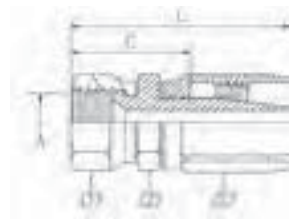

Descriptive #	Product #	SAP #	Hose Size ID		Thread Size	Hex-1 Wrench Size		Hex-2 Wrench Size		Socket Hex (S) Wrench Size	Cut-Off (C)		Length (L)		DUT	
			in.	mm		in.	mm	in.	mm		in.	mm	in.	mm		
UT-SFFX-0606	38775-0606	20419782	5/16	7.9	5/8-18	3/4	19.1	3/4	19.1	3/4		1.28	32.5	2.13	54.1	Y
UT-SFFX-1212	38775-1212	20419784	5/8	15.9	1 1/16-14	1 1/4	31.8	1 1/4	31.8	1 1/8		1.80	45.7	2.94	74.7	Y

# SAE 45° J512 Flare

Female | 45° Elbow | Swivel

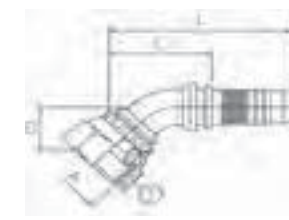

Descriptive #	Product #	SAP #	Hose Size ID		Thread Size	Hex-1 Wrench Size		Hex-2 Wrench Size		Socket (S) Wrench Size		Drop (D)		Length (L)		DUT		
			in.	mm		in.	mm	in.	mm	in.	mm	in.	mm					
UT-SFFX45-0606	38777-0606	20419748	5/16	7.9	5/8-18	1/2	12.7	3/4	19.1	3/4		0.41	10.4	1.48	37.6	2.33	59.2	Y
UT-SFFX45-1212	38777-1212	20419752	5/8	15.9	1 1/16-14	7/8	22.2	1 1/4	31.8	1 1/8		0.78	19.8	2.49	63.2	3.63	92.2	Y

## SAE 45° J512 Flare

Female | 90° Elbow | Swivel

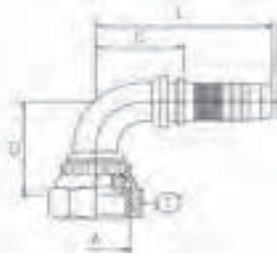

Descriptive #	Product #	SAP #	Hose Size ID		Thread Size	Hex-1 Wrench Size		Hex-2 Wrench Size		Socket (S) Wrench Size	Drop (D)		Cut-Off (C)		Length (L)		DUT
			in.	mm		in.	mm	in.	mm	in.	mm	in.	mm	in.	mm		
UT-SFFX90-0606	38780-0606	20419539	5/16	7.9	5/8-18	1/2	12.7	3/4	19.1	3/4	0.84	21.3	1.36	34.5	2.21	56.1	Y
UT-SFFX90-1212	38780-1212	20419536	5/8	15.9	1 1/16-14	7/8	22.2	1 1/4	31.8	1 1/4	1.81	46.0	2.44	62.0	3.58	90.9	Y

## SAE 45° Inverted Flare

Male | Swivel



Descriptive #	Product #	SAP #	Hose Size ID		Thread Size	Hex-1 Wrench Size		Hex-2 Wrench Size		Socket Hex (S) Wrench Size	Cut-Off (C)		Length (L)		DUT
			in.	mm		in.	mm	in.	mm	in.	mm	in.	mm		
UT-SIMX-0404	38800-0404	20419716	3/16	4.8	7/16-24	1/2	12.7	7/16	11.1	9/16	1.33	33.8	2.05	52.1	Y
UT-SIMX-0505	38800-0505	20419717	1/4	6.4	1/2-20	1/2	12.7	1/2	12.7	5/8	1.45	36.8	2.26	57.4	Y
UT-SIMX-0605	38800-0605	20419718	5/16	7.9	1/2-20	1/2	12.7	1/2	12.7	3/4	1.54	39.1	2.39	60.7	Y
UT-SIMX-0606	38800-0606	20419719	5/16	7.9	5/8-18	1/2	12.7	5/8	15.9	3/4	1.86	47.2	2.71	68.8	Y
UT-SIMX-0808	38800-0808	20419740	13/32	10.3	3/4-18	1 1/16	17.5	3/4	19.1	7/8	2.24	56.9	3.24	82.3	Y

## SAE 45° Inverted Flare

Male | 45° Elbow | Swivel

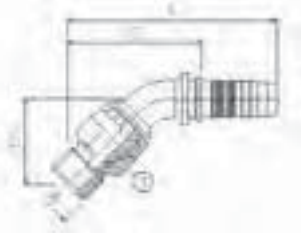

Descriptive #	Product #	SAP #	Hose Size ID		Thread Size	Hex-1 Wrench Size		Hex-2 Wrench Size		Socket (S) Wrench Size	Drop (D)		Length (L)		DUT		
			in.	mm		in.	mm	in.	mm	in.	mm	in.	mm				
UT-SIMX45-0606	38810-0606	20419640	5/16	7.9	5/8-18	1/2	12.7	5/8	15.9	3/4	0.84	21.3	2.94	74.7	3.79	96.3	Y
UT-SIMX45-0808	38810-0808	20419741	13/32	10.3	3/4-18	1 1/16	17.5	3/4	19.1	7/8	1.09	27.7	3.24	82.3	4.24	107.7	Y

# SAE 45° Inverted Flare

Male | 90° Elbow | Swivel



Descriptive #	Product #	SAP #	Hose Size ID		Thread Size	Hex-1 Wrench Size		Hex-2 Wrench Size		Socket (S) Wrench Size	Drop (D)		Cut-Off (C)		Length (L)		DUT
			in.	mm		in.	mm	in.	mm	in.	in.	mm	in.	mm	in.	mm	
UT-SIMX90-0404	38815-0404	20419641	3/16	4.8	7/16-24	1/2	12.7	7/16	11.1	9/16	1.25	31.8	1.33	33.8	2.05	52.1	Y
UT-SIMX90-0505	38815-0505	20419642	1/4	6.4	1/2-20	1/2	12.7	1/2	12.7	5/8	1.50	38.1	1.46	37.1	2.25	57.2	Y
UT-SIMX90-0605	38815-0605	20419643	5/16	7.9	1/2-20	1/2	12.7	1/2	12.7	3/4	1.50	38.1	1.54	39.1	2.39	60.7	Y
UT-SIMX90-0606	38815-0606	20419644	5/16	7.9	5/8-18	1/2	12.7	5/8	15.9	3/4	1.63	41.4	1.86	47.2	2.71	68.8	Y
UT-SIMX90-0808	38815-0808	20419714	13/32	10.3	3/4-18	11/16	17.5	3/4	19.1	7/8	2.00	50.8	2.24	56.9	3.24	82.3	Y

# NPTF

Male

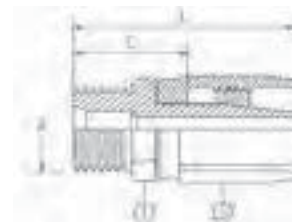

Descriptive #	Product #	SAP #	Hose Size ID		Thread Size	Hex-1 Wrench Size		Socket Hex (S) Wrench Size	Cut-Off (C)		Length (L)		DUT
			in.	mm		in.	mm	in.	in.	mm	in.	mm	
UT-NPM-0402	38615-0402	20419753	3/16	4.8	1/8-27	1/2	12.7	9/16	0.81	20.6	1.53	38.9	Y
UT-NPM-0404	38615-0404	20419754	3/16	4.8	1/4-18	9/16	14.3	9/16	1.03	26.2	1.75	44.5	Y
UT-NPM-0504	38615-0504	20419755	1/4	6.4	1/4-18	9/16	14.3	5/8	0.96	24.4	1.76	44.7	Y
UT-NPM-0604	38615-0604	20419756	5/16	7.9	1/4-18	9/16	14.3	3/4	1.00	25.4	1.85	47.0	Y
UT-NPM-0606	38615-0606	20419757	5/16	7.9	3/8-18	11/16	17.5	3/4	1.04	26.4	1.89	48.0	Y
UT-NPM-0806	38615-0806	20419758	13/32	10.3	3/8-18	11/16	17.5	7/8	1.19	30.2	2.19	55.6	Y
UT-NPM-0808	38615-0808	20419759	13/32	10.3	1/2-14	7/8	22.2	7/8	1.29	32.8	2.29	58.2	Y
UT-NPM-1008	38615-1008	20419770	1/2	12.7	1/2-14	7/8	22.2	1	1.31	33.3	2.38	60.5	Y
UT-NPM-1212	38615-1212	20419771	5/8	15.9	3/4-14	1 1/16	27.0	1 1/8	1.44	36.6	2.59	65.8	Y
UT-NPM-1612	38615-1612	20419773	7/8	22.2	3/4-14	1 1/16	27.0	1 1/8	1.43	36.3	2.49	63.2	Y
UT-NPM-1616	38615-1616	20419772	7/8	22.2	1-11 1/2	1 3/8	34.9	1 3/8	1.74	44.2	2.80	71.1	Y
UT-NPM-2020	38615-2020	20419774	1 1/8	28.6	1 1/4-11	1 3/4	44.5	1 3/4	1.80	45.7	2.92	74.2	Y

# SAE J514 Flareless Tube Fittings

Male

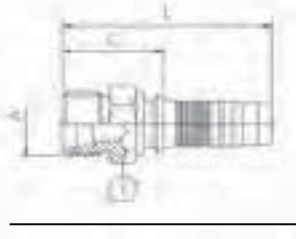

Descriptive #	Product #	SAP #	Hose Size ID		Thread Size	Hex-1 Wrench Size		Hex-2 Wrench Size		Socket Hex (S) Wrench Size		Cut-Off (C)		Length (L)		DUT
			in.	mm		in.	mm	in.	mm	in.	mm	in.	mm	in.	mm	
UT-FTM-0404	38360-0404	20419775	3/16	4.8	7/16-20	1/2	12.7	9/16	14.3	9/16	0.96	24.5	1.68	42.7	Y	
UT-FTM-0505	38360-0505	20419777	1/4	6.4	1/2-20	9/16	14.3	5/8	15.9	5/8	0.92	23.4	1.72	43.7	Y	
UT-FTM-0604	38360-0604	20419778	5/16	7.9	7/16-20	9/16	14.3	9/16	14.3	3/4	1.01	25.7	2.12	53.8	Y	
UT-FTM-0606	38360-0606	20419779	5/16	7.9	5/8-18	5/8	15.9	11/16	17.5	3/4	1.03	26.2	1.87	47.6	Y	
UT-FTM-0808	38360-0808	20419780	13/32	10.3	3/4-16	13/16	20.6	7/8	22.2	7/8	1.15	29.2	2.15	54.6	Y	
UT-FTM-1010	38360-1010	20419781	1/2	12.7	7/8-14	15/16	23.8	1	25.4	1	1.27	32.3	2.34	59.6	Y	

\* All Fittings come with Nut and Sleeve

# Flange Engine Oil Connection (Two Bolt)

90° Elbow

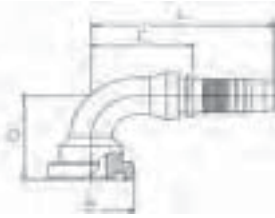

Descriptive #	Product #	SAP #	Hose Size ID		Thread Size	Hex-1 Wrench Size		Hex-2 Wrench Size		Socket (S) Wrench Size		Drop (D)		Cut-Off (C)		Length (L)		DUT
			in.	mm		in.	mm	in.	mm	in.	mm	in.	mm	in.	mm	in.	mm	
UT-FL90EOC-2020	38351-2020	20419745	1 1/8	28.6	1/4	1 1/16	39.7	1 1/8	2.50	63.5	3.82	97.0	4.95	125.7	Y	52.1	Y	

UT-FL90EOC-2020 includes engine connection flange clamp plate

# PTT 30°

Female | Swivel

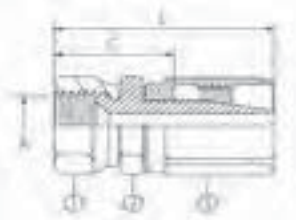

Descriptive #	Product #	SAP #	Hose Size ID		Thread Size	Hex-1 Wrench Size		Hex-2 Wrench Size		Socket Hex (S) Wrench Size		Cut-Off (C)		Length (L)		DUT
			in.	mm		in.	mm	in.	mm	in.	mm	in.	mm			
UT-PTTFX-1616	38745-1616	20419805	7/8	22.2	1 1/16-14	1 1/2	38.1	1 1/2	38.1	1 1/2	1.68	42.7	2.74	69.6	Y	

## How to Use the Fitting Tables

This section lists ALL fittings that are compatible with the following hoses:

Hose Family	Hose Description
NSFX	SAFLEX® (Non-Conductive)
SHR	Slim Hole Rotary
HOT OILER	Hot Oiler
SGUN	Grease Gun
SHJ	Jack Hose
IG	Insta-Grip™ 300 (Non-Conductive)
IGHT	Insta-Grip™ HT 300 Push-On (High Temp)
IGTC	Insta-Grip™ TC (Textile Cover)
FXG	FLEXA-Grip™ (Non-Conductive, Abrasion Cover)

The Continental ContiTech hose compatible with each fitting style in this section is shown at the right, in the "Fitting Style" heading. The fitting styles are different for each hose family.

The fittings listed in each "Fitting Style" section are the only approved fittings for the hose shown.

**Be sure to use only those fittings shown for the hose families listed in the heading.**

## Fitting Description

Compatible Hose Family



Descriptive #	Product #	Hose Size ID		Thread Size (A)	Hex-1 Wrench Size		Cut-Off (C)		Length (L)	
		in.	mm		in.	mm	in.	mm	in.	mm
B2-NPM-0402	14615-0402	1/4	6.40	1/8-27	9/16	14	0.88	22.30	1.85	47.10
B2-NPM-0404	14615-0404	1/4	6.40	1/4-18	11/16	17	1.04	26.30	2.01	51.10
B2-NPM-0406	14615-0406	1/4	6.40	3/8-18	13/16	19	1.04	26.30	2.01	51.10
B2-NPM-0408	14615-0408	1/4	6.40	1/2-14	7/8	22	1.31	33.30	2.29	58.10

“SF” NSFJ Hose Fittings (for use with SAFLEX® Hose)

## JIC 37° Flare (SAE J514)

Female | Swivel

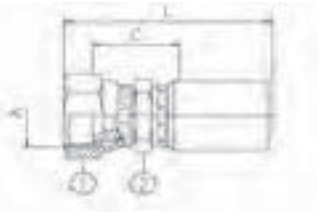

Descriptive #	Product #	SAP #	Hose Size ID		Thread Size (A)	Hex-1 Wrench Size		Cut-Off (C)		Length (L)	
			in.	mm		in.	mm	in.	mm	in.	mm
SF-JCFX-0606	26400-0606	20766318	3/8	9.5	9/16-18	1/16	27	Contact Continental ContiTech			

## NPTF

Male

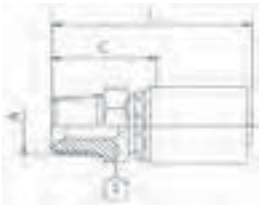

Descriptive #	Product #	SAP #	Hose Size ID		Thread Size (A)	Hex-1 Wrench Size		Cut-Off (C)		Length (L)	
			in.	mm		in.	mm	in.	mm	in.	mm
SF-NPM-0606	26615-0606	20285743	3/8	9.5	3/8-18	3/4	19	1.24	31.5	2.58	65.5
SF-NPM-0608	26615-0608	20413965	3/8	9.5	1/2-14	7/8	22	1.59	40.5	2.86	72.6
SF-NPM-0808	26615-0808	20352115	1/2	12.7	1/2-14	7/8	22	1.57	40.0	3.04	77.2

## NPTF

Male | Swivel

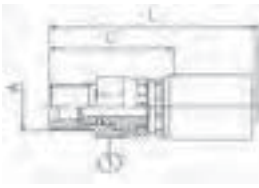

Descriptive #	Product #	SAP #	Hose Size ID		Thread Size (A)	Hex-1 Wrench Size		Cut-Off (C)		Length (L)	
			in.	mm		in.	mm	in.	mm	in.	mm
SF-NPMX-0606	26645-0606	20347559	3/8	9.5	3/8-18	3/4	19	1.83	46.6	3.15	79.9
SF-NPMX-0808	26645-0808	20414341	1/2	12.7	1/2-14	7/8	22	1.76	44.6	3.26	82.8



“SF” NSFX Hose Fittings (for use with SAFLEX® Hose)

O-Ring Boss

Male

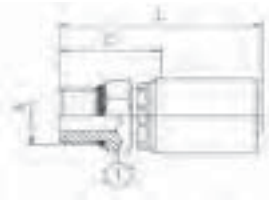

Descriptive #	Product #	SAP #	Hose Size ID		Thread Size (A)	Hex-1 Wrench Size		Cut-Off (C)		Length (L)	
			in.	mm		in.	mm	in.	mm	in.	mm
SF-OBM-0608	26670-0608	20766320	3/8	9.5	3/4-16	7/8	22	Contact Continental ContiTech			

O-Ring Boss

Male | Swivel



Descriptive #	Product #	SAP #	Hose Size ID		Thread Size (A)	Hex-1 Wrench Size		Cut-Off (C)		Length (L)	
			in.	mm		in.	mm	in.	mm	in.	mm
SF-OBMX-0606	26680-0606	20766322	3/8	9.5	9/16-18	7/8	22	Contact Continental ContiTech			
SF-OBMX-0608	26680-0608	20352114	3/8	9.5	3/4-16	7/8	22	1.73	44.0	3.00	76.3

SHR Hose Fittings (for use with Prospector™ Slim Hole Rotary Hose)

NPT

Male API

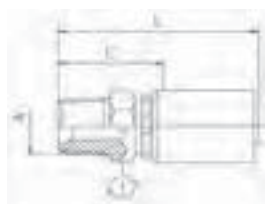

S=Skive  
NS=Non-Skive  
DG=Dual-Grip™

Descriptive #	Product #	SAP #	Hose Size ID		Thread Size (A)	Hex-1 Wrench Size		Cut-Off (C)		Length (L)		Skive Type	SHR 3000	SHR 3650	SHR 5000
			in.	mm		in.	mm	in.	mm	in.	mm				
S6-NPM-API-1616*	30617-1616	20466169	1	25.4	1-11½	17/16	36	2.66	67.5	5.18	131.5	NS			Y
S6-NPM-API-2020*	30617-2020	20466171	1¼	31.8	1¼-11½	1¾/16	46	2.94	74.6	6.70	170.1	NS			Y
S6-NPM-API-2424*	30617-2424	20466174	1½	38.1	1½-11½	2	50	3.27	83.0	6.54	166.0	NS			Y
S4H-NPM-API-3232		20762944	2	50.8	2-11½	Contact Continental ContiTech					NS	Y			
S6-NPM-API-3232*	30618-3232	20679658	2	50.8	2-11½	2¼/16	70	4.20	106.8	8.31	211.1	NS			Y
DG-NPM-API-3232**	16630-3232	20466175	2	50.8	2-11½	2¾/16	65	3.76	95.5	7.58	192.5	DG	DGF1-32	DGF1-32	DGF2-32
SG-NPM-API-3232***	29630-3232	20833300	2	50.8	2-11½	2¼/16	70	4.35	110.5	7.90	200.5	NS		Y	

\*Can be used with SR13  
\*\*Can be used with S4SH and SR13  
\*\*\*Can be used with S4SH-32

Continued on next page

SHR Hose Fittings (for use with Prospector™ Slim Hole Rotary Hose) Continued

Fig. 1502

Fig. 1502 Hammer Union

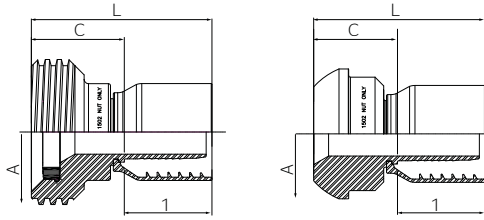

Descriptive #	Product #	SAP #	Hose Size ID		Thread Size (A)	Hex-1 Wrench Size		Cut-Off (C)		Length (L)		Skive Type	SHR 3000	SHR 3650	SHR 5000
			in.	mm		in.	mm	in.	mm	in.	mm				
S6-IHUF1502-3232*	30390-3232	20806362	2	50.8	ACME-2G, 3 TPI			2.59	65.8	6.52	165.5	NS			Y
S6-IHUM1502-3232*	30395-3232	20806363	2	50.8	ACME-2G, 3 TPI			2.62	66.4	6.55	166.3	NS			Y
SG-IHUF1502-3232**	29390-3232	20833304	2	50.8	ACME-2G, 3 TPI			2.74	69.5	6.28	159.5	NS	Y		
SG-IHUM1502-3232**	29395-3232	20833305	2	50.8	ACME-2G, 3 TPI			2.77	70.2	6.31	160.2	NS	Y		

\*Can be used with SR13  
 \*\*Can be used with S4SH

Hot Oiler Hose Fittings (for use with Prospector™ Hot Oiler Hose)

NPT - API

Fig. 1502 Hammer Union

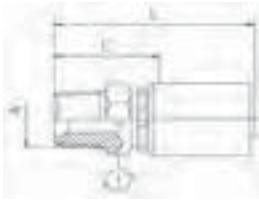

Descriptive #	Product #	SAP #	Hose Size ID		Thread Size (A)	Hex-1 Wrench Size		Cut-Off (C)		Length (L)		Skive Type	Hot Oiler
			in.	mm		in.	mm	in.	mm	in.	mm		
S4-NPMAPI-2424	28617-2424	20636530	1½	38.1	2-11½	2	51	3.072	78.0	5.4	137.2	NS	Y

Fig. 1502

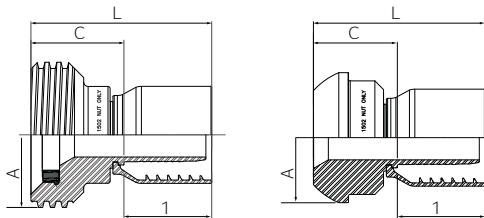

Descriptive #	Product #	SAP #	Hose Size ID		Thread Size (A)	Hex-1 Wrench Size		Cut-Off (C)		Length (L)		Skive Type	Hot Oiler
			in.	mm		in.	mm	in.	mm	in.	mm		
S4-IHUF1502-2432	28390-2432	20815350	1½	38.1	ACME-2G, 3 TPI			2.64	67.1	4.81	122.2	NS	Y
S4-IHUM1502-2432	28395-2432	20815351	1½	38.1	ACME-2G, 3 TPI			2.38	60.5	4.88	123.9	NS	Y

“GG” SGUN Hose Fittings (for use with Grease Gun Hose)

**NPTF**

Male

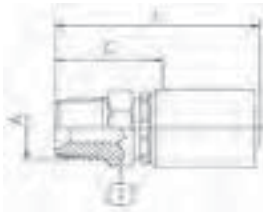

Descriptive #	Product #	SAP #	Hose Size ID		Thread Size (A)	Hex-1 Wrench Size		Cut-Off (C)		Length (L)	
			in.	mm		in.	mm	in.	mm	in.	mm
GG-NPM-0302	20615-0302	20288023	3/16	4.8	1/8-27	5/8	15	0.38	9.7	1.38	35.1

“B2” SHJ Hose Fittings (for use with Jack Hose)

**NPTF**

Male

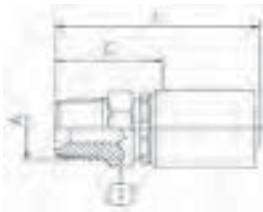

Descriptive #	Product #	SAP #	Hose Size ID		Thread Size (A)	Hex-1 Wrench Size		Cut-Off Length (C)		Length (L)	
			in.	mm		in.	mm	in.	mm	in.	mm
B2-NPM-0402	14615-0402	20242110	1/4	6.4	1/8-27	9/16	14	0.88	22.3	1.85	47.1
B2-NPM-0404	14615-0404	20242111	1/4	6.4	1/4-18	11/16	17	1.06	27.0	2.15	54.6
B2-NPM-0404S	14615-0404S	20286649	1/4	6.4	1/4-18	11/16	17	1.06	27.0	2.15	54.6
B2-NPM-0406	14615-0406	20242109	1/4	6.4	3/8-18	3/4	19	1.04	26.3	2.01	51.1
B2-NPM-0408	14615-0408	20242115	1/4	6.4	1/2-14	7/8	22	1.31	33.3	2.29	58.1
B2-NPM-0604	14615-0604	20242067	3/8	9.5	1/4-18	11/16	17	1.04	26.3	2.09	53.0
B2-NPM-0606	14615-0606	20242069	3/8	9.5	3/8-18	3/4	19	1.04	26.4	2.09	53.1
B2-NPM-0606S	14615-0606S	20286830	3/8	9.5	3/8-18			1.10	27.9	2.05	52.0
B2-NPM-0608	14615-0608	20242079	3/8	9.5	1/2-14	7/8	22	1.27	32.3	2.32	59.0

"PB" Push-On Brass Fittings (for use with Insta-Grip™ 300, Insta-Grip™ HT 300, Insta-Grip™ TC & FLEXA-Grip™ Hose)

## Hose Mender

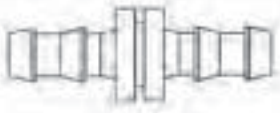

Descriptive #	Product #	SAP #	Hose Size ID		Thread Size (A)	Hex-1 Wrench Size		Cut-Off Length (C)		Overall Length (L)	
			in.	mm		in.	mm	in.	mm	in.	mm
PB-HM-0404	22380-0404	20282715	1/4	6.4				0.06	1.5	1.80	45.7
PB-HM-0505	22380-0505	20282716	5/16	7.9				0.06	1.5	1.80	45.7
PB-HM-0606	22380-0606	20282717	3/8	9.5				0.06	1.5	2.00	50.8
PB-HM-0808	22380-0808	20282718	1/2	12.7				0.06	1.5	2.00	50.8
PB-HM-1010	22380-1010	20283080	5/8	15.9				0.13	3.3	3.03	77.0
PB-HM-1212	22380-1212	20283081	3/4	19.0				0.13	3.3	3.03	77.0

## JIC 37° Flare

Female | Swivel



Descriptive #	Product #	SAP #	Hose Size ID		Thread Size (A)	Hex-1 Wrench Size		Cut-Off Length (C)		Overall Length (L)	
			in.	mm		in.	mm	in.	mm	in.	mm
PB-JCFX-0404	22400-0404	20282736	1/4	6.4	7/16-20	9/16	14	0.57	14.5	1.54	39.1
PB-JCFX-0405	22400-0405	20283092	1/4	6.4	1/2-20	5/8	16	0.60	15.1	1.57	39.9
PB-JCFX-0406	22400-0406	20282738	1/4	6.4	9/16-18	3/4	19	0.62	15.8	1.60	40.6
PB-JCFX-0605	22400-0605	20282739	3/8	9.5	1/2-20	5/8	16	0.60	15.1	1.67	42.4
PB-JCFX-0606	22400-0606	20282740	3/8	9.5	9/16-18	3/4	19	0.62	15.8	1.70	43.2
PB-JCFX-0608	22400-0608	20282741	3/8	9.5	3/4-16	7/8	22	0.75	19.0	1.85	47.0
PB-JCFX-0808	22400-0808	20282742	1/2	12.7	3/4-16	7/8	22	0.69	17.5	1.78	45.2
PB-JCFX-0810	22400-0810	20283093	1/2	12.7	7/8-14	1	25	0.74	18.8	1.84	46.7
PB-JCFX-1008	22400-1008	20283094	5/8	15.9	3/4-16	7/8	22	0.70	17.7	2.27	57.7
PB-JCFX-1010	22400-1010	20282745	5/8	15.9	7/8-14	1	25	0.75	19.0	2.33	59.2
PB-JCFX-1212	22400-1212	20283095	3/4	19.0	1 1/16-12	1 1/4	32	0.81	20.5	2.40	61.0
PB-JCFX-1616	22400-1616	20466036	1	25.4	1 1/16-12	1 1/2	38	1.13	28.7	2.57	65.3

## JIC 37° Flare

Female 90° Elbow | Swivel

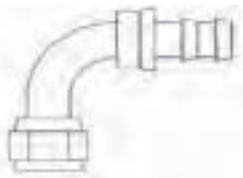

Descriptive #	Product #	SAP #	Hose Size ID		Thread Size (A)	Hex-1 Wrench Size		Cut-Off Length (C)		Drop Length (L)	
			in.	mm		in.	mm	in.	mm	in.	mm
PB-JCFX90-0606	22425-0606	20450811	3/8	9.5	9/16-18	3/4	19	0.87	22.0	1.02	26.0

“PB” Push-On Brass Fittings (for use with Insta-Grip™ 300, Insta-Grip™ HT 300, Insta-Grip™ TC & FLEXA-Grip™ Hose)  
Continued

**JIC 37° Flare**

Male

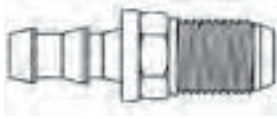

Descriptive #	Product #	SAP #	Hose Size ID		Thread Size (A)	Hex-1 Wrench Size		Cut-Off Length (C)		Overall Length (L)	
			in.	mm		in.	mm	in.	mm	in.	mm
PB-JCM-0404	22450-0404	20282768	1/4	6.4	7/16-20	1/2	13	0.70	17.8	1.57	39.9
PB-JCM-0406	22450-0406	20289525	1/4	6.4	9/16-18	5/8	16	0.77	19.6	1.64	41.7
PB-JCM-0606	22450-0606	20282769	3/8	9.5	9/16-18	5/8	16	0.81	20.6	1.78	45.2
PB-JCM-0808	22450-0808	20282771	1/2	12.7	3/4-16	3/4	19	1.00	25.4	1.97	50.0

**NPTF**

Female

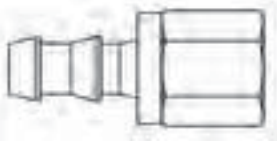

Descriptive #	Product #	SAP #	Hose Size ID		Thread Size (A)	Hex-1 Wrench Size		Cut-Off Length (C)		Overall Length (L)	
			in.	mm		in.	mm	in.	mm	in.	mm
PB-NPF-0402	22600-0402	20289527	1/4	6.4	1/8-27	1/2	13	0.41	10.4	1.35	34.3
PB-NPF-0404	22600-0404	20282772	1/4	6.4	1/4-18	5/8	16	0.54	13.8	1.51	38.4
PB-NPF-0504	22600-0504	20289528	5/16	7.9	1/4-18	5/8	16	0.54	13.8	1.51	38.4
PB-NPF-0604	22600-0604	20283105	3/8	9.5	1/4-18	5/8	16	0.54	13.8	1.61	40.9
PB-NPF-0606	22600-0606	20282774	3/8	9.5	3/8-18	3/4	19	0.56	14.3	1.63	41.4
PB-NPF-0806	22600-0806	20282775	1/2	12.7	3/8-18	3/4	19	0.56	14.3	1.63	41.4
PB-NPF-0808	22600-0808	20282776	1/2	12.7	1/2-14	15/16	24	0.68	17.3	1.77	45.0

**NPTF**

Male

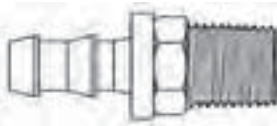

Descriptive #	Product #	SAP #	Hose Size ID		Thread Size (A)	Hex-1 Wrench Size		Cut-Off Length (C)		Overall Length (L)	
			in.	mm		in.	mm	in.	mm	in.	mm
PB-NPM-0402	22615-0402	20283096	1/4	6.4	1/8-27	1/2	13	0.56	14.2	1.43	36.3
PB-NPM-0404	22615-0404	20282748	1/4	6.4	1/4-18	9/16	14	0.79	20.1	1.66	42.2
PB-NPM-0406	22615-0406	20282749	1/4	6.4	3/8-18	11/16	17	0.79	20.1	1.66	42.2
PB-NPM-0504	22615-0504	20289529	5/16	7.9	1/4-18	9/16	14	0.79	20.1	1.66	42.2
PB-NPM-0602	22615-0602	20282750	3/8	9.5	1/8-27	1/2	13	0.56	14.2	1.53	38.9
PB-NPM-0604	22615-0604	20283097	3/8	9.5	1/4-18	9/16	14	0.79	20.1	1.76	44.7
PB-NPM-0606	22615-0606	20282752	3/8	9.5	3/8-18	11/16	17	0.79	20.1	1.76	44.7
PB-NPM-0608	22615-0608	20282753	3/8	9.5	1/2-14	7/8	22	1.00	25.4	1.97	50.0

Continued on next page

**“PB” Push-On Brass Fittings (for use with Insta-Grip™ 300, Insta-Grip™ HT 300, Insta-Grip™ TC & FLEXA-Grip™ Hose)**  
Continued

## NPTF

Male Continued

Descriptive #	Product #	SAP #	Hose Size ID		Thread Size (A)	Hex-1 Wrench Size		Cut-Off Length (C)		Overall Length (L)	
			in.	mm		in.	mm	in.	mm	in.	mm
PB-NPM-0804	22615-0804	20283098	1/2	12.7	1/4-18	11/16	17	0.79	20.1	1.76	44.7
PB-NPM-0806	22615-0806	20282755	1/2	12.7	3/8-18	11/16	17	0.79	20.1	1.76	44.7
PB-NPM-0808	22615-0808	20282756	1/2	12.7	1/2-14	7/8	22	1.00	25.4	1.97	50.0
PB-NPM-0812	22615-0812	20283099	1/2	12.7	3/4-14	1 1/16	27	1.00	25.4	1.97	50.0
PB-NPM-1006	22615-1006	20289540	5/8	15.9	3/8-18	3/4	19	0.89	22.6	2.34	59.4
PB-NPM-1008	22615-1008	20283100	5/8	15.9	1/2-14	7/8	22	1.00	25.4	2.45	62.2
PB-NPM-1012	22615-1012	20282759	5/8	15.9	3/4-14	1 1/16	27	1.00	25.4	2.45	62.2
PB-NPM-1208	22615-1208	20283101	3/4	19.0	1/2-14	7/8	22	1.00	25.4	2.45	62.2
PB-NPM-1212	22615-1212	20283102	3/4	19.0	3/4-14	1 1/16	27	1.00	25.4	2.45	62.2

## NPTF

Male | 90° Elbow

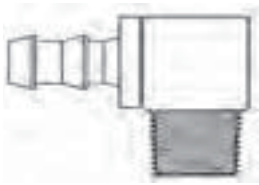

Descriptive #	Product #	SAP #	Hose Size ID		Thread Size (A)	Hex-1 Wrench Size		Cut-Off Length (C)		Drop Length (L)	
			in.	mm		in.	mm	in.	mm	in.	mm
PB-NPM90-0402	22625-0402	20283106	1/4	6.4	1/8-27			0.08	2.1	0.75	19.1
PB-NPM90-0404	22625-0404	20283107	1/4	6.4	1/4-18			0.13	3.2	0.95	24.1
PB-NPM90-0602	22625-0602	20289541	3/8	9.5	1/8-27			0.11	2.7	0.75	19.1
PB-NPM90-0604	22625-0604	20282779	3/8	9.5	1/4-18			0.12	3.1	0.90	22.9
PB-NPM90-0606	22625-0606	20282780	3/8	9.5	3/8-18			0.17	4.2	0.87	22.1
PB-NPM90-0806	22625-0806	20282782	1/2	12.7	3/8-18			0.40	10.1	1.19	30.2
PB-NPM90-0808	22625-0808	20283109	1/2	12.7	1/2-14			0.40	10.1	1.19	30.2
PB-NPM90-1008	22625-1008	20289542	5/8	15.9	1/2-14			0.40	10.1	1.19	30.2
PB-NPM90-1012	22625-1012	20289543	5/8	15.9	3/4-14			0.47	11.8	1.28	32.5
PB-NPM90-1212	22625-1212	20282784	3/4	19.0	3/4-14			0.47	11.8	1.28	32.5

“PB” Push-On Brass Fittings (for use with Insta-Grip™ 300, Insta-Grip™ HT 300, Insta-Grip™ TC & FLEXA-Grip™ Hose)  
Continued

**NPTF**

Male | Swivel



Descriptive #	Product #	SAP #	Hose Size ID		Thread Size (A)	Hex-1 Wrench Size		Cut-Off Length (C)		Overall Length (L)	
			in.	mm		in.	mm	in.	mm	in.	mm
PB-NPMX-0404	22645-0404	20282762	1/4	6.4	1/4-18	9/16	14	1.15	29.2	2.02	51.3
PB-NPMX-0604	22645-0604	20283103	3/8	9.5	1/4-18	9/16	14	1.15	29.2	2.12	53.9
PB-NPMX-0606	22645-0606	20282764	3/8	9.5	3/8-18	11/16	17	1.15	29.2	2.12	53.9
PB-NPMX-0806	22645-0806	20282765	1/2	12.7	3/8-18	11/16	17	1.15	29.2	2.12	53.9
PB-NPMX-0808	22645-0808	20282766	1/2	12.7	1/2-14	7/8	22	1.36	34.5	2.33	59.2
PB-NPMX-1212	22645-1212	20283104	3/4	19.0	3/4-14	1 1/16	27	1.35	34.3	2.80	71.1

**SAE 45° Flare**

Female | Swivel



Descriptive #	Product #	SAP #	Hose Size ID		Thread Size (A)	Hex-1 Wrench Size		Cut-Off Length (C)		Overall Length (L)	
			in.	mm		in.	mm	in.	mm	in.	mm
PB-SFFX-0405	22775-0405	20289551	1/4	6.4	1/2-20	5/8	16	0.60	15.1	1.57	39.9
PB-SFFX-0406	22775-0406	20289552	1/4	6.4	5/8-18	3/4	19	0.65	16.4	1.63	41.4
PB-SFFX-0506	22775-0506	20289553	5/16	7.9	5/8-18	3/4	19	0.65	16.4	1.63	41.4
PB-SFFX-0606	22775-0606	20282722	3/8	9.5	5/8-18	3/4	19	0.65	16.4	1.73	43.9
PB-SFFX-0608	22775-0608	20289554	3/8	9.5	3/4-16	7/8	22	0.75	19.0	1.85	47.0
PB-SFFX-0806	22775-0806	20289555	1/2	12.7	5/8-18	7/8	22	0.81	20.5	1.92	48.8
PB-SFFX-0808	22775-0808	20283083	1/2	12.7	3/4-16	7/8	22	0.64	16.2	1.72	43.7
PB-SFFX-0810	22775-0810	20289556	1/2	12.7	7/8-14	1	25	0.74	18.8	1.84	46.7
PB-SFFX-1008	22775-1008	20289557	5/8	15.9	3/4-16	7/8	22	0.70	17.7	2.27	57.7
PB-SFFX-1010	22775-1010	20283084	5/8	15.9	7/8-14	1	25	0.75	19.0	2.33	59.2
PB-SFFX-1212	22775-1212	20282725	3/4	19.0	1 1/16-14	1 1/4	32	0.82	20.9	2.42	61.5

**SAE 45° Flare**

Male

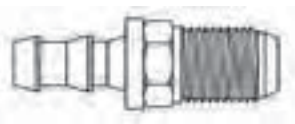

Descriptive #	Product #	SAP #	Hose Size ID		Thread Size (A)	Hex-1 Wrench Size		Cut-Off Length (C)		Overall Length (L)	
			in.	mm		in.	mm	in.	mm	in.	mm
PB-SFM-0606	22785-0606	20282770	3/8	9.5	5/8-18	5/8	16	0.86	21.8	1.83	46.5

**“PB” Push-On Brass Fittings (for use with Insta-Grip™ 300, Insta-Grip™ HT 300, Insta-Grip™ TC & FLEXA-Grip™ Hose)**  
Continued

## SAE 45° Inverted Flare

Female

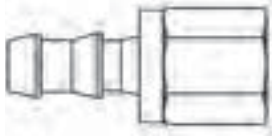

Descriptive #	Product #	SAP #	Hose Size ID		Thread Size (A)	Hex-1 Wrench Size		Cut-Off Length (C)		Overall Length (L)	
			in.	mm		in.	mm	in.	mm	in.	mm
PB-SIF-0403	22790-0403	20289544	1/4	6.4	3/8-24	1/2	13	0.25	6.4	1.12	28.5
PB-SIF-0404	22790-0404	20283090	1/4	6.4	7/16-24	5/8	16	0.23	5.8	1.14	29.0
PB-SIF-0405	22790-0405	20289545	1/4	6.4	1/2-20	9/16	14	0.26	6.7	1.18	30.0
PB-SIF-0605	22790-0605	20289546	3/8	9.5	1/2-20	5/8	16	0.30	7.6	1.32	33.5
PB-SIF-0606	22790-0606	20282734	3/8	9.5	5/8-18	3/4	19	0.32	8.2	1.35	34.3
PB-SIF-0808	22790-0808	20283091	1/2	12.7	3/4-18	7/8	22	0.65	16.4	1.73	43.9

## SAE 45° Inverted Flare

Male

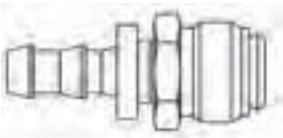

Descriptive #	Product #	SAP #	Hose Size ID		Thread Size (A)	Hex-1 Wrench Size		Cut-Off Length (C)		Overall Length (L)	
			in.	mm		in.	mm	in.	mm	in.	mm
PB-SIM-0403	22795-0403	20289548	1/4	6.4	3/8-24	7/16	11	0.69	17.5	1.56	39.6
PB-SIM-0404	22795-0404	20283085	1/4	6.4	7/16-24	7/16	11	0.69	17.5	1.56	39.6
PB-SIM-0405	22795-0405	20283086	1/4	6.4	1/2-20	1/2	13	0.75	19.1	1.62	41.2
PB-SIM-0505	22795-0505	20283087	5/16	7.9	1/2-20	1/2	13	0.75	19.1	1.62	41.2
PB-SIM-0506	22795-0506	20283088	5/16	7.9	5/8-18	5/8	16	0.76	19.3	1.63	41.4
PB-SIM-0605	22795-0605	20282730	3/8	9.5	1/2-20	1/2	13	0.75	19.1	1.72	43.7
PB-SIM-0606	22795-0606	20282731	3/8	9.5	5/8-18	5/8	16	0.79	20.1	1.76	44.7
PB-SIM-0808	22795-0808	20283089	1/2	12.7	3/4-18	3/4	19	0.87	22.1	1.84	46.7
PB-SIM-1010	22795-1010	20289550	5/8	15.9	7/8-18	1	25	0.90	22.9	2.35	59.7



# A/C Fitting Nomenclature

Cool Clip® Fitting Style	Family	Fitting Family Description	Gender	Swivel	Valve (V)	Attribute
CB12VS	CB	Compressor Pad Block			R12	S=Single
CB12VSR	CB				R12	SR=Single Reversed
COTF	COT	Compressor O-Ring Tube	F	Yes		
COTF134V	COT		F	Yes	R134a	
FTBO	FT					BO=Brace On
FTM	FT	Flareless Tube	M			
FTMM	FT		M			M=Metric
FTN	FT					N=Nut
FTS	FT					S=Sleeve
FTSM	FT					S=Sleeve, M=Metric
FSLF	FSL		Ford Spring Lock	F		
FSLM	FSL	M				
HM	HM	Hose Mender				
HM12V	HM				R12	
HM134V	HM				R134a	
HMSG	HM					SG=Sight Glass
HMT	HM					T=Tee
ILOTORA	ILOT	Inline Orifice Tube				ORA=Orange
ILOTRED	ILOT					RED=Red
ILOTBLU	ILOT					BLU=Blue
ILOTBLK	ILOT					BLK=Black
ILOTWHI	ILOT					WHI=White
OFFX	OF	O-Ring Face Seal (SAE J1453 ORS/ORFS)	F	X		
OIM	OI	O-Ring Insert	M			
OIMB	OI		M			B=Bulkhead
OIM134V	OI		M		R134a	
OTF	OT	O-Ring Tube	F	Yes		
OTF12V	OT		F	Yes	R12	
OTF134V	OT		F	Yes	R134a	
OTF134VHS	OT		F	Yes	R134a	HS=High Pressure Side
OTM	OT		M	Yes		
OTMLP	OT		M	Yes		LP=Long Pilot
OTM134V	OT		M	Yes	R134a	
SFFX	SF	SAE 45° J512 Flare	F	X		
SFM	SF		M			
SWA	SW	Sealing Washer				A=Accumulator
SWCN	SW					CN=Compressor Narrow
SWCW	SW					CW=Compressor Wide
VC12V	VC	Valve Cap			R12	
VC134VHS	VC				R134a	HS=High Pressure Side
VC134VLS	VC				R134a	LS=Low Pressure Side

**Additional Prefix & Suffix:**

- 45 = 45° Elbow
- 45B = 45° Block Elbow
- 90 = 90° Elbow
- 90B = 90° Block Elbow
- 180 = 180° Elbow
- A = Aluminum

Part # GC-OTF134V45  
 134V=R134a Valve  
 45 = 45° Elbow



OTF = O-Ring Tube Female

## How to Use the Fitting Tables

This section lists ALL fittings that are compatible with the following hoses:

### Hose Family      Hose Descriptive

G4826	GALAXY® G4826 (SAE J2064)
G4867	GALAXY® G4867 (SAE J2064)
G4890	GALAXY® G4890 (SAE J2064)

The Continental ContiTech hose, compatible with each fitting style in this section, is shown at the right, above the "Compatible Hose Family" heading.

The fitting styles are different for each hose family. The fittings listed in each "Compatible Hose Family" section are the only approved fittings for the hose shown.

Be sure to use only those fittings shown for the hose families listed in the heading.

### "AC" (Crimp) Fittings - For use with GALAXY® G4826 (5/16"-5/8") & G4867 (3/4") Hose

## Fitting Description

## Compatible Hose Family

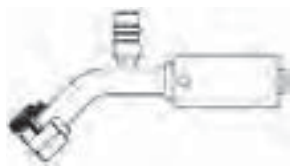

Descriptive #	Product #	SAP #	Hose Size ID		Thread	Drop (D)		Cut-Off (R)		Valve (V)	
			in.	mm	Size	in.	mm	in.	mm	in.	mm
AC-OTF134V45-0606	50663-0606	20307056	5/16	7.90	5/8-18	0.55	14	1.61	41	0.63	16
AC-OTF134V45-0808	50663-0808	20306728	13/32	10.30	3/4-16	0.63	16	1.61	41	0.63	16
AC-OTF134V45-1010	50663-1010	20307057	1/2	12.70	7/8-14	0.87	22	1.73	44	0.51	13
AC-OTF134V45-1210	50663-1210	20306729	5/8	15.90	7/8-14	0.94	24	1.89	48	0.51	13
AC-OTF134V45-1212	50663-1212	20307058	5/8	15.90	1 1/16-14	0.94	24	1.89	48	0.51	13
AC-OTF134V45-1412	50663-1412	20307059	3/4	19.05	1 1/16-14	0.94	24	1.89	48	0.51	13

“AC” (Crimp) Fittings - For use with GALAXY® G4826 (5/16"-5/8") & G4867 (3/4") Hose

## Compressor O-Ring Tube

Female | 45° Elbow



Descriptive #	Product #	SAP #	Hose Size ID		Thread Size	Drop (D)		Cut-Off (R)		Valve (V)	
			in.	mm		in.	mm	in.	mm	in.	mm
AC-COTF45-0810	50133-0810	20306551	13/32	10.30	1-14	1.10	28	2.01	51		
AC-COTF45-1010	50133-1010	20306545	1/2	12.70	1-14	1.26	32	1.38	35		
AC-COTF45-1210	50133-1210	20306546	5/8	15.90	1-14	0.67	17	1.26	32		

## Compressor O-Ring Tube

Female | 90° Elbow



Descriptive #	Product #	SAP #	Hose Size ID		Thread Size	Drop (D)		Cut-Off (R)		Valve (V)	
			in.	mm		in.	mm	in.	mm	in.	mm
AC-COTF90-0810	50135-0810	20306547	13/32	10.30	1-14	1.93	49	1.77	45		
AC-COTF90-1010	50135-1010	20306548	1/2	12.70	1-14	2.20	56	1.77	45		
AC-COTF90-1210	50135-1210	20306549	5/8	15.90	1-14	2.72	69	2.36	60		

## Compressor O-Ring Tube

Female | 90° Block Elbow

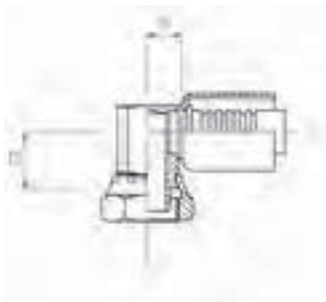

Descriptive #	Product #	SAP #	Hose Size ID		Thread Size	Drop (D)		Cut-Off (R)		Valve (V)	
			in.	mm		in.	mm	in.	mm	in.	mm
AC-COTF90B-0810	50137-0810	20306610	13/32	10.30	1-14	0.83	21	0.94	24		
AC-COTF90B-1010	50137-1010	20306611	1/2	12.70	1-14	0.83	21	0.94	24		
AC-COTF90B-1210	50137-1210	20306612	5/8	15.90	1-14	0.83	21	1.06	27		

## Compressor O-Ring Tube

Female | R134a Valve | 90° Block Elbow

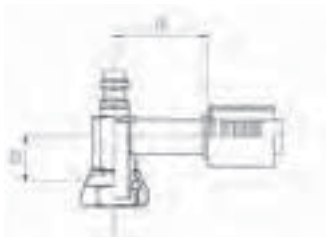

Descriptive #	Product #	SAP #	Hose Size ID		Thread Size	Drop (D)		Cut-Off (R)		Valve (V)	
			in.	mm		in.	mm	in.	mm	in.	mm
AC-COTF134V90B-0810	50145-0810	20306990	13/32	10.30	1-14	0.83	21	0.94	24	0.63	16
AC-COTF134V90B-1010	50145-1010	20306991	1/2	12.70	1-14	0.83	21	0.94	24	0.51	13
AC-COTF134V90B-1210	50145-1210	20306992	5/8	15.90	1-14	0.83	21	1.06	27	0.51	13

“AC” (Crimp) Fittings - For use with GALAXY® G4826 (5/16"-5/8") & G4867 (3/4") Hose

# Flareless Tube

Male



Descriptive #	Product #	SAP #	Hose Size ID		Thread Size	Drop (D)		Cut-Off (R)		Valve (V)	
			in.	mm		in.	mm	in.	mm	in.	mm
AC-FTM-0606	50230-0606	20306613	5/16	7.90	5/8-18			1.46	37		
AC-FTM-0806	50230-0806	20306615	13/32	10.30	5/8-18			1.61	41		
AC-FTM-0808	50230-0808	20306616	13/32	10.30	3/4-16			1.61	41		
AC-FTM-0810	50230-0810	20306617	13/32	10.30	7/8-14			2.13	54		
AC-FTM-1008	50230-1008	20306618	1/2	12.70	3/4-16			2.13	54		
AC-FTM-1010	50230-1010	20306619	1/2	12.70	7/8-14			2.13	54		
AC-FTM-1210	50230-1210	20306620	5/8	15.90	7/8-14			2.36	60		
AC-FTM-1212	50230-1212	20306621	5/8	15.90	1 1/16-14			2.36	60		

# Flareless Tube

Male | 90° Block Elbow



Descriptive #	Product #	SAP #	Hose Size ID		Thread Size	Drop (D)		Cut-Off (R)		Valve (V)	
			in.	mm		in.	mm	in.	mm	in.	mm
AC-FTM90B-0606	50235-0606	20306622	5/16	7.90	5/8-18	1.50	38	1.06	27		
AC-FTM90B-0808	50235-0808	20306623	13/32	10.30	3/4-16	1.73	44	1.26	32		
AC-FTM90B-0810	50235-0810	20306624	13/32	10.30	7/8-14	2.01	51	1.50	38		
AC-FTM90B-1008	50235-1008	20306625	1/2	12.70	3/4-16	2.01	51	1.50	38		
AC-FTM90B-1010	50235-1010	20306626	1/2	12.70	7/8-14	2.01	51	1.50	38		
AC-FTM90B-1210	50235-1210	20306627	5/8	15.90	7/8-14	2.36	60	2.36	60		
AC-FTM90B-1212	50235-1212	20306628	5/8	15.90	1 1/16-14	2.36	60	2.36	60		

# Flareless Tube

Male | Metric

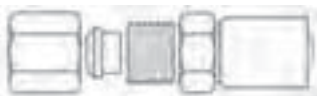

Descriptive #	Product #	SAP #	Hose Size ID		Thread Size	Drop (D)		Cut-Off (R)		Valve (V)	
			in.	mm		in.	mm	in.	mm	in.	mm
AC-FTMM-0608	50240-0608	20306629	5/16	7.90	5/8-18			1.61	41		
AC-FTMM-0812	50240-0812	20306630	13/32	10.30	3/4-16			2.13	54		
AC-FTMM-1015	50240-1015	20306631	1/2	12.70	7/8-14			2.36	60		

“AC” (Crimp) Fittings - For use with GALAXY® G4826 (5/16"-5/8") & G4867 (3/4") Hose

## Hose Mender



Descriptive #	Product #	SAP #	Hose Size ID		Thread Size	Drop (D)		Cut-Off (R)		Valve (V)	
			in.	mm		in.	mm	in.	mm	in.	mm
AC-HM-0606	50350-0606	20306643	5/16	7.90				1.73	44		
AC-HM-0608	50350-0608	20306644	5/16	7.90				1.73	44		
AC-HM-0808	50350-0808	20306645	13/32	10.30				1.61	41		
AC-HM-0810	50350-0810	20306646	13/32	10.30				1.73	44		
AC-HM-1010	50350-1010	20306647	1/2	12.70				1.73	44		
AC-HM-1210	50350-1210	20306648	5/8	15.90				1.73	44		
AC-HM-1212	50350-1212	20306649	5/8	15.90				2.01	51		

## Hose Mender

90° Elbow



Descriptive #	Product #	SAP #	Hose Size ID		Thread Size	Drop (D)		Cut-Off (R)		Valve (V)	
			in.	mm		in.	mm	in.	mm	in.	mm
AC-HM90-0606	50355-0606	20306650	5/16	7.90	0.98	25	0.98	25			
AC-HM90-0808	50355-0808	20306651	13/32	10.30	1.73	44	1.73	44			
AC-HM90-1010	50355-1010	20306652	1/2	12.70	2.24	57	2.24	57			
AC-HM90-1212	50355-1212	20306653	5/8	15.90	2.64	67	2.64	67			

## Hose Mender

R12 Valve



Descriptive #	Product #	SAP #	Hose Size ID		Thread Size	Drop (D)		Cut-Off (R)		Valve (V)	
			in.	mm		in.	mm	in.	mm	in.	mm
AC-HM12V-0606	50365-0606	20306658	5/16	7.90				1.61	41	1/4	6.35
AC-HM12V-0808	50365-0808	20306659	13/32	10.30				1.73	44	1/4	6.35
AC-HM12V-1010	50365-1010	20306670	1/2	12.70				1.61	41	1/4	6.35
AC-HM12V-1212	50365-1212	20306671	5/8	15.90				1.73	44	1/4	6.35

## Hose Mender

R134a Valve

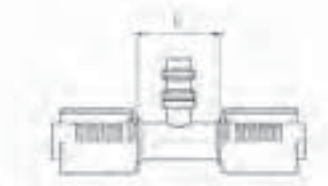

Descriptive #	Product #	SAP #	Hose Size ID		Thread Size	Drop (D)		Cut-Off (R)		Valve (V)	
			in.	mm		in.	mm	in.	mm	in.	mm
AC-HM134V-0606	50370-0606	20306672	5/16	7.90				1.73	44	0.63	16
AC-HM134V-0808	50370-0808	20306673	13/32	10.30				1.73	44	0.63	16
AC-HM134V-1010	50370-1010	20306674	1/2	12.70				1.73	44	0.51	13
AC-HM134V-1212	50370-1212	20306675	5/8	15.90				2.01	47	0.51	13

“AC” (Crimp) Fittings - For use with GALAXY® G4826 (5/16"-5/8") & G4867 (3/4") Hose

## Hose Mender with Sight Glass



Descriptive #	Product #	SAP #	Hose Size ID		Thread Size	Drop (D)		Cut-Off (R)		Valve (V)	
			in.	mm		in.	mm	in.	mm	in.	mm
AC-HMSG-0606	50375-0606	20306993	5/16	7.90				1.61	41		

## Hose Mender, Tee

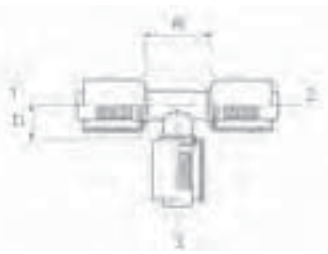

Descriptive #	Product #	SAP #	Hose Size ID 1 & 2		Hose ID 3		Drop (D)		Cut-Off (R)		Valve (V)	
			in.	mm	in.	mm	in.	mm	in.	mm	in.	mm
AC-HMT-0606	50380-0606	20306676	5/16	7.90	5/16	7.90	0.98	25	1.93	49		
AC-HMT-0808	50380-0808	20306677	13/32	10.30	13/32	10.30	1.26	32	2.05	52		
AC-HMT-1010	50380-1010	20306678	1/2	12.70	1/2	12.70	1.26	32	2.24	57		
AC-HMT-1210	50380-1210	20306994	5/8	15.90	1/2	12.70	1.38	35	2.05	52		
AC-HMT-1212	50380-1212	20306679	5/8	15.90	5/8	15.90	1.26	32	2.05	52		

## O-Ring Insert

Male

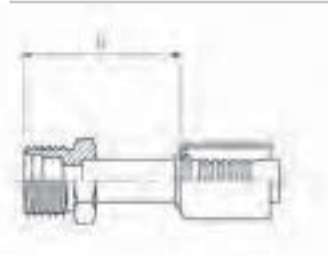

Descriptive #	Product #	SAP #	Hose Size ID		Thread Size	Drop (D)		Cut-Off (R)		Valve (V)	
			in.	mm		in.	mm	in.	mm	in.	mm
AC-OIM-0606	50500-0606	20306684	5/16	7.90	5/8-18			1.46	37		
AC-OIM-0808	50500-0808	20306685	13/32	10.30	3/4-16			1.61	41		
AC-OIM-1010	50500-1010	20306686	1/2	12.70	7/8-14			2.13	54		
AC-OIM-1210	50500-1210	20306687	5/8	15.90	7/8-14			1.69	43		
AC-OIM-1212	50500-1212	20306688	5/8	15.90	1 1/16-14			2.36	60		
AC-OIM-1412	50500-1412	20307000	3/4	19.05	1 1/16-14			2.36	60		

## O-Ring Insert

Male | 45° Elbow

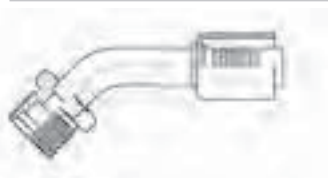

Descriptive #	Product #	SAP #	Hose Size ID		Thread Size	Drop (D)		Cut-Off (R)		Valve (V)	
			in.	mm		in.	mm	in.	mm	in.	mm
AC-OIM45-0606	50503-0606	20307001	5/16	7.90	5/8-18	0.75	19	0.83	21		
AC-OIM45-0808	50503-0808	20307002	13/32	10.30	3/4-16	0.98	25	0.94	24		
AC-OIM45-1010	50503-1010	20307003	1/2	12.70	7/8-14	1.26	32	1.26	32		
AC-OIM45-1212	50503-1212	20307004	5/8	15.90	1 1/16-14	1.38	35	1.50	38		
AC-OIM45-1412	50503-1412	20307005	3/4	19.05	1 1/16-14	1.38	35	1.50	38		

“AC” (Crimp) Fittings - For use with GALAXY® G4826 (5/16"-5/8") & G4867 (3/4") Hose

O-Ring Insert

Male | 90° Elbow

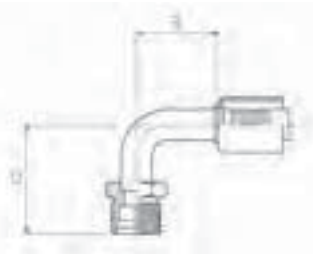

Descriptive #	Product #	SAP #	Hose Size ID		Thread Size	Drop (D)		Cut-Off (R)		Valve (V)	
			in.	mm		in.	mm	in.	mm	in.	mm
AC-OIM90-0606	50505-0606	20306689	5/16	7.90	5/8-18	1.50	38	1.06	27		
AC-OIM90-0808	50505-0808	20306690	13/32	10.30	3/4-16	1.73	44	1.26	32		
AC-OIM90-1010	50505-1010	20306691	1/2	12.70	7/8-14	2.01	51	1.50	38		
AC-OIM90-1210	50505-1210	20307006	5/8	15.90	7/8-14	2.17	55	1.97	50		
AC-OIM90-1212	50505-1212	20307007	5/8	15.90	1 1/16-14	2.52	64	2.36	60		
AC-OIM90-1412	50505-1412	20307008	3/4	19.05	1 1/16-14	2.52	64	2.36	60		

O-Ring Insert

Male | Bulkhead

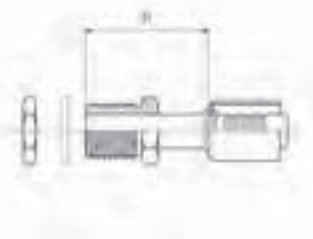

Descriptive #	Product #	SAP #	Hose Size ID		Thread Size	Drop (D)		Cut-Off (R)		Valve (V)	
			in.	mm		in.	mm	in.	mm	in.	mm
AC-OIMB-0606	50515-0606	20307009	5/16	7.90	5/8-18			2.52	64		
AC-OIMB-0808	50515-0808	20307010	13/32	10.30	3/4-16			2.76	70		
AC-OIMB-1010	50515-1010	20307011	1/2	12.70	7/8-14			2.95	75		

O-Ring Insert

Male | Bulkhead | 90° Elbow

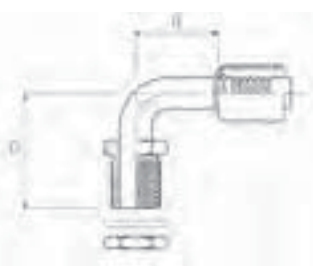

Descriptive #	Product #	SAP #	Hose Size ID		Thread Size	Drop (D)		Cut-Off (R)		Valve (V)	
			in.	mm		in.	mm	in.	mm	in.	mm
AC-OIMB90-0606	50520-0606	20307012	5/16	7.90	5/8-18	2.13	54	1.61	41		
AC-OIMB90-0808	50520-0808	20307013	13/32	10.30	3/4-16	2.44	62	1.73	44		
AC-OIMB90-1010	50520-1010	20307014	5/8	15.90	7/8-14	2.52	64	2.01	51		

O-Ring Insert

Male | R134a Valve



Descriptive #	Product #	SAP #	Hose Size ID		Thread Size	Drop (D)		Cut-Off (R)		Valve (V)	
			in.	mm		in.	mm	in.	mm	in.	mm
AC-OIM134V-0606	50530-0606	20307015	5/16	7.90	5/8-18			2.44	62	0.63	16
AC-OIM134V-0808	50530-0808	20307016	13/32	10.30	3/4-16			2.56	65	0.63	16
AC-OIM134V-1010	50530-1010	20307017	1/2	12.70	7/8-14			1.77	45	0.51	13
AC-OIM134V-1212	50530-1212	20307018	5/8	15.90	1 1/16-14			2.95	75	0.51	13

“AC” (Crimp) Fittings - For use with GALAXY® G4826 (5/16"-5/8") & G4867 (3/4") Hose

## O-Ring Insert

Male | R134a Valve | 90° Elbow

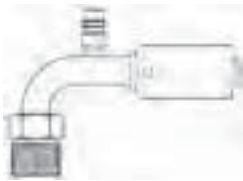

Descriptive #	Product #	SAP #	Hose Size ID		Thread Size	Drop (D)		Cut-Off (R)		Valve (V)	
			in.	mm		in.	mm	in.	mm	in.	mm
AC-OIM134V90-0606	50535-0606	20307019	5/16	7.90	5/8-18	1.61	41	2.13	54	0.63	16
AC-OIM134V90-0808	50535-0808	20307020	13/32	10.30	3/4-16	1.89	48	2.13	54	0.63	16
AC-OIM134V90-1010	50535-1010	20307021	1/2	12.70	7/8-14	2.13	54	2.36	60	0.51	13

## O-Ring Tube

Female | Swivel

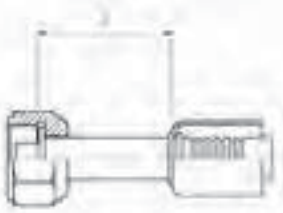

Descriptive #	Product #	SAP #	Hose Size ID		Thread Size	Drop (D)		Cut-Off (R)		Valve (V)	
			in.	mm		in.	mm	in.	mm	in.	mm
AC-OTF-0605	50600-0605	20307022	5/16	7.90	9/16-18			1.30	33		
AC-OTF-0606	50600-0606	20306692	5/16	7.90	5/8-18			1.38	35		
AC-OTF-0608	50600-0608	20306693	5/16	7.90	3/4-16			1.50	38		
AC-OTF-0806	50600-0806	20307023	13/32	10.30	5/8-18			1.50	38		
AC-OTF-0808	50600-0808	20306694	13/32	10.30	3/4-16			1.50	38		
AC-OTF-1008	50600-1008	20307024	1/2	12.70	3/4-16			1.69	43		
AC-OTF-1010	50600-1010	20306695	1/2	12.70	7/8-14			1.69	43		
AC-OTF-1012	50600-1012	20307025	1/2	12.70	1 1/16-14			1.81	46		
AC-OTF-1210	50600-1210	20306696	5/8	15.90	7/8-14			1.81	46		
AC-OTF-1212	50600-1212	20306697	5/8	15.90	1 1/16-14			1.81	46		
AC-OTF-1412	50600-1412	20307026	3/4	19.05	1 1/16-14			1.81	46		

## O-Ring Tube

Female | Swivel | 45° Elbow

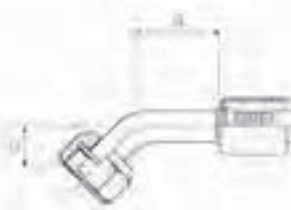

Descriptive #	Product #	SAP #	Hose Size ID		Thread Size	Drop (D)		Cut-Off (R)		Valve (V)	
			in.	mm		in.	mm	in.	mm	in.	mm
AC-OTF45-0606	50603-0606	20306698	5/16	7.90	5/8-18	0.55	14	0.83	21		
AC-OTF45-0806	50603-0806	20307027	13/32	10.30	5/8-18	0.63	16	0.94	24		
AC-OTF45-0808	50603-0808	20306699	13/32	10.30	3/4-16	0.63	16	0.94	24		
AC-OTF45-1010	50603-1010	20306700	1/2	12.70	7/8-14	0.87	22	1.26	32		
AC-OTF45-1210	50603-1210	20306701	5/8	15.90	7/8-14	0.94	24	1.50	38		
AC-OTF45-1212	50603-1212	20306702	5/8	15.90	1 1/16-14	0.94	24	1.50	38		
AC-OTF45-1412	50603-1412	20307028	3/4	19.05	1 1/16-14	0.94	24	1.50	38		



“AC” (Crimp) Fittings - For use with GALAXY® G4826 (5/16"-5/8") & G4867 (3/4") Hose

O-Ring Tube

Female | Swivel | 90° Elbow

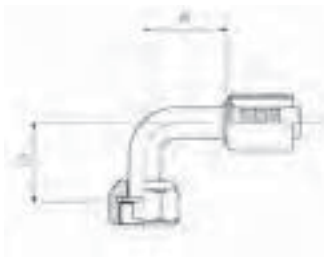

Descriptive #	Product #	SAP #	Hose Size ID		Thread Size	Drop (D)		Cut-Off (R)		Valve (V)	
			in.	mm		in.	mm	in.	mm	in.	mm
AC-OTF90-0605	50605-0605	20307029	5/16	7.90	9/16-18	1.10	28	1.26	32		
AC-OTF90-0606	50605-0606	20306703	5/16	7.90	5/8-18	1.10	28	1.06	27		
AC-OTF90-0608	50605-0608	20306704	5/16	7.90	3/4-16	1.30	33	1.26	32		
AC-OTF90-0806	50605-0806	20307030	13/32	10.30	5/8-18	1.30	33	1.26	32		
AC-OTF90-0808	50605-0808	20306705	13/32	10.30	3/4-16	1.30	33	1.26	32		
AC-OTF90-1008	50605-1008	20307031	1/2	12.70	3/4-16	1.50	38	1.50	38		
AC-OTF90-1010	50605-1010	20306706	1/2	12.70	7/8-14	1.50	38	1.50	38		
AC-OTF90-1012	50605-1012	20307032	1/2	12.70	1 1/16-14	1.77	45	1.77	45		
AC-OTF90-1210	50605-1210	20306707	5/8	15.90	7/8-14	1.77	45	1.77	45		
AC-OTF90-1212	50605-1212	20306708	5/8	15.90	1 1/16-14	1.77	45	1.77	45		
AC-OTF90-1412	50605-1412	20307033	3/4	19.05	1 1/16-14	1.77	45	1.77	45		

O-Ring Tube

Female | Swivel | 90° Block Elbow

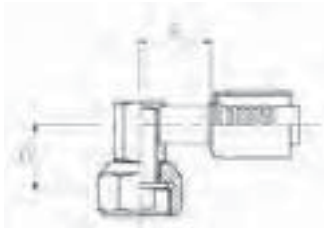

Descriptive #	Product #	SAP #	Hose Size ID		Thread Size	Drop (D)		Cut-Off (R)		Valve (V)	
			in.	mm		in.	mm	in.	mm	in.	mm
AC-OTF90B-0808	50610-0808	20306709	13/32	10.30	3/4-16	0.75	19	0.94	24		
AC-OTF90B-1010	50610-1010	20306710	1/2	12.70	7/8-14	0.75	19	0.98	25		
AC-OTF90B-1210	50610-1210	20306711	5/8	15.90	7/8-14	0.75	19	0.98	25		

O-Ring Tube

Female | Swivel | 180° Elbow

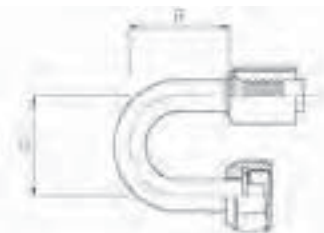

Descriptive #	Product #	SAP #	Hose Size ID		Thread Size	Drop (D)		Cut-Off (R)		Valve (V)	
			in.	mm		in.	mm	in.	mm	in.	mm
AC-OTF180-0606	50615-0606	20307034	5/16	7.90	5/8-18	1.61	41	2.01	51		
AC-OTF180-0808	50615-0808	20307035	13/32	10.30	3/4-16	1.73	44	2.01	51		
AC-OTF180-1212	50615-1212	20307036	5/8	15.90	1 1/16-14	2.13	54	2.99	76		

O-Ring Tube

Female | Swivel | Metric

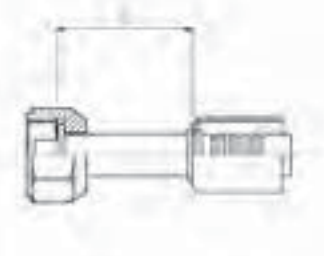

Descriptive #	Product #	SAP #	Hose Size ID		Thread Size	Drop (D)		Cut-Off (R)		Valve (V)	
			in.	mm		in.	mm	in.	mm	in.	mm
AC-OTFM-0616	50630-0616	20306712	5/16	7.90	16x1.5			1.54	39		
AC-OTFM-0618	50630-0618	20307037	5/16	7.90	18x1.5			1.54	39		
AC-OTFM-0620	50630-0620	20307038	5/16	7.90	20x1.5			1.54	39		
AC-OTFM-0820	50630-0820	20307039	13/32	10.30	20x1.5			1.69	43		
AC-OTFM-1022	50630-1022	20306713	1/2	12.70	22x1.5			1.69	43		
AC-OTFM-1024	50630-1024	20306714	1/2	12.70	24x2.0			1.69	43		
AC-OTFM-1227	50630-1227	20306715	5/8	15.90	27x2.0			1.81	46		

“AC” (Crimp) Fittings - For use with GALAXY® G4826 (5/16"-5/8") & G4867 (3/4") Hose

## O-Ring Tube

Female | Swivel | Metric | 45° Elbow

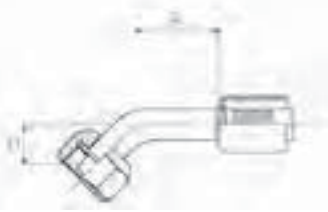

Descriptive #	Product #	SAP #	Hose Size ID		Thread Size	Drop (D)		Cut-Off (R)		Valve (V)	
			in.	mm		in.	mm	in.	mm	in.	mm
AC-OTFM45-0614	50633-0614	20307040	5/16	7.90	14x1.5	0.55	14	0.98	25		
AC-OTFM45-0616	50633-0616	20307041	5/16	7.90	16x1.5	0.55	14	0.98	25		
AC-OTFM45-0618	50633-0618	20307042	5/16	7.90	18x1.5	0.55	14	0.98	25		
AC-OTFM45-0620	50633-0620	20307043	5/16	7.90	20x1.5	0.55	14	0.98	25		
AC-OTFM45-0820	50633-0820	20307044	13/32	10.30	20x1.5	0.63	16	0.98	25		
AC-OTFM45-1022	50633-1022	20307045	1/2	12.70	22x1.5	0.87	22	1.26	32		
AC-OTFM45-1024	50633-1024	20307046	1/2	12.70	24x2.0	0.87	22	1.26	32		
AC-OTFM45-1227	50633-1227	20307047	5/8	15.90	27x2.0	0.94	24	1.50	38		

## O-Ring Tube

Female | Swivel | Metric | 90° Elbow

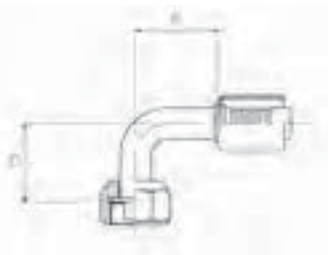

Descriptive #	Product #	SAP #	Hose Size ID		Thread Size	Drop (D)		Cut-Off (R)		Valve (V)	
			in.	mm		in.	mm	in.	mm	in.	mm
AC-OTFM90-0616	50635-0616	20306716	5/16	7.90	16x1.5	1.10	28	1.06	27		
AC-OTFM90-0618	50635-0618	20307048	5/16	7.90	18x1.5	1.10	28	1.06	27		
AC-OTFM90-0620	50635-0620	20307049	5/16	7.90	20x1.5	1.10	28	1.06	27		
AC-OTFM90-0820	50635-0820	20307050	13/32	10.30	20x1.5	1.30	33	1.26	32		
AC-OTFM90-1022	50635-1022	20306717	1/2	12.70	22x1.5	1.50	38	1.50	38		
AC-OTFM90-1024	50635-1024	20306718	1/2	12.70	24x2.0	1.50	38	1.50	38		
AC-OTFM90-1227	50635-1227	20306719	5/8	15.90	27x2.0	1.77	45	1.77	45		

## O-Ring Tube

Female | Swivel | R12 Valve

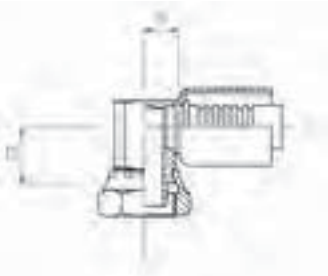

Descriptive #	Product #	SAP #	Hose Size ID		Thread Size	Drop (D)		Cut-Off (R)		Valve (V)	
			in.	mm		in.	mm	in.	mm	in.	mm
AC-OTF12V-0606	50650-0606	20307051	5/16	7.90	5/8-18			1.89	48	1/4	6.35
AC-OTF12V-0808	50650-0808	20307052	13/32	10.30	3/4-16			1.89	48	1/4	6.35
AC-OTF12V-1010	50650-1010	20307053	1/2	12.70	7/8-14			2.13	54	1/4	6.35

## O-Ring Tube

Female | Swivel | R12 Valve | 90° Elbow

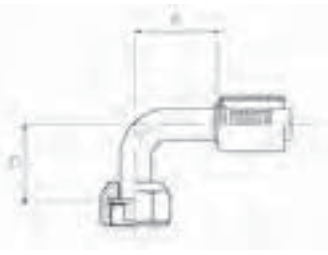

Descriptive #	Product #	SAP #	Hose Size ID		Thread Size	Drop (D)		Cut-Off (R)		Valve (V)	
			in.	mm		in.	mm	in.	mm	in.	mm
AC-OTF12V90-0606	50655-0606	20306720	5/16	7.90	5/8-18	1.10	28	2.13	54	1/4	6.35
AC-OTF12V90-0808	50655-0808	20306721	13/32	10.30	3/4-16	1.30	33	2.13	54	1/4	6.35
AC-OTF12V90-1010	50655-1010	20306722	1/2	12.70	7/8-14	1.50	38	2.36	60	1/4	6.35
AC-OTF12V90-1210	50655-1210	20306723	5/8	15.90	7/8-14	1.73	44	2.68	68	1/4	6.35

“AC” (Crimp) Fittings - For use with GALAXY® G4826 (5/16"-5/8") & G4867 (3/4") Hose

O-Ring Tube

Female | Swivel | R134a Valve

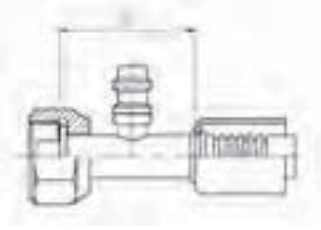

Descriptive #	Product #	SAP #	Hose Size ID		Thread Size	Drop (D)		Cut-Off (R)		Valve (V)	
			in.	mm		in.	mm	in.	mm	in.	mm
AC-OTF134V-0606	50660-0606	20306724	5/16	7.90	5/8-18			1.89	48	0.63	16
AC-OTF134V-0808	50660-0808	20306725	13/32	10.30	3/4-16			1.89	48	0.63	16
AC-OTF134V-1010	50660-1010	20306726	1/2	12.70	7/8-14			2.13	54	0.51	13
AC-OTF134V-1210	50660-1210	20306727	5/8	15.90	7/8-14			2.24	57	0.51	13
AC-OTF134V-1212	50660-1212	20307054	5/8	15.90	1 1/16-14			2.24	57	0.51	13
AC-OTF134V-1412	50660-1412	20307055	3/4	19.05	1 1/16-14			2.24	57	0.51	13
AC-OTF134VHS-1010	50675-1010	20307063	1/2	12.70	7/8-14			2.13	54	0.63	16

O-Ring Tube

Female | Swivel | R134a Valve | 45° Elbow

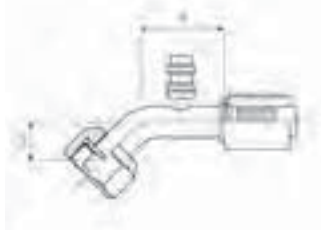

Descriptive #	Product #	SAP #	Hose Size ID		Thread Size	Drop (D)		Cut-Off (R)		Valve (V)	
			in.	mm		in.	mm	in.	mm	in.	mm
AC-OTF134V45-0606	50663-0606	20307056	5/16	7.90	5/8-18	0.55	14	1.61	41	0.63	16
AC-OTF134V45-0808	50663-0808	20306728	13/32	10.30	3/4-16	0.63	16	1.61	41	0.63	16
AC-OTF134V45-1010	50663-1010	20307057	1/2	12.70	7/8-14	0.87	22	1.73	44	0.51	13
AC-OTF134V45-1210	50663-1210	20306729	5/8	15.90	7/8-14	0.94	24	1.89	48	0.51	13
AC-OTF134V45-1212	50663-1212	20307058	5/8	15.90	1 1/16-14	0.94	24	1.89	48	0.51	13
AC-OTF134V45-1412	50663-1412	20307059	3/4	19.05	1 1/16-14	0.94	24	1.89	48	0.51	13

O-Ring Tube

Female | Swivel | R134a Valve | 90° Elbow

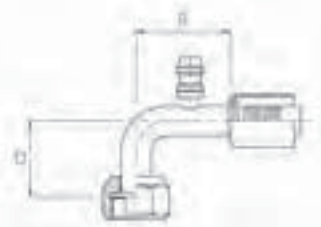

Descriptive #	Product #	SAP #	Hose Size ID		Thread Size	Drop (D)		Cut-Off (R)		Valve (V)	
			in.	mm		in.	mm	in.	mm	in.	mm
AC-OTF134V90-0606	50665-0606	20306730	5/16	7.90	5/8-18	1.10	28	2.13	54	0.63	16
AC-OTF134V90-0806	50665-0806	20307060	13/32	10.30	5/8-18	1.30	33	2.13	54	0.63	16
AC-OTF134V90-0808	50665-0808	20306731	13/32	10.30	3/4-16	1.30	33	2.13	54	0.63	16
AC-OTF134V90-1010	50665-1010	20306732	1/2	12.70	7/8-14	1.50	38	2.36	60	0.51	13
AC-OTF134V90-1210	50665-1210	20306733	5/8	15.90	7/8-14	1.73	44	2.68	68	0.51	13
AC-OTF134V90-1212	50665-1212	20307061	5/8	15.90	1 1/16-14	1.73	44	2.68	68	0.51	13
AC-OTF134V90-1412	50665-1412	20307062	3/4	19.05	1 1/16-14	1.73	44	2.68	68	0.51	13

“AC” (Crimp) Fittings - For use with GALAXY® G4826 (5/16"-5/8") & G4867 (3/4") Hose

O-Ring Tube

Male | Swivel

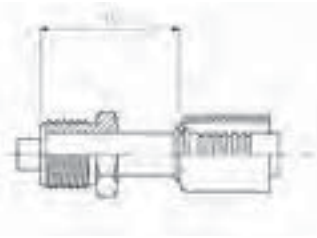

Descriptive #	Product #	SAP #	Hose Size ID		Thread Size	Drop (D)		Cut-Off (R)		Valve (V)	
			in.	mm		in.	mm	in.	mm	in.	mm
AC-OTM-0606	50700-0606	20306734	5/16	7.90	5/8-18			1.69	43		
AC-OTM-0607	50700-0607	20306735	5/16	7.90	11/16-16			1.69	43		
AC-OTM-0608	50700-0608	20306736	5/16	7.90	3/4-18			1.77	45		
AC-OTM-0808	50700-0808	20306737	13/32	10.30	3/4-18			1.77	45		
AC-OTM-1010	50700-1010	20306738	1/2	12.70	7/8-18			1.89	48		
AC-OTM-1012	50700-1012	20306739	1/2	12.70	1 1/16-16			2.36	60		
AC-OTM-1210	50700-1210	20306740	5/8	15.90	7/8-18			2.36	60		
AC-OTM-1212	50700-1212	20306741	5/8	15.90	1 1/16-16			2.36	60		

O-Ring Tube

Male | Swivel | 45° Elbow

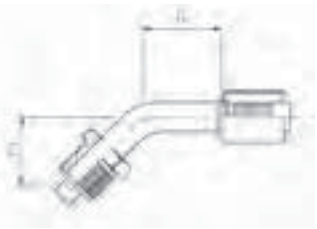

Descriptive #	Product #	SAP #	Hose Size ID		Thread Size	Drop (D)		Cut-Off (R)		Valve (V)	
			in.	mm		in.	mm	in.	mm	in.	mm
AC-OTM45-0606	50703-0606	20306742	5/16	7.90	5/8-18	0.87	22	0.83	21		
AC-OTM45-0808	50703-0808	20306743	13/32	10.30	3/4-18	0.98	25	0.94	24		
AC-OTM45-1010	50703-1010	20306744	1/2	12.70	7/8-18	1.06	27	1.26	32		
AC-OTM45-1210	50703-1210	20306745	5/8	15.90	7/8-18	1.18	30	1.50	38		
AC-OTM45-1212	50703-1212	20306746	5/8	15.90	1 1/16-16	1.18	30	1.50	38		

O-Ring Tube

Male | Swivel | 90° Elbow

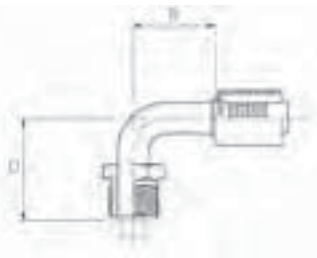

Descriptive #	Product #	SAP #	Hose Size ID		Thread Size	Drop (D)		Cut-Off (R)		Valve (V)	
			in.	mm		in.	mm	in.	mm	in.	mm
AC-OTM90-0606	50705-0606	20306747	5/16	7.90	5/8-18	1.61	41	1.06	27		
AC-OTM90-0608	50705-0608	20306748	5/16	7.90	3/4-18	1.89	48	1.26	32		
AC-OTM90-0806	50705-0806	20306749	13/32	10.30	5/8-18	1.89	48	1.26	32		
AC-OTM90-0808	50705-0808	20306750	13/32	10.30	3/4-18	1.89	48	1.26	32		
AC-OTM90-1010	50705-1010	20306751	1/2	12.70	7/8-18	2.13	54	1.50	38		
AC-OTM90-1012	50705-1012	20306752	1/2	12.70	1 1/16-16	2.24	57	1.77	45		
AC-OTM90-1210	50705-1210	20306753	5/8	15.90	7/8-18	2.24	57	1.77	45		
AC-OTM90-1212	50705-1212	20306754	5/8	15.90	1 1/16-16	2.24	57	1.77	45		

“AC” (Crimp) Fittings - For use with GALAXY® G4826 (5/16"-5/8") & G4867 (3/4") Hose

O-Ring Tube

Male | Swivel | Long Pilot

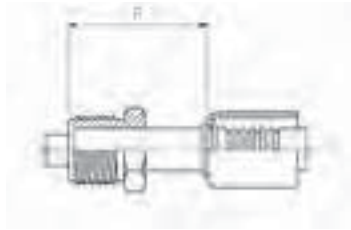

Descriptive #	Product #	SAP #	Hose Size ID		Thread Size	Drop (D)		Cut-Off (R)		Valve (V)	
			in.	mm		in.	mm	in.	mm	in.	mm
AC-OTMLP-0606	50720-0606	20307064	5/16	7.90	5/8-18			1.06	27		
AC-OTMLP-0808	50720-0808	20307065	13/32	10.30	3/4-18			1.26	32		
AC-OTMLP-1010	50720-1010	20307066	1/2	12.70	7/8-18			1.50	38		
AC-OTMLP-1210	50720-1210	20307067	5/8	15.90	7/8-18			1.77	45		

O-Ring Tube

Male | Swivel | R134a Valve



Descriptive #	Product #	SAP #	Hose Size ID		Thread Size	Drop (D)		Cut-Off (R)		Valve (V)	
			in.	mm		in.	mm	in.	mm	in.	mm
AC-OTM134V-0606	50730-0606	20307068	5/16	7.90	5/8-18			1.69	43	0.63	16
AC-OTM134V-0808	50730-0808	20307069	13/32	10.30	3/4-18			1.77	45	0.63	16
AC-OTM134V-1010	50730-1010	20307070	1/2	12.70	7/8-18			2.36	60	0.51	13
AC-OTM134V-1210	50730-1210	20306755	5/8	15.90	7/8-18			2.36	60	0.51	13
AC-OTM134V-1212	50730-1212	20307071	5/8	15.90	1 1/16-16			2.52	64	0.51	13

O-Ring Tube

Male | Swivel | R134a Valve | 90° Elbow

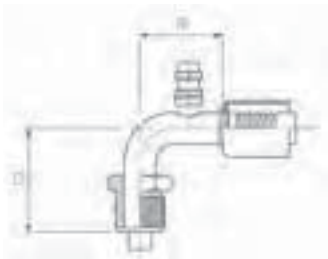

Descriptive #	Product #	SAP #	Hose Size ID		Thread Size	Drop (D)		Cut-Off (R)		Valve (V)	
			in.	mm		in.	mm	in.	mm	in.	mm
AC-OTM134V90-1010	50735-1010	20307072	1/2	12.70	7/8-18	2.13	54	2.36	60	0.51	13
AC-OTM134V90-1210	50735-1210	20306756	5/8	15.90	7/8-18	2.13	54	2.36	60	0.51	13

SAE 45° Flare

Female | Swivel

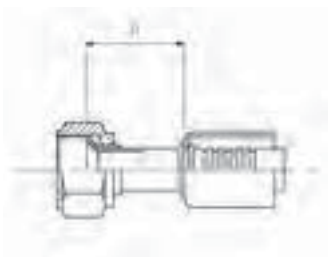

Descriptive #	Product #	SAP #	Hose Size ID		Thread Size	Drop (D)		Cut-Off (R)		Valve (V)	
			in.	mm		in.	mm	in.	mm	in.	mm
AC-SFFX-0606	50760-0606	20306757	5/16	7.90	5/8-18			1.38	35		
AC-SFFX-0608	50760-0608	20306758	5/16	7.90	3/4-16			1.18	30		
AC-SFFX-0806	50760-0806	20307073	13/32	10.30	5/8-18			1.18	30		
AC-SFFX-0808	50760-0808	20306759	13/32	10.30	3/4-16			1.18	30		
AC-SFFX-1008	50760-1008	20307074	1/2	12.70	3/4-16			1.50	38		
AC-SFFX-1010	50760-1010	20306760	1/2	12.70	7/8-14			1.50	38		
AC-SFFX-1210	50760-1210	20306761	5/8	15.90	7/8-14			1.73	44		
AC-SFFX-1212	50760-1212	20306762	5/8	15.90	1 1/16-14			1.73	44		

## "AC" (Crimp) Fittings - For use with GALAXY® G4826 (5/16"-5/8") &amp; G4867 (3/4") Hose

## SAE 45° Flare

Female | Swivel

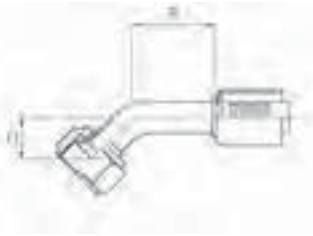

Descriptive #	Product #	SAP #	Hose Size ID		Thread Size	Drop (D)		Cut-Off (R)		Valve (V)	
			in.	mm		in.	mm	in.	mm	in.	mm
AC-SFFX45-0606	50763-0606	20306763	5/16	7.90	5/8-18	0.55	14	0.83	21		
AC-SFFX45-0608	50763-0608	20306764	5/16	7.90	3/4-16	0.63	16	0.94	24		
AC-SFFX45-0806	50763-0806	20307075	13/32	10.30	5/8-18	0.63	16	0.94	24		
AC-SFFX45-0808	50763-0808	20306765	13/32	10.30	3/4-16	0.63	16	0.94	24		
AC-SFFX45-1008	50763-1008	20307076	1/2	12.70	3/4-16	0.87	22	1.26	32		
AC-SFFX45-1010	50763-1010	20306766	1/2	12.70	7/8-14	0.87	22	1.26	32		
AC-SFFX45-1210	50763-1210	20306767	5/8	15.90	7/8-14	0.98	25	1.50	38		
AC-SFFX45-1212	50763-1212	20306768	5/8	15.90	1 1/16-14	0.98	25	1.50	38		

## SAE 45° Flare

Female | Swivel | 90° Elbow

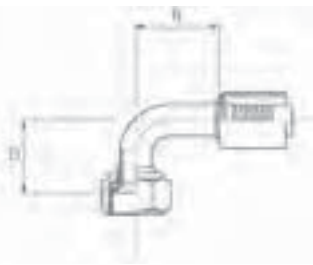

Descriptive #	Product #	SAP #	Hose Size ID		Thread Size	Drop (D)		Cut-Off (R)		Valve (V)	
			in.	mm		in.	mm	in.	mm	in.	mm
AC-SFFX90-0606	50765-0606	20306769	5/16	7.90	5/8-18	1.06	27	1.06	27		
AC-SFFX90-0608	50765-0608	20306770	5/16	7.90	3/4-16	1.26	32	1.26	32		
AC-SFFX90-0806	50765-0806	20307077	13/32	10.30	5/8-18	1.26	32	1.26	32		
AC-SFFX90-0808	50765-0808	20306771	13/32	10.30	3/4-16	1.26	32	1.26	32		
AC-SFFX90-1008	50765-1008	20307078	1/2	12.70	3/4-16	1.50	38	1.50	38		
AC-SFFX90-1010	50765-1010	20306772	1/2	12.70	7/8-14	1.50	38	1.50	38		
AC-SFFX90-1210	50765-1210	20306773	5/8	15.90	7/8-14	1.50	38	1.73	44		
AC-SFFX90-1212	50765-1212	20306774	5/8	15.90	1 1/16-14	1.50	38	1.73	44		

## SAE 45° Flare

Male

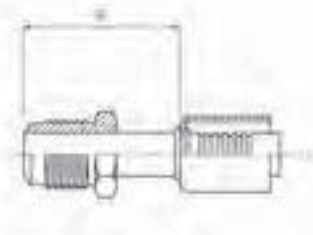

Descriptive #	Product #	SAP #	Hose Size ID		Thread Size	Drop (D)		Cut-Off (R)		Valve (V)	
			in.	mm		in.	mm	in.	mm	in.	mm
AC-SFM-0606A	50780-0606	20306775	5/16	7.90	5/8-18			1.89	48		
AC-SFM-0808A	50780-0808	20306776	13/32	10.30	3/4-16			2.01	51		
AC-SFM-1010A	50780-1010	20306777	1/2	12.70	7/8-14			2.32	59		
AC-SFM-1212A	50780-1212	20306778	5/8	15.90	1 1/16-14			2.52	64		

“AC” (Crimp) Fittings - For use with GALAXY® G4826 (5/16"-5/8") & G4867 (3/4") Hose

SAE 45° Flare

Male | 45° Elbow



Descriptive #	Product #	SAP #	Hose Size ID		Thread Size	Drop (D)		Cut-Off (R)		Valve (V)	
			in.	mm		in.	mm	in.	mm	in.	mm
AC-SFM45-0606A	50783-0606	20306779	5/16	7.90	5/8-18	1.50	38	1.06	27		
AC-SFM45-0808A	50783-0808	20306780	13/32	10.30	3/4-16	1.73	44	1.26	32		
AC-SFM45-1010A	50783-1010	20306781	1/2	12.70	7/8-14	2.01	51	1.50	38		
AC-SFM45-1212A	50783-1212	20306782	5/8	15.90	1 1/16-14	2.52	64	2.36	60		

SAE 45° Flare

Male | 90° Elbow



Descriptive #	Product #	SAP #	Hose Size ID		Thread Size	Drop (D)		Cut-Off (R)		Valve (V)	
			in.	mm		in.	mm	in.	mm	in.	mm
AC-SFM90-0606A	50785-0606	20306783	5/16	7.90	5/8-18	0.75	19	0.83	21		
AC-SFM90-0808A	50785-0808	20306784	13/32	10.30	3/4-16	0.98	25	0.94	24		
AC-SFM90-1010A	50785-1010	20306785	1/2	12.70	7/8-14	1.26	32	1.26	32		
AC-SFM90-1212A	50785-1212	20306786	5/8	15.90	1 1/16-14	1.38	35	1.50	38		

“GC” Cool Clip® Fittings - For use with GALAXY® G4890 Hose

Compressor Pad Block

R12 Valve/Switch | 90° Block Elbow

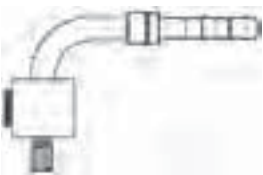

Descriptive #	Product #	SAP #	Hose Size ID		Thread Size	Drop (D)		Cut-Off (R)		Valve (V)	
			in.	mm		in.	mm	in.	mm	in.	mm
GC-CB12VS90-0808	54110-0808	20307089	13/32	10.30		2.63	66.8	3.00	76.2	1/4	6.35
GC-CB12VS90-1008	54110-1008	20307090	1/2	12.70		2.63	66.8	3.00	76.2	1/4	6.35
GC-CB12VS90-1208	54110-1208	20307091	5/8	15.90		2.63	66.8	3.00	76.2	1/4	6.35

Compressor Pad Block

R12 Valve/Switch Reversed | 90° Elbow

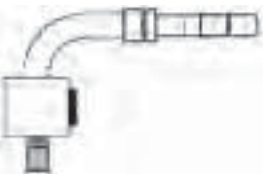

Descriptive #	Product #	SAP #	Hose Size ID		Thread Size	Drop (D)		Cut-Off (R)		Valve (V)	
			in.	mm		in.	mm	in.	mm	in.	mm
GC-CB12VSR90-0808	54112-0808	20307092	13/32	10.30		2.63	66.8	1.88	47.6	1/4	6.35
GC-CB12VSR90-1008	54112-1008	20307093	1/2	12.70		2.63	66.8	1.88	47.6	1/4	6.35
GC-CB12VSR90-1208	54112-1208	20307094	5/8	15.90		2.63	66.8	1.88	47.6	1/4	6.35

“GC” Cool Clip® Fittings - For use with GALAXY® G4890 Hose

## Compressor O-Ring Tube

Female | 45° Elbow



Descriptive #	Product #	SAP #	Hose Size ID		Thread Size	Drop (D)		Cut-Off (R)		Valve (V)	
			in.	mm		in.	mm	in.	mm	in.	mm
GC-COTF45-0810	54133-0810	20306806	13/32	10.30	1-14	0.39	10	2.01	51		
GC-COTF45-1010	54133-1010	20306807	1/2	12.70	1-14	0.39	10	2.01	51		
GC-COTF45-1210	54133-1210	20306808	5/8	15.90	1-14	0.39	10	2.01	51		

## Compressor O-Ring Tube

Female | 90° Elbow

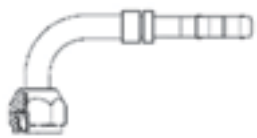

Descriptive #	Product #	SAP #	Hose Size ID		Thread Size	Drop (D)		Cut-Off (R)		Valve (V)	
			in.	mm		in.	mm	in.	mm	in.	mm
GC-COTF90-0810	54135-0810	20306809	13/32	10.30	1-14	0.91	23	2.13	54		
GC-COTF90-1010	54135-1010	20306810	1/2	12.70	1-14	0.91	23	2.13	54		
GC-COTF90-1210	54135-1210	20306811	5/8	15.90	1-14	0.91	23	2.13	54		

## Compressor O-Ring Tube

Female | 90° Block Elbow

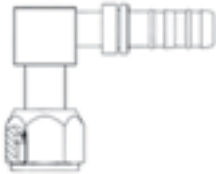

Descriptive #	Product #	SAP #	Hose Size ID		Thread Size	Drop (D)		Cut-Off (R)		Valve (V)	
			in.	mm		in.	mm	in.	mm	in.	mm
GC-COTF90B-0810	54137-0810	20306812	13/32	10.30	1-14	0.91	23	2.32	59		
GC-COTF90B-1010	54137-1010	20306813	1/2	12.70	1-14	0.91	23	2.32	59		
GC-COTF90B-1210	54137-1210	20306814	5/8	15.90	1-14	0.91	23	2.32	59		

## Compressor O-Ring Tube

Female | R134a Valve | 90° Block Elbow

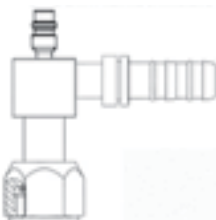

Descriptive #	Product #	SAP #	Hose Size ID		Thread Size	Drop (D)		Cut-Off (R)		Valve (V)	
			in.	mm		in.	mm	in.	mm	in.	mm
GC-COTF134V90B-0810	54145-0810	20307095	13/32	10.30	1-14	0.91	23	2.32	59	0.63	16
GC-COTF134V90B-1010	54145-1010	20307096	1/2	12.70	1-14	0.91	23	2.32	59	0.51	13
GC-COTF134V90B-1210	54145-1210	20307097	5/8	15.90	1-14	0.91	23	2.32	59	0.51	13

## Flareless Tube

Braze-On



Descriptive #	Product #	SAP #	Hose Size ID		Fitting Size	Drop (D)		Cut-Off (R)		Valve (V)	
			in.	mm		in.	mm	in.	mm	in.	mm
GC-FTBO-0606	54210-0606	20306815	5/16	7.90	3/8			1.81	46		
GC-FTBO-0808	54210-0808	20306816	13/32	10.30	1/2			1.81	46		
GC-FTBO-1010	54210-1010	20306817	1/2	12.70	5/8			1.81	46		
GC-FTBO-1210	54210-1210	20306818	5/8	15.90	5/8			1.81	46		
GC-FTBO-1212	54210-1212	20306819	5/8	15.90	3/4			1.81	46		



“GC” Cool Clip® Fittings - For use with GALAXY® G4890 Hose

## Flareless Tube

Male



Descriptive #	Product #	SAP #	Hose Size ID		Thread Size	Drop (D)		Cut-Off (R)		Valve (V)	
			in.	mm		in.	mm	in.	mm	in.	mm
GC-FTM-0606	54230-0606	20306820	5/16	7.90	5/8-18			2.80	71		
GC-FTM-0608	54230-0608	20306821	5/16	7.90	3/4-16			2.80	71		
GC-FTM-0806	54230-0806	20306822	13/32	10.30	5/8-18			2.80	71		
GC-FTM-0808	54230-0808	20306823	13/32	10.30	3/4-16			2.91	74		
GC-FTM-0810	54230-0810	20306824	13/32	10.30	7/8-14			2.91	74		
GC-FTM-1008	54230-1008	20306825	1/2	12.70	3/4-16			3.15	80		
GC-FTM-1010	54230-1010	20306826	1/2	12.70	7/8-14			3.15	80		
GC-FTM-1210	54230-1210	20306827	5/8	15.90	7/8-14			3.66	93		
GC-FTM-1212	54230-1212	20306828	5/8	15.90	1 1/16-14			3.66	93		

## Flareless Tube

Male | 90° Block Elbow



Descriptive #	Product #	SAP #	Hose Size ID		Thread Size	Drop (D)		Cut-Off (R)		Valve (V)	
			in.	mm		in.	mm	in.	mm	in.	mm
GC-FTM90B-0606	54235-0606	20306829	5/16	7.90	5/8-18	1.22	31	1.42	36		
GC-FTM90B-0608	54235-0608	20307098	5/16	7.90	3/4-16	1.22	31	1.42	36		
GC-FTM90B-0806	54235-0806	20307099	13/32	10.30	5/8-18	1.22	31	1.42	36		
GC-FTM90B-0808	54235-0808	20306830	13/32	10.30	3/4-16	1.73	44	1.61	41		
GC-FTM90B-0810	54235-0810	20306831	13/32	10.30	7/8-14	1.73	44	1.61	41		
GC-FTM90B-1008	54235-1008	20306832	1/2	12.70	3/4-16	1.73	44	1.61	41		
GC-FTM90B-1010	54235-1010	20306833	1/2	12.70	7/8-14	2.09	53	1.93	49		
GC-FTM90B-1210	54235-1210	20306834	5/8	15.90	7/8-14	2.52	64	2.64	67		
GC-FTM90B-1212	54235-1212	20306835	5/8	15.90	1 1/16-14	2.52	64	2.64	67		

## Flareless Tube

Male | Metric



Descriptive #	Product #	SAP #	Hose Size ID		Thread Size	Drop (D)		Cut-Off (R)		Valve (V)	
			in.	mm		in.	mm	in.	mm	in.	mm
GC-FTMM-0608	54240-0608	20306836	5/16	7.90	5/8-18			2.80	71		
GC-FTMM-0812	54240-0812	20306837	13/32	10.30	3/4-16			2.91	74		
GC-FTMM-1015	54240-1015	20306838	1/2	12.70	7/8-14			3.66	93		

## "GC" Cool Clip® Fittings - For use with GALAXY® G4890 Hose

## Ford Spring Lock

Female

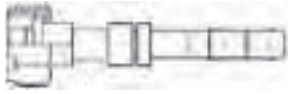

Descriptive #	Product #	SAP #	Hose Size ID		Thread Size	Drop (D)		Cut-Off (R)		Valve (V)	
			in.	mm		in.	mm	in.	mm	in.	mm
GC-FSLF-0606A	54300-0606A	20306839	5/16	7.90	FSL-06			2.87	73		
GC-FSLF-0608A	54300-0608A	20306840	5/16	7.90	FSL-08			2.87	73		
GC-FSLF-0808A	54300-0808A	20306841	13/32	10.30	FSL-08			3.11	79		
GC-FSLF-1010A	54300-1010A	20306842	1/2	12.70	FSL-10			3.31	84		
GC-FSLF-1210A	54300-1210A	20306843	5/8	15.90	FSL-10			3.31	84		
GC-FSLF-1212A	54300-1212A	20306844	5/8	15.90	FSL-12			3.31	84		

## Ford Spring Lock

Female | 45° Elbow



Descriptive #	Product #	SAP #	Hose Size ID		Thread Size	Drop (D)		Cut-Off (R)		Valve (V)	
			in.	mm		in.	mm	in.	mm	in.	mm
GC-FSLF45-0606A	54303-0606A	20307100	5/16	7.90	FSL-06	1.30	33	1.85	47		
GC-FSLF45-0608A	54303-0608A	20307101	5/16	7.90	FSL-08	1.30	33	1.85	47		
GC-FSLF45-0808A	54303-0808A	20307102	13/32	10.30	FSL-08	1.30	33	1.30	33		
GC-FSLF45-1210A	54303-1210A	20307104	5/8	15.90	FSL-10	1.42	36	1.61	41		
GC-FSLF45-1212A	54303-1212A	20307105	5/8	15.90	FSL-12	1.42	36	1.61	41		

## Ford Spring Lock

Female | 90° Elbow



Descriptive #	Product #	SAP #	Hose Size ID		Thread Size	Drop (D)		Cut-Off (R)		Valve (V)	
			in.	mm		in.	mm	in.	mm	in.	mm
GC-FSLF90-0606A	54305-0606A	20306845	5/16	7.90	FSL-06	2.13	54	1.97	50		
GC-FSLF90-0608A	54305-0608A	20307106	5/16	7.90	FSL-08	2.13	54	1.97	50		
GC-FSLF90-0808A	54305-0808A	20306846	13/32	10.30	FSL-08	2.44	62	2.09	53		
GC-FSLF90-1010A	54305-1010A	20306847	1/2	12.70	FSL-10	2.52	64	2.36	60		
GC-FSLF90-1210A	54305-1210A	20307107	5/8	15.90	FSL-10	2.52	64	2.36	60		
GC-FSLF90-1212A	54305-1212A	20306848	5/8	15.90	FSL-12	2.52	64	2.36	60		

## Ford Spring Lock

Male

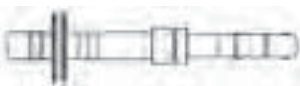

Descriptive #	Product #	SAP #	Hose Size ID		Thread Size	Drop (D)		Cut-Off (R)		Valve (V)	
			in.	mm		in.	mm	in.	mm	in.	mm
GC-FSLM-0606A	54330-0606A	20306849	5/16	7.90	FSL-06			2.72	69		
GC-FSLM-0608A	54330-0608A	20307108	5/16	7.90	FSL-08			2.72	69		
GC-FSLM-1010A	54330-1010A	20306851	1/2	12.70	FSL-10			2.99	76		
GC-FSLM-1210A	54330-1210A	20306852	5/8	15.90	FSL-10			2.99	76		
GC-FSLM-1212A	54330-1212A	20306853	5/8	15.90	FSL-12			3.11	79		

“GC” Cool Clip® Fittings - For use with GALAXY® G4890 Hose

## Ford Spring Lock

Male | 45° Elbow



Descriptive #	Product #	SAP #	Hose Size ID		Thread Size	Drop (D)		Cut-Off (R)		Valve (V)	
			in.	mm		in.	mm	in.	mm	in.	mm
GC-FSLM45-0606A	54333-0606A	20307109	5/16	7.90	FSL-06	1.30	33	1.85	47		
GC-FSLM45-0608A	54333-0608A	20307110	5/16	7.90	FSL-08	1.30	33	1.85	47		
GC-FSLM45-0808A	54333-0808A	20307111	13/32	10.30	FSL-08	1.26	32	1.30	33		
GC-FSLM45-1010A	54333-1010A	20307112	1/2	12.70	FSL-10	1.42	36	1.61	41		
GC-FSLM45-1210A	54333-1210A	20307113	5/8	15.90	FSL-10	1.42	36	1.61	41		
GC-FSLM45-1212A	54333-1212A	20307114	5/8	15.90	FSL-12	1.42	36	1.61	41		

## Ford Spring Lock

Male | 90° Elbow

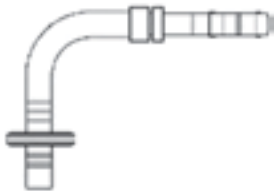

Descriptive #	Product #	SAP #	Hose Size ID		Thread Size	Drop (D)		Cut-Off (R)		Valve (V)	
			in.	mm		in.	mm	in.	mm	in.	mm
GC-FSLM90-0606A	54335-0606A	20307115	5/16	7.90	FSL-06	2.13	54	1.97	50		
GC-FSLM90-0608A	54335-0608A	20307116	5/16	7.90	FSL-08	2.13	54	1.97	50		
GC-FSLM90-0808A	54335-0808A	20307117	13/32	10.30	FSL-08	2.44	62	2.09	53		
GC-FSLM90-1010A	54335-1010A	20307118	1/2	12.70	FSL-10	2.52	64	2.36	60		
GC-FSLM90-1210A	54335-1210A	20307119	5/8	15.90	FSL-10	2.52	64	2.36	60		
GC-FSLM90-1212A	54335-1212A	20307120	5/8	15.90	FSL-12	2.52	64	2.36	60		

## Hose Mender

GC Cool Clip® Fittings



Descriptive #	Product #	SAP #	Hose Size ID		Thread Size	Drop (D)		Cut-Off (R)		Valve (V)	
			in.	mm		in.	mm	in.	mm	in.	mm
GC-HM-0606	54350-0606	20306854	5/16	7.90				2.17	55		
GC-HM-0608	54350-0608	20306855	5/16	7.90				2.17	55		
GC-HM-0808	54350-0808	20306856	13/32	10.30				2.17	55		
GC-HM-0810	54350-0810	20306857	13/32	10.30				2.17	55		
GC-HM-1010	54350-1010	20306858	1/2	12.70				2.17	55		
GC-HM-1210	54350-1210	20306859	5/8	15.90				2.17	55		
GC-HM-1212	54350-1212	20306860	5/8	15.90				2.17	55		

## Hose Mender

90° Elbow

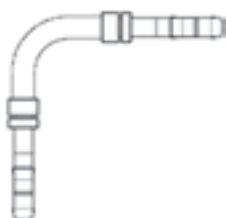

Descriptive #	Product #	SAP #	Hose Size ID		Thread Size	Drop (D)		Cut-Off (R)		Valve (V)	
			in.	mm		in.	mm	in.	mm	in.	mm
GC-HM90-0606	54355-0606	20306861	5/16	7.90		0.94	24	0.94	24		
GC-HM90-0808	54355-0808	20306862	13/32	10.30		1.14	29	1.14	29		
GC-HM90-1010	54355-1010	20306863	1/2	12.70		1.34	34	1.34	34		
GC-HM90-1212	54355-1212	20306864	5/8	15.90		1.54	39	1.54	39		

“GC” Cool Clip® Fittings - For use with GALAXY® G4890 Hose

## Hose Mender

180° Elbow

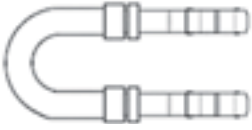

Descriptive #	Product #	SAP #	Hose Size ID		Thread Size	Drop (D)		Cut-Off (R)		Valve (V)	
			in.	mm		in.	mm	in.	mm	in.	mm
GC-HM180-0606	54360-0606	20306865	5/16	7.90		1.97	50	2.48	63		
GC-HM180-0808	54360-0808	20306866	13/32	10.30		2.36	60	2.48	63		
GC-HM180-1010	54360-1010	20306867	1/2	12.70		2.76	70	2.83	72		
GC-HM180-1212	54360-1212	20306868	5/8	15.90		3.15	80	3.50	89		

## Hose Mender

R12 Valve



Drawing has R134a Valve  
Fittings have R12 Valve

Descriptive #	Product #	SAP #	Hose Size ID		Thread Size	Drop (D)		Cut-Off (R)		Valve (V)	
			in.	mm		in.	mm	in.	mm	in.	mm
GC-HM12V-0606	54365-0606	20306869	5/16	7.90				2.17	55	1/4	6.35
GC-HM12V-0808	54365-0808	20306870	13/32	10.30				2.17	55	1/4	6.35
GC-HM12V-1010	54365-1010	20306871	1/2	12.70				2.17	55	1/4	6.35
GC-HM12V-1212	54365-1212	20306872	5/8	15.90				2.17	55	1/4	6.35

## Hose Mender

R134a Valve



Descriptive #	Product #	SAP #	Hose Size ID		Thread Size	Drop (D)		Cut-Off (R)		Valve (V)	
			in.	mm		in.	mm	in.	mm	in.	mm
GC-HM134V-0606	54370-0606	20306873	5/16	7.90				2.17	55	0.63	16
GC-HM134V-0808	54370-0808	20306874	13/32	10.30				2.17	55	0.63	16
GC-HM134V-1010	54370-1010	20306875	1/2	12.70				2.17	55	0.51	13
GC-HM134V-1212	54370-1212	20306876	5/8	15.90				2.17	55	0.51	13

## Hose Mender

with Sight Glass



Fitting has sight glass in place  
of R134a Valve

Descriptive #	Product #	SAP #	Hose Size ID		Thread Size	Drop (D)		Cut-Off (R)		Valve (V)	
			in.	mm		in.	mm	in.	mm	in.	mm
GC-HMSG-0606	54375-0606	20307121	5/16	7.90				2.48	63		

“GC” Cool Clip® Fittings - For use with GALAXY® G4890 Hose

## Hose Mender

Tee

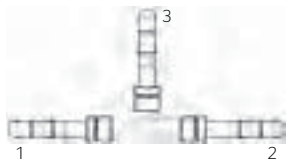

Descriptive #	Product #	SAP #	Hose Size ID 1 & 2		Hose ID 3		Drop (D)		Cut-Off (R)		Valve (V)	
			in.	mm	in.	mm	in.	mm	in.	mm	in.	mm
GC-HMT-0606	54380-0606	20306877	5/16	7.90	5/16	7.90	1.22	31	2.44	62		
GC-HMT-0808	54380-0808	20306878	13/32	10.30	13/32	10.30	1.30	33	2.60	66		
GC-HMT-1010	54380-1010	20306879	1/2	12.70	1/2	12.70	1.73	44	2.72	69		
GC-HMT-1210	54380-1210	20307122	5/8	15.90	1/2	12.70	1.73	44	2.72	69		
GC-HMT-1212	54380-1212	20306880	5/8	15.90	5/8	15.90	1.73	44	2.95	75		

## O-Ring Face Seal

Female | Swivel



Descriptive #	Product #	SAP #	Hose Size ID		Thread Size	Drop (D)		Cut-Off (R)		Valve (V)	
			in.	mm		in.	mm	in.	mm	in.	mm
GC-OFFX-0606	54430-0606	20307123	5/16	7.90	11/16-16			1.77	45		
GC-OFFX-0808	54430-0808	20307124	13/32	10.30	13/16-16			1.97	50		
GC-OFFX-1010	54430-1010	20307125	1/2	12.70	1-14			2.48	63		
GC-OFFX-1212	54430-1212	20307126	5/8	15.90	1 3/16-12			2.72	69		

## O-Ring Face Seal

Female | Swivel | 90° Elbow

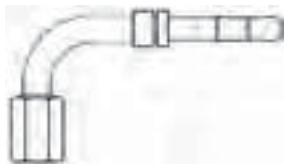

Descriptive #	Product #	SAP #	Hose Size ID		Thread Size	Drop (D)		Cut-Off (R)		Valve (V)	
			in.	mm		in.	mm	in.	mm	in.	mm
GC-OFFX90-0606	54435-0606	20306881	5/16	7.90	11/16-16	1.14	29	0.94	24		
GC-OFFX90-0808	54435-0808	20306882	13/32	10.30	13/16-16	1.34	34	1.14	29		
GC-OFFX90-1010	54435-1010	20307127	1/2	12.70	1-14	1.57	40	1.34	34		
GC-OFFX90-1212	54435-1212	20307128	5/8	15.90	1 3/16-12	1.81	46	1.54	39		

## O-Ring Insert

Male



Descriptive #	Product #	SAP #	Hose Size ID		Thread Size	Drop (D)		Cut-Off (R)		Valve (V)	
			in.	mm		in.	mm	in.	mm	in.	mm
GC-OIM-0606	54500-0606	20306887	5/16	7.90	5/8-18			2.80	71		
GC-OIM-0808	54500-0808	20306888	13/32	10.30	3/4-16			2.91	74		
GC-OIM-1010	54500-1010	20306889	1/2	12.70	7/8-14			2.13	54		
GC-OIM-1210	54500-1210	20306890	5/8	15.90	7/8-14			2.13	54		
GC-OIM-1212	54500-1212	20306891	5/8	15.90	1 1/16-14			3.31	84		

## "GC" Cool Clip® Fittings - For use with GALAXY® G4890 Hose

## O-Ring Insert

Male | 45° Elbow



Descriptive #	Product #	SAP #	Hose Size ID		Thread Size	Drop (D)		Cut-Off (R)		Valve (V)	
			in.	mm		in.	mm	in.	mm	in.	mm
GC-OIM45-0606	54503-0606	20307130	5/16	7.90	5/8-18	0.75	19	1.18	30		
GC-OIM45-0808	54503-0808	20307131	13/32	10.30	3/4-16	0.94	24	1.30	33		
GC-OIM45-1010	54503-1010	20307132	1/2	12.70	7/8-14	1.26	32	1.61	41		
GC-OIM45-1212	54503-1212	20307133	5/8	15.90	1 1/16-14	1.38	35	1.77	45		

## O-Ring Insert

Male | 90° Elbow

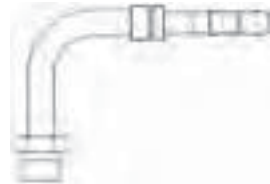

Descriptive #	Product #	SAP #	Hose Size ID		Thread Size	Drop (D)		Cut-Off (R)		Valve (V)	
			in.	mm		in.	mm	in.	mm	in.	mm
GC-OIM90-0606	54505-0606	20306892	5/16	7.90	5/8-18	1.38	35	2.13	54		
GC-OIM90-0808	54505-0808	20306893	13/32	10.30	3/4-16	1.73	44	1.61	41		
GC-OIM90-1010	54505-1010	20306894	1/2	12.70	7/8-14	2.17	55	2.32	59		
GC-OIM90-1210	54505-1210	20307134	5/8	15.90	7/8-14	2.17	55	2.32	59		
GC-OIM90-1212	54505-1212	20307135	5/8	15.90	1 1/16-14	2.76	70	2.32	59		

## O-Ring Insert

Male | Bulkhead

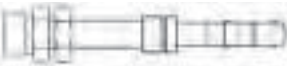

Descriptive #	Product #	SAP #	Hose Size ID		Thread Size	Drop (D)		Cut-Off (R)		Valve (V)	
			in.	mm		in.	mm	in.	mm	in.	mm
GC-OIMB-0606	54515-0606	20307136	5/16	7.90	5/8-18			3.15	80		
GC-OIMB-0808	54515-0808	20307137	13/32	10.30	3/4-16			3.15	80		
GC-OIMB-1010	54515-1010	20307138	1/2	12.70	7/8-14			3.15	80		

## O-Ring Insert

Male | Bulkhead | 90° Elbow

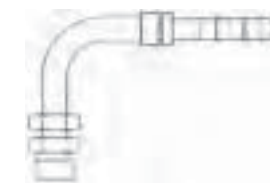

Descriptive #	Product #	SAP #	Hose Size ID		Thread Size	Drop (D)		Cut-Off (R)		Valve (V)	
			in.	mm		in.	mm	in.	mm	in.	mm
GC-OIMB90-0606	54520-0606	20307139	5/16	7.90	5/8-18	2.13	54	1.97	50		
GC-OIMB90-0808	54520-0808	20307140	13/32	10.30	3/4-16	2.44	62	2.09	53		
GC-OIMB90-1010	54520-1010	20307141	5/8	15.90	7/8-14	2.52	64	2.36	60		

“GC” Cool Clip® Fittings - For use with GALAXY® G4890 Hose

## O-Ring Insert

R134a Valve



Descriptive #	Product #	SAP #	Hose Size ID		Thread Size	Drop (D)		Cut-Off (R)		Valve (V)	
			in.	mm		in.	mm	in.	mm	in.	mm
GC-OIM134V-0606	54530-0606	20307142	5/16	7.90	5/8-18			2.80	71	0.63	16
GC-OIM134V-0808	54530-0808	20307143	13/32	10.30	3/4-16			2.91	74	0.63	16
GC-OIM134V-1010	54530-1010	20307144	1/2	12.70	7/8-14			2.13	54	0.51	13
GC-OIM134V-1212	54530-1212	20307145	5/8	15.90	1 1/16-14			3.31	84	0.51	13

## O-Ring Insert

R134a Valve | 90° Elbow

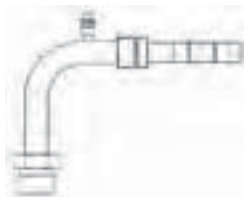

Descriptive #	Product #	SAP #	Hose Size ID		Thread Size	Drop (D)		Cut-Off (R)		Valve (V)	
			in.	mm		in.	mm	in.	mm	in.	mm
GC-OIM134V90-0606	54535-0606	20307146	5/16	7.90	5/8-18	1.38	35	2.13	54	0.63	16
GC-OIM134V90-0808	54535-0808	20307147	13/32	10.30	3/4-16	1.73	44	1.61	41	0.63	16
GC-OIM134V90-1010	54535-1010	20307148	1/2	12.70	7/8-14	2.17	55	2.32	59	0.51	13

## O-Ring Tube

Female | Swivel



Descriptive #	Product #	SAP #	Hose Size ID		Thread Size	Drop (D)		Cut-Off (R)		Valve (V)	
			in.	mm		in.	mm	in.	mm	in.	mm
GC-OTF-0605	54600-0605	20307149	5/16	7.90	9/16-18			1.42	36		
GC-OTF-0606	54600-0606	20306895	5/16	7.90	5/8-18			1.42	36		
GC-OTF-0608	54600-0608	20306896	5/16	7.90	3/4-16			1.57	40		
GC-OTF-0806	54600-0806	20307150	13/32	10.30	5/8-18			1.57	40		
GC-OTF-0808	54600-0808	20306897	13/32	10.30	3/4-16			1.57	40		
GC-OTF-1008	54600-1008	20307151	1/2	12.70	3/4-16			1.57	40		
GC-OTF-1010	54600-1010	20306898	1/2	12.70	7/8-14			1.97	50		
GC-OTF-1012	54600-1012	20307152	1/2	12.70	1 1/16-14			2.09	53		
GC-OTF-1210	54600-1210	20306899	5/8	15.90	7/8-14			1.97	50		
GC-OTF-1212	54600-1212	20306900	5/8	15.90	1 1/16-14			2.09	53		

## O-Ring Tube

Female | Swivel | 45° Elbow



Descriptive #	Product #	SAP #	Hose Size ID		Thread Size	Drop (D)		Cut-Off (R)		Valve (V)	
			in.	mm		in.	mm	in.	mm	in.	mm
GC-OTF45-0606	54603-0606	20306901	5/16	7.90	5/8-18	0.55	14	1.02	26		
GC-OTF45-0806	54603-0806	20307153	13/32	10.30	5/8-18	0.55	14	1.02	26		
GC-OTF45-0808	54603-0808	20306902	13/32	10.30	3/4-16	0.59	15	2.13	54		
GC-OTF45-1008	54603-1008	20307154	1/2	12.70	3/4-16	0.59	15	2.13	54		
GC-OTF45-1010	54603-1010	20306903	1/2	12.70	7/8-14	0.67	17	2.13	54		
GC-OTF45-1210	54603-1210	20306904	5/8	15.90	7/8-14	0.67	17	2.13	54		
GC-OTF45-1212	54603-1212	20306905	5/8	15.90	1 1/16-14	1.18	30	2.13	54		

## "GC" Cool Clip® Fittings - For use with GALAXY® G4890 Hose

## O-Ring Tube

Female | Swivel | 90° Elbow

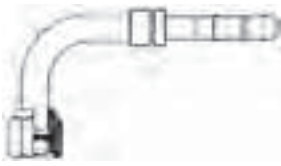

Descriptive #	Product #	SAP #	Hose Size ID		Thread Size	Drop (D)		Cut-Off (R)		Valve (V)	
			in.	mm		in.	mm	in.	mm	in.	mm
GC-OTF90-0605	54605-0605	20307155	5/16	7.90	9/16-18	1.26	32	1.46	37		
GC-OTF90-0606	54605-0606	20306906	5/16	7.90	5/8-18	1.26	32	1.46	37		
GC-OTF90-0608	54605-0608	20306907	5/16	7.90	3/4-16	1.42	36	1.77	45		
GC-OTF90-0806	54605-0806	20307156	13/32	10.30	5/8-18	1.65	42	2.17	55		
GC-OTF90-0808	54605-0808	20306908	13/32	10.30	3/4-16	1.42	36	1.77	45		
GC-OTF90-1008	54605-1008	20307157	1/2	12.70	3/4-16	1.42	36	1.77	45		
GC-OTF90-1010	54605-1010	20306909	1/2	12.70	7/8-14	1.65	42	2.17	55		
GC-OTF90-1012	54605-1012	20307158	1/2	12.70	1 1/16-14	1.77	45	2.40	61		
GC-OTF90-1210	54605-1210	20306910	5/8	15.90	7/8-14	1.65	42	2.17	55		
GC-OTF90-1212	54605-1212	20306911	5/8	15.90	1 1/16-14	1.77	45	2.40	61		

## O-Ring Tube

Female | Swivel | 90° Block Elbow

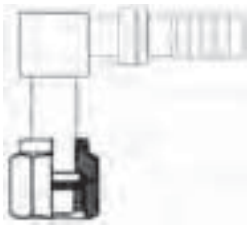

Descriptive #	Product #	SAP #	Hose Size ID		Thread Size	Drop (D)		Cut-Off (R)		Valve (V)	
			in.	mm		in.	mm	in.	mm	in.	mm
GC-OTF90B-0808	54610-0808	20306912	13/32	10.30	3/4-16	0.91	23	2.32	59		
GC-OTF90B-1010	54610-1010	20306913	1/2	12.70	7/8-14	0.94	24	2.32	59		
GC-OTF90B-1210	54610-1210	20306914	5/8	15.90	7/8-14	0.94	24	2.32	59		

## O-Ring Tube

Female | Swivel | 180° Elbow



Descriptive #	Product #	SAP #	Hose Size ID		Thread Size	Drop (D)		Cut-Off (R)		Valve (V)	
			in.	mm		in.	mm	in.	mm	in.	mm
GC-OTF180-0606	54615-0606	20307159	5/16	7.90	5/8-18	1.97	50	2.48	63		
GC-OTF180-0808	54615-0808	20307160	13/32	10.30	3/4-16	2.36	60	2.48	63		
GC-OTF180-1212	54615-1212	20307161	5/8	15.90	1 1/16-14	3.15	80	3.50	89		

## O-Ring Tube

Female | Swivel | R12 Valve



Drawing has R134a Valve  
Fittings have R12 Valve

Descriptive #	Product #	SAP #	Hose Size ID		Thread Size	Drop (D)		Cut-Off (R)		Valve (V)	
			in.	mm		in.	mm	in.	mm	in.	mm
GC-OTF12V-0606	54650-0606	20307162	5/16	7.90	5/8-18			1.42	36	1/4	6.35
GC-OTF12V-0808	54650-0808	20307163	13/32	10.30	3/4-16			1.57	40	1/4	6.35
GC-OTF12V-1010	54650-1010	20307164	1/2	12.70	7/8-14			1.97	50	1/4	6.35



“GC” Cool Clip® Fittings – For use with GALAXY® G4890 Hose

O-Ring Tube

Female | Swivel, R12 Valve | 90° Elbow

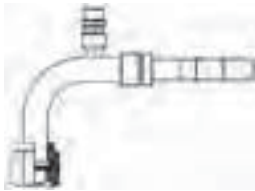

Drawing has R134a Valve  
Fittings have R12 Valve

Descriptive #	Product #	SAP #	Hose Size ID		Thread Size	Drop (D)		Cut-Off (R)		Valve (V)	
			in.	mm		in.	mm	in.	mm	in.	mm
GC-OTF12V90-0606	54655-0606	20306915	5/16	7.90	5/8-18	1.26	32	1.46	37	1/4	6.35
GC-OTF12V90-0808	54655-0808	20306916	13/32	10.30	3/4-16	1.42	36	1.77	45	1/4	6.35
GC-OTF12V90-1010	54655-1010	20306917	1/2	12.70	7/8-14	1.65	42	2.17	55	1/4	6.35
GC-OTF12V90-1210	54655-1210	20306918	5/8	15.90	7/8-14	1.50	38	1.85	47	1/4	6.35

O-Ring Tube

Female | Swivel | R134a Valve



Descriptive #	Product #	SAP #	Hose Size ID		Thread Size	Drop (D)		Cut-Off (R)		Valve (V)	
			in.	mm		in.	mm	in.	mm	in.	mm
GC-OTF134V-0606	54660-0606	20306919	5/16	7.90	5/8-18			1.42	36	0.63	16
GC-OTF134V-0808	54660-0808	20306920	13/32	10.30	3/4-16			1.57	40	0.63	16
GC-OTF134V-1010	54660-1010	20306921	1/2	12.70	7/8-14			1.97	50	0.51	13
GC-OTF134V-1210	54660-1210	20306922	5/8	15.90	7/8-14			1.97	50	0.51	13
GC-OTF134V-1212	54660-1212	20307165	5/8	15.90	1 1/16-14			2.09	53	0.51	13
GC-OTF134VHS-1010	54675-1010	20307172	1/2	12.70	7/8-14			1.97	50	0.63	16

O-Ring Tube

Female | Swivel | R134a Valve | 45° Elbow



Descriptive #	Product #	SAP #	Hose Size ID		Thread Size	Drop (D)		Cut-Off (R)		Valve (V)	
			in.	mm		in.	mm	in.	mm	in.	mm
GC-OTF134V45-0606	54663-0606	20307166	5/16	7.90	5/8-18	0.55	14	1.34	34	0.63	16
GC-OTF134V45-0808	54663-0808	20307167	13/32	10.30	3/4-16	0.59	15	1.38	35	0.63	16
GC-OTF134V45-1010	54663-1010	20307168	1/2	12.70	7/8-14	0.67	17	1.42	36	0.51	13
GC-OTF134V45-1210	54663-1210	20306923	5/8	15.90	7/8-14	0.67	17	1.42	36	0.51	13
GC-OTF134V45-1212	54663-1212	20307169	5/8	15.90	1 1/16-14	0.94	24	2.13	54	0.51	13

O-Ring Tube

Female, Swivel | R134a Valve | 90° Elbow

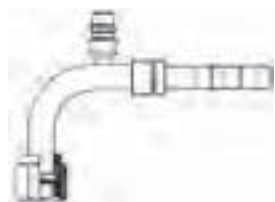

Descriptive #	Product #	SAP #	Hose Size ID		Thread Size	Drop (D)		Cut-Off (R)		Valve (V)	
			in.	mm		in.	mm	in.	mm	in.	mm
GC-OTF134V90-0606	54665-0606	20306924	5/16	7.90	5/8-18	1.26	32	1.46	37	0.63	16
GC-OTF134V90-0806	54665-0806	20307170	13/32	10.30	5/8-18	1.26	32	1.46	37	0.63	16
GC-OTF134V90-0808	54665-0808	20306925	13/32	10.30	3/4-16	1.42	36	1.77	45	0.63	16
GC-OTF134V90-1010	54665-1010	20306926	1/2	12.70	7/8-14	1.65	42	2.17	55	0.51	13
GC-OTF134V90-1210	54665-1210	20306927	5/8	15.90	7/8-14	1.65	42	2.17	55	0.51	13
GC-OTF134V90-1212	54665-1212	20307171	5/8	15.90	1 1/16-14	1.77	45	2.40	61	0.51	13

“GC” Cool Clip® Fittings - For use with GALAXY® G4890 Hose

## O-Ring Tube

Male | Swivel



Descriptive #	Product #	SAP #	Hose Size ID		Thread Size	Drop (D)		Cut-Off (R)		Valve (V)	
			in.	mm		in.	mm	in.	mm	in.	mm
GC-OTM-0606	54700-0606	20306928	5/16	7.90	5/8-18			1.50	38		
GC-OTM-0607	54700-0607	20306929	5/16	7.90	11/16-16			1.50	38		
GC-OTM-0608	54700-0608	20306930	5/16	7.90	3/4-18			1.54	39		
GC-OTM-0806	54700-0806	20307173	13/32	10.30	5/8-18			1.54	39		
GC-OTM-0808	54700-0808	20306931	13/32	10.30	3/4-18			2.09	53		
GC-OTM-1010	54700-1010	20306932	1/2	12.70	7/8-18			2.17	55		
GC-OTM-1012	54700-1012	20306933	1/2	12.70	1 1/16-16			2.17	55		
GC-OTM-1210	54700-1210	20306934	5/8	15.90	7/8-18			2.17	55		
GC-OTM-1212	54700-1212	20306935	5/8	15.90	1 1/16-16			2.40	61		

## O-Ring Tube

Male | Swivel | 45° Elbow



Descriptive #	Product #	SAP #	Hose Size ID		Thread Size	Drop (D)		Cut-Off (R)		Valve (V)	
			in.	mm		in.	mm	in.	mm	in.	mm
GC-OTM45-0606	54703-0606	20306936	5/16	7.90	5/8-18	0.87	22	1.14	29		
GC-OTM45-0608	54703-0608	20307174	5/16	7.90	3/4-18	0.87	22	1.14	29		
GC-OTM45-0806	54703-0806	20307175	13/32	10.30	5/8-18	0.87	22	1.14	29		
GC-OTM45-0808	54703-0808	20306937	13/32	10.30	3/4-18	0.98	25	1.42	36		
GC-OTM45-1010	54703-1010	20306938	1/2	12.70	7/8-18	1.06	27	1.65	42		
GC-OTM45-1210	54703-1210	20306939	5/8	15.90	7/8-18	1.18	30	1.81	46		
GC-OTM45-1212	54703-1212	20306940	5/8	15.90	1 1/16-16	1.18	30	1.81	46		

## O-Ring Tube

Male | Swivel | 90° Elbow

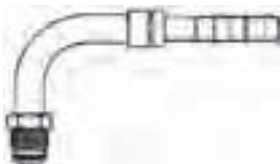

Descriptive #	Product #	SAP #	Hose Size ID		Thread Size	Drop (D)		Cut-Off (R)		Valve (V)	
			in.	mm		in.	mm	in.	mm	in.	mm
GC-OTM90-0606	54705-0606	20306941	5/16	7.90	5/8-18	1.46	37	1.38	35		
GC-OTM90-0608	54705-0608	20306942	5/16	7.90	3/4-18	1.46	37	1.38	35		
GC-OTM90-0806	54705-0806	20306943	13/32	10.30	5/8-18	1.46	37	1.38	35		
GC-OTM90-0808	54705-0808	20306944	13/32	10.30	3/4-18	1.77	45	1.69	43		
GC-OTM90-1010	54705-1010	20306945	1/2	12.70	7/8-18	2.05	52	2.01	51		
GC-OTM90-1012	54705-1012	20306946	1/2	12.70	1 1/16-16	2.05	52	2.01	51		
GC-OTM90-1210	54705-1210	20306947	5/8	15.90	7/8-18	2.05	52	2.01	51		
GC-OTM90-1212	54705-1212	20306948	5/8	15.90	1 1/16-16	2.36	60	2.24	57		

“GC” Cool Clip® Fittings – For use with GALAXY® G4890 Hose

## O-Ring Tube

Male | Swivel | Long Pilot



Descriptive #	Product #	SAP #	Hose Size ID		Thread Size	Drop (D)		Cut-Off (R)		Valve (V)	
			in.	mm		in.	mm	in.	mm	in.	mm
GC-OTMLP-0606	54720-0606	20307176	5/16	7.90	5/8-18			1.50	38		
GC-OTMLP-0808	54720-0808	20307177	13/32	10.30	3/4-18			2.09	53		
GC-OTMLP-1010	54720-1010	20307178	1/2	12.70	7/8-18			2.17	55		
GC-OTMLP-1210	54720-1210	20307179	5/8	15.90	7/8-18			2.17	55		

## O-Ring Tube

Male | Swivel | R134a Valve



Descriptive #	Product #	SAP #	Hose Size ID		Thread Size	Drop (D)		Cut-Off (R)		Valve (V)	
			in.	mm		in.	mm	in.	mm	in.	mm
GC-OTM134V-0606	54730-0606	20307180	5/16	7.90	5/8-18			1.42	36	0.63	16
GC-OTM134V-0808	54730-0808	20307181	13/32	10.30	3/4-18			1.57	40	0.63	16
GC-OTM134V-1010	54730-1010	20307182	1/2	12.70	7/8-18			1.97	50	0.51	13
GC-OTM134V-1210	54730-1210	20306949	5/8	15.90	7/8-18			2.09	53	0.51	13
GC-OTM134V-1212	54730-1212	20307183	5/8	15.90	1 1/16-16			2.09	53	0.51	13

## O-Ring Tube

Male | Swivel | R134a Valve | 90° Elbow

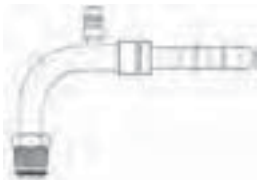

Descriptive #	Product #	SAP #	Hose Size ID		Thread Size	Drop (D)		Cut-Off (R)		Valve (V)	
			in.	mm		in.	mm	in.	mm	in.	mm
GC-OTM134V90-1010	54735-1010	20307184	1/2	12.70	7/8-18	2.05	52	2.01	51	0.51	13
GC-OTM134V90-1210	54735-1210	20306950	5/8	15.90	7/8-18	2.05	52	2.01	51	0.51	13

## SAE 45° Flare

Female | Swivel



Descriptive #	Product #	SAP #	Hose Size ID		Thread Size	Drop (D)		Cut-Off (R)		Valve (V)	
			in.	mm		in.	mm	in.	mm	in.	mm
GC-SFFX-0606	54760-0606	20306951	5/16	7.90	5/8-18			1.73	44		
GC-SFFX-0608	54760-0608	20306952	5/16	7.90	3/4-16			1.73	44		
GC-SFFX-0806	54760-0806	20307185	13/32	10.30	5/8-18			2.13	54		
GC-SFFX-0808	54760-0808	20306953	13/32	10.30	3/4-16			2.13	54		
GC-SFFX-1008	54760-1008	20307186	1/2	12.70	3/4-16			2.13	54		
GC-SFFX-1010	54760-1010	20306954	1/2	12.70	7/8-14			2.32	59		
GC-SFFX-1210	54760-1210	20306955	5/8	15.90	7/8-14			2.32	59		
GC-SFFX-1212	54760-1212	20306956	5/8	15.90	1 1/16-14			2.52	64		

“GC” Cool Clip® Fittings - For use with GALAXY® G4890 Hose

## SAE 45° Flare

Female | Swivel | 45° Elbow



Descriptive #	Product #	SAP #	Hose Size ID		Thread Size	Drop (D)		Cut-Off (R)		Valve (V)	
			in.	mm		in.	mm	in.	mm	in.	mm
GC-SFFX45-0606	54763-0606	20306957	5/16	7.90	5/8-18	0.79	20	2.52	64		
GC-SFFX45-0608	54763-0608	20306958	5/16	7.90	3/4-16	0.79	20	2.52	64		
GC-SFFX45-0806	54763-0806	20307187	13/32	10.30	5/8-18	0.79	20	2.52	64		
GC-SFFX45-0808	54763-0808	20306959	13/32	10.30	3/4-16	0.79	20	2.72	69		
GC-SFFX45-1008	54763-1008	20307188	1/2	12.70	3/4-16	0.79	20	2.72	69		
GC-SFFX45-1010	54763-1010	20306960	1/2	12.70	7/8-14	0.87	22	2.72	69		
GC-SFFX45-1210	54763-1210	20306961	5/8	15.90	7/8-14	0.87	22	2.72	69		
GC-SFFX45-1212	54763-1212	20306962	5/8	15.90	1 1/16-14	0.87	22	2.72	69		

## SAE 45° Flare

Female | Swivel | 90° Elbow

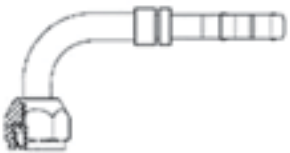

Descriptive #	Product #	SAP #	Hose Size ID		Thread Size	Drop (D)		Cut-Off (R)		Valve (V)	
			in.	mm		in.	mm	in.	mm	in.	mm
GC-SFFX90-0606	54765-0606	20306963	5/16	7.90	5/8-18	1.18	30	1.73	44		
GC-SFFX90-0608	54765-0608	20306964	5/16	7.90	3/4-16	1.18	30	1.73	44		
GC-SFFX90-0806	54765-0806	20307189	13/32	10.30	5/8-18	1.18	30	1.73	44		
GC-SFFX90-0808	54765-0808	20306965	13/32	10.30	3/4-16	1.77	45	1.73	44		
GC-SFFX90-1008	54765-1008	20307190	1/2	12.70	3/4-16	1.77	45	1.73	44		
GC-SFFX90-1010	54765-1010	20306966	1/2	12.70	7/8-14	1.77	45	2.13	54		
GC-SFFX90-1210	54765-1210	20306967	5/8	15.90	7/8-14	1.77	45	2.13	54		
GC-SFFX90-1212	54765-1212	20306968	5/8	15.90	1 1/16-14	1.77	45	2.13	54		

## SAE 45° Flare

Male

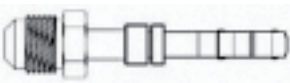

Descriptive #	Product #	SAP #	Hose Size ID		Thread Size	Drop (D)		Cut-Off (R)		Valve (V)	
			in.	mm		in.	mm	in.	mm	in.	mm
GC-SFM-0606A	54780-0606	20306969	5/16	7.90	5/8-18			1.73	44		
GC-SFM-0808A	54780-0808	20306970	13/32	10.30	3/4-16			1.73	44		
GC-SFM-1010A	54780-1010	20306971	1/2	12.70	7/8-14			1.85	47		
GC-SFM-1212A	54780-1212	20306972	5/8	15.90	1 1/16-14			2.09	53		

“GC” Cool Clip® Fittings - For use with GALAXY® G4890 Hose

## SAE 45° Flare

Male | 45° Elbow



Descriptive #	Product #	SAP #	Hose Size ID		Thread Size	Drop (D)		Cut-Off (R)		Valve (V)	
			in.	mm		in.	mm	in.	mm	in.	mm
GC-SFM45-0606A	54783-0606	20306973	5/16	7.90	5/8-18	0.75	19	1.73	44		
GC-SFM45-0808A	54783-0808	20306974	13/32	10.30	3/4-16	0.94	24	1.73	44		
GC-SFM45-1010A	54783-1010	20306975	1/2	12.70	7/8-14	1.26	32	2.13	54		
GC-SFM45-1212A	54783-1212	20306976	5/8	15.90	1 1/16-14	1.38	35	2.13	54		

## SAE 45° Flare

Male | 90° Elbow

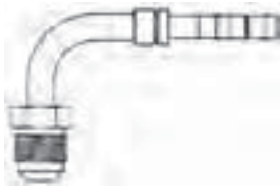

Descriptive #	Product #	SAP #	Hose Size ID		Thread Size	Drop (D)		Cut-Off (R)		Valve (V)	
			in.	mm		in.	mm	in.	mm	in.	mm
GC-SFM90-0606A	54785-0606	20306977	5/16	7.90	5/8-18	1.18	30	1.73	44		
GC-SFM90-0808A	54785-0808	20306978	13/32	10.30	3/4-16	1.77	45	1.73	44		
GC-SFM90-1010A	54785-1010	20306979	1/2	12.70	7/8-14	1.77	45	2.13	54		
GC-SFM90-1212A	54785-1212	20306980	5/8	15.90	1 1/16-14	1.77	45	2.13	54		

### A/C Adapters

## O-Ring Tube Compressor Female to O-Ring Insert

Male | 90° Elbow | with R134a Valve

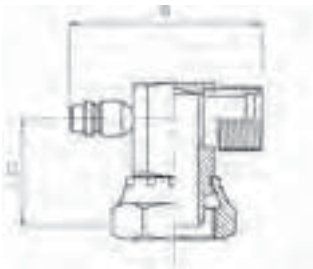

Descriptive #	Product #	SAP #	Thread Size OTCF	Thread Size OIM
AC-OTCF10-OIM08-90-134V	50900-1008	20307079	1-14	3/4-16
AC-OTCF10-OIM10-90-134V	50900-1010	20307080	1-14	7/8-14

## O-Ring Tube Female to O-Ring Insert

Male | with R12 Valve



Drawing has R134a Valve  
Fittings have R12 Valve

Descriptive #	Product #	SAP #	Thread Size OTCF	Thread Size OIM
AC-OTF06-OIM06-12V	50910-0606	20307081	5/8-18	5/8-18
AC-OTF08-OIM08-12V	50910-0808	20307082	3/4-16	3/4-16
AC-OTF10-OIM10-12V	50910-1010	20307083	7/8-14	7/8-14
AC-OTF12-OIM12-12V	50910-1212	20307084	1 1/16-14	1 1/16-14

## A/C Adapters

## O-Ring Tube Female to O-Ring Insert

Male | 90° Elbow | with R12 Valve

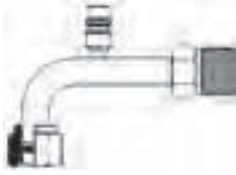

Drawing has R134a Valve  
Fittings have R12 Valve

Descriptive #	Product #	SAP #	Thread Size OTCF	Thread Size OIM
AC-OTF06-OIM06-90-12V	50915-0606	20307085	5/8-18	5/8-18
AC-OTF08-OIM08-90-12V	50915-0808	20307086	3/4-16	3/4-16
AC-OTF10-OIM10-90-12V	50915-1010	20307087	7/8-14	7/8-14
AC-OTF12-OIM12-90-12V	50915-1212	20307088	1 1/16-14	1 1/16-14

## O-Ring Tube Female to O-Ring Insert

Male | with R134a Valve

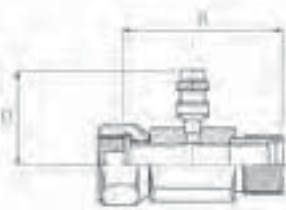

Descriptive #	Product #	SAP #	Thread Size OTCF	Thread Size OIM
AC-OTF06-OIM06-134V	50920-0606	20306798	5/8-18	5/8-18
AC-OTF08-OIM08-134V	50920-0808	20306799	3/4-16	3/4-16
AC-OTF10-OIM10-134V	50920-1010	20306800	7/8-14	7/8-14
AC-OTF12-OIM12-134V	50920-1212	20306801	1 1/16-14	1 1/16-14

## O-Ring Tube Female to O-Ring Insert

Male | 90° Elbow | with R134a Valve

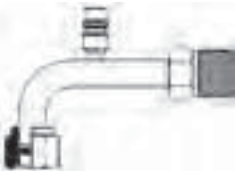

Descriptive #	Product #	SAP #	Thread Size OTCF	Thread Size OIM
AC-OTF06-OIM06-90-134V	50925-0606	20306802	5/8-18	5/8-18
AC-OTF08-OIM08-90-134V	50925-0808	20306803	3/4-16	3/4-16
AC-OTF10-OIM10-90-134V	50925-1010	20306804	7/8-14	7/8-14
AC-OTF12-OIM12-90-134V	50925-1212	20306805	1 1/16-14	1 1/16-14

## "AC" Crimp &amp; "GC" Cool Clip® Fitting Accessories

## Flareless Tube Nuts



Descriptive #	Product #	SAP #	Thread Size	Tube OD
				in.
AC-FTN-0006	50250-0006	20306632	5/8-18	3/8
AC-FTN-0008	50250-0008	20306633	3/4-16	1/2
AC-FTN-0010	50250-0010	20306634	7/8-14	5/8
AC-FTN-0012	50250-0012	20306635	1 1/16-14	3/4

“AC” Crimp & “GC” Cool Clip® Fitting Accessories

## Flareless Tube Sleeves



Descriptive #	Product #	SAP #	Tube OD	
			in.	
AC-FTS-0006	50255-0006	20306636	3/8	
AC-FTS-0008	50255-0008	20306637	1/2	
AC-FTS-0010	50255-0010	20306638	5/8	
AC-FTS-0012	50255-0012	20306639	3/4	

## Flareless Tube Sleeves

Metric



Descriptive #	Product #	SAP #	Tube OD	
			mm	
AC-FTSM-0008	50260-0008	20306640	8.0	
AC-FTSM-0012	50260-0012	20306641	12.0	
AC-FTSM-0015	50260-0015	20306642	14.5	

## Inline Orifice Tubes

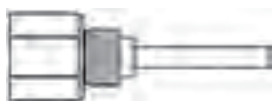

Descriptive #	Product #	SAP #	Orifice Tube OD		Orifice Tube Length		Description
			in.	mm	in.	mm	
			AC-ILOTORA-0057	50401-0057	20306995	.057	
AC-ILOTRED-0062	50401-0062	20306996	.062	1.6	3.50	88.9	Inline Orifice Tube, Ford, Red
AC-ILOTBLU-0072	50401-0072	20306997	.072	1.8	3.50	88.9	Inline Orifice Tube, Ford, Blue
AC-ILOTBLK-0072	50402-0072	20306998	.072	1.8	3.50	88.9	Inline Orifice Tube, GM, Black
AC-ILOTWHI-0072	50403-0072	20306999	.072	1.8	3.50	88.9	Inline Orifice Tube, GM, White

## O-Ring

for Ford Spring Lock



Descriptive #	Product #	SAP #	O-Ring ID	
			in.	mm
GC-OFSL-0006	54450-0006	20306556	3/8	9.5
GC-OFSL-0008	54450-0008	20306557	1/2	12.7
GC-OFSL-0010	54450-0010	20306558	5/8	15.9
GC-OFSL-0012	54450-0012	20306559	3/4	19.1

## "AC" Crimp &amp; "GC" Cool Clip® Fitting Accessories

## O-Ring

for Switch



Descriptive #	Product #	SAP #	O-Ring ID	
			in.	mm
GC-OSWCH-0006	54455-0006	20307200	3/8	9.5

## O-Ring

for Tube Fittings



Descriptive #	Product #	SAP #	O-Ring ID		O-Ring Thickness	
			in.	mm	in.	mm
AC-OTUBE-0006	50460-0006	20306552	.30	7.6	.07	1.8
AC-OTUBE-0008	50460-0008	20306553	.43	10.9	.07	1.8
AC-OTUBE-0010	50460-0010	20306554	.55	14.0	.07	1.8
AC-OTUBE-0012	50460-0012	20306555	.68	17.3	.07	1.8

## Sealing Washers



Descriptive #	Product #	SAP #	ID	Product Description
				in.
AC-SWA-0012	50800-0012	20306787	3/4	Sealing Washer, Accumulator
AC-SWCN-0010	50803-0010	20306788	5/8	Sealing Washer, Compressor, Narrow
AC-SWCN-0012	50803-0012	20306789	3/4	Sealing Washer, Compressor, Narrow
AC-SWCW-0010	50805-0010	20306790	5/8	Sealing Washer, Compressor, Wide

## Valve Adapters

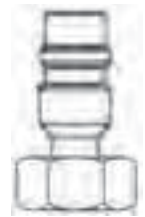

Descriptive #	Product #	SAP #	R12	R134a	Product Description
			Thread Size		
			in.	mm	
AC-VA12V3/16-134V16	50820-0001	20306791	3/8-24	16	Converts R12 to R134a valve
AC-VA12V1/4-134V13	50820-0002	20306792	7/16-20	13	Converts R12 to R134a valve
AC-VA12V1/4-134V16	50820-0003	20306793	7/16-20	16	Converts R12 to R134a valve

## Valve Caps



Descriptive #	Product #	SAP #	Valve Style	
			in.	in. mm
AC-VC12V-0001	50830-0001	20306794	R12	1/4
AC-VC134VHS-0002	50830-0002	20306795	R134a H.S.	16
AC-VC134VLS-0003	50830-0003	20306796	R134a L.S.	13



“AC” Crimp & “GC” Cool Clip® Fitting Accessories

## Valve Core



Descriptive #	Product #	SAP #	Thread Size
AC-VCORE-0001	50835-0001	20306797	.210x36

## Metal Clip



Descriptive #	Product #	SAP #	Hose ID	
			in.	mm
GC-CLIP-0006	54850-0006	20306981	5/16	7.9
GC-CLIP-0008	54850-0008	20306982	13/32	10.3
GC-CLIP-0010	54850-0010	20306983	1/2	12.7
GC-CLIP-0012	54850-0012	20306984	5/8	15.9

## Plastic Clip Holder



Descriptive #	Product #	SAP #	Hose ID	
			in.	mm
GC-CLIPHLDR-0006	54855-0006	20306985	5/16	7.9
GC-CLIPHLDR-0008	54855-0008	20306986	13/32	10.3
GC-CLIPHLDR-0010	54855-0010	20306987	1/2	12.7
GC-CLIPHLDR-0012	54855-0012	20306988	5/8	15.9

## Clip Pliers

A/C Fitting Accessories



Descriptive #	Product #	SAP #	Product Description
GC-PLIERS-0001	54860-0001	20306989	Clip Pliers for assembly of Cool Clip® Fittings

## Hose Cutting Tool & Replacement Blades

A/C Fitting Accessories



Descriptive #	Product #	SAP #	Product Description
65090 HCT	65090	20038629	Hose Cutting Tool for G4890 Hose
65091 HCTRB	65091	20052606	Hose Cutting Tool Replacement Blades - 2/Pkg

## Uni-Crimp™ and Dual-Grip™ Fitting Ferrules

This section lists dimensions and attributes for 11 Uni-Crimp™ and 2 Dual-Grip™ style ferrules.

The Uni-Crimp™ style ferrules can be non-skive or external skive, depending on the hose family. Uni-Crimp™ ferrules are to be used only with Uni-Crimp™ style stems.

The Dual-Grip™ style ferrules are external and internal skive and are to be used only with Dual-Grip™ style stems.

### Uni-Crimp™ UCF1 Ferrule



Descriptive/ Product #	SAP #	Hose Size ID		Ferrule Inside Diameter (A)		Ferrule Outside Diameter (B)		Ferrule Length (L)	
		in.	mm	in.	mm	in.	mm	in.	mm
UCF1-03	20242266	3/16	4.8	0.449	431.6	0.669	17.0	0.945	24.0

### Uni-Crimp™ UCF2 Ferrule

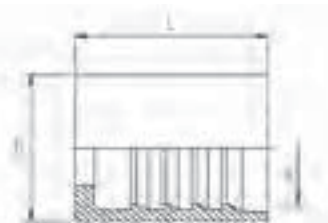

Descriptive/ Product #	SAP #	Hose Size ID		Ferrule Inside Diameter (A)		Ferrule Outside Diameter (B)		Ferrule Length (L)	
		in.	mm	in.	mm	in.	mm	in.	mm
UCF2-03	20242268	3/16	4.8	0.493	12.5	0.750	19.1	0.940	23.9
UCF2-04	20242276	1/4	6.4	0.551	14.0	0.827	21.0	1.035	26.3
UCF2-05	20242272	5/16	7.9	0.618	15.7	0.866	22.0	1.043	26.5
UCF2-06	20242273	3/8	9.5	0.713	18.1	0.984	25.0	1.122	28.5
UCF2-08	20242270	1/2	12.7	0.843	21.4	1.142	29.0	1.366	34.7
UCF2-08S	20575005	1/2	12.7	0.843	21.4	1.142	29.0	1.366	34.7
UCF2-10	20242275	5/8	15.9	0.984	25.0	1.260	32.0	1.476	37.5
UCF2-12	20242264	3/4	19.0	1.134	28.8	1.417	36.0	1.624	41.2
UCF2-16	20242267	1	25.4	1.437	36.5	1.772	45.0	1.874	47.6
UCF2-32	20309909	2	50.8	2.643	67.1	3.228	82.0	2.953	75.0

### Uni-Crimp™ UCF3 Ferrule

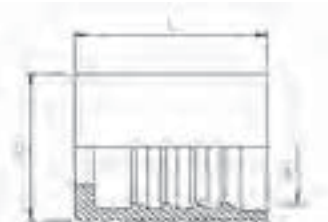

Descriptive/ Product #	SAP #	Hose Size ID		Ferrule Inside Diameter (A)		Ferrule Outside Diameter (B)		Ferrule Length (L)	
		in.	mm	in.	mm	in.	mm	in.	mm
UCF3-04	20241234	1/4	6.4	0.630	16.0	0.866	22.0	1.035	26.3
UCF3-06	20241235	3/8	9.5	0.724	18.4	0.984	25.0	1.122	28.5
UCF3-08	20671286	1/2	12.7	0.843	21.4	1.142	29.0	1.366	34.7
UCF3-12	20668542	3/8	19.0	1.172	29.8	1.457	37.0	1.642	41.7

## Uni-Crimp™ UCF4 Ferrule

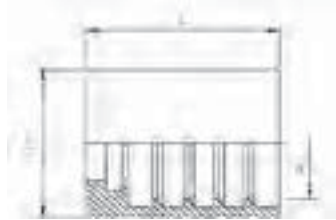

Descriptive/ Product #	SAP #	Hose Size ID		Ferrule Inside Diameter (A)		Ferrule Outside Diameter (B)		Ferrule Length (L)	
		in.	mm	in.	mm	in.	mm	in.	mm
UCF4-20	20241233	1/4	31.8	1.764	44.8	2.165	55.0	1.567	39.8

## Uni-Crimp™ UCF5 Ferrule

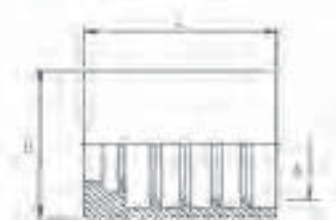

Descriptive/ Product #	SAP #	Hose Size ID		Ferrule Inside Diameter (A)		Ferrule Outside Diameter (B)		Ferrule Length (L)	
		in.	mm	in.	mm	in.	mm	in.	mm
UCF5-32	20350849	2	50.8	2.756	70.0	3.228	82.0	2.874	73.0

## Uni-Crimp™ UCF6 Ferrule

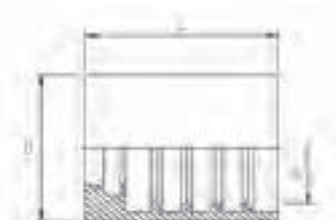

Descriptive/ Product #	SAP #	Hose Size ID		Ferrule Inside Diameter (A)		Ferrule Outside Diameter (B)		Ferrule Length (L)	
		in.	mm	in.	mm	in.	mm	in.	mm
UCF6-03	20288135	3/16	4.8	0.559	14.2	0.787	20.0	0.957	24.3
UCF6-04	20242277	1/4	6.4	0.638	16.2	0.840	21.3	1.035	26.3
UCF6-05	20241236	5/16	7.9	0.709	18.0	0.984	25.0	1.035	26.3
UCF6-06	20242282	3/8	9.5	0.823	20.9	0.984	25.0	1.071	27.2
UCF6-08	20242269	1/2	12.7	0.961	24.4	1.142	29.0	1.291	32.8
UCF6-10	20283401	5/8	15.9	1.091	27.7	1.339	34.0	1.402	35.6
UCF6-12	20242279	3/4	19.0	1.252	31.8	1.496	38.0	1.520	38.6
UCF6-12S	20777819	3/4	19.0	1.252	31.8	1.496	38.0	1.520	38.6
UCF6-16	20242280	1	25.4	1.654	42.0	1.969	50.0	1.787	45.4
UCF6-16S	20777819	1	25.4	1.654	42.0	1.939	49.3	1.787	45.4
UCF6-20	20242278	1/4	31.8	1.811	46.0	2.008	51.0	1.929	49.0
UCF6-20S	20676945	1/4	31.8	1.811	46.0	2.008	51.0	1.929	49.0
UCF6-24	20242274	1/2	38.1	2.138	54.3	2.374	60.3	2.205	56.0
UCF6-32	20242271	2	50.8	2.720	69.1	2.996	76.1	2.717	69.0
UCF6-32S	20672344	2	50.8	2.720	69.1	2.996	76.1	2.717	69.0
UCF6-40	20242263	2 1/2	63.5	3.189	81.0	3.500	88.9	3.347	85.0

## Uni-Crimp™ UCF7 Ferrule

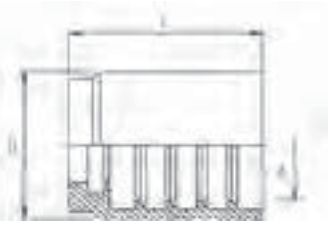

Descriptive/ Product #	SAP #	Hose Size ID		Ferrule Inside Diameter (A)		Ferrule Outside Diameter (B)		Ferrule Length (L)	
		in.	mm	in.	mm	in.	mm	in.	mm
UCF7-08	20263935	1/2	12.7	0.965	24.511	1.339	34.0	1.355	34.4
UCF7-16	20241237	1	25.4	1.535	39.0	1.969	50.0	1.866	47.4
UCF7-20	20318245	1¼	31.8	1.949	49.5	2.402	61.0	1.969	50.0

## Uni-Crimp™ UCF8 Ferrule

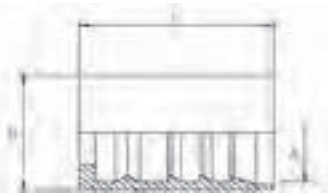

Descriptive/ Product #	SAP #	Hose Size ID		Ferrule Inside Diameter (A)		Ferrule Outside Diameter (B)		Ferrule Length (L)	
		in.	mm	in.	mm	in.	mm	in.	mm
UCF8-32	20289652	2	50.8	2.413	61.3	2.795	71.0	2.505	63.6

## Uni-Crimp™ UCF9 Ferrule

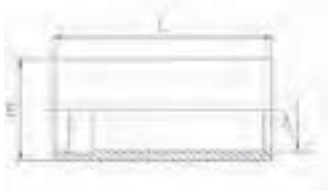

Descriptive/ Product #	SAP #	Hose Size ID		Ferrule Inside Diameter (A)		Ferrule Outside Diameter (B)		Ferrule Length (L)	
		in.	mm	in.	mm	in.	mm	in.	mm
UCF9-03	20318605	3/16	4.8	0.394	10.0	0.551	14.0	0.982	24.9
UCF9-04	20303300	1/4	6.4	0.433	11.0	0.591	15.0	1.142	29.0
UCF9-04S	20540398	1/4	6.4	0.433	11.0	0.591	15.0	1.142	29.0
UCF9-05	20303301	5/16	7.9	0.512	13.0	0.669	17.0	1.181	30.0
UCF9-05S	20540399	5/16	7.9	0.512	13.0	0.669	17.0	1.181	30.0
UCF9-06	20303302	3/8	9.5	0.669	17.0	0.866	22.0	1.220	31.0
UCF9-06S	20540680	3/8	9.5	0.669	17.0	0.866	22.0	1.220	31.0
UCF9-08	20303303	1/2	12.7	0.787	20.0	0.984	25.0	1.339	34.0
UCF9-08S	20540681	1/2	12.7	0.787	20.0	0.984	25.0	1.339	34.0
UCF9-10	20303304	5/8	15.9	0.984	25.0	1.181	30.0	1.417	36.0
UCF9-10S	20540682	5/8	15.9	0.984	25.0	1.181	30.0	1.417	36.0
UCF9-12	20303305	3/4	19.0	1.173	29.8	1.378	35.0	1.575	40.0
UCF9-12S	20540683	3/4	19.0	1.173	29.8	1.378	35.0	1.575	40.0
UCF9-16	20303306	1	25.4	1.449	36.8	1.654	42.0	1.811	46.0
UCF9-16S	20540684	1	25.4	1.449	36.8	1.654	42.0	1.811	46.0

## Uni-Crimp™ UCF10 Ferrule

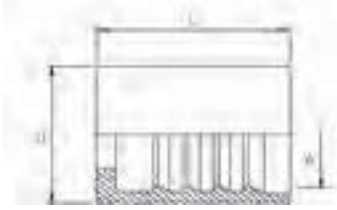

Descriptive/ Product #	SAP #	Hose Size ID		Ferrule Inside Diameter (A)		Ferrule Outside Diameter (B)		Ferrule Length (L)	
		in.	mm	in.	mm	in.	mm	in.	mm
UCF10-04	20646659	1/4	6.4	0.499	12.7	0.747	19.0	1.040	26.4
UCF10-08	20357071	1/2	12.7	0.824	20.9	1.083	27.5	1.291	32.8
UCF10-10	20676729	5/8	15.9	1.028	26.1	1.339	34.0	1.402	35.6
UCF10-12	20676720	3/4	19.0	1.189	30.2	1.496	38.0	1.520	38.6
UCF10-16	20675424	1	25.4	1.560	39.6	2.008	51.0	1.780	45.2

## Uni-Crimp™ UCF11 Ferrule

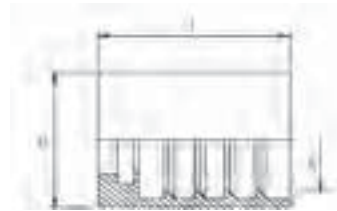

Descriptive/ Product #	SAP #	Hose Size ID		Ferrule Inside Diameter (A)		Ferrule Outside Diameter (B)		Ferrule Length (L)	
		in.	mm	in.	mm	in.	mm	in.	mm
UCF11-04	20369170	1/4	6.4	0.606	15.4	0.866	22.0	1.035	26.3
UCF11-06	20706519	1/4	6.4	0.681	17.3	0.967	24.6	1.180	30.0

## Dual-Grip™ DGF1 Ferrule

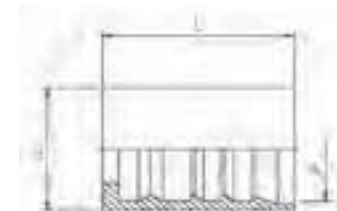

Descriptive/ Product #	SAP #	Hose Size ID		Ferrule Inside Diameter (A)		Ferrule Outside Diameter (B)		Ferrule Length (L)	
		in.	mm	in.	mm	in.	mm	in.	mm
DGF1-12	20242262	3/4	19.0	1.18	30.0	1.46	37.1	2.36	59.9
DGF1-16	20242265	1	25.4	1.47	37.3	1.81	46.0	2.93	74.4
DGF1-20	20241238	1¼	31.8	1.74	44.2	2.17	55.1	3.46	87.9
DGF1-24	20254315	1½	38.1	2.02	51.3	2.44	62.0	3.70	94.0
DGF1-32	20254316	2	50.8	2.60	66.0	3.07	78.0	3.90	99.0

## Dual-Grip™ DGF2 Ferrule

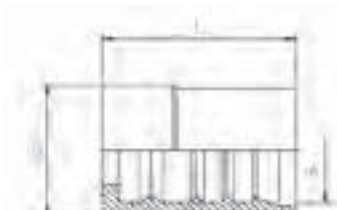

Descriptive/ Product #	SAP #	Hose Size ID		Ferrule Inside Diameter (A)		Ferrule Outside Diameter (B)		Ferrule Length (L)	
		in.	mm	in.	mm	in.	mm	in.	mm
DGF2-20	20242260	1¼	31.8	1.95	49.5	2.43	61.7	3.46	87.9
DGF2-24	20242261	1½	38.1	2.20	55.9	2.72	69.1	3.70	94.0
DGF2-32	20241239	2	50.8	2.80	71.1	3.43	87.1	3.90	99.1

## Choosing the Correct Fittings

Choosing the correct Perma-Crimp™ fitting may be simply identifying the fitting to be replaced by measuring the fitting or in some other way, identifying its size and thread type. Care should be taken in using the correct fitting.

1. The correct fitting is chosen to match a replacement fitting and/or chosen on the basis of formal design and sound engineering practice.
2. Any questions or concerns involving fitting selection should be addressed with the local Sales Representative, Hydraulic Applications Group, or with our Customer Service Group at 800-235-4632.
3. Selecting the proper hose assembly – see assemblies section of this catalog. A helpful guide is the “S.T.A.M.P.E.D.” process, which requires the documentation of the following:

- S** Size – ID, OD and length of the assembly
- T** Temperature – Temperature of material conveyed and climatic conditions
- A** Application – Conditions of use including abrasion, flexing and routing
- M** Material – Type, concentration and composition
- P** Pressure – Includes surge or impulse pressure
- E** Ends – Style, type, orientation and attachment methods
- D** Delivery – Includes testing, quality and packaging requirements

In completing the “S.T.A.M.P.E.D.” process, “Ends” need to be further defined.

Thread Size	Drop Length
Thread Type	Hose Type
Male or Female	Hose Dash Size
Angle of Elbow	Hose Working Pressure

4. The Perma-Crimp™ fitting is available in four styles including Ultra-Crimp™, Uni-Crimp™, Field-Grip™ or Dual-Grip™. Each fitting consists of a stem and a ferrule. The stem fits into the hose ID. The ferrule attaches the fitting to the hose cover. The stem has two functional ends. The first is the hose end, which is used to attach the fitting to the hose. The hose end must be compatible with the ID of the hose. The other end is the thread end, which is used to attach the assembly to another port in the hydraulic system. The thread end will be determined from the fitting being replaced or by measuring the port or threads being attached.
5. Temperature range is important in both hose and fitting selection. Hose temperature ranges are shown on page 44 of this catalog. In general, fittings will be comparable with hose temperature ranges with the exception of O-ring fittings, which are limited to 212°F (100°C).
6. Flange identification requires additional information. Code 61 Flanges, Code 62 Flanges and Caterpillar® Flanges are commonly used to connect large sizes of hose and tubing. Code 61 Flanges are commonly used in applications of 3,000-5,000 psi working pressure, while Code 62 Flanges can be used in applications up to 6,000 psi working pressure. Code 62 and Caterpillar® Flanges are similar in application but Caterpillar® Flanges have a thicker flange head and are frequently found on Caterpillar® equipment. Flanges are identified by measuring the port hole diameter, the longest bolt hole spacing and the flange head thickness.
7. It is possible to have a fitting rated at a lower working pressure than the hose. Keep working pressure in mind when selecting a fitting. The hose assembly can be rated no greater than the lowest pressure rating of either hose or fitting. Reference working pressure tables can be found on pages 36-41.

Note: Dimensions in the catalog are listed as approximate and for reference only. Dimensions are subject to change.

# Fitting Working Pressure Charts

## Maximum Recommended Working Pressure (psi)

Choose fittings carefully, considering the working pressure of both hose and fitting. The **maximum** working pressure of the hose assembly is the lesser of the **rated** working pressure of the hose **and** the fitting.

Working pressures shown on the page are not applicable for the Field-Grip™ reattachable fittings (FG-\*). Please contact Continental ContiTech Customer Service for the working pressure of the FG fittings.

Fitting Style	JIC 37° Flare Male Non-Swivel	JIC 37° Flare Female Swivel	NPTF Male Swivel	NPTF Male Non-Swivel	NPTF Female Swivel	NPSM Female Swivel	Code 61 Flange	Code 62 Flange	CAT® Flange	Straight Thread O-Ring Boss male	O-Ring Face Seal Female
<b>Thread Dash Size</b>											
-02											
-04	6000	6000	6000	6000	6000	6000				5000	6000
-05	6000	6000								5000	
-06	6000	6000	6000	6000	6000	6000				5000	6000
-08	5000	5000	5000	5000	5000	5000	5000	6000		4500	6000
-10	4000	4000					5000	6000		4000	6000
-12	4000	4000	2250	4000	2250	2250	5000	6000	6000	4000	6000
-14											
-16	4000	4000	2000	4000	2000	2000	5000	6000	6000	4000	6000
-20	3000	3000		3000	1625	1625	4000	6000	6000	3000	4000
-24	3000	3000		2500			3000	6000	6000		4000
-32	3000	3000		2500			3000	6000	6000		

Fitting Style	SAE 45° Flare Female Swivel	SAE J514 Flareless Tube Fitting	BSPP O-Ring Female Swivel	BSPT Male Non-Swivel	BSPP Male Non-Swivel	DIN 24 Light Female Swivel	DIN 24 Light Male	DIN 24 Heavy Female Swivel	DIN 24 Heavy Male	JIS 30° Flare Female Swivel	JIS 30° Flareless Female Swivel	Komatsu® 30° Metric Thread Female Swivel
<b>Thread Dash Size</b>												
-02												
-04	3000	5000	5800	5800	5800	3625	3625			5000	5000	5000
-05		5000				3625	3625	5800	5800			
-06	3000	4000	5800	5800	5800	3625	3625	5800	5800	5000	5000	5000
-08	3000	3500	5000	5000	5000	3625	3625	5800	5800	5000	5000	5000
-10	2750	2750	5000	5000	5000	3625	3625	5800	5800			
-12	2250	2250	4500	4500	4500	2320	2320	5800	5800	4000	4000	4000
-14												
-16	2000	2000	3500	3500	3500	2320	2320	5800	5800	3000	3000	3000
-20	1625	1625	2850	2850	2850	1450	1450	5800	5800	2500	2500	2500
-24	1250		2250	2250	2250	1450	1450	3625	3625	1500	1500	1500
-32	1125		1800	1800	1800	1450	1450	3625	3625	1500	1500	1500

Selection of the proper Continental ContiTech Brand fitting is essential to the proper operation and safe use of the hose assembly and related equipment. Inadequate attention to the selection of the proper fitting for the application can result in failure of the fitting which can cause serious bodily injury or property damage from spraying fluids or projectiles.

# Thread Reference Chart

Thread Type	02	03	04	05	06	08	10	12	14	15	16	18	20
JIC 37° Flare (SAE J514)		3/8-24	7/16-20	1/2-20	9/16-18	3/4-16	7/8-14	1 1/16-12	1 3/16-12		1 5/16-12		1 5/8-12
SAE 45° J512 Flare			7/16-20	1/2-20	5/8-18	3/4-16	7/8-14	1 1/16-14					
SAE 45° Inverted Flare		3/8-24	7/16-24	1/2-20	5/8-18	3/4-18	7/8-18						
NPTF	1/8-27		1/4-18		3/8-18	1/2-14		3/4-14			1-11 1/2		1 1/4-11 1/2
NPSM			1/4-18		3/8-18	1/2-14		3/4-14			1-11 1/2		1 1/4-11 1/2
NPMAPI											1-11 1/2		1 1/4-11 1/2
SAE J514 Flareless Tube Fittings			7/16-20	1/2-20	9/16-18	3/4-16	7/8-14	1 1/16-12			1 5/16-12		
O-Ring Face Seal (SAE J1453 ORS/ORFS)			9/16-18		11/16-16	13/16-16	1-14	1 3/16-12			1 7/16-12		1 11/16-12
O-Ring Boss Straight Thread (SAE J514)			7/16-20	1/2-20	9/16-18	3/4-16	7/8-14	1 1/16-12			1 5/16-12		1 5/8-12
BSPP (British Standard Pipe Parallel)			1/4-19		3/8-19	1/2-14	5/8-14	3/4-14			1-11		1 1/4-11
BSPT (British Standard Pipe Tapered)			1/4-19		3/8-19	1/2-14		3/4-14			1-11		
BSP Flat Seat (British Standard Pipe)					3/8-19	1/2-14		3/4-14					
JIS 30° (Parallel Pipe Threads)			1/4-19		3/8-19	1/2-14		3/4-14			1-11		1 1/4-11
Code 61 Flange (SAE J518) - Dia.						1.19		1.5			1.75		2
Code 62 Flange (SAE J518) - Dia.						1.25		1.63			1.87		2.13
Caterpillar® Flange - Dia.								1.63			1.87		2.13
Komatsu® Flange - Dia.							1.34						
Standpipe - OD						8mm	10mm	12mm		15mm	16mm	18mm	20mm
DIN 24° Light								12 x 1 1/2	14 x 1 1/2		16 x 1 1/2	18 x 1 1/2	
DIN 24° Heavy											16 x 1 1/2	18 x 1 1/2	20 x 1 1/2
DIN 60°									14 x 1 1/2		16 x 1 1/2	18 x 1 1/2	
Japanese Komatsu® 30° Flare with Metric Threads									14 x 1 1/2			18 x 1 1/2	

All measurements in inches unless otherwise stated.



# Thread Reference Chart

Thread Type	22	24	26	28	30	32	33	36	40	42	45	52
JIC 37° Flare (SAE J514)		1 7/8-12				2 1/2-12						
SAE 45° J512 Flare												
SAE 45° Inverted Flare												
NPTF		1 1/2-11 1/2				2-11 1/2						
NPSM												
NPMAPI		1 1/2-11 1/2				2-11 1/2						
SAE J514 Flareless Tube Fittings												
O-Ring Face Seal (SAE J1453 ORS/ORFS)		2-12										
O-Ring Boss Straight Thread (SAE J514)		1 7/8-12										
BSPP (British Standard Pipe Parallel)		1 1/2-11				2-11						
BSPT (British Standard Pipe Tapered)												
BSP Flat Seat (British Standard Pipe)												
JIS 30° (Parallel Pipe Threads)												
Code 61 Flange (SAE J518) - Dia.		2.37				2.81			3.31			
Code 62 Flange (SAE J518) - Dia.		2.5				3.13						
Caterpillar® Flange - Dia.		2.5										
Komatsu® Flange - Dia.												
Standpipe - OD.	22mm			28mm								
DIN 24° Light	22 x 1 1/2		26 x 1 1/2		30 x 2			36 x 2			45 x 2	
DIN 24° Heavy	22 x 1 1/2	24 x 1 1/2			30 x 2			36 x 2		42 x 2		52 x 2
DIN 60°	22 x 1 1/2		26 x 1 1/2									
Japanese Komatsu® 30° Flare with Metric Thread	22 x 1 1/2	24 x 1 1/2			30 x 1 1/2		33 x 1.5	36 x 1 1/2		42 x 1 1/2		

All measurements in inches unless otherwise stated.

## Fitting Accessories (O-Rings)



Material: NBR  
 Hardness: 90 Shore A  
 Temperature Range: -25°C to 125°C  
 (-13°F to 257°F)

### BSPB (British Standard Pipe Parallel) O-Rings

Descriptive #	Product #	SAP #	ID (in.)	Width (W)	Thread Dash Size
OBSPP-04	60505-0004	20245720	0.256	0.039	-04
OBSPP-06	60505-0006	20245723	0.319	0.063	-06
OBSPP-08	60505-0008	20245539	0.476	0.063	-08
OBSPP-10	60505-0010	20245724	0.516	0.063	-10
OBSPP-12	60505-0012	20245722	0.673	0.063	-12
OBSPP-16	60505-0016	20245536	0.870	0.063	-16
OBSPP-20	60505-0020	20245538	1.146	0.063	-20
OBSPP-24	60505-0024	20245537	1.382	0.063	-24
OBSPP-32	60505-0032	20245721	1.890	0.059	-32

### DIN 24° Light O-Rings

Descriptive #	Product #	SAP #	ID (in.)	Width (W)	Thread Dash Size
ODIN24L-14	60520-0014	20245731	0.236	0.059	-14
ODIN24L-16	60520-0016	20245732	0.295	0.059	-16
ODIN4L-18	60520-0018	20245733	0.354	0.059	-18
ODIN4L-22	60520-0022	20245734	0.472	0.079	-22
ODIN4L-26	60520-0026	20245735	0.591	0.079	-26
ODIN4L-30	60520-0030	20245736	0.787	0.079	-30
ODIN4L-36	60520-0036	20245737	1.024	0.079	-36
ODIN4L-45	60520-0045	20245738	1.260	0.098	-45
ODIN24L-52	60520-0052	20245739	1.496	0.098	-52

### DIN 24° Heavy O-Rings

Descriptive #	Product #	SAP #	ID (in.)	Width (W)	Thread Dash Size
ODIN24H-22	60515-0022	20245740	0.394	0.079	-22
ODIN24H-30	60515-0030	20245741	0.642	0.094	-30
ODIN24H-36	60515-0036	20245742	0.799	0.094	-36
ODIN24H-42	60515-0042	20245743	0.984	0.098	-42
ODIN24H-52	60515-0052	20245744	1.311	0.094	-52

## Fitting Accessories (O-Rings)



Material: NBR  
 Hardness: 90 Shore A  
 Temperature Range: -25°C to 125°C  
 (-13°F to 257°F)

### O-Ring Face Seal (SAE J1453 ORS/ORFS) O-Rings

Descriptive #	Product #	SAP #	ID (in.)	Width (W)	Thread Dash Size
OORFS-04	60525-0004	20245751	0.301	0.07	-04
OORFS-06	60525-0006	20245749	0.364	0.07	-06
OORFS-08	60525-0008	20245750	0.488	0.07	-08
OORFS-10	60525-0010	20245746	0.614	0.07	-10
OORFS-12	60525-0012	20245747	0.739	0.07	-12
OORFS-16	60525-0016	20245748	0.926	0.07	-16
OORFS-20	60525-0020	20245745	1.176	0.07	-20
OORFS-24	60525-0024	20431832	1.489	0.07	-24

### O-Ring Boss Straight Thread (SAE J514) O-Rings

Descriptive #	Product #	SAP #	ID (in.)	Width (W)	Thread Dash Size
ORB-02	60530-0002	20431833	0.239	0.062	-02
ORB-04	60530-0004	20245756	0.351	0.072	-04
ORB-05	60530-0005	20245754	0.414	0.072	-05
ORB-06	60530-0006	20245758	0.468	0.078	-06
ORB-08	60530-0008	20245755	0.644	0.087	-08
ORB-10	60530-0010	20245757	0.755	0.097	-10
ORB-12	60530-0012	20245752	0.924	0.116	-12
ORB-16	60530-0016	20245753	1.171	0.116	-16
ORB-20	60530-0020	20431834	1.475	0.119	-20
ORB-24	60530-0024	20431835	1.720	0.119	-24
ORB-32	60530-0032	20431836	2.337	0.120	-32

### Code 61 & 62 Flange (SAE J518) O-Rings & Caterpillar® Flange O-Rings

Descriptive #	Product #	SAP #	ID (in.)	Width (W)	Thread Dash Size
O6162-08	60500-0008	20245728	0.734	0.139	-08
O6162-10	60500-0010	20431831	0.859	0.139	-10
O6162-12	60500-0012	20245730	0.984	0.139	-12
O6162-16	60500-0016	20245727	1.296	0.139	-16
O6162-20	60500-0020	20245726	1.484	0.139	-20
O6162-24	60500-0024	20245725	1.859	0.139	-24
O6162-32	60500-0032	20245729	2.234	0.139	-32
O6162-40	60500-0040	20246508	2.734	0.139	-40

## Split Flanges, Code 61 and Code 62 (SAE J518)

Flanges are commonly used to connect large sizes of hose and tubing. An O-ring in the flange head seals on a smooth face, female port. The male flange head and female port are held in place with two clamp halves and four bolts. Flanges conform to SAE J518 standard and are identified as Code 61 or the "standard series" and Code 62 or "high pressure series". The two flanges are not interchangeable as Code 61 is used in applications of up to 5,000 psi working pressure. Code 62 is designed for 6,000 psi working pressure. Code 61 and Code 62 are dimensionally different. Specifics on Code 61 and Code 62 flanges are found in the following charts.

### Determine Flange Size

**Method 1:** Measure the port hole inside diameter (ID).

**Method 2:** Measure the "A" dimension on the flange, which is the longest bolt hole spacing from center-to-center.

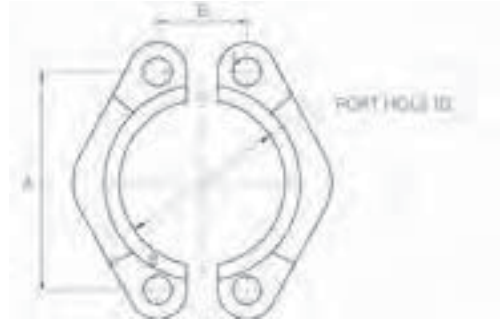

### Assembly Procedure

1. Clean all mating surfaces.
2. Replace O-ring. Lubricate before installation.
3. Partially tighten each bolt in rotation until all are fully tightened to the recommended torque value listed in the Appendix.

## Split Flange Clamp Kits for Code 61 (SAE J518)

Includes Clamp Halves, 4 Bolts, 4 Lockwashers, 1 O-Ring

Descriptive #	Product #	SAP #	Port Hole ID	A	B	Max Working Pressure	Recommended Grade 8 Bolts
			in.	in.	in.	psi	
FL61SC-08	60061-0008	20246512	1/2	1.500	0.685	5000	5/16-18 x 1 1/4
FL61SC-12	60061-0012	20246513	3/4	1.874	0.874	5000	3/8-16 x 1 1/4
FL61SC-16	60061-0016	20246514	1	2.063	1.031	5000	3/8-16 x 1 1/4
FL61SC-20	60061-0020	20246515	1 1/4	2.311	1.189	4000	7/16-14 x 1 1/2
FL61SC-24	60061-0024	20246516	1 1/2	2.752	1.409	3000	1/2-13 x 1 1/2
FL61SC-32	60061-0032	20246517	2	3.063	1.685	3000	1/2-13 x 1 3/4
FL61SC-40	60061-0040	20246467	2 1/2	3.504	2.008	2500	1/2-13 x 1 3/4

## Split Flange Clamp Kits for Code 62 (SAE J518)

Includes Clamp Halves, 4 Bolts, 4 Lockwashers, 1 O-Ring

Descriptive #	Product #	SAP #	Port Hole ID	A	B	Max Working Pressure	Recommended Grade 8 Bolts
			in.	in.	in.	psi	
FL62SC-08	60062-0008	20246519	1/2	1.594	0.717	6000	5/16-18 x 1 1/4
FL62SC-12	60062-0012	20246520	3/4	2.000	0.937	6000	3/8-16 x 1 1/2
FL62SC-16	60062-0016	20246521	1	2.252	1.094	6000	7/16-14 x 1 3/4
FL62SC-20	60062-0020	20246522	1 1/4	2.626	1.252	6000	1/2-13 x 1 3/4
FL62SC-24	60062-0024	20246523	1 1/2	3.126	1.441	6000	5/8-11 x 2 1/4
FL62SC-32	60062-0032	20246524	2	3.811	1.748	6000	3/4-10 x 2 3/4

# German Metric Thread ID Template

Ideal for counter and field identification of German Metric DIN threads

GBS Collateral Item #70086290575800

## Instructions

### Female Threads

1. Use the 12° or 30° angle, as shown in the image to the right, to verify that the seat is 12° or 30° (see note)
2. Use the step gauge to determine Inside Diameter of female port
3. Measure Tube OD with the Tube Inside Diameter Gauge
4. Use Thread ID Table: DIN 2353 along with measured Tube OD to determine if tube is "Heavy" or "Light" Series

### Male Threads

1. Use the 12° or 30° angle, as shown in the image to the right, to verify that the seat is 12° or 30° (see note)
2. Use Fitting Inside Diameter Gauge to measure Inside Threads
3. Refer to Thread ID Table: DIN 3863 along with measured Thread OD to determine Metric Male Thread. Rule of thumb: On Male Thread, measure the ID of the machined surface and subtract 1mm to achieve tube OD. For example, when measuring a heavy-duty series Male on an M14 x 1½ thread, the caliper will measure 7mm (7mm - 1mm = 6mm)

Note: If measured angle is not 12° or 30°, use the Fitting Identification Section in our Hydraulic Hose Catalog Appendix to identify.

Inclusive Angle is the entire angle contained in the machined surface. Each side of the surface measures 1/2 of the total angle (e.g. 24° x .5 = 12°).

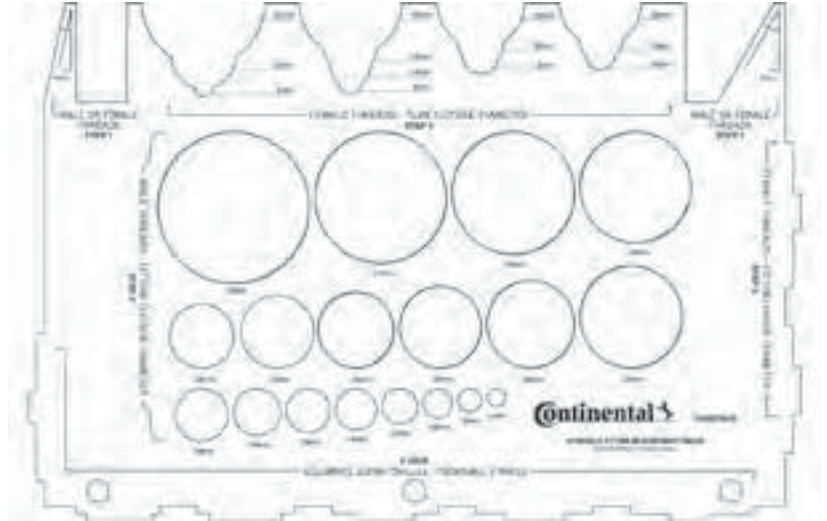

**German Metric Thread Types**

**FEMALE THREADS—STEP 4**

**Thread Identification Table: DIN 2353 24° Cone**

Metric Thread (Dia. x Pitch)	Female Thread ID (mm)	Male Thread OD (mm)	Tube OD Light Series (mm)	Tube OD Heavy Series (mm)
M 12 x 1,5	10,5	12	6	6
M 14 x 1,5	12,5	14	8	8
M 16 x 1,5	14,5	16	10	10
M 18 x 1,5	16,5	18	12	12
M 20 x 1,5	18,5	20	14	14
M 22 x 1,5	20,5	22	15	16
M 24 x 1,5	22,5	24	18	18
M 26 x 1,5	24,5	26	18	18
M 30 x 2,0	28,5	30	22	20
M 36 x 2,0	33,9	36	28	25
M 42 x 2,0	39,9	42	30	30
M 45 x 2,0	42,9	45	35	35
M 52 x 2,0	49,9	52	42	38

**Instructions**

**Female Threads**

1. Use the 12° or 30° angle, as shown in the image to the right, to verify that the seat is 12° or 30° (see note)
2. Use the step gauge to determine Inside Diameter of female port
3. Measure Tube OD with the Tube Outside Diameter Gauge
4. Use Thread ID Table: DIN 2353 along with measured Tube OD to determine if Tube is "Heavy" or "Light" Series

**Male Threads**

1. Use the 12° or 30° angle, as shown in the image to the right, to verify that the seat is 12° or 30° (see note)
2. Use Fitting Inside Diameter Gauge to measure Inside Threads
3. Refer to Thread ID Table: DIN 3863 along with measured Thread OD to determine Metric Male Thread. Rule of Thumb: On Male Thread, measure the ID of the machined surface and subtract 1mm to achieve Tube OD. For example, when measuring a heavy-duty series Male on a M14 x 1½ thread, the caliper will measure 7mm (7mm - 1mm = 6mm).

**Note:** If measured angle is not 12° or 30°, use the Fitting Identification Section in our Hydraulic Hose Catalog Appendix to identify.

**Inclusive Angle** is the entire angle contained in the machined surface. Each side of the surface measures 1/2 of the total angle (e.g. 24° x .5 = 12°).

**MALE THREADS—STEP 3**

**Thread Identification Table: DIN 3863 60° Cone**

Metric Thread (Dia. x Pitch)	Female Thread ID (mm)	Male Thread OD (mm)	Tube OD 60° Cone (mm)
M 12 x 1,5	10,5	12	6
M 14 x 1,5	12,5	14	8
M 16 x 1,5	14,5	16	10
M 18 x 1,5	16,5	18	12
M 22 x 1,5	20,5	22	15
M 26 x 1,5	24,5	26	18
M 30 x 2,0	28,5	30	22
M 38 x 2,0	36,5	38	28
M 45 x 2,0	43,5	45	35
M 52 x 2,0	50,5	52	42

## Code 61/Code 62/CAT® Flange ID Template

Ideal for counter and field identification of SAE Flanges

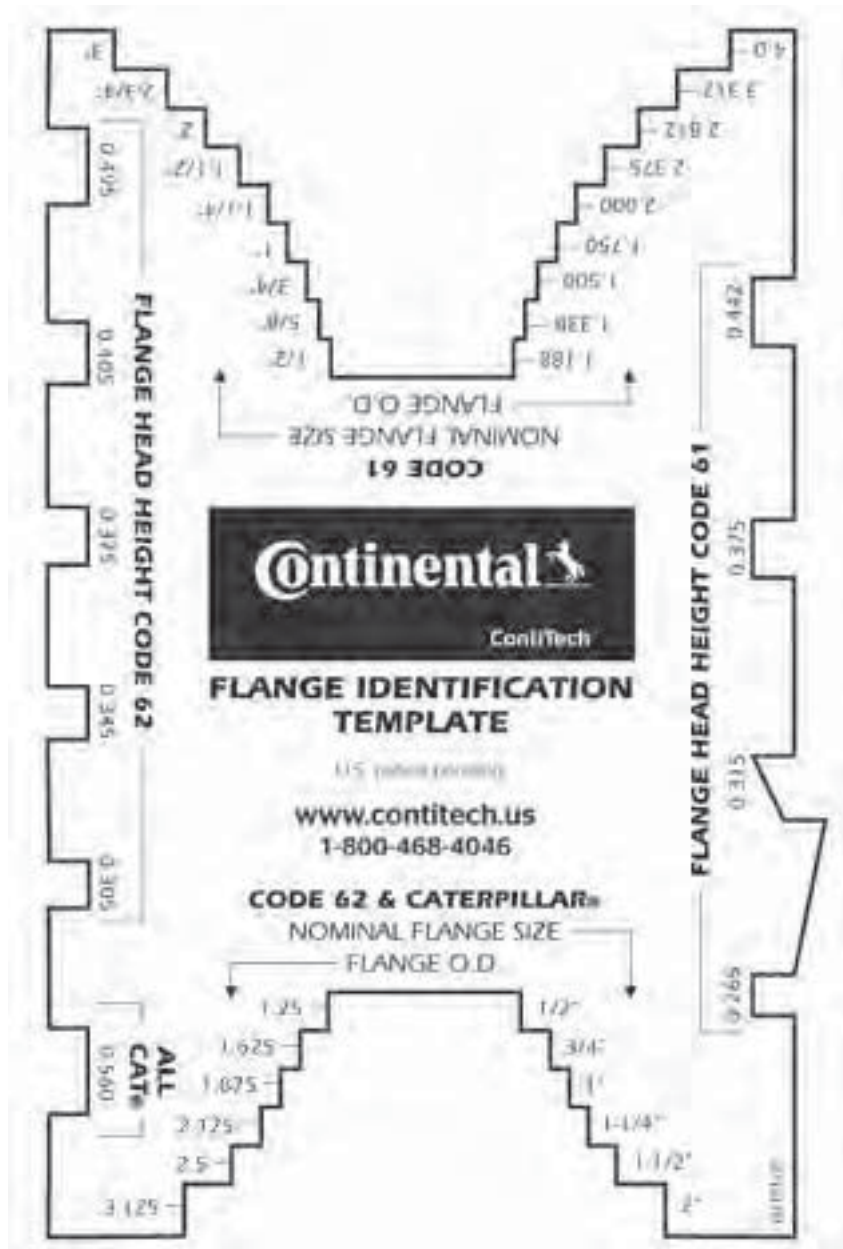

Part Number: GFIT100    SAP # 20243407    Weight: 1.4 oz    Dimensions: 4 7/8" wide x 7" high

Notes:

- Reverse side of template shows dimensional chart for Code 61/Code 62/CAT® flanges.
- Above not to scale.
- As a connection on pumps and motors, the SAE Code 61 and Code 62 4-bolt flanges are used worldwide with three exceptions:
  - Although a common size outside of North America, the #10 size is not an SAE standard size.
  - Although Caterpillar® flanges have the same OD as SAE Code 62, they have a thicker flange head.
  - Porcelain flanges are completely different from SAE flanges.

## Thread Identification Kit

There are many types of North American threads, as well as British, German, French and Japanese threads. With all the thread types and styles available, it is important to properly identify a fitting so that an assembly can be connected correctly within the hydraulic system. This kit and the tools inside will help you identify a broad selection of different thread types.

The Thread Identification Kit includes:

- Fitting Identification Manual
- North American (NA) Thread Pitch Gauge
- International (INT) Thread Pitch Gauge
- Seat Angle Gauges 12°, 30°, 37°, 45°
- ID/OD 3.5" Calipers

Part Number: Fitting IID Pocket Guide

Dimensions: 4½" W x 5½" H



### Steps to Identify a Fitting

1. Select country of origin for the fitting. Use part number if available to determine thread type.
2. Identify the fitting visually using the illustrations in the proper section of the Continental ContiTech Hydraulic Hose and Fittings Catalog or the Hydraulic Fitting Identification Manual included with the identification kit.
3. Measure the inside diameter or the outside diameter of the fitting threads using the ID/OD Calipers.



4. Measure thread pitch using the North American or International Thread Pitch Gauge. The gauge will determine number of threads per inch or the distance between threads of a metric connection.



5. Measure the angle of the fitting's sealing surface using the Seat Angle Gauge.



6. Compare measurements above to the tables in the fitting catalog or identification manual to complete the identification of the fitting.







# Equipment & Accessories

# PC125M

Perma-Crimp™



PC125M

### Description

Carried to the job site with a handle and support stand, the PC125M is ideal for portable crimping requirements. Whether carried on-site or used in a vehicle or even stationary at the shop, the PC125M is designed as a low-volume crimper or for occasional use. Crimp diameter is set and controlled with an easy-to-read micrometer. This affordable crimper is packaged in component parts to fit the need of the user. The PC125M has three power options. No electrical power source is required if using the hand or pneumatic pump option. A 1/2-HP, 110V electric pump is available as well. The PC125M includes die ring pusher, stand, compression ring, pressure plate and a metric micrometer. Pumps and dies are purchased separately.

### Features

- › Easy-to-read, fully adjustable metric micrometer allows precise setting of crimp diameters to an accuracy of +/- .1mm
- › Open design with vertical feed for good operator visibility
- › Removable pusher and spring-loaded die set for easy loading
- › 60-ton cylinder
- › Two-piece, "slide in" die design for easy installation
- › Lightweight for portable field use
- › Color-coded die sets to speed die selection and setup
- › Attach hand, air or electric pump

### Capability

- › 1/4" through 1 1/4" ID, 2-braid hose and 1 1/4" ID 4-spiral hose with all coupling end styles including most bent tubes

### Power Source

- › Optional Two Stage Hand Pump, 10,000 psi (PC125-HPump)
- › Optional Air/Hydraulic Pump, 10,000 psi using 80 psi air (PC125-PPump)
- › Optional 1/2-HP, 110V AC, single phase, 50-60 Hz Electric Pump (PC125M-.5EPump) with foot switch

**Oil Capacity:** 1 gal.

**Mounting:** Stand included

**Dimensions:** 14" L x 11" W x 23 1/2" H

**Weight:** 45 lbs.

### Dies

Part Number	ID	Part Number	ID
PC125-8.5 Black	8.5mm	PC125-27 Brown	27mm
PC125-12 Black	12mm	PC125-31 Silver	31mm
PC125-14 Red	14mm	PC125-34 Purple	34mm
PC125-16 Blue	16mm	PC125-41 Orange	41mm
PC125-19 Green	19mm	PC125-45 Black	45mm
PC125-23 Yellow	23mm	PC125-50 Black	50mm

### Options

- › PC125M-SKit includes the PC125M crimper and 7 die sets including 16mm, 19mm, 23mm, 27mm, 31mm, 34mm and 41mm dies for 1/4" to 1" 1-braid and 2-braid hose.
- › PC125-Shelf-Black Die Storage Shelf Unit 13" deep x 12 1/2" wide x 15" high, 12 lbs
- › PC125-HPump - Two Stage Hand Pump
- › PC125-PPump - Air/Hydraulic Pump
- › PC125M-.5EPump - 1/2 HP, 110V Electric Pump

### Replacement Parts

- › PC125M-Pusher - Die Ring Pusher
- › PC125-Cring - Compression Ring
- › PC125-Pplate - Pressure Plate
- › PC125-Die Screw - Die Screw
- › PC125-Die Spring - Die Spring
- › PC125-HPump - Optional Two Stage Hand Pump
- › PC125-PPump - Optional Air/Hydraulic Pump
- › PC125M-.5EPump - Optional 1/2 HP, 110V Electric Pump
- › PC900-Grease-3 oz. - High-pressure grease in a 3 oz. tube
- › PC900-Grease-1 lb. - High-pressure grease in a 1 lb. can
- › PC900-AerosolLube - High-pressure grease in an aerosol can



**Electric Pump  
(PC125M-.5EPump)**



Metric Micrometer



PC125 Die Set



Hand Pump (PC125 HPump)



PC125 Die Storage Shelf



**Air/Hydraulic  
Pump (PC125-PPump)**

## PC125PS



### Description

The PC125PS is a Positive Stop crimper capable of crimping 2-wire braid hose, and 4-wire spiral hose up through 1" ID. The crimp diameter is controlled through the use of specific die and spacer combinations. The PC125PS is packaged for shop service and includes the crimper and 1-HP, 110V electric pump on a common base; pressure plate; magnetized die pusher; stop/start remote pendant switch; adjustable coupling stop; and adjustable retraction stop.

### Features

- › Matched die and spacer crimp eliminates need to adjust settings
- › Open design with vertical feed for good operator visibility
- › Removable pusher and rubber-cage die sets for easy loading
- › 60-ton cylinder
- › Adjustable retractor stop limits ram retractions for quick repetitive crimps
- › Adjustable coupling stop for accurate, repetitive positioning of the assembly inside the dies.
- › Two-piece, rubber-cage die design for low maintenance
- › Common base for bench mounting
- › Color-coded die sets to speed die selection and set up.
- › 1-HP, 110V pump
- › Pneumatic activation of remote pendant switch

### Capability

- › 1/4" through 1" ID, 2-braid hose and 4-spiral hose

### Power Source

- › 1-HP, 110V AC, single phase, 50-60 Hz electric pump with pneumatic pendant switch

**Oil Capacity:** 1 gal.

**Mounting:** Crimper and pump installed on plate

**Dimensions:** 20" L x 11" W x 10" H

**Weight:** 125 lbs.

### Options

- › PC125PS-SKit includes dies and spacers shown above, and die storage unit

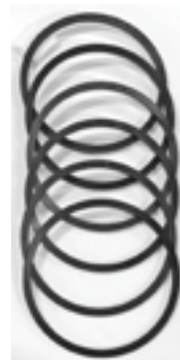

## PC125RCD

Perma-Crimp™



PC125RCD

**Description**

The PC125RCD portable crimper, with its open design, removable pusher and easy-to-use, rubber-cage die set, is designed for higher production volume and repetitive use. Crimp diameter is set and controlled with an easy-to-read micrometer. The PC125RCD is packaged for shop service and includes the crimper and 1-HP, 110V electric pump on a common base, pressure plate, magnetized die ring pusher, stop/start remote pendant switch, metric micrometer, adjustable coupling stop and adjustable retraction stop.

**Features**

- › Easy-to-read, fully adjustable metric micrometer allows precise setting of crimp diameters to an accuracy of +/- .1mm
- › Open design with vertical feed for good operator visibility
- › Removable pusher and rubber-cage die set for easy loading
- › 60-ton cylinder
- › Automatic shut-off for precise crimps
- › Adjustable retraction stop limits ram retractions for quick repetitive crimps
- › Adjustable coupling stop for accurate, repetitive positioning of the assembly inside the dies
- › Two-piece, rubber-cage die design for easy installation and low maintenance
- › Common base for bench mounting
- › Color-coded die sets to speed die selection and setup
- › 1-HP, 110V pump
- › Pneumatic activation (no electric wires) of remote pendant switch

**Capability**

- › 1/4" through 1 1/4" ID, 2-braid hose and 1 1/4" ID 4-spiral hose with all coupling end styles including most bent tubes

**Power Source**

- › 1-HP, 110V AC, single phase, 50-60 Hz, Electric Pump (PC125RCD/150-E1PUMP) with pneumatic stop/start pendant switch

**Oil Capacity:** 1 gal.

**Mounting:** Crimper and pump installed on plate

**Dimensions:** 20" L x 11" W x 19" H

**Weight:** 125 lbs.

**Dies**

Part Number	ID	Part Number	ID
PC125RCD-8.5 BLACK	8.5mm	PC125RCD-34 PURPLE	34mm
PC125RCD-12 BLACK	12mm	PC125RCD-41 ORANGE	41mm
PC125RCD-14 RED	14mm	PC125RCD-45 BLACK	45mm
PC125RCD-16 BLUE	16mm	PC125RCD-50 BLACK	50mm
PC125RCD-19 GREEN	19mm	PC125RCD-AC06	14mm
PC125RCD-23 YELLOW	23mm	PC125RCD-AC08	18.5mm
PC125RCD-27 BROWN	27mm	PC125RCD-AC12	22.4mm
PC125RCD-31 SILVER	31mm		

**Options**

- › PC125RCD SKit includes the PC125RCD crimper and 8 die sets including 16mm, 19mm, 23mm, 27mm, 31mm, 34mm, 41mm, and 50mm dies for 1/4" to 1-1/4" 1-braid, 2-braid, and 4-spiral hose"
- › PC125-Shelf-Black Die Storage Shelf Unit 13" deep x 12 1/2" wide x 15" high, 12 lbs.

**Replacement Parts**

- › PC125-Pusher - Die Ring Pusher With Magnets
- › PC125RCD Press Plate
- › PC125-Cstop - Adjustable Coupling Stop
- › PC125/150-Switch - Pneumatic Start/Stop Pendant Switch for 1 HP Pump
- › PC125/150-E1Pump - 1 HP 110V Electric Pump
- › PC900-Grease-3 oz. - High-pressure grease in a 3 oz. tube
- › PC900-Grease-1 lb. - High-pressure grease in a 1 lb. can
- › PC900-AerosolLube - High-pressure grease in an aerosol can



Metric Micrometer



PC125RCD Die Set



PC125 Magnetic Pusher



PC125 Die Storage Shelf



PC125 Coupling Stop



PC125 Retraction Stop

# PC150 Series

Including PC150-1 & PC150-2 | Perma-Crimp™



PC150-2

### Description

The PC150 is a stationary crimper with more power to manufacture factory-quality hose assemblies quickly and easily. Its open design with removable pusher and “slide in” die configuration allows for good visibility and easy loading of dies and hose assemblies. Crimp diameter is set and controlled with an easy-to-read micrometer. Designed to handle higher volumes in a shop environment, the PC150-2 includes the crimper and 2-HP pump on a common base, pressure plate, compression ring, die ring pusher, stop/start remote pendant switch, metric micrometer, adjustable coupling stop, adjustable retraction stop and work light. The optional PC150-1 includes all the components of the PC150-2 and a 1-HP pump.

### Features

- › Easy-to-read, fully adjustable metric micrometer allows precise setting of crimp diameters to an accuracy of +/- .1mm
- › Open design with vertical feed for good operator visibility
- › Removable pusher and spring-loaded die set for easy loading
- › 80-ton cylinder
- › Automatic shut-off for precise crimps
- › Adjustable retraction stop limits ram retractions for quick repetitive crimps
- › Adjustable coupling stop for accurate, repetitive positioning of the assembly inside the dies
- › Two-piece, “slide in” die set for easy installation
- › Common base for bench mounting
- › Color-coded die sets to speed die selection and setup
- › 2-HP, 220V pump
- › Pneumatic activation (no electric wires) of remote pendant switch

### Capability

- › 1/4” through 1½” ID, 2-braid hose and 4-spiral hose with all coupling styles and most bent tubes

### Power Source

- › 2-HP, 220V AC, single phase, 50-60 Hz Electric Pump (PC150-E2Pump) for PC150-2 crimper
- › Optional 1-HP, 110V AC, single phase, 50-60 Hz Electric Pump (PC125/150-E1Pump) for PC150-1 crimper

**Oil Capacity:** 1 gal.

**Mounting:** Crimper and pump installed on plate

**Dimensions:** 32” L x 16½” W x 29” H

**Weight:** 275 lbs.

### Dies

Part Number	ID	Part Number	ID
PC150-8.5 Black	8.5mm	PC150-27 Brown	27mm
PC150-12 Black	12mm	PC150-31 Silver	31mm
PC150-14 Red	14mm	PC150-34 Purple	34mm
PC150-16 Blue	16mm	PC150-41 Orange	41mm
PC150-19 Green	19mm	PC150-45 Black	45mm
PC150-23 Yellow	23mm	PC150-50 Black	50mm
PC150-27 Brown	27mm	PC150-56 Black	56mm

### Options

- › PC150-1 SKit includes PC150-1 crimper and 7 die sets including 16mm, 19mm, 23mm, 31mm, 41mm, 50mm, 56mm dies for 1/4” to 1½” 1-braid to 4-spiral hose
- › PC150-2 SKit includes PC150-2 crimper and 7 die sets including 16mm, 19mm, 23mm, 31mm, 41mm, 50mm, 56mm dies for 1/4” to 1½” 1-braid to 4-spiral hose
- › PC150-Shelf-Black Die Storage Shelf Unit 15” deep x 20½” wide x 16” high, 25 lbs.
- › PC150-Spacer-Spacer Kit for Elbows
- › PC150-1 with 1 HP Pump
- › PC150-2 with 2 HP Pump

### Replacement Parts

- › PC150-Pusher - Die Ring Pusher
- › PC150-Cring - Compression Ring
- › PC150-Pplate - Pressure Plate
- › PC150-Cstop - Adjustable Coupling Stop
- › PC150-Die Screw - Die Screw
- › PC150-Die Spring - Die Spring
- › PC125/150-Switch - Pneumatic Start/Stop Pendant Switch for 1-HP or 2-HP Pump
- › PC150-E2Pump - 2-HP Electric Pump for PC150-2 Crimper
- › PC125/150-E1Pump - 1-HP Electric Pump for PC150-1 Crimper
- › PC900-Grease-3oz - High-pressure grease in a 3 oz. tube
- › PC900-Grease-1lb - High-pressure grease in a 1 lb. can
- › PC900-AerosolLube - High-pressure grease in an aerosol can



PC150 Die Storage Shelf



Metric Micrometer



PC150 Die Set



PC150 Coupling Stop



PC150 Retraction Stop

## PC150H Series

Including PC150H-1 & PC150H-2 | Perma-Crimp™



PC150H

### Description

The PC150H offers the ease of use of a horizontal crimper with the power and precise adjustment capabilities usually found in more costly models. With the same crimping capability as the PC150 Series, the "H" model offers hose feed horizontally from either front or rear through a large 4.9 in. throat opening. The PC150H can be ordered with a 1-HP electric pump (PC150H-1) or a 2-HP electric pump (PC150H-2), producing maximum force in a small package. The PC150H makes repetitive crimps fast and easy to accomplish with a precise, direct-read digital adjustment and a built-in cylinder retraction stop. The PC150H also offers convenience features found in both our vertical and horizontal crimpers including a pneumatic start/stop pendant switch, a magnetic die change tool, an optional die rack for storing dies and master die grease fittings as a special feature for easy lubrication.

### Features

- › Easy-to-read micrometer provides precise crimp settings
- › Hose feed is horizontal from both front and rear
- › Easy die loading with magnetic die change tool
- › Max die size 56mm
- › 155-ton crimping force
- › Automatic shut-off for precise crimps
- › Retraction stop limits die travel for faster repetitive crimps
- › Large 13-quart oil reservoir to cool components during repetitive crimps
- › Pneumatic activation using remote pendant switch
- › 1-HP and 2-HP power options

### Capability

- › 1/4" through 1½" ID, 2-braid hose and 4-spiral hose with all coupling styles and most bent tubes

### Power Source

- › 1-HP, 110V AC, single phase (PC150H-1)
- › 2-HP, 220V AC, single phase (PC150H-2)

**Oil Capacity:** 13 qt.

**Mounting:** Bench or cabinet

**Dimensions:** 15" L x 23½" W x 20½" H

**Weight:** 245 lbs.

### Dies

Part Number	ID	Part Number	ID
PC150H-8.5	8.5mm	PC150H-31	31mm
PC150H-12	12mm	PC150H-34	34mm
PC150H-14	14mm	PC150H-41	41mm
PC150H-16	16mm	PC150H-45	45mm
PC150H-19	19mm	PC150H-50	50mm
PC150H-23	23mm	PC150H-56	56mm
PC150H-27	27mm		

### Options

- › PC150H-1 SKit includes the PC150H-1 crimper and 7 die sets including 16mm, 19mm, 23mm, 31mm, 41mm, 50mm and 56mm
- › PC150H-2 SKit includes the PC150H-2 crimper and 7 die sets including 16mm, 19mm, 23mm, 31mm, 41mm, 50mm and 56mm
- › PC150H-Rack - Black die cabinet. 7" deep x 13" wide x 18" high, holds 9 dies

### Replacement Parts

- › PC900-Grease-1lb. - High-pressure grease in 1 lb. can
- › PC900-AerosolLube - High-pressure grease in an aerosol can
- › PC125/150 Switch - Pneumatic Start/Stop Pendant Switch for 1HP or 2 HP Pump
- › PC150H-DCT - Die Change Tool



PC150H Die Set



Die Change Tool



PC150H Die Rack



Digital Gauge

# PC200 Series

Including PC200-1 & PC200-2 & PC200-3 | Perma-Crimp™



PC200-1

### Description

The PC200 is a high-volume, high-capacity stationary crimping machine utilizing microprocessor control for the fastest, most accurate crimping system available. Crimp settings, dwell time, pre-set start positions and auto/manual operation are all easily set with electronic controls. This production crimping machine is a quick and easy way to make factory-quality hose assemblies. The standard package is the PC200-1 crimping machine which includes a 7.5-HP, 230V/3 phase pump and foot pedal. The optional PC200-2 crimping machine includes a 7.5-HP, 480V/3 phase pump and foot pedal. The optional PC200-3 (single phase) crimping machine includes a 5-HP, 220V/single phase pump and foot pedal.

### Features

- › Hose feed is horizontal from both front or rear
- › Accurate electronic PLC crimp diameter adjustment
- › Manual or automatic mode
- › Max die size +78mm
- › 340-ton cylinder
- › Automatic shut-off for precise crimps
- › Power return stroke and return limit control
- › Rapid retraction of die fingers through hydraulic system
- › Die sets easily changed using hand tool
- › Accommodates bent tube/elbow couplings with the ability of installing 2", 90 degree fittings on both ends

### Capability

- › 1/4" through 2" ID, 2-braid hose and 2" 6 spiral hose with all coupling end styles including most bent tubes

### Power Source

- › 7.5-HP, 230V AC, 3 phase, 60 Hz (PC200-E7.5-1 Pump)
- › Optional 7.5-HP, 480V AC, 3 phase, 60 Hz (PC200-E7.5-2 Pump) for the PC200-2 crimping machine
- › Optional 5-HP, 220V AC, single phase, 60 Hz for the PC200-3 crimping machine

**Oil Capacity:** 8 gal.

**Mounting:** Bench or cabinet

**Dimensions:** 18½" L x 27½" W x 31½" H (without die cabinet)

**Weight:** 573 lbs. (excluding cabinet)

### Dies

Part Number	ID	Part Number	ID
PC200-8.5	8.5mm	PC200-41	41mm
PC200-12	12mm	PC200-45	45mm
PC200-14	14mm	PC200-50	50mm
PC200-16	16mm	PC200-56	56mm
PC200-19	19mm	PC200-62	62mm
PC200-23	23mm	PC200-69	69mm
PC200-27	27mm	PC200-74	74mm
PC200-31	31mm	PC200-78	78mm
PC200-34	34mm		

### Options

- › PC200-1 SKit includes the PC200-1 crimping machine and 10 die sets including 16mm, 19mm, 23mm, 27mm, 31mm, 34mm, 41mm, 50mm, 56mm, 62mm, 69mm, 78mm dies for 1/4" to 2" 1-braid to 6-spiral hose
- › PC200-2 SKit includes the PC200-2 crimping machine and 10 die sets including 16mm, 19mm, 23mm, 27mm, 31mm, 34mm, 41mm, 50mm, 56mm, 62mm, 69mm, 78mm dies for 1/4" to 2" 1-braid to 6-spiral hose
- › PC200-3 SKit includes the PC200-3 crimping machine and 10 die sets including 16mm, 19mm, 23mm, 27mm, 31mm, 34mm, 41mm, 50mm, 56mm, 62mm, 69mm, 78mm
- › PC200-Rack - Black Die Cabinet 20" deep x 30" wide x 29" high
- › PC200-MBS - Manual Back Stop
- › PC200-EBS - Electric Back Stop

### Replacement Parts

- › PC900-Grease-1lb. - High-pressure grease in a 1 lb. can
- › PC900-AerosolLube - High-pressure grease in an aerosol can



PC200 Die Set



Control Panel



Foot Switch



Optional Automatic Back Stop



Die Cabinet

## PC400 Series

Including PC400 & PC400-1 | Perma-Crimp™



PC400

### Description

The PC400 is a high-volume, high-capacity stationary crimper utilizing microprocessor control for the fastest, most accurate crimping system available. Crimp settings, dwell time, pre-set start positions and auto/manual operation are all easily set with electronic controls. This production crimper is a quick and easy way to make both hydraulic and industrial hose assemblies. The standard package is the PC400 crimper which includes a 7.5-HP, 230V/3 phase pump and foot pedal. The optional PC400-1 crimper includes a 5-HP, 230V/single phase pump and foot pedal.

### Features

- › Hose feed is horizontal from either front or rear
- › Accurate electronic PLC crimp diameter adjustment
- › Manual or automatic mode
- › Maximum die opening: die closed diameter + 78mm (hydraulic) and 122mm (industrial)
- › 265-ton cylinder
- › Automatic shut-off for precise crimps
- › Power return stroke and return limit control
- › Rapid retraction of die fingers through hydraulic system
- › Die sets easily changed using hand tool
- › Accommodates bent tube/elbow couplings with the ability of installing 2", 90 degree fittings on both ends

### Capability

- › 1/4" through 2" ID, 2-braid hose, and 2" 6-spiral hose, and 4" industrial hose with all coupling end styles including most bent tubes
- › 1/2" through 4" ID industrial hose

### Power Source

- › 7.5-HP, 230V AC, 3 phase, 60 Hz for the PC400 crimper
- › Optional 5-HP, 230V AC, single phase for the PC400-1 crimper

**Oil Capacity:** 8 gal.

**Mounting:** Bench or cabinet

**Dimensions:** 18½" L x 27½" W x 31½" H (without die cabinet)

**Weight:** 573 lbs. (excluding cabinet)

### Hydraulic Dies (PC400 utilizes PC200 dies)

Part Number	ID	Part Number	ID
PC200-8.5	8.5mm	PC200-34	34mm
PC200-12	12mm	PC200-41	41mm
PC200-14	14mm	PC200-45	45mm
PC200-16	16mm	PC200-50	50mm
PC200-19	19mm	PC200-56	56mm
PC200-23	23mm	PC200-62	62mm
PC200-27	27mm	PC200-69	69mm
PC200-31	31mm	PC200-74	74mm
		PC200-78	78mm

### Industrial Dies

Part Number	ID	Part Number	ID
PC400-86-125L	86mm	PC400-114-125L	114mm
PC400-90-125L	90mm	PC400-118-125L	118mm

### Options

- › PC400-SKit includes the PC400 crimper and 12 die sets including 16mm, 19mm, 23mm, 27mm, 31mm, 34mm, 41mm, 50mm, 56mm, 62mm, 69mm, 78mm dies for 1/4" to 2" 1-braid to 6-spiral hose
- › PC400-1 SKit includes the PC400-1 crimper and 12 die sets including 16mm, 19mm, 23mm, 27mm, 31mm, 34mm, 41mm, 50mm, 56mm, 62mm, 69mm, 78mm dies for 1/4" to 2" 1-braid to 6-spiral hose
- › PC200-Rack - Black Die Cabinet 20" deep x 30" wide x 29" high
- › PC200-MBS - Manual Back Stop
- › PC200-EBS - Electric Back Stop

### Replacement Parts

- › PC900-Grease-1lb - High-pressure grease in a 1 lb. can
- › PC900-AerosolLube - High-pressure grease in an aerosol can



Foot Switch



Control Panel



Die Cabinet



Optional Automatic Back Stop



# PC440 Series

Including PC440 & PC440-1 | Perma-Crimp™



**PC440**

### Description

The patented ACT™ Crimp Controller

- › Can store up to 50 dies and 150 crimp settings
- › Pressure Transducer monitors crimping “effort” eliminating “trial and error” crimping
- › Can track number of crimps and automatically pause for a quality check at a preset interval
- › Automatically converts inch to mm and mm to inch so that no calculation is ever required

### Features

- › 315 Tons crimping force
- › Maximum head opening w/o dies 9.75 in (248 mm)
- › Hose capacity from 1/4 inch up to 4 inches industrial hose
- › Fixed 6 o'clock die position holds your assembly in place achieving accuracy during the crimping process
- › Bearing material master die wear plates for longer durability
- › 7.5 HP (1 stage pump)
- › Fully adjustable crimp diameter
- › Manual or automatic ACT™ controls
- › Enter crimp diameter in either inch or metric
- › Store frequently used dies and crimp settings in memory
- › Complete range of dies and accessories available

### Capability

- › 1/4” through 2” ID, 2-braid hose, and 2” 6-spiral hose, and 4” industrial hose with all coupling end styles including most bent tubes
- › 1/2” through 4” ID industrial hose

### Power Source

- › 220 Volt 3 Phase
- › Optional 440 Volt 3 Phase and 220 Volt Single Phase

### Dies

Part Number	ID	Part Number	ID
PC440-12	12mm	PC440-45	45mm
PC440-14	14mm	PC440-50	50mm
PC440-16	16mm	PC440-56	56mm
PC440-19	19mm	PC440-62	62mm
PC440-23	23mm	PC440-69	69mm
PC440-27	27mm	PC440-74	74mm
PC440-31	31mm	PC440-78	78mm
PC440-34	34mm	PC440-85	85mm
PC440-41	41mm		

PC440 Dies included (16mm, 19mm, 23mm, 27mm, 31mm, 34mm, 41mm, 45mm, 50mm, 56mm, 62mm, 69mm, 74mm, 78mm)



**Foot Switch**



**Control Panel**



**Large Opening**

# PC600L Crimper

Perma-Crimp™

## Description

The PC600L is a high-volume, high-capacity stationary crimper utilizing the fully automatic ACT3™ microprocessor controller. The PC600L can produce 2,200 crimps per hour with 350 tons of crimping force to allow for both hydraulic and industrial hose assemblies, and it is ideal for production assembly applications. The standard PC600L crimper includes a 7.5-HP, 230 V AC, 3-phase hydraulic pump.

## Features

- › Fully automatic ACT3 controller
- › Manual & automatic operation
- › Utilizes the PC200/400 dies with easy-to-change die tool
- › 350-ton cylinder
- › Built-in heavy-duty base with die holders
- › Allows for 2,200 crimps per hour
- › Automatic shut-off for precise crimps
- › Power return stroke and return limit control

## Capability

- › 1/4" through 2½" ID, 2-braid and 6-spiral hydraulic hose
- › 3/16" through 6" ID industrial hose

## Power Source

- › 7.5-HP, 230V AC, 3 phase, 60 Hz

## Dimensions

- › Master die inside diameter - 145mm
- › Master die opening w/o dies - 273mm
- › Maximum swaging diameter - 192mm
- › Maximum die opening - Die+128mm
- › Pump size: 21" L x 34" W x 36½" H
- › Pump weight: 450 lbs (205 kg)
- › Machine size: 22" L x 36" W x 57" H

**Weight:** 4,500 lbs. (2,041kg) die base/cabinet (shipping weight)

The following dies are included in the standard PC600-P SKit

### Hydraulic Dies:

SAP#	Descriptive #	Description
20244976	PC200-16	16MM DIE
20244977	PC200-19	19MM DIE
20244978	PC200-23	23MM DIE
20244980	PC200-31	31MM DIE
20244982	PC200-41	41MM DIE
20244984	PC200-50	50MM DIE
20244985	PC200-56	56MM DIE
20244986	PC200-62	62MM DIE
20244987	PC200-69	69MM DIE
20249890	PC200-78	78MM DIE



Optional Automatic Back Stop

### Continental ContiTech Part Numbers:

SAP#	Descriptive #	Description
20673598	PC600-P SKit	PC600-P SKit 16-23, 31, 41, 50, 56, 62, 69, 78
20673588	PC600-P SKit H&I	Includes Hydraulic & Industrial Dies (Hyd: 16-23, 31, 41, 50, 56, 62, 69, 79) (Ind: 84, 92, 100, 125, 166, 178)
20267266	PC200/400-DCT	Die Change Tool
20244972	PC200-EBS	Electric Back Stop (Optional)
20244971	PC200-MBS	Manual Back Stop

# PC1000 Crimper

Perma-Crimp™

## Description

The PC1000 is a high-volume, high-capacity stationary crimper utilizing the fully automatic ACT3™ microprocessor controller. The PC1000 can produce 1,415 crimps per hour with 450 tons of crimping force to allow for both Hydraulic and Industrial hose assemblies, ideal for production assembly applications. The standard PC1000 crimper includes a 7.5-HP, 230 V AC, 3-phase hydraulic pump.

## Features

- › Fully automatic ACT3™ controller
- › Manual & automatic operation
- › Utilizes the PC200/400 dies with easy-to-change die tool
- › 350-ton cylinder
- › Built-in, heavy-duty base with die holders
- › Allows for 1,415 crimps per hour
- › Automatic shut-off for precise crimps
- › Power return stroke and return limit control

## Capability

- › Up through 2½" ID, 2-braid, 4-spiral and 6-spiral hydraulic hose
- › 3/16" through 10" ID industrial hose

## Power Source

- › Standard: 7.5-HP, 230 V AC, 3 Phase, 60 Hz
- › Optional: 7.5-HP, 460 V AC, 3 Phase, 60 Hz

## Dimensions

- › Master Die Inside Diameter: 230mm
- › Master Die Opening w/o Dies: 350mm
- › Maximum Swaging Diameter: 192mm
- › Maximum Die Opening: Die +125mm
- › Machine Size: 30" L x 44" W x 74" H

**Weight:** 6,185 lbs. (2,806kg)

The following dies are included in the standard PC1000-PX SKit

### Hydraulic Dies:

SAP#	Descriptive #	Description
20244975	PC200-14	14 MM DIE
20244976	PC200-16	16 MM DIE
20244977	PC200-19	19 MM DIE
20244978	PC200-23	23 MM DIE
20244980	PC200-31	31 MM DIE
20244982	PC200-41	41 MM DIE
20244984	PC200-50	50 MM DIE
20244985	PC200-56	56 MM DIE
20244986	PC200-62	62 MM DIE
20244987	PC200-69	69 MM DIE
20249890	PC200-78	78 MM DIE
20562098	PC600-84	84 MM DIE
20562099	PC600-92	92 MM DIE
20562650	PC600-100	100 MM DIE
20562651	PC600-108	108 MM DIE
20562652	PC600-116	116 MM DIE
20562653	PC600-126	126 MM DIE
20590712	PC1000-166	166 MM DIE
20590713	PC1000-178	178 MM DIE
20590714	PC1000-215	215 MM DIE
20590715	PC1000-245	245 MM DIE



### Continental ContiTech Part Numbers:

SAP#	Descriptive #	Description
20588181	PC1000-PX SKit	PC1000-PX SKit

(3 Phase 230V dies 14-245) PC1000 Utilizes PC200/400/600 Dies & Change Tool

## PCTB-1500 & PCTB-2500

### Test Benches

#### Description

Continental ContiTech PCTB Series Test Benches provide a safe and efficient method to test hose assemblies for burst or proof testing.

#### Features

- › Optional electronic model with programmable control including paper printout
- › 1/2" polycarbonate safety window
- › Safety lock to prevent operation when door is not closed
- › Standard garden hose inlet for water supply
- › Factory air inlet supply, 85 psi minimum required
- › Powder-coated finish for durability
- › Polyurethane bed liner material coating on interior
- › 7-port outlet manifold for multiple testing
- › Built-in work light for good visibility during testing

#### Capability

- › PCTB-1500 – Test pressure range to 21,500 psi (1500 bar)
- › PCTB-2500 – Test pressure range to 37,500 psi (2500 bar)

#### Power Source

Standard 110 V AC, Single Phase Grounded Outlet

#### Dimensions

- › Interior: 18" H x 35" W x 71" L
- › Includes test bench legs – test area at a convenient working height
- › Full opening allows for hose assemblies to be loaded on a skid

**Weight:** 750 lbs.



#### Continental ContiTech Part Numbers:

SAP#	Descriptive #
20439763	PCTB-1500 TEST BENCH
20439764	PCTB-1500 PLC TEST BENCH
20554088	PCTB-2500 TEST BENCH
20554089	PCTB-2500 PLC TEST BENCH



## HS150

### Hose Saws



#### Description

Designed to cut 1 & 2 braid hydraulic hose up to 1-1/2" ID and up to 1 1/4" 4 Spiral Hose.

#### Features

- › 1-HP
- › Single Phase
- › 60 Hz
- › 115 V AC
- › 3450 RPM w/10" serrated blade
- › 85 lbs.

**SAP # 20614553**

## HS301



### Description

Designed to cut 1 & 2 braid hydraulic hose up to 2" ID and up to 1¼" 4 or 6 Spiral Hose.

### Features

- › 3-HP
- › Single Phase
- › 60 Hz
- › 230 V AC
- › 3450 RPM w/12" serrated blade
- › 150 lbs.

**SAP # 20614555**

## HS303

### Description

Designed to cut 1 & 2 braid hydraulic hose up to 2" ID and up to 1¼" 4 or 6 Spiral Hose.

### Features

- › 3-HP
- › Three Phase
- › 60 Hz
- › 230 V AC
- › 3450 RPM w/12" serrated blade
- › 150 lbs.

**SAP # 20614554**

## HS501



### Description

Designed to cut 1 & 2 braid hydraulic hose up to 2" ID and up to 2" 4 or 6 Spiral Hose.

### Features

- › 5-HP
- › Single Phase
- › 60 Hz
- › 230 V AC
- › 3450 RPM w/12" serrated blade
- › 156 lbs.

**SAP # 20614557**

## HS503

### Description

Designed to cut 1 & 2 braid hydraulic hose up to 2" ID and up to 2" 4 or 6 Spiral Hose.

### Features

- › 5-HP
- › Three Phase
- › 60 Hz
- › 230 V AC
- › 3450 RPM w/12" serrated blade
- › 156 lbs.

**SAP # 20614556**

# CB102 & CB103

## Fitting Cabinets

### Features

- › Stackable 12" deep cabinets
- › Durable powder-coated textured charcoal gray finish
- › Optional base stand provides 8 inches more of height for comfortable access to lower shelves

### Highlights

- › Stackable - up to 3 units high
- › Durable - High impact Polystyrene, Blue Bins
- › No assembly - Cabinets ship assembled (except optional stand)
- › Capacity - weight capacity is 120 lbs., combined stacked capacity weight not to exceed 200 lbs.
- › Overall cabinet dimensions: 35"W x 11"D x 22"H (excludes base stand)

CB103 as shipped, dividers included.



Hydraulic Dies:					Shelf Dimensions (in)			Bin Dimensions (in.)			
SAP#	Descriptive #	Industrial Standard/Active	Color	Description	Weight (lb)	D	L	H	D	W	H
20754797	CB102	93103	Grey	Stackable Cabinet w/o Bins	64	11	34	4 11/16			
20754796	CB103	93102	Grey	Stackable Cabinet w/5.5" Bins & Dividers	40	11	34	4 11/16	11 5/8	11 5/8	4 5/8
20754798	CB303	93303	Grey	Base Stand for 11" Stackable Cabinet	16	11 1/4	35 1/4	8			
20754799	CB203	93203	Blue	CB203 - Blue 3" Bins 6 pack	5				11 5/8	3 3/4	4 5/8
20754883	C8203-DIV	93203-DIV	Black	CB203 - Div 3" Dividers 6 pack	1						
20754880	CB204	93204	Blue	CB204 - Blue 5.5" Bin 6 pack	6				11 5/8	5 9/16	4 5/8
20754884	CB204-DIV	93204-DIV	Black	CB204 - Div 5.5" Dividers 6 pack	1						
20754881	CB205	93205	Blue	CB205 - Blue 8" Bin 4 pack	6				11 5/8	8 3/8	4 5/8
20754885	CB205-DIV	93205-DIV	Black	CB205 - Div 8" Dividers 6 pack	1.5						
20754882	C8206	93206	Blue	CB206 - Blue 11" Bins 4 pack	8				11 5/8	11 1/8	4 5/8
20754886	CB206-DIV	93206-DIV	Black	CB206 - Div 11" Dividers 8 pack	2						
20759232	CB213	93211	Yellow	CB213 Yellow 3" Bins 6 Pack	5				11 5/8	3 3/4	4 5/8
20759233	CB214	93212	Yellow	CB214 Yellow 5.5" Bins 6 Pack	6				11 5/8	5 9/16	4 5/8
20759234	CB215	93213	Yellow	CB215 Yellow 8" Bins 4 Pack	6				11 5/8	8 3/8	4 5/8
20759235	CB216	93214	Yellow	CB216 Yellow 11" Bins 4 Pack	8				11 5/8	11 1/8	4 5/8
<b>Replacement for C8200 and C8201</b>											
20766037	CB200A	93200A	Yellow	CB200A - Replacment for CB200 8" bin	8				11 5/8	8	4 1/8
20766038	CB201A	93201A	Yellow	CB201A - Replacment for CB201 4" bin	9				11 5/8	4	4 1/8
20766039	CB201A-DIV	93201A-DIV	Black	CB201 A-DIV divider for DB201 A	1						
20766090	CB200A-DIV	93200A-DIV	Black	CB200A-DIV divider for DB200A	1						

## Selecting the Proper Hose Assembly

In order to obtain the best service from any particular hose application, two important conditions must be fulfilled.

- 1) Select the right hose for the job.
- 2) Make sure that it is fitted correctly and used in the proper manner.

Carefully consider the application requirements. A helpful guide is the S.T.A.M.P.E.D. process. S.T.A.M.P.E.D. is an acronym and stands for the seven major information areas required to provide a quality hose assembly

- S SIZE** – ID, OD, and length of the assembly
- T TEMPERATURE** – includes temperature of fluid conveyed and the climatic conditions
- A APPLICATION** – the conditions of use, including abrasion, flexing and routing
- M MATERIAL** – type of material conveyed, including composition and concentration
- P PRESSURE** – hose assembly working pressure and surge or back pressure
- E ENDS** – definition of the fitting, including thread type, gender, bent tube, swivel and orientation
- D DELIVERY** – time allowed for delivery, including testing, quality assurance and packaging

To assist in obtaining and conveying information regarding the application, a copy of the S.T.A.M.P.E.D. application form is included in this catalog. This inquiry sheet can be sent to any Continental ContiTech authorized distributor for a hose recommendation.

**Please Note:**

A hose should always be selected based on its **rated working pressure**. Do not use **minimum burst pressure** as a guideline in selecting the hose. Minimum burst pressure decreases over the use and life of the hose. A hose should be selected based on its rated working pressure to provide a normal service life. In addition, always select a hose by giving consideration to its recommended temperature limits. Hose service life is reduced if the temperatures of the fluids being conveyed or ambient temperatures exceed the recommended limits.

# S.T.A.M.P.E.D. Form

<b>Size</b>	
ID	
OD	
Hose Length (OAL or uncpld. lgth.)	
Tolerances	
<b>Temperature</b>	
of Material Being Conveyed	
(high, low, ambient)	
of Outside Exposure (high, low, ambient)	
Intermittent?	
Constant?	
Sub-Zero Exposure	
<b>Application(s)</b>	
Indoor and/or Outdoor Use	
Intermittent or Continuous Use	
Flexibility Required (min. bend radius)	
Movement (static, vibrations, flexing)	
<b>External Conditions:</b>	
Abrasion	
Oil	
Solvents	
Acid	
Ozone	
Electrical/Static Conductive	
<b>Oil Resistance:</b>	
Tube	
Cover	
Flame Resistance	
Noncontaminating Materials	
Hose Currently in Use	
Current Hose Service Life/Failure Description	
Service Life Desired	
<b>Material(s) Being Conveyed</b>	
Solids (size, description)	
Gaseous (volatility, inert)	
Liquids (flammability, causticity, acid, alkaline, solution/concentration)	
Chemical Names (generic)	

<b>Pressures(s)</b>	
Working Pressure (including surges)	
Burst Pressure	
Suction or Vacuum Requirements	
Velocity	
Impulse	
<b>Ends &amp; Fittings</b>	
Type of Threads	
Male/Female	
Reusable/Nonreusable	
Material for Fittings	
Swivel or Non-Swivel	
Straight or Bent Tube	
Fitting 1 & 2 Orientation	
Other	
Cut to Length	
Crimp Specs or Crimper Used	
<b>Delivery</b>	
Lead Time	
Quantity	
Stock/Nonstock	
Special Print	
Special Packaging	
<b>Other Information</b>	
Customer:	Date:
Customer No:	
Ship To:	
Bill To:	
Telephone:	Fax:

Bolded block areas MUST be filled out on all inquiries.



# Defining Hose and Assembly Length

## Identifying Hose ID

In the case of a hose assembly replacement, the inside diameter (ID) of the hose can be obtained from the existing assembly. The ID may be printed on the layline of the hose or may have to be measured. Before cutting the assembly, measure the overall assembly length and record the orientation of the fittings. See the following sections on how to measure overall assembly length and the offset angle between the two fittings. If the ID of the hose has not been determined, utilize the Hose ID Selection Nomograph in the Appendix. The chart will yield a hose ID recommendation based on flow capacity and flow velocity.

Hydraulic hose size or inside diameter is sometimes referred to as the "Dash Size." The Dash number is the ID of the hose in sixteenths of an inch. For example, a 1/4" ID hose, is equivalent to 4/16". The "Dash Size" would be "-4." A listing of the Dash sizes is shown below. Note that the Dash number applies to the hose ID for all hoses except SAE 100R5. In the case of SAE 100R5, the Dash number is equal to a relevant tube outside diameter (OD).

Dash #	Hose ID (Except SAE 100R5)		SAE Dash Size* (SAE 100R5)	
	in.	mm	in.	mm
-2	1/8	3.2		
-3	3/16	4.8		
-4	1/4	6.4	3/16	4.8
-5	5/16	7.9	1/4	6.4
-6	3/8	9.5	5/16	7.9
-8	1/2	12.7	13/32	10.3
-10	5/8	15.9	1/2	12.7
-12	3/4	19.0	5/8	15.9
-14	7/8	22.2		
-16	1	25.4	7/8	22.2
-20	1¼	31.8	1½	28.6
-24	1½	38.1	1¾	35.0
-32	2	50.8	1¾	46.0
-36	2¼	57.6		
-40	2½	63.5	2¾	60.3
-48	3	76.2		
-56	3½	88.9		
-64	4	101.6		
-72	4½	115.2		

\*SAE Dash Size equals OD of the tubing, which has approximately the same ID as the hose, expressed in 1/16".

## Identifying Overall Assembly Length

Unless otherwise specified by the customer, the assembly's overall length is measured from the extreme end of one fitting to the extreme end of the other except for the O-ring face seal fittings, which shall be measured from the sealing face. Where elbow fittings are used, measurement shall be to the centerline of the sealing surface of the elbow end.

## Assembly Length Measurements

### Overall Assembly Length

Female Swivel Ends (except O-ring Face Seal)  
Measure to sealing surface.

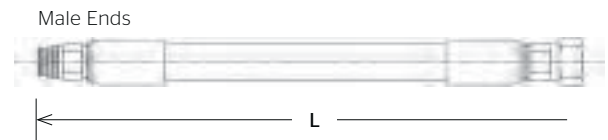

### Bent Stem Swivel Female Ends



### Flange Ends



### Swivel O-Ring Face Seal Ends

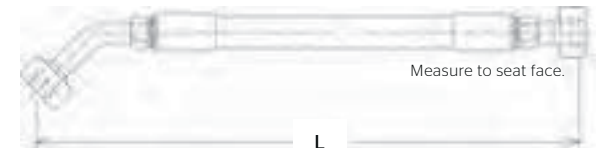

# Defining Hose and Assembly Length

## Determining Hose Cut Length

The hose cut length for a hose assembly is calculated by subtracting the cut-off factor (distance from the bottom of the ferrule or collar to the end of the fitting or an internal sealing surface), denoted as "C" cut-off in the tables, from the actual assembly length required.

The "C" cut-off factor can be obtained from the fitting product tables. An example is shown below:

Part #	Hose ID (in.) (mm)	Hose Dash Size	Thread Size (in.-TPI)	Thread Dash Size	"C" Cut-Off Factor (mm)	Stem Hex (mm)	
JIC Solid Male 37	3/8	9.5	-6	9/16-18	-6	26.3	17

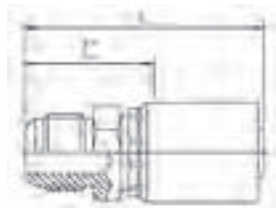

Knowing the overall length of the assembly desired, you subtract the "C" cut-off factor for each fitting from the overall length to obtain the hose cut length.

## Cut Hose Length = Assembly Overall Length - (C1+C2)

C1 and C2 are cut-off factors for each end. The "C" dimension may differ for each end, depending on the fitting. In certain situations, the sealing surface of JIC swivels and O-ring face seals should be considered when calculating overall length.

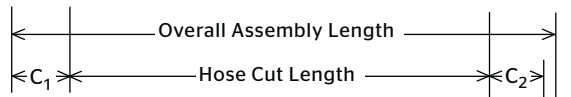

Hose assemblies should be manufactured to the following length tolerances.

Assembly Length	Tolerance (+/- in.)	Tolerance (+/- in.)	Tolerance (+/- mm)
Up through 12 in. (304.8mm)	0.13	1/8	3.2
Over 12 through 18 in. (304.8 through 457.2mm)	0.19	3/16	4.8
Over 18 through 36 in. (457.2 through 914.4mm)	0.25	1/4	6.4
Over 36 in. (914.4mm)	1%	1%	1%

\*SAE Dash Size equals OD of the tubing, which has approximately the same ID as the hose, expressed in 1/16".

## Measuring the Offset Angle

The offset angle between two fittings is the number of degrees measured in a clockwise direction between the fitting nearest the viewer and the farthest end fitting. Tolerances on the offset angle are +/- 3 degrees for assemblies up to 24 inches long and +/- 5 degrees for assemblies 24 inches and longer.

The following illustration shows the clockwise angle separation between a "close" fitting and a "far" fitting. The "close" fitting would be defined as the fitting closer when looking at an assembly end to end. The "far" fitting would be defined as the fitting on the far end of the assembly when looking at an assembly end to end. The far end is used as the reference point and the "close" end establishes the angular difference.

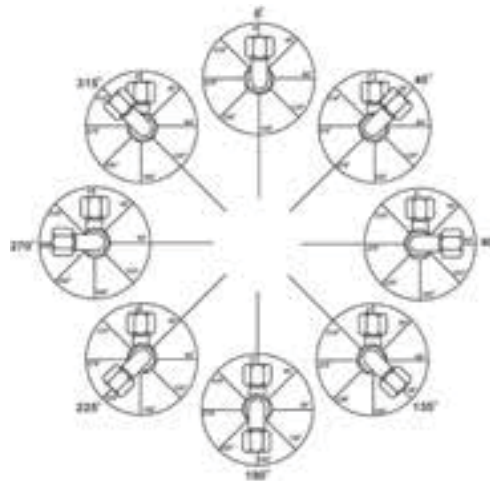

## Far End Reference Measuring Clockwise

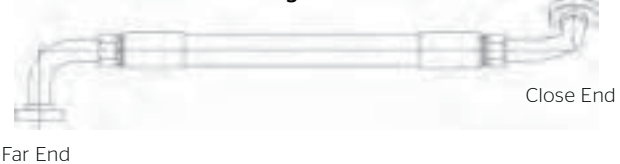

## Clockwise Measurement (Degrees)



## Steps in Hose Assembly



### Hose Assembly Instructions Ultra-Crimp™ 1-Piece Crimped Fittings

1. Determine correct hose length from desired hose assembly length and "C" dimension. The "C" dimension, or cut-off factor, can be found in the fitting tables. More information on using the "C" dimension can be found in the previous subtopic, "Defining Hose and Assembly Length."
2. Cut hose to required length using a cut-off saw or a circular abrasive cut-off wheel. The preferred choice would be the steel wheel with a cooling agent. Care should be taken in not overheating the hose, which can cause deformation of the hose and create difficulty when inserting the hose fittings. For textile-reinforced hose, a guillotine-style cutter may be used.



Cut-off saw. Use caution when operating power equipment. Follow the proper safety measures per manufacturer suggestions.

3. Ensure hose is cut squarely.
4. Contaminated hose may reduce the service life of hydraulic systems. Always clean the hose bore after cutting, using air and/or flush with a compatible fluid.

5. In certain situations, skiving may be required. Skiving is the process of removing the portion of hose cover that lies directly under the coupling ferrule. This allows the metal fitting to be coupled directly on the hose reinforcement. Skiving is further discussed in the following section under the subtopic of "Internal and External Skiving."

6. Push and seat hose into the fitting. It is essential that the fitting be mated with a compatible hose style. Check fitting compatibility in hose or fitting product tables. To determine the insertion depth of the hose coupling, first measure the distance from the bottom of the fitting to the end of the ferrule where the hose is to be inserted. Mark a line on the hose cover at the distance from the end of the hose that equals the insertion depth. This becomes the visual check to determine if the hose was fully inserted in the fitting.



Mark insertion depth.

It is sometimes difficult to insert a fitting into hydraulic hose. If necessary, it is recommended using a liquid soap or a water/soap solution as a lubricant. Use the lubricant sparingly. When installing elbow fittings, point elbow towards curvature of the hose, unless specified otherwise. When installing elbow fittings on both ends, see the previous section on "Measuring the Offset Angle." If the insertion mark was correctly applied, you should now be able to determine if the coupling has been completely inserted. The depth mark will be aligned with the end of the ferrule. In the case of a skived assembly, check that no skive shows and that couplings are on straight.



Hose with square cut.

## Steps in Hose Assembly



Fitting inserted on hose.

7. Before crimping hose fitting, verify the tooling setup and install the proper die set. Read the Crimp Chart, per Continental ContiTech recommendations, and dial in the correct crimp diameter.



Always verify proper die set.



Insert die set in crimper.

8. Place hose and fitting into the crimp machine. Crimp ferrule to predetermined diameter. Refer to the Continental ContiTech Crimp Specifications Manual for proper crimp diameters and the crimper operator's manual for further instructions on how to properly and safely operate the crimper.



Insert hose assembly into crimper die set.



Insert hose assembly into crimper die set.

9. Remove assembled end and check crimp diameter with caliper or micrometer. Crimp diameter should be measured at the center of the ferrule. Measure the smooth portion of the ferrule and not the ridges. Visually check for cracked, cocked or damaged fittings.



Set crimp diameter.



Verify crimp diameter with calipers.

## Steps in Hose Assembly

10. Some applications require the addition of a protective outer sleeving or strain reliefs. If this is a requirement, the most appropriate time to assemble is before the second end fitting is applied. Choose the appropriate product for the specific application. When cutting product to length, allow for flexing and bending of the hose.
11. Even if not required, it is a good practice to examine and audit the assembly before delivery or use. Records should be maintained. The level of inspection should be in compliance with the quality plan.
  - a) Inspection - Visual, dimensional and proof pressure testing in accordance with SAE J517 or SAE J343.
  - b) Clean or flush of the assembly to remove plating dust, rubber chips, etc.
  - c) Apply caps, if required, to protect fitting threads and keep out contamination.
  - d) Apply labels or specific markings, if required.
  - e) Package the assembly properly.

### Final Inspection Checklist

- › Bulge behind the fitting
- › Cocked fittings
- › Cracked fittings
- › Rusted fittings
- › Exposed reinforcement
- › Freedom of swivels
- › General appearance of the assembly
- › Internal contaminants
- › Restriction of the tube

### Recommended Inspection Equipment

- › Worktable suitable for inspection
- › Tape measure to measure overall length
- › Calipers for measuring crimp diameter
- › Pi tape to measure outside diameter
- › Plug gauges for measuring inside diameter
- › Protractor device for measuring angle orientation of bent tube fittings
- › Magnifying glass and light to view inside of assemblies
- › Burst and proof pressure tester



### Hose Assembly Instructions Uni-Crimp™ 2-Piece Crimped Fittings

1. Determine correct hose length from desired hose assembly length and "C" dimension. The "C" dimension, or cut-off factor, can be found in the fitting tables. More information on using the "C" dimension can be found in the previous subtopic, "Defining Hose and Assembly Length."
2. Cut hose to required length using a cut-off saw or a circular abrasive cut-off wheel. The preferred choice would be the steel wheel with a cooling agent. Care should be taken in not overheating the hose, which can cause deformation of the hose and create difficulty when inserting the hose fittings. For textile-reinforced hose, a guillotine-style cutter may be used.



Cut-off saw. Use caution when operating power equipment. Follow the proper safety measures per manufacturer suggestions.

3. Ensure hose is cut squarely.



Hose with square cut.

## Steps in Hose Assembly

4. Contaminated hose may reduce the service life of hydraulic systems. Always clean the hose bore after cutting, using air and/or flush with a compatible fluid.

5. In certain situations, skiving may be required. Skiving is the process of removing the portion of hose cover that lies directly under the coupling ferrule. This allows the metal fitting to be coupled directly on the hose reinforcement. Skiving is further discussed in the following section under the subtopic of "Internal and External Skiving."

6. The 2-piece crimped fitting consists of a ferrule and a stem insert. It is essential that the fitting be mated with a compatible hose style. Check fitting compatibility in hose or fitting product tables. Screw and/or push ferrule onto the hose until hose bottoms into the ferrule.



Push ferrule onto hose.

7. Push the stem insert into the hose ID. The shoulder of the stem should make contact with ferrule. It is sometimes difficult to insert the stem into hydraulic hose. If necessary, it is recommended using a liquid soap or a water/soap solution as a lubricant. Use the lubricant sparingly. When installing elbow fittings, point elbow towards curvature of the hose, unless specified otherwise. When installing elbow fittings on both ends, see the previous subtopic on "Measuring the Offset Angle."



Push stem into hose ID.

8. Before crimping hose fitting, verify the tooling setup and install the proper die set. Read the Crimp Chart, per Continental ContiTech recommendations, and dial in the correct crimp diameter.



Always verify proper die set.

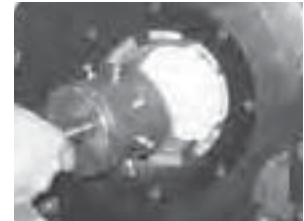

Install the proper die set.



Set crimp diameter.

9. Place hose and fitting into the crimp machine. Refer to the Continental ContiTech Crimp Specifications Manual for proper crimp diameters and the crimper operator's manual for further instructions on how to properly and safely operate the crimper.



Insert hose assembly into crimper die set.

## Steps in Hose Assembly



Crimp the hose/fitting assembly.

10. Remove assembled end and check crimp diameter with caliper or micrometer. Crimp diameter should be measured at the center of the ferrule. Measure the smooth portion of the ferrule and not the ridges. Visually check for cracked, cocked or damaged fittings.



Verify crimp diameter with calipers.

11. Even if not required, it is a good practice to examine and audit the assembly before delivery or use. Records should be maintained. The level of inspection should be in compliance with the quality plan.
- Inspection - Visual, dimensional and proof pressure testing in accordance with SAE J517 or SAE J343.
  - Clean or flush of the assembly to remove plating dust, rubber chips, etc.
  - Apply caps, if required, to protect fitting threads and keep out contamination.
  - Apply labels or specific markings, if required.
  - Package the assembly properly.

Refer to the Final Inspection Checklist and Recommended Inspection Equipment previously listed in "Hose Assembly Instructions Using a 1-Piece Crimped Fitting."

### Hose Assembly Instructions Field-Grip™ Fittings

Continental ContiTech Field-Grip™ reusable hose fittings must be carefully matched to Continental ContiTech hose. Use Field-Grip™ fittings only designed specifically for Continental ContiTech hose. Use the correct socket with a given hose. Specific fittings and their hose application can be found in the fitting tables.

- Determine correct hose length from desired hose assembly length and "C" dimension. The "C" dimension, or cut-off factor, can be found in the fitting tables. More information on using the "C" dimension can be found in the previous subtopic, "Defining Hose and Assembly Length."
- Cut hose to the required length using a cut-off saw or a circular abrasive cut-off wheel. The preferred choice would be a steel wheel with a cooling agent. Care should be taken in not overheating the hose, which can cause deformation of the hose, creating difficulty when inserting the hose fittings.



Cut-off saw. Use caution when operating power equipment. Follow the proper safety measures per manufacturer suggestions.

- Ensure hose is cut squarely.



Hose with square cut.

## Steps in Hose Assembly

- Contaminated hose may reduce the service life of hydraulic systems. Always clean the hose bore after cutting, using air and/or flush with a compatible fluid.
- A Field-Grip™ fitting consists of a socket and stem



Field-Grip™ fitting consists of a stem and a socket.

assembly. It is essential the fitting be mated with a compatible hose style. Check fitting compatibility in hose or fitting product tables. Place the socket in a vice. The socket will fit over the hose cover. To determine the insertion depth for the hose, first measure the distance from the bottom of the socket to the end of the socket where the hose is to be inserted. Transfer this insertion depth to the hose cover by measuring from the end of the hose. Mark a line on the hose cover at the distance from the end of the hose that equals the insertion depth. This becomes the visual check to determine if the hose was fully inserted in the socket.



Socket positioned in vice.



Mark Insertion depth.

- Lightly lubricate hose cover with a mild soap solution. Screw end of hose counterclockwise until hose reaches the marked insertion depth and then back off 1/2 turn. If the insertion mark was correctly applied to the hose, you should now be able to determine if the socket has been correctly applied to the hose by using the insertion depth mark on the hose cover as a reference along with a visual check inside the socket.



Apply lubricant to hose cover.



Visually check hose position inside socket.

- Lightly lubricate the inside of the hose and stem threads with a mild soap solution. Using a wrench, screw the stem assembly into the socket until the stem hex shoulders against the socket.



Apply lubricant to stem and hose tube.



Screw stem into socket.



Stem properly seated against socket.

- If disassembly is necessary, reverse the process.



## Internal and External Skiving

Skiving is the process of stripping and removing the hose cover to allow the proper installation of crimped hose ends and to ensure the best possible hose assembly.

1. At the point of skiving, the hose has been cut to the proper length. See Steps 1 and 2 in the previous hose assembly instructions.
2. Obtain length of skive per Continental ContiTech specifications. Mark hose with skive length.

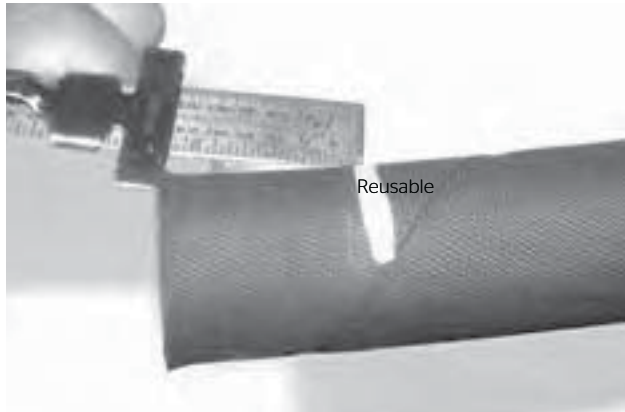

Mark skive on hose cover.

3. Remove the hose cover to the wire, using care not to burn, fray or damage reinforcement wires. The cover of wire-braided hoses can be removed with a buffing wheel or a hand skiver. A manual, external skiving tool that uses a knife must be used with spiral hose. Mark the length of the cover to be removed, as noted in the Continental ContiTech Crimp Specifications Manual, and set skiving depth on the manual skiving tool. Make sure the manual skiver is rotated in the counterclockwise direction for external skiving. Follow specific instructions on external skiving that would accompany the manual skiver.



Cutting skive with buffing wheel. Follow manufacturer's recommendation for the safe and proper use of the skiver.

4. With the hose cover removed, check that the wire braid or spiral reinforcement has not been displaced, damaged or cut in the skiving process.



Check skived hose.

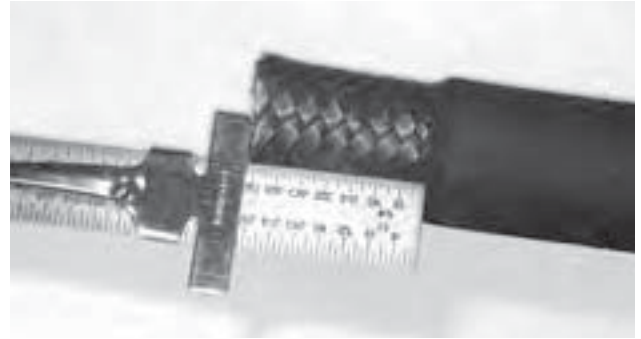

Measure skive.

5. Check for the proper skive length.
6. Hoses should be checked for 100% of cover removal. If necessary, rebuff skived area to clean and remove hose cover.
7. A manual, internal skiving tool that uses a knife is to be used to remove the tube material of spiral hose for installation of the Dual-Grip™ fittings. Note the correct length of tube material to be removed from the Continental ContiTech Crimp Specification Manual. Set the desired skiving depth on the internal skiving tool. Make sure the tool rotates in the clockwise direction for internal skiving. Verify that the correct length of tube material has been removed. Follow specific instructions on internal skiving that would accompany the manual skiver.
8. It is important to clean hose ID by brushing, blowing compressed air or flushing to remove any contaminants.

**Warning:** Failure to completely remove the cover may result in serious personal injury or property damage due to hose ends blowing off, leakage or other failures.

## Steps in SR14A Hose Assembly

In order to make a quality assembly with SR14A hose, the following instruction must be followed:

1. Tape hose before cutting as shown.

This will prevent the wire from flaring once the cut is made. If wire flare is allowed to occur, the ferrule will not slide onto the hose.

2. Slip ferrules on. Be sure they are in the correct direction (i.e. flange side aims to the outside of the hose).

3. Push in on stem on each end.

4. Remove the tape and slide the ferrule onto the stem.



## Steps in SR14A Hose Assembly

5. Crimp the fitting using proper die selection and setting. Be sure not to allow the ferrule to slip back onto the hose or ride up on the hub of the stem. The groove of the ferrule must line up with flange of the stem.

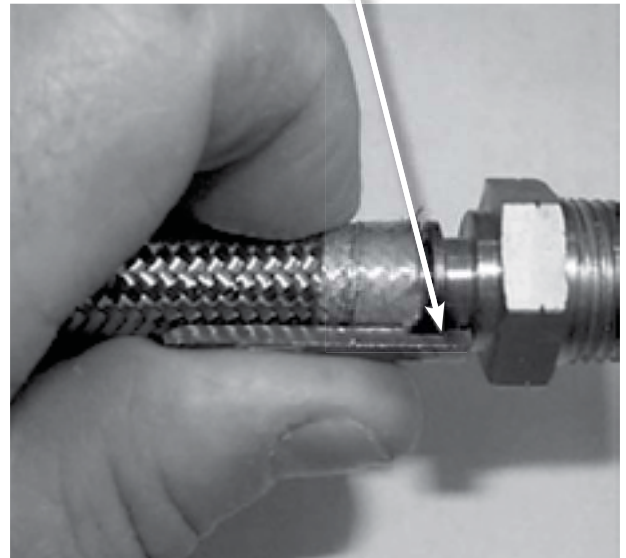
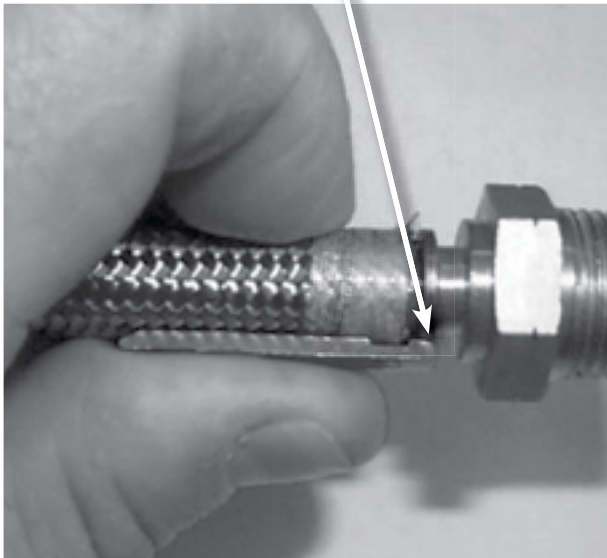
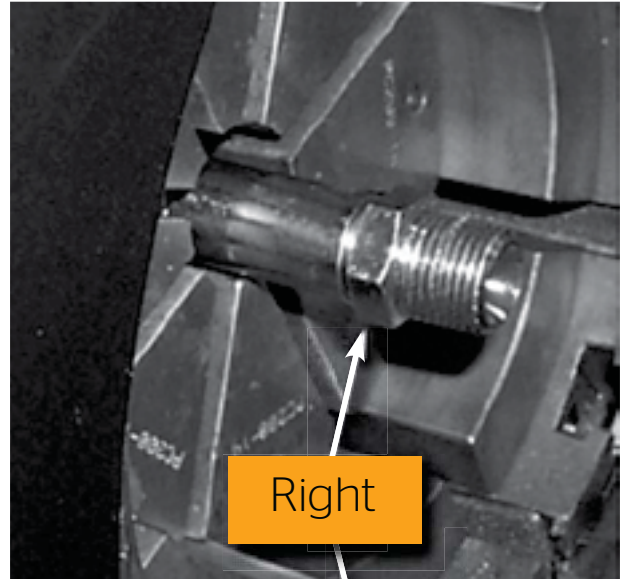
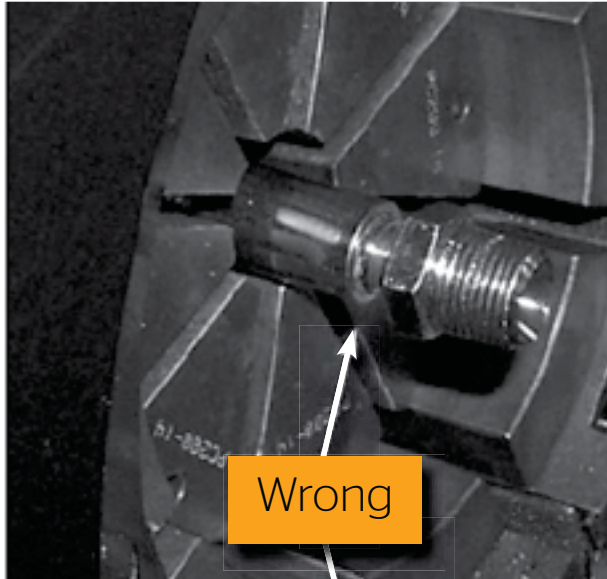

6. Check finished crimp diameter.



## Steps in Cool Clip® A/C Hose Assembly

Special care should be taken when selecting the proper refrigerant hose and fittings. Continental ContiTech Cool Clip® fittings should only be used with Continental ContiTech Galaxy® 4890 hose.

Special care must be taken when working with refrigerant systems. Sudden escape of refrigerant gases may result in blindness or severe injury. Continental ContiTech recommends adherence to guidelines and general practices as defined in SAE J2211 for the service containment of HFC-134a as well as all applicable EPA guidelines and procedures concerning the service of refrigerant systems.

### Steps in Cool Clip® A/C Hose Assembly

1. Cut the hose to proper length with the Continental ContiTech hose cutter PN 65090.



The cut must be made squarely to the hose length.

2. Install two proper-sized clips into the clipholder. For ease of assembly, both clips should have the same orientation.

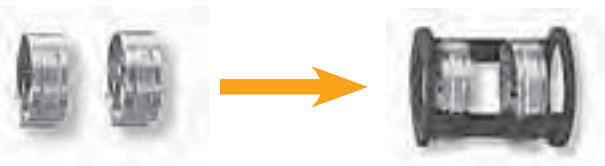

3. Place the clipholder with the two clips on the hose. Install the clipholder so that the end with the smallest hole touches the end of the hose.
4. Lubricate the fitting with a generous amount of the A/C system's lubricator oil. This is to lower the force of the insertion.

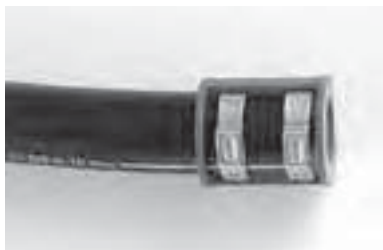

5. Insert the fitting into the hose. Ensure that the fitting is fully inserted so that there is no gap between the end of the hose, the clip retainer and the shoulder of the fitting.

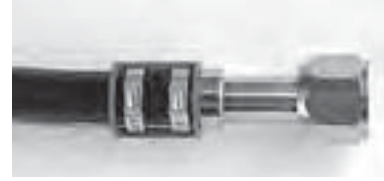

6. Close both clips with the Continental ContiTech clip pliers, PN GC-Pliers-0001. The pliers will automatically release when the clips have been completely closed. Start with the clip closer to the end of the hose.

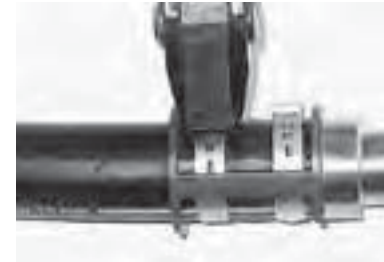

7. Now you have realized a durable hose/fitting connection.



### Warning - Selection of Fitting

Selection of the proper Continental ContiTech hose and fittings for the application is essential to the proper operation and safe use of the hose and related equipment. Inadequate attention to the selection of the hose and fitting for the application can result in hose leakage, bursting or other failures which can cause serious bodily injury or property damage from spraying fluids or flying projectiles. Some of the factors involved in the selection of the proper hose and fittings are:

#### Hose

- › Size › Refrigerant › Pressure › Length › Bends
- › Original Equipment

#### Fittings

- › Compatibility › Pressure › Temperature › Hose Size
- › Installation Design › Corrosion Requirements

If there are any questions as to what fitting should be used, Continental ContiTech recommends that you consult the local Sales Representative or Continental ContiTech Hydraulics Application Group for assistance.

## A/C Fitting Crimping Procedure for PC125 Crimper

1. Insert the pressure plate into the bottom flange of the crimper, making sure that it is seated completely into the bottom flange.



2. Select the correct die set for the Galaxy® hose dash size/ ID and "AC" fitting being crimped. Insert the two halves of the die set onto the pressure plate, making sure both halves are flat and level.

Galaxy® Hose # ID	PC125 Die Set
G4826-06 5/16"	PC125-AC06
G4826-08 13/32"	PC125-AC08
G4826-10 1/2"	PC125-AC12
G4826-12 5/8"	PC125-AC12
G4867-14 3/4"	PC125-AC12



### Be Sure To:

Lubricate the contact surfaces: both bottom and outside edges of the die fingers, the inside of the compression ring and the pressure plate with the die lubricant provided with the crimper. Only use a molybdenum/graphite high-pressure grease applied sparingly to the contact surfaces. Die lubricant can be obtained from Continental ContiTech using part numbers PC900-Grease (3 oz.) or PC900-Grease (1 lb.) An aerosol lubricant, PC900-AerosolLube, can also be used.

**Failure to lubricate the contact surfaces with the correct lubricant will cause the dies to seize in the compression ring, causing damage to the die set as well as possibly damaging the crimper.**

3. Place the compression ring loosely but evenly over the die set. Make sure die set is correctly aligned.

4. Slide the pusher in place.



5. Set the micrometer to the setting as shown in the Continental ContiTech Crimp Specification Manual for the combination of hose and fitting being crimped. The metric micrometer (readings of 0 to 10) is a direct reading micrometer. The setting on the micrometer is added to the number in millimeters etched on the die ring to obtain the final crimp diameter. The adjuster, set at "0," is the setting for the die set fully closed. For example, with a 34mm die and the micrometer set at 3.0mm, the finished crimp diameter would be 37.0mm (34mm + 3.0mm).

6. Attach the coupling stop, included with your crimper, to the base of the crimper.



7. Select the appropriate Galaxy® hose size and cut to the correct length using Continental ContiTech Hose Cutting Tool (part #65090). Be sure the hose is cut squarely at a 90-degree angle to the hose.

8. Insert the hose end fully into the ferrule of the corresponding fitting. When completely inserted, the hose should be visible through the witness hole on the side of the ferrule.



## A/C Fitting Crimping Procedure for PC125 Crimper

9. Insert the hose and fitting through the crimp dies. Align the foot on the coupling stop so that the foot rests on the top of the crimp die and also against the end of the fitting ferrule. Be sure the foot on the coupling stop is against the end of the ferrule and not resting on the bump of the tube above the ferrule.

10. Manually depress the compression ring, closing the die set until the hose and fitting are held loosely in the die set. Seat the compression ring evenly on the die set



Each die set has a limited range of diameters for which a satisfactory crimp can be obtained.

Always consult the Continental ContiTech Crimp Specification Manual for selecting the correct die set.

**CAUTION:** The notches on the die set must be completely covered by the compression ring prior to starting the crimp. If the notches are showing, you must go to a larger die set. Crimping with an incorrect die size could result in personal injury.



11. Recheck the fitting for the correct alignment in the die set and depress the start/stop switch. Hold the start/stop switch until the automatic stop switch shuts the pump off. Release the start/stop switch and allow the pusher to return to the retracted position.



12. Check the crimp diameter of the finished assembly with a caliper or micrometer to be certain that it is within the specifications as outlined in the Continental ContiTech Crimp Specification Manual. The caliper measurement should be taken in the crimp groove between the ridges as shown.

NOTE: To properly measure the crimp diameter on "AC" style fittings, your caliper should be a style having notched blades as shown here:



13. Check the completed assembly to be sure that the hose is still visible through the witness hole on the fitting. Also, the crimp grooves should be centered on the fitting ferrule.



If the crimp grooves are too near the fitting end of the ferrule, or too near the hose end of the ferrule, the fitting may not seal properly and the assembly could leak. If your finished crimp assembly resembles either of the two examples shown below, the end of the ferrule was not properly positioned against the coupling stop foot, or the coupling stop foot was not resting on the top of the die set when crimped. A new assembly should be crimped, being sure to follow the procedures in Step 9.





# Installation & Maintenance

## Service Life Factors

Hose and hose assemblies have a finite life. There are a number of factors that will reduce hose life. Consideration should be given to the following factors.

1. **Operating Pressure** - The maximum operating pressure within the hose should not exceed the recommended working pressure as specified by Continental ContiTech as shown in the catalog specifications. Hose selection must be made so that the recommended maximum operating pressure is equal to or greater than the system pressure. Burst pressure, which is four times the working pressure, should not be used as the operating pressure of the hose. Exposing the hose to pressures higher than the working pressure is dangerous and will shorten hose life.
2. **Exposing the hose to a surge pressure**, above the working pressure of the hose, will shorten hose life. If surges are severe, select a hose with a higher recommended working pressure.
3. **Burst Pressure** - The burst pressure should never be considered in a hydraulic system design. The burst pressure is for test purposes only. Burst pressure is detrimental to the hose.
4. **Operating Temperatures** - High heat conditions may have an adverse affect on hose due to the degradation of the rubber and the affect on fitting retention. Continuous use at or above the maximum operating temperature of the hose will cause deterioration of the tube, cover and reinforcement, reducing the hose life. Care should be taken to ensure that fluid and ambient temperatures, both static and transient, do not exceed the limitations of the hose. It is important to operate a hose assembly within the specified temperature range of the specific hose.
5. **Bend Radius** - Flexing the hose to less than its recommended minimum bend radius will decrease hose life. Optimize routing to minimize inherent problems.
6. **Excessive external forces** such as flexing, twisting or kinking will reduce hose life. Use the correct fitting or adapter to prevent any unnecessary external force.
7. **Chemical Resistance** - Consider the chemical resistance of the tube, cover and the fitting, including the O-ring, to maximize hose performance and life. Hose selection must assure compatibility of the hose, tube, cover and fittings with the fluid used.
8. The size of the hose assembly components must be adequate to keep pressure losses to a minimum and avoid damage to the hose due to heat generation or excessive turbulence.
9. Extend hose assembly life by making sure hose and fittings are compatible with the environment or sufficiently protected from the elements, such as ultraviolet light, ozone, salt water or chemicals that can cause degradation of assembly components and shorten hose life.
10. A hose is designed with a certain level of abrasion resistance, but care should be taken to avoid excessive abrasion, which can damage the hose cover, accelerating hose failure.
11. Use the proper end fittings and crimp or install to the proper crimp specification to ensure a safe and proper hose assembly. Make sure that hose fittings are compatible with the hose.



## Safety Considerations

Fabricators, end users and installers should be aware of the safety factors when handling or when in proximity of hydraulic hose assemblies. The following are some potential conditions that can lead to personal injury and property damage.

1. As certain fluids may permeate the hose cover, the hose should always be used in well-ventilated areas.
2. Hydraulic systems generally operate at very high pressures. Any leak of pressurized fluid can penetrate the skin, causing severe tissue damage and burns. Consider the use of guards or shields around the hose assembly to reduce the risk of injury.
3. Whipping Hose - Under high operating pressures, the hose and/or fitting can come loose or blow, causing the end of the hose to whip with great force. Again, the hose assembly should be shielded or guarded, even possibly secured, to avoid injury or damage from this whipping action.
4. Hydraulic fluids are flammable and can explode with a source of ignition. To avoid possible injury or property damage, care should be taken to eliminate ignition sources and to properly route the hose assembly to minimize the chance of combustion.
5. Most all hose is conductive. In some cases a non-conductive hose is required. To avoid electrocution or other serious mishap, the correct hose specification, either conductive or nonconductive, should be used.
6. Should a hydraulic hose assembly fail, loss of hydraulic pressure will affect the operation of equipment. Care should be taken that a sudden power loss of the equipment will not cause personal injury.
7. When air or gaseous materials are being conveyed, the correct hose should be used. A pin-perforated cover may be required. Perforations in the cover will prevent permeated gases from accumulating and blistering the cover. Check Continental ContiTech for the correct hose specification.
8. Extreme care should be used when operating handheld hydraulic tools where the operator is in proximity to the hydraulic hose assembly. The following steps should be taken to avoid injury.
  - a. Use strain relievers on each end of the hose to prevent kinking, excessive bending or stress on the hose at the coupling.
  - b. Never use the hose assembly to pull or carry the tool.
  - c. Exposed hose near the operator should be guarded in case hose assembly fails, to prevent injury from high pressure or high temperature fluid.
  - d. Operators of the tool should be protected with the required safety clothing, considering the job and fluids being used.
  - e. The hose should be protected against any external damage.
9. Hose assemblies should be properly routed to avoid strain and the possibility of the hose bursting. Proper routing will also protect the assembly against flex fatigue, excessive heat or abrasion.
10. When selecting a hose style and assembly, check for hose compliance to all relevant government, industry and safety standards or regulations.

## Proper Installation & Hose Routing

### Proper Hose Installation

**Warning:** Improper selection, installation or maintenance of a hose assembly may result in premature failures, bodily injury or property damage.

The following practices should be used when replacing a hydraulic hose assembly or installing a new hydraulic assembly.

1. A pre-installation inspection should include the following:
  - a. Check to ensure the hose is the correct specification in style, size and length.
  - b. Check that the hose assembly has no visible non-conformity.
  - c. Check fittings for any damage including nicks or burrs.
  - d. Check that the hose is routed properly using suggested guidelines.
  - e. Check that the hose is not damaged (kinked, crushed, twisted).
2. Handle assembly with care. Avoid bending hose beyond the recommended bend radius.
3. Hose assemblies should not be installed in a torqued or twisted condition.
4. Use necessary restraints and protective devices when necessary to reduce wear and stress points on the assembly.

### Correct Assembly Installation & Routing

Satisfactory performance and appearance depend upon proper hose installation. Excessive length destroys the trim appearance of an installation and adds unnecessarily to the cost of the equipment. Hose assemblies of insufficient length to permit adequate flexing, expansion or contraction will cause poor power transmission and shorten the life of the hose.

The diagrams below offer suggestions for proper hose installations to obtain the maximum in performance and economy.

Since hose may change in length from +2% to -4% under the surge of high pressure, provide sufficient slack for expansion and contraction.

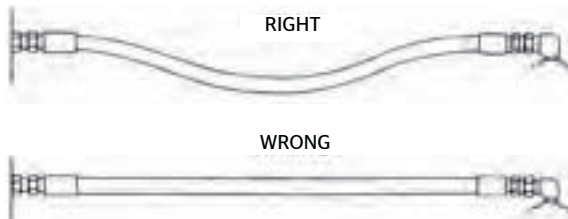

Obtain direct routing of the hose through use of 45° and 90° adapters and fittings. Improve appearance by avoiding excessive hose length.

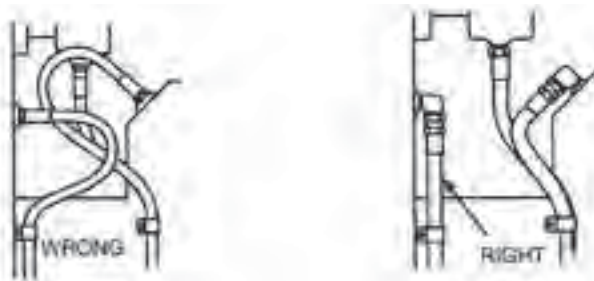

Avoid sharp twist or bend in hose by using proper angle adapters compatible with the hose.



# Proper Installation & Hose Routing

Due to changes in length when the hose is pressurized, do not clamp at bends so the curves can absorb changes and protect the hose with a spring guard. Do not clamp high and low pressure lines together, and protect the hose with a spring guard.

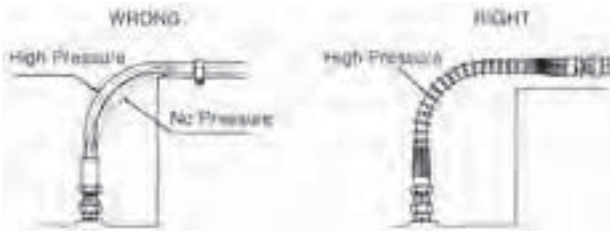

Where the radius falls below the required minimum, an angle adapter should be used as shown on previous page to avoid sharp bends in the hose.

Adequate hose length is most important to distribute movement on flexing applications and to avoid abrasion.

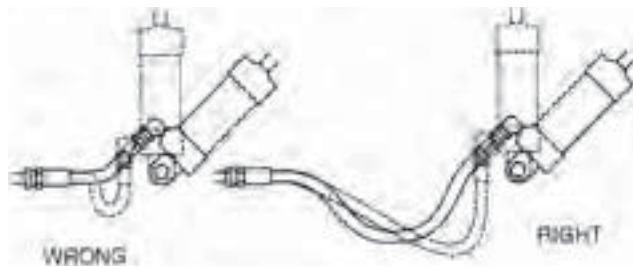

To avoid twisting in hose lines bent in two planes, clamp hose at change of plane, as shown.

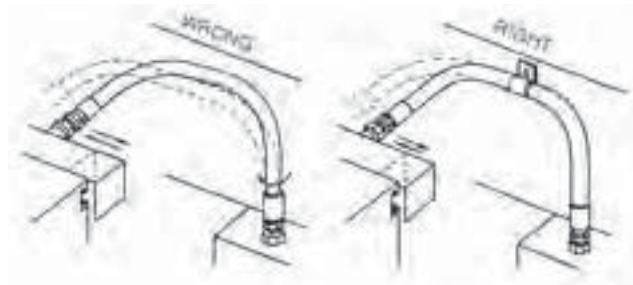

Hose should not be twisted. Hose is weakened when installed in a twisted position. Also, pressure in twisted hoses tend to loosen fitting connections. Design so that machine motion produces bending rather than twisting.



To prevent twisting and distortion, the hose should be bent in the same plane as the motion of the boss to which the hose is connected.

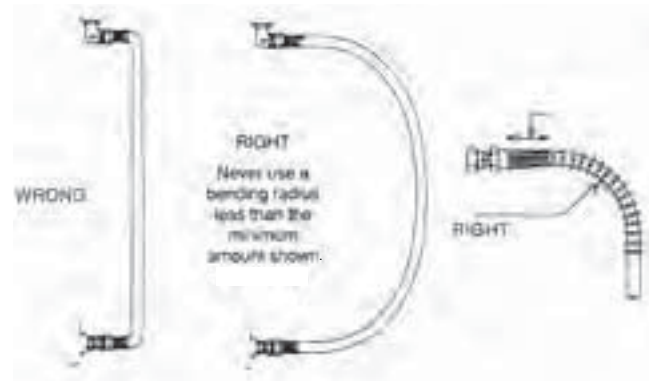

Never use a bending radius less than the minimum shown in the hose specification tables. To reduce collapsing of line and restriction of flow, avoid a sharp bend in the hose by using proper spring guard. Exceeding minimum bend radius will greatly reduce hose assembly life.

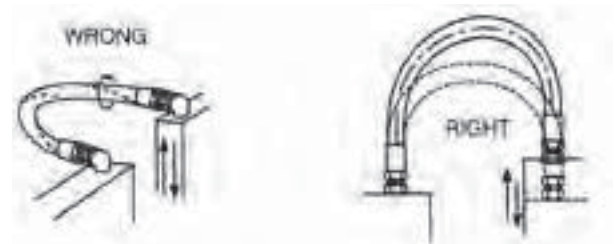

# Hose Maintenance & Storage

## Hose Maintenance

A hose and fitting maintenance program can reduce equipment downtime and maintain peak operating performance of the hydraulic system. Here are a few maintenance reminders.

1. Hose assemblies should be inspected on a regular basis with frequency based on prior history of the equipment, a set maintenance/inspection program, and the severity of the application or risk potential.
2. Always use Safety Considerations (page 618) when inspecting hose assemblies. To avoid personal injury during system checkouts, do not touch the assembly and be aware of the potentially hazardous area surrounding the hose assembly.
3. Inspect hose and fittings for the following:
  - a. Exposed, broken or corroded reinforcement wires.
  - b. Leaks in the hose or at the fitting.
  - c. Cracked, damaged or corroded fittings.
  - d. Other signs of significant deterioration.

If any of the above conditions exist, the hose assembly should be replaced immediately.

4. The hydraulic system should also be inspected for the following:
  - a. Leaking ports.
  - b. Damaged or missing hose clamps, guards or shields.
  - c. Excessive dirt or grease on the assembly.
  - d. Condition of system fluid, fluid temperature, contamination and air entrapment.

If any of the above conditions are found, appropriate corrective action should be taken.

5. Functional tests should be conducted to determine if systems are leak-free and operating properly.

6. If hose assembly can be inspected and detached from the hydraulic system, additional steps can be taken to ensure a properly maintained assembly.
  - a. With hose assembly detached, clean assembly by blowing out with clean, compressed air or rinsed with a compatible cleaning fluid.
  - b. Inspect hose tube for cuts, obstructions and cleanliness.
  - c. Check layline of the hose to make sure the hose is not twisted.
  - d. Check fittings to ensure they are in good condition and properly crimped or attached to the assembly.

If any of the above conditions are found, the hose assembly should be replaced.

7. The hose assembly should be hydrostatically tested, using the approved test stands and procedures as outlined in SAE J517. Test at proof pressure, or twice the working pressure of the hose, for 30 seconds to one minute. When test pressure is reached, visually inspect the hose for any signs of weakness, leaks or any hose movement relative to the fitting that would indicate a loose fitting. If any of these conditions exist, the assembly should be replaced.
8. Specific hose assembly replacement intervals must be considered based on previous service life, government or industry recommendations, or when failures could result in injury risk or property damage.

## Hose Storage

Temperature, humidity, ozone, sunlight, oils, solvents, corrosive liquids, insects, rodents and radioactive materials can adversely effect hose products. Hose should be stored in a dark, dry atmosphere away from heat sources, electrical equipment and the above adverse elements. The ideal storage temperature for rubber hose is 50°F to 70°F (10°C to 21.1°C), with a maximum of 100°F (37.8°C).



# Appendix

## Fitting Identification

### Measuring Threads and Seat Angles

Tools required: ID/OD Calipers, Seat Angle Gauge (English and Metric), Thread Pitch Gauge

#### Measuring Threads

A caliper is used to measure the OD of male threads and the ID of female threads. Measure at the largest point. In some cases, threads may be worn, and the exact measurement taken may not match exactly to the thread charts. For accuracy, it is recommended the male thread be measured.

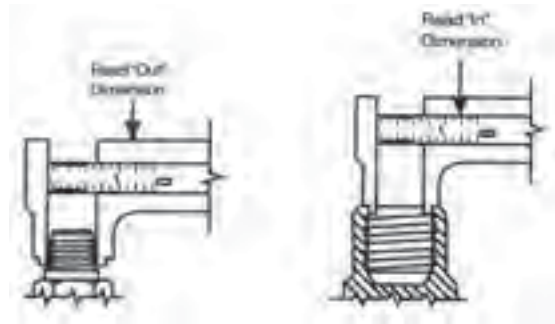

#### Measuring Seat Angle

A Seat Angle Gauge is used to measure the angle of the sealing surface. For either male or female fittings, place the gauge on the sealing surface. An accurate reading is taken when the gauge is parallel to the centerline of the coupling.

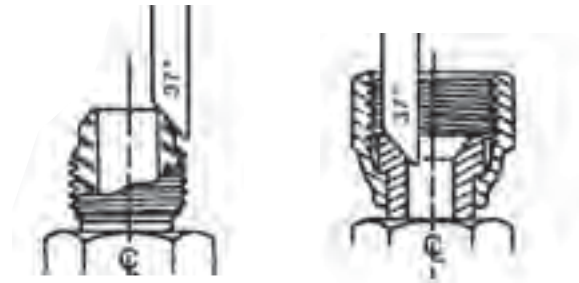

#### Measuring Thread Pitch

A Thread Pitch Gauge is used to determine the number of threads per inch or the distance between threads in a metric connection. To ensure an accurate reading, make sure the fit of the thread gauge is snug.

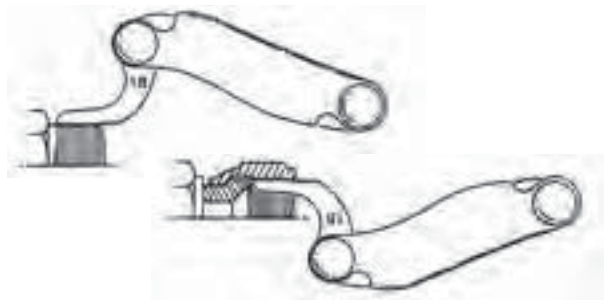

#### Comparing Measurements to the Tables

ID/OD measurements, thread pitch and seat angle will be used to identify the fitting. Measurements taken can be used to compare with the dimensions found on charts in the following pages.

As an example, a fitting will be defined as: Continental ContiTech B2-NPMX-0606 with 3/8-18 threads.

From the hydraulic catalog, the fitting can be identified as a NPTF/MALE/Swivel.

The -6 fitting has 3/8-18 threads, which can be identified using calipers, thread gauge and the following tables.

# Fitting Identification

## Fitting Standards

There are five basic fitting standards. They are identified as North American, British, French, German and Japanese.

### North American Thread Types

Also known as American Dryseal Pipe Threads, the thread types include NPTF, NPSF and NPSM.

- N** - National
- F** - Fuels
- T** - Tapered Thread
- S** - Straight Thread
- P** - Pipe
- M** - Mechanical Joint

Pipe threads can be either straight or tapered. The first step in identifying this fitting is to determine if the thread is parallel (straight) or tapered.



Parallel Threads

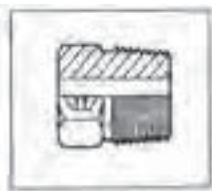

Tapered Threads

A straight thread is not used for sealing fluids. In this type of fitting, a seal is achieved with an O-ring, a metal seal, or a seat machined into the end of the fitting. A straight thread can be determined by laying a straightedge against the threads. If all the threads are parallel to the centerline of the fitting, then it is a straight thread.

A tapered thread seals by the interference in the engagement of the male and female threads. These threads deform when they are tightened, causing metal deformation and a pressure-tight joint. Thread sealants are commonly used in this connection. A tapered thread can be determined by laying a straightedge against the threads. If the straightedge is not parallel to the centerline of the fitting and the threads taper towards the centerline of the fitting, then it is a tapered thread.

A fitting may also be referred to by its Dash number. The Dash number is a universal abbreviation for sizing pipe systems. The following charts will show a Dash number for each fitting. The Dash number comes from the dimension of the port of the fitting. It is the dimension in 1/16 of an inch. A 3/8" port would be 6/16" or a Dash 6 (-6).

Inch	1/16	SAP #
1/8	2/16	-2
1/4	4/16	-4
3/8	6/16	-6
1/2	8/16	-8
3/4	12/16	-12
1	16/16	-16
1 1/4	20/16	-20
1 1/2	24/16	-24
2	32/16	-32

### NPTF

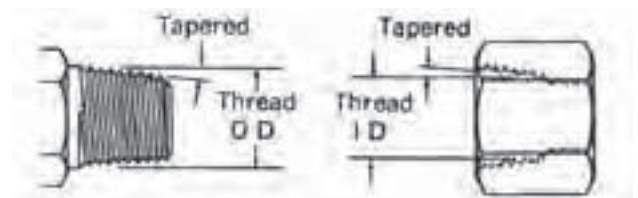

Male

Female

#### Identification

National Pipe Tapered Fuels. Tapered thread.

#### Seal

The thread is tapered and sealing takes place with the deformation of the threads. The NPTF male has a 30-degree seat and will mate with the NPTF female, also with tapered threads, but no seat. A thread sealant is commonly used. An NPTF male with 30-degree seat will mate with an NPSM female, which has straight threads and a 30-degree inverted seat. The sealing takes place on the 30-degree seat.

#### Application

The NPTF fitting is a dryseal thread, commonly used in fluid power systems but not recommended by the National Fluid Power Association for hydraulic applications.

# Fitting Identification

## Fitting Standards

### NPSM

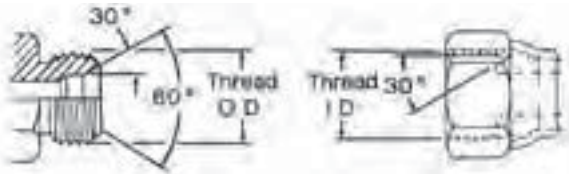

Male

Female

#### Identification

National Pipe Straight Mechanical. Straight thread.

#### Seal

Both male and female have a straight thread and 30-degree seat and chamfer. The seal takes place by compression of the 30-degree seat on the chamfer. The threads hold the connection mechanically.

#### Application

Used in fluid power systems.

#### Thread Identification Table

NPTF/NPSF/NPSM

Dash Size	Nominal Size	Thread Size	Female Thread ID	Male Thread OD
	in.		in.	in.
-2	1/8	1/8 - 27	23/64	13/32
-4	1/4	1/4 - 18	15/32	35/64
-6	3/8	3/8 - 18	19/32	43/64
-8	1/2	1/2 - 14	3/4	27/32
-12	3/4	3/4 - 14	61/64	11/16
-16	1	1 - 11½	113/64	15/16
-20	1¼	1¼ - 11½	117/32	143/64
-24	1½	1½ - 11½	125/32	129/32
-32	2	2 - 11½	2¼	2¾

### SAE Thread Types

#### JIC 37° Flare (SAE J514)

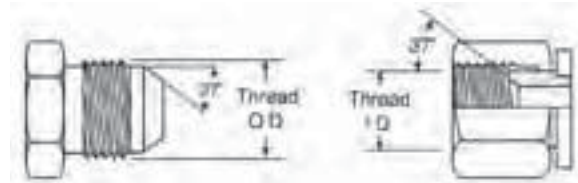

Male

Female

#### Identification

Straight threads. Both male and female have 37-degree seat.

#### Seal

The seal is made on the 37-degree flare seat. The threads hold the connection mechanically. Only connect male SAE 37 with female SAE 37.

#### Application

SAE specifies use with high-pressure hydraulic tubing.

#### Thread Identification Table

JIC 37° Flare

Dash Size	Nominal Size	Thread Size	Female Thread ID	Male Thread OD
	in.		in.	in.
-2	1/8	5/16-24	17/64	5/16
-3	3/16	3/8-24	21/64	3/8
-4	1/4	7/16-20	25/64	7/16
-5	5/16	1/2-20	29/64	1/2
-6	3/8	9/16-18	1/2	9/16
-8	1/2	3/4-16	11/16	3/4
-10	5/8	7/8-14	13/16	7/8
-12	3/4	11/16-12	31/32	11/16
-14	7/8	13/16-12	17/64	13/16
-16	1	15/16-12	115/64	15/16
-20	1¼	15/8-12	135/64	15/8
-24	1½	17/8-12	151/64	17/8
-32	2	21/2-12	227/64	21/2



# Fitting Identification

## Fitting Standards

### SAE 45° Flare (SAE J512)

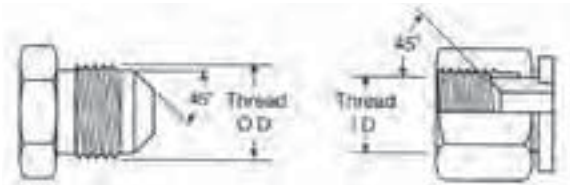

Male

Female

#### Identification

Straight threads. Both male and female have 45-degree seat.

#### Seal

The seal is made on the 45-degree flare seat. The threads hold the connection mechanically. Only connect male SAE 45 with female SAE 45.

#### Application

Commonly used in low-pressure, refrigeration and automotive piping systems and are frequently constructed of brass and connected to copper tubing.

#### Comments

Use caution when identifying this fitting as the threads are the same as SAE J512 37-degree (JIC), in -2, -3, -4, -5, -8 and -10 sizes. The sealing surface angles are different, however.

#### Thread Identification Table

SAE 45° Flare

Dash Size	Nominal Size	Thread Size	Female Thread ID	Male Thread OD
	in.		in.	in.
-2	1/8	5/16-24	17/64	5/16
-3	3/16	3/8-24	21/64	3/8
-4	1/4	7/16-20	25/64	7/16
-5	5/16	1/2-20	29/64	1/2
-6	3/8	5/8-18	9/16	5/8
-7	7/16	11/16-16	5/8	11/16
-8	1/2	3/4-16	11/16	3/4
-10	5/8	7/8-14	13/16	7/8
-12	3/4	1 1/16-14	63/64	1 1/16

### O-Ring Boss Straight Thread (SAE J514)

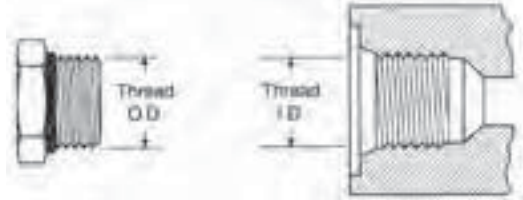

Male

Female

#### Identification

Male fitting has a straight thread and an O-ring. The female port has a straight thread and a chamfer to accept the O-ring.

#### Seal

The seal takes place by compressing the O-ring into the chamfer. The threads hold the connection mechanically. Only connect O-ring boss male with O-ring boss female.

#### Application

Recommended by the National Fluid Power Association for optimal leakage control in medium- and high-pressure hydraulic systems.

#### Thread Identification Table

Straight Thread O-Ring Boss

Dash Size	Nominal Size	Thread Size	Female Thread ID	Male Thread OD
	in.		in.	in.
-2	1/8	5/16-24	17/64	5/16
-3	3/16	3/8-24	21/64	3/8
-4	1/4	7/16-20	25/64	7/16
-5	5/16	1/2-20	29/64	1/2
-6	3/8	9/16-18	1/2	9/16
-8	1/2	3/4-16	11/16	3/4
-10	5/8	7/8-14	13/16	7/8
-12	3/4	1 1/16-12	31/32	1 1/16
-14	7/8	1 3/16-12	17/64	1 3/16
-16	1	1 5/16-12	1 15/64	1 5/16
-20	1 1/4	1 5/8-12	1 35/64	1 5/8
-24	1 1/2	1 7/8-12	1 51/64	1 7/8
-32	2	2 1/2-12	2 27/64	2 1/2

# Fitting Identification

## Fitting Standards

### O-Ring Face Seal (SAE J1453 ORS/ORFS)

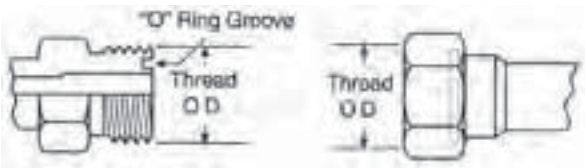

Male

Female

#### Identification

Male fitting has a straight thread and an O-ring. Female has a straight thread and a machined flat face.

#### Seal

The seal takes place by compressing the O-ring onto the flat face of the female. The threads hold the connection mechanically.

#### Application

Fittings are intended for hydraulic systems where elastomeric seals are accepted to overcome leakage and leak resistance. This connection offers the very best leakage control.

#### Thread Identification Table

O-Ring Face Seal (ORFS)

Dash Size	Nominal Size	Thread Size	Female Thread ID	Male Thread OD
	in.		in.	in.
-4	1/4	9/16-18	1/2	9/16
-6	3/8	11/16-16	5/8	11/16
-8	1/2	13/16-16	3/4	13/16
-10	5/8	1-14	15/16	1
-12	3/4	13/16-12	11/8	13/16
-16	1	17/16-12	111/32	17/16
-20	1 1/4	111/16-12	119/32	111/16
-24	1 1/2	2-12	129/32	2

### SAE J514 Flareless Tube Fitting

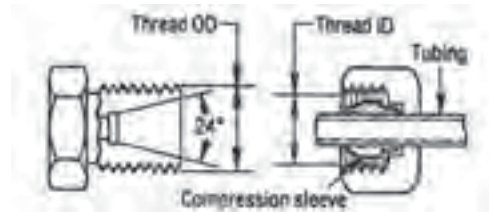

Male

Female

#### Identification

Male and female have straight threads. Male has 24-degree seat.

#### Seal

Female includes a compression sleeve for the sealing surface. A seal is formed with the compression sleeve as the female nut is tightened onto the male thread. A seal is formed between the compression sleeve, the male 24-degree seat and tubing.

#### Application

Used to adapt steel tubing to a hydraulic hose assembly.

#### Thread Identification Table

Flareless Tube Fitting

Dash Size	Tube Size	Nominal Size	Thread Size	Female Thread ID	Male Thread OD
	in.		in.	in.	in.
-2	1/8	5/16	5/16-24	17/64	5/16
-3	3/16	3/8	3/8-24	21/64	3/8
-4	1/4	7/16	7/16-20	25/64	7/16
-5	5/16	1/2	1/2-20	29/64	1/2
-6	3/8	9/16	9/16-18	1/2	9/16
-8	1/2	3/4	3/4-16	11/16	3/4
-10	5/8	7/8	7/8-14	13/16	7/8
-12	3/4	1 1/16	1 1/16-12	31/32	1 1/16
-14	7/8	1 3/16	1 3/16-12	17/64	1 3/16
-16	1	1 5/16	1 5/16-12	1 15/64	1 5/16
-20	1 1/4	1 5/8	1 5/8-12	1 35/64	1 5/8
-24	1 1/2	1 7/8	1 7/8-12	1 51/64	1 7/8
-32	2	2 1/2	2 1/2-12	2 27/64	2 1/2

# Fitting Identification

## Fitting Standards

### Code 61/Code 62/Caterpillar® Flange (SAE J518)



Male

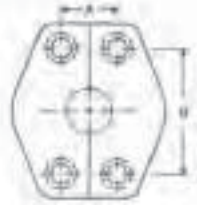

4-Bolt Split Flange

#### Identification

The female port is an unthreaded hole surrounded with 4 bolt holes in a rectangular pattern. The male consists of a flanged head, grooved for an O-ring and a flange with holes to match the port.

#### Seal

The seal takes place on the O-ring, which is compressed between the flanged head and the flat surface surrounding the port. The threaded bolts hold the connection mechanically.

#### Application

Commonly used in fluid power systems, worldwide, and usually in connection on pumps and motors. The fitting is available in two pressure ratings. Code 61, Form R, PN 35/350 bar, Type I is referred to as the “standard” series and can withstand an operating pressure of 3,000–5,000 psi depending on size. Code 62, Form S, PN 415 bar Type II is the heavy-duty, 6,000 psi series. While the design is the same, bolt hole spacing and flanged head diameters are larger for the higher pressure Code 62 fitting.

#### Comments

SAE J518, DIN 20066, ISO/DIS 6162 and JIS B 8363 are interchangeable except for the bolt sizes. The -10 is not available as an SAE standard size. Caterpillar® flanges, which have the same flange OD as SAE Code 62, have a thicker flange head, which is the “C” dimension in the table.

#### How to Measure

1. Measure port hole diameter [nominal flange size (in.)] using calipers.
2. Measure the longest bolt hole spacing from center to center, which is Dimension “B.”
3. Or the flange OD for further identification.

### Thread Identification Table

Code 61/Code 62/CAT®

Nominal Flange Size	Code 61			
in.	Flange OD	A	B	C
1/2	1.188	0.688	1.500	0.265
5/8	1.345			0.265
3/4	1.500	0.875	1.875	0.265
1	1.750	1.031	2.062	0.315
1¼	2.000	1.188	2.312	0.315
1½	2.375	1.406	2.750	0.315
2	2.812	1.688	3.062	0.375
2½	3.312	2.000	3.500	0.375
3	4.000	2.438	4.188	0.375
3½	4.500	2.750	4.750	0.422
4	5.000	3.062	5.125	0.442
5	6.000	3.625	6.000	0.442

Nominal Flange Size	Code 62			
in.	Flange OD	A	B	C
1/2	1.250	0.718	1.594	0.305
3/4	1.625	0.937	2.000	0.345
1	1.875	1.093	2.250	0.375
1¼	2.125	1.250	2.625	0.405
1½	2.500	1.437	3.125	0.495
2	3.125	1.750	3.812	0.495

Nominal Flange Size	Caterpillar® Code 62			
in.	Flange OD	A	B	C
3/4	1.625	0.938	2.000	0.560
1	1.875	1.094	2.250	0.560
1¼	2.125	1.250	2.625	0.560
1½	2.500	1.438	3.125	0.560
2	3.125	1.750	3.812	0.560

# Fitting Identification

## Fitting Standards

### SAE 45° Inverted Flare (SAE J512)

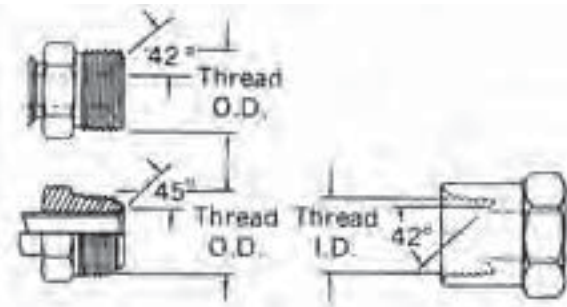

Male

Female

#### Identification

Male fitting, with a straight thread, can either be a 45-degree flare as a tube fitting or a 42-degree seat as a machined adapter. The female has a straight thread and a 42-degree inverted flare.

#### Seal

The seal takes place on the flared surfaces. The threads hold the connection in place mechanically.

#### Application

Fitting is frequently used in automotive systems.

#### Thread Identification Table

Table: SAE 45° Inverted Flare

Dash Size	Nominal Size	Thread Size	Female Thread ID	Male Thread OD
	in.		in.	in.
-2	1/8	5/16-28	9/32	5/16
-3	3/16	3/8-24	21/64	3/8
-4	1/4	7/16-24	25/64	7/16
-5	5/16	1/2-20	29/64	1/2
-6	3/8	5/8-18	37/64	5/8
-7	7/16	11/16-18	5/8	11/16
-8	1/2	3/4-18	45/64	3/4
-10	5/8	7/8-18	13/16	7/8
-12	3/4	1 1/16-16	1	1 1/16

### SAE J1467 Clip Fastener

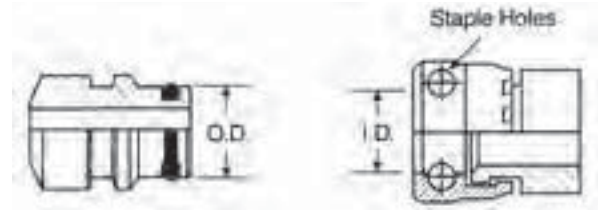

Male

Female

#### Identification

The male has an external O-ring with a groove to accept a clip. The female has a smooth bore with two holes to accept a "U" shaped clip. With the male fitting inserted into the female fitting, a clip is inserted through the two holes, locking the connection together.

#### Seal

The seal is formed between the O-ring on the male fitting and the smooth bore of the female fitting.

#### Application

Commonly used for hydraulic application in underground mines.

#### Thread Identification Table

SAE J1467 Clip Fastener

Dash Size	Nominal Size	Female Thread ID	Male Thread OD
	in.	in.	in.
-4	1/4	19/32	19/32
-6	3/8	51/64	25/32
-8	1/2	61/64	15/16
-12	3/4	19/64	19/64
-16	1	135/64	1 17/32
-20	1 1/4	1 13/16	1 13/16
-24	1 1/2	2 11/64	2 5/32
-32	2	2 17/32	2 33/64

# Fitting Identification

## Fitting Standards

### British Thread Types

#### BSPT (British Standard Pipe Tapered)

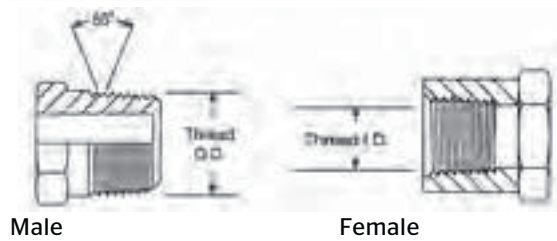

##### Identification

The British Standard Pipe Tapered is very similar to the NPTF fitting. Male fitting has a tapered thread. BSP threads are also known as Whitworth threads.

##### Seal

The BSPT male can be connected with a BSPT female or BSPP female. In either case, the seal is made within the threads through thread distortion. A thread sealant is recommended.

##### Comments

The BSPT fitting, although similar to the NPTF fitting, is not interchangeable. The thread pitch is different in most cases and the thread angle is 55 degrees for the BSPT, versus the 60 degrees found on NPTF threads.

#### BSPP (British Standard Pipe Parallel)

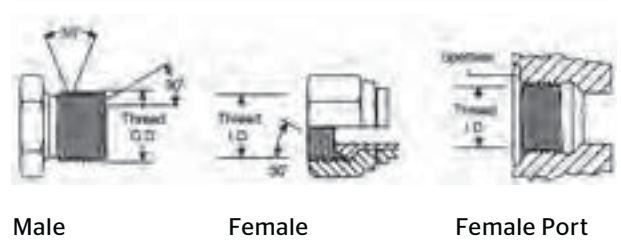

##### Identification

The British Standard Pipe Parallel would be similar to the NPSM fitting. BSP threads are also known as Whitworth threads.

##### Seal

The BSPP male will connect with the BSPP female or female port. Both male and female have a straight thread and 30-degree seat and chamfer. The seal takes place by compression of the 30-degree seat on the chamfer. The threads hold the connection mechanically.

##### Comments

The BSPP fitting, although similar to the NPSM fitting, is not interchangeable. The thread pitch is different in most cases and the thread angle is 55 degrees for the BSPP, versus the 60 degrees found on NPSM threads.

#### Thread Identification Table

BSPT and BSPP

Dash Size	Nominal Size	Thread Size	Female Thread ID	Male Thread OD
	in.		in.	in.
-2	1/8	1/8-28	11/32	3/8
-4	1/4	1/4-19	15/32	17/32
-6	3/8	3/8-19	19/32	21/32
-8	1/2	1/2-14	3/4	13/16
-10	5/8	5/8-14	13/16	29/32
-12	3/4	3/4-14	31/32	1 1/32
-16	1	1-11	1 1/32	1 11/32
-20	1 1/4	1 1/4-11	1 17/32	1 21/32
-24	1 1/2	1 1/2-11	1 25/32	1 7/8
-32	2	2-11	2 7/32	2 11/32

## Fitting Identification

### Fitting Standards

## French Thread Types

### Millimetric and GAZ 24°

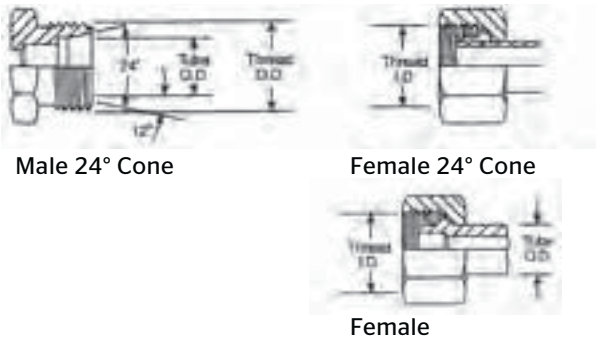

Male 24° Cone

Female 24° Cone

Female

#### Identification

GAZ fittings have a 24-degree seat and straight, metric threads. While similar to DIN fittings, the French use fine threads on all sizes while the DIN fitting may have a coarse thread on the larger sizes.

#### Seal

The French Metric (GAZ) male with 24-degree seat will mate with the female, 24-degree cone or the female tube fitting.

#### Comments

The Millimetric Series is used with whole number metric OD tubing and the GAZ Series is used with fractional number metric OD pipe size tubing.

#### Thread Identification Table

French Metric Millimetric

Metric Thread	Female Thread ID		Male Thread OD		Tube OD	
Dia. x Pitch	mm.	in.	mm	in.	mm	in.
M 12 x 1	11.0	0.43	12.0	0.47	6	0.24
M 14 x 1½	12.5	0.49	14.0	0.55	8	0.31
M 16 x 1½	14.5	0.57	16.0	0.63	10	0.39
M 18 x 1½	16.5	0.65	18.0	0.71	12	0.47
M 20 x 1½	18.5	0.73	20.0	0.79	14	0.55
M 22 x 1½	20.5	0.81	22.0	0.87	15	0.59
M 24 x 1½	22.5	0.89	24.0	0.94	16	0.63
M 27 x 1½	25.5	1.00	27.0	1.06	18	0.71
M 30 x 1½	28.5	1.12	30.0	1.18	22	0.87
M 33 x 1½	31.5	1.24	33.0	1.30	25	0.98
M 36 x 1½	34.5	1.36	36.0	1.42	28	1.10
M 39 x 1½	37.5	1.48	39.0	1.54	30	1.18
M 42 x 1½	40.5	1.59	42.0	1.65	32	1.26
M 45 x 1½	43.5	1.71	45.0	1.77	35	1.38
M 48 x 1½	46.5	1.83	48.0	1.89	38	1.50
M 52 x 1½	50.5	1.99	52.0	2.05	40	1.57
M 54 x 2	51.9	2.04	54.0	2.13	45	1.77

#### Thread Identification Table

French Metric GAZ 24° Cone

Dash Size	Metric Thread	Female Thread ID		Male Thread OD		Tube OD	
Dash	Dia. x Pitch	mm	in.	mm	in.	mm	in.
-6	M 20 X 1.5	18.5	0.73	20.0	0.78	13.25	0.52
-8	M 24 X 1.5	22.5	0.89	24.0	0.94	16.75	0.66
-10	M 30 X 1.5	28.5	1.12	30.0	1.18	21.25	0.83
-12	M 36 X 1.5	34.5	1.36	36.0	1.41	26.75	1.05
-16	M 45 X 1.5	43.5	1.71	45.0	1.77	33.50	1.32
-20	M 52 X 1.5	50.5	1.99	52.0	2.04	42.25	1.66

## GAZ Poclairn 24° Flange

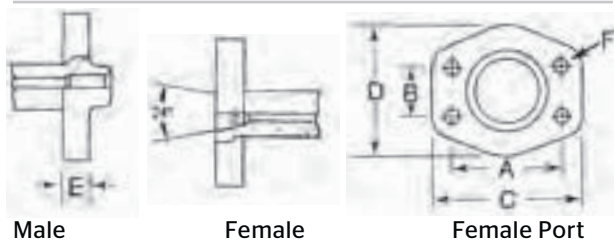

Male

Female

Female Port

#### Identification

Usually found on Poclairn equipment. The Poclairn flange with a 24-degree seat is different from an SAE flange in that there is a lip that protrudes from the flange face.

#### Seal

The male flange will connect with a female flange or port. The seal is made on the 24-degree seat.

#### Thread Identification Table

GAZ Poclairn 24° Flange

Nominal Size	A	B	C	D	E	F
1/2	1.57	0.72	2.20	1.89	0.55	0.35
5/8	1.57	0.72	2.20	1.89	0.55	0.35
3/4	2.00	0.94	2.75	2.38	0.71	0.43

# Fitting Identification

## Fitting Standards

### German Thread Types

#### DIN 2353 24° Cone

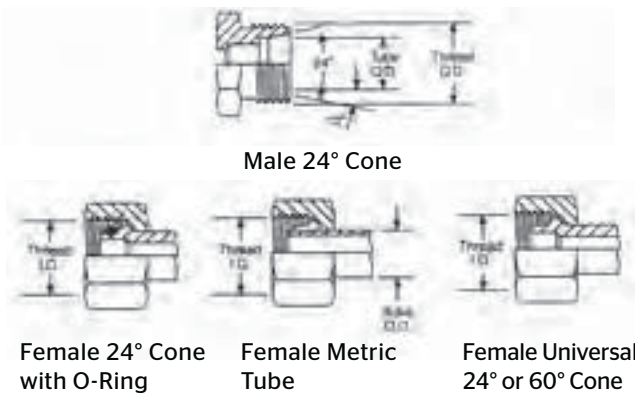

#### Identification

Both male and female have straight metric threads. The male has a 24-degree seat and a recessed counter bore which matches the tube OD used with it. The female can be any of three styles including a 24-degree cone with an O-ring, a metric tube fitting, or a universal 24- or 60-degree cone. Use a 12-degree gauge to measure seat angle as the dimension is taken from the fitting centerline.

#### Seal

Sealing takes place between the 24-degree seat in the male end and the respective sealing area in the female end.

#### Comments

There is a light and heavy version of this coupling. Proper identification is made by measuring the thread size and tube OD. The heavy-duty version has a smaller tube OD than the light-duty version, but has a thicker wall section.

#### Thread Identification Table

DIN 2353 24° Cone

Metric Thread	Female Thread ID		Male Thread OD		Tube OD Light Series		Tube OD Heavy Series	
	mm	in.	mm	in.	mm	in.	mm	in.
M 12 x 1½	10.5	0.41	12	0.47	6	0.24		
M 14 x 1½	12.5	0.49	14	0.55	8	0.31	6	0.24
M 16 x 1½	14.5	0.57	16	0.63	10	0.39	8	0.31
M 18 x 1½	16.5	0.65	18	0.71	12	0.47	10	0.39
M 20 x 1½	18.5	0.73	20	0.79			12	0.47
M 22 x 1½	20.5	0.81	22	0.87	15	0.59	14	0.55
M 24 x 1½	22.5	0.89	24	0.94			16	0.63
M 26 x 1½	24.5	0.96	26	1.02	18	0.71		

DIN 2353 24° Cone (Continued on next column)

DIN 2353 24° Cone (Continued)

Metric Thread	Female Thread ID		Male Thread OD		Tube OD Light Series		Tube OD Heavy Series	
	mm	in.	mm	in.	mm	in.	mm	in.
M 30 x 2	28.5	1.12	30	1.18	22	0.87	20	0.79
M 36 x 2	33.9	1.33	36	1.42	28	1.10	25	0.98
M 42 x 2	39.9	1.57	42	1.65			30	1.18
M 45 x 2	42.9	1.69	45	1.77	35	1.38		
M 52 x 2	49.9	1.96	52	2.05	42	1.65	38	1.50

#### DIN 3863 60° Cone

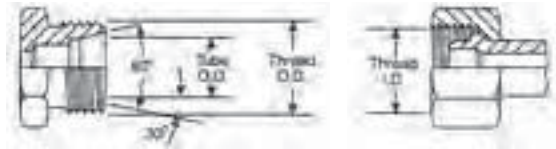

Male 60° Cone

Female 24° or 60° Cone

#### Identification

Both male and female have straight metric threads. Use a 30-degree gauge to measure seat angle as this dimension is taken from the fitting centerline.

#### Seal

The male has a 60-degree seat. The female has a 24- or 60-degree seat. The seal takes place by contact between the 60-degree seat in the male end and the respective sealing area in the female end.

#### Thread Identification Table

DIN 3863 60° Cone

Metric Thread	Female Thread ID		Male Thread OD		Tube OD 60° Cone	
	in.	mm	in.	mm	in.	mm
M 12 x 1½	10.5	0.41	12	0.47	6	0.24
M 14 x 1½	12.5	0.49	14	0.55	8	0.31
M 16 x 1½	14.5	0.57	16	0.63	10	0.39
M 18 x 1½	16.5	0.65	18	0.71	12	0.47
M 22 x 1½	20.5	0.81	22	0.87	15	0.59
M 26 x 1½	24.5	0.96	26	1.02	18	0.71
M 30 x 2	28.5	1.12	30	1.18	22	0.87
M 38 x 2	36.5	1.44	38	1.50	28	1.10
M 45 x 2	43.5	1.71	45	1.77	35	1.38
M 52 x 2	50.5	1.99	52	2.05	42	1.65

# Fitting Identification

## Fitting Standards

### DIN 3852 Types A & B

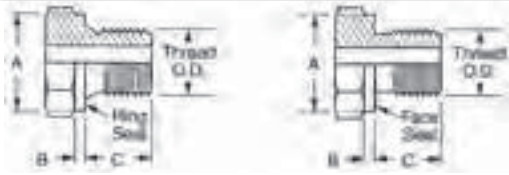

Male Type A

Male Type B

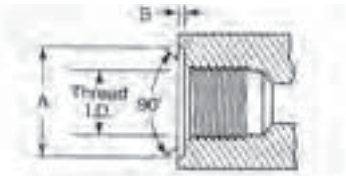

Female Types A & B

#### Identification

Both male and female, type A (light duty) and type B (heavy duty) have straight threads.

#### Seal

The seal occurs when the ring seal in type A or the face seal in type B connects with the face of the female port.

#### Thread Identification Tables

DIN 3852 Types A & B

##### Male Metric Thread Parallel

	Tube OD	Metric Thread Size	Thread OD	A	B	C
	mm	mm	mm	mm	mm	mm
L Light	6	10 x 1	10	14	1.5	8
	8	12 x 1½	12	17	2.0	12
	10	14 x 1½	14	19	2.0	12
	12	16 x 1½	16	21	2.5	12
	15	18 x 1½	18	23	2.5	12
	18	22 x 1½	22	27	3.0	14
	22	26 x 1½	26	31	3.0	16
	28	33 x 2	33	39	3.0	18
S Heavy	35	42 x 2	42	49	3.0	20
	42	48 x 2	48	55	3.0	22
	6	12 x 1½	12	17	2.0	12
	8	14 x 1½	14	19	2.0	12
	10	16 x 1½	16	21	2.5	12
	12	18 x 1½	18	23	2.5	12
	14	20 x 1½	20	35	3.0	14
	16	22 x 1½	22	27	3.0	14
	20	27 x 2	27	32	3.0	16
	25	33 x 2	33	39	3.0	18
30	42 x 2	42	49	3.0	20	
38	48 x 2	48	55	3.0	22	

DIN 3852 Types A & B (Continued on next column)

### DIN 3852 Types A & B (Continued)

##### Female Metric Thread Parallel

	Tube OD	Metric Thread Size	Thread ID	A	B
	mm	mm	mm	mm	mm
L Light	6	10 x 1	8.5	15	1.0
	8	12 x 1½	10.5	18	1.5
	10	14 x 1½	12.5	20	1.5
	12	16 x 1½	14.5	22	1.5
	15	18 x 1½	16.5	24	2.0
	18	22 x 1½	20.5	28	2.5
	22	26 x 1½	24.5	32	2.5
	28	33 x 2	31.5	40	2.5
	35	42 x 2	40.5	50	2.5
	42	48 x 2	46.5	56	2.5
S Heavy	6	12 x 1½	10.5	18	1.5
	8	14 x 1½	12.5	20	1.5
	10	16 x 1½	14.5	22	1.5
	12	18 x 1½	16.5	24	2.0
	14	20 x 1½	18.5	26	2.0
	16	22 x 1½	20.5	28	2.5
	20	27 x 2	25.5	33	2.5
	25	33 x 2	31.5	40	2.5
	30	42 x 2	40.5	50	2.5
	38	48 x 2	46.5	56	2.5

##### Male Whitworth Thread Parallel (BSPP)

	Tube OD	Metric Thread Size	Thread OD	A	B	C	
	mm	mm	in.	mm	mm	mm	
L Light	6	1/8-28	3/8	14	1.5	8	
	8	1/4-19	1/2	17	2.0	12	
	10	1/4-19	1/2	19	2.0	12	
	12	3/8-19	21/32	21	2.5	12	
	15	1/2-14	13/16	23	2.5	12	
	18	1/2-14	13/16	27	3.0	14	
	22	3/4-14	11/32	31	3.0	16	
	28	1-11	15/16	39	3.0	18	
	35	1¼-11	121/32	49	3.0	20	
	42	1½-11	17/8	55	3.0	22	
	S Heavy	6	1/4-19	1/2	17	2.0	12
		8	1/4-19	1/2	19	2.0	12
10		3/8-19	21/32	21	2.5	12	
12		3/8-19	21/32	23	2.5	12	
14		1/2-14	13/16	25	3.0	14	
16		1/2-14	13/16	27	3.0	14	
20		3/4-14	11/32	32	3.0	16	
25		1-11	15/16	39	3.0	18	
30		1¼-11	121/32	49	3.0	20	
38		1½-11	17/8	55	3.0	22	

DIN 3852 Types A & B (Continued on next page)



# Fitting Identification

## Fitting Standards

DIN 3852 Types A & B (Continued)

Female Whitworth Thread Parallel (BSPOR)					
	Tube OD	Metric Thread Size	Thread ID	A	B
	mm	mm	in.	mm	mm
L Light	6	1/8-28	11/32	15	1.0
	8	1/4-19	15/32	19	1.5
	10	1/4-19	15/32	19	1.5
	12	3/8-19	19/32	23	2.0
	15	1/2-14	3/4	27	2.5
	18	1/2-14	3/4	27	2.5
	22	3/4-14	31/32	33	2.5
	28	1-11	1 1/32	40	2.5
	35	1 1/4-11	1 1/32	50	2.5
	42	1 1/2-11	1 25/32	56	2.5
S Heavy	6	1/4-19	15/32	19	1.5
	8	1/4-19	15/32	19	1.5
	10	3/8-19	19/32	23	2.0
	12	3/8-19	19/32	23	2.0
	14	1/2-14	3/4	27	2.5
	16	1/2-14	3/4	27	2.5
	20	3/4-14	31/32	33	2.5
	25	1-11	1 1/32	40	2.5
	30	1 1/4-11	1 1/32	50	2.5
	38	1 1/2-11	1 25/32	56	2.5

### DIN 3852 Type C

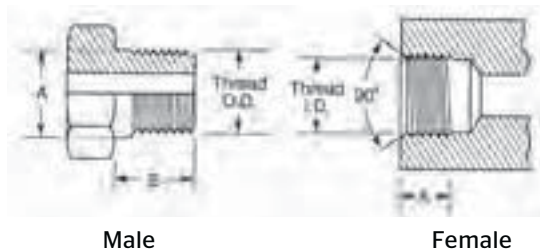

#### Identification

Both male and female have tapered threads, and are available in metric and Whitworth threads.

#### Seal

The male will only connect with the female as shown. The seal takes place on the threads.

#### Comments

Type C couplings are available in extra light (LL), light (L) and heavy (S).

### Thread Identification Table

DIN 3852 Type C

Male Metric Tapered Threads					
	Tube OD	Metric Thread Size	A	B	Thread OD
	mm	mm	mm	mm	mm
LL Extra Light	4	8 x 1	8.40	8	8
	5	8 x 1	8.40	8	8
	6	10 x 1	10.40	8	10
L Light	8	10 x 1	10.40	8	10
	6	10 x 1	10.40	8	10
	8	12 x 1 1/2	12.53	12	12
	10	14 x 1 1/2	14.53	12	14
	12	16 x 1 1/2	16.53	12	16
	15	18 x 1 1/2	18.53	12	18
S Heavy	18	22 x 1 1/2	22.65	14	22
	6	12 x 1 1/2	12.53	12	12
	8	14 x 1 1/2	14.53	12	14
	10	16 x 1 1/2	16.53	12	16
	12	18 x 1 1/2	18.53	12	18
	14	20 x 1 1/2	20.65	14	20

Female Metric Tapered Threads				
	Tube OD	Metric Thread Size	Thread ID	A
	mm	mm	mm	mm
LL Extra Light	4	8 x 1	6.5	5.5
	5	8 x 1	6.5	5.5
	6	10 x 1	8.5	5.5
L Light	8	10 x 1	8.5	5.5
	6	10 x 1	8.5	5.5
	8	12 x 1 1/2	10.5	8.5
	10	14 x 1 1/2	12.5	8.5
	12	16 x 1 1/2	14.5	8.5
	15	18 x 1 1/2	16.5	8.5
S Heavy	18	22 x 1 1/2	20.5	10.5
	6	12 x 1 1/2	10.5	8.5
	8	14 x 1 1/2	12.5	8.5
	10	16 x 1 1/2	14.5	8.5
	12	18 x 1 1/2	16.5	8.5
	14	20 x 1 1/2	18.5	10.5

DIN 3852 Type C (Continued on next page)

# Fitting Identification

## Fitting Standards

### DIN 3852 Type C (Continued)

#### Male Whitworth Tapered Threads

	Tube OD	Thread Size	A	B	Thread OD
	mm	in.	in.	mm	in.
LL Extra Light	4	1/8-28	0.392	8	1/8
	5	1/8-28	0.392	8	1/8
	6	1/8-28	0.392	8	1/8
	8	1/8-28	0.392	8	1/8
L Light	6	1/8-28	0.392	8	1/8
	8	1/4-19	0.532	12	1/4
	10	1/4-19	0.532	12	1/4
	12	3/8-19	0.670	12	3/8
	15	1/2-14	0.839	14	1/2
S Heavy	6	1/4-19	0.532	12	1/4
	8	1/4-19	0.532	12	1/4
	10	3/8-19	0.670	12	3/8
	12	3/8-19	0.670	12	3/8
	14	1/2-14	0.839	14	1/2
16	1/2-14	0.839	14	1/2	

#### Female Whitworth Tapered Threads

	Tube OD	Thread Size	Thread ID	A
	mm	in.	in.	mm
LL Extra Light	4	1/8-28	11/32	5.5
	5	1/8-28	11/32	5.5
	6	1/8-28	11/32	5.5
	8	1/8-28	11/32	5.5
L Light	6	1/8-28	11/32	5.5
	8	1/4-19	15/32	8.5
	10	1/4-19	15/32	8.5
	12	3/8-19	19/32	8.5
	15	1/2-14	3/4	8.5
S Heavy	6	1/4-19	15/32	8.5
	8	1/4-19	15/32	8.5
	10	3/8-19	19/32	8.5
	12	3/8-19	19/32	8.5
	14	1/2-14	3/4	10.5
16	1/2-14	3/4	10.5	

### Standpipe Assembly

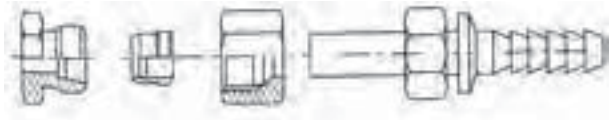

Male Bit Sleeve Nut Fitting

#### Identification

A metric standpipe is comprised of three components attached to a male fitting. The components are a standpipe, a bite sleeve and a metric nut.

#### Comments

The bite sleeve and standpipe are selected on the basis of tube OD A DIN light metric nut or heavy metric nut can also be selected.

#### Thread Identification Table

Metric Standpipe Assembly

Metric DIN Tube OD	Bite Sleeve DIN Tube OD	Metric Nut Thread	
		Light	Heavy
6	6	M 12x1½	
8	8	M 14x1½	M 16x 1½
10	10	M 16x1½	M 18x 1½
12	12	M 18x1½	M 20x 1½
15	15	M 22x1½	
16	16		M 24x 1½
18	18	M 26x 1½	
20	20		M 30x2
22	22	M 30x2	
25	25		M 36x2
28	28	M 36x2	
30	30		M 42x2
35	35	M 45x2	
38	38		M 52x2
42	42	M 52x2	

# Fitting Identification

## Fitting Standards

### DIN 20066 4-Bolt Flange

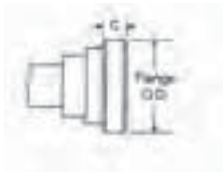

Flange Head



4-Bolt Split Flange

#### Identification

The female port is an unthreaded hole surrounded with 4 bolt holes in a rectangular pattern. The male consists of a flanged head, grooved for an O-ring, and a flange with holes to match the port.

#### Seal

The seal takes place on the O-ring, which is compressed between the flanged head and the flat surface surrounding the port. The threaded bolts hold the connection mechanically.

#### Comments

There are two pressure ratings. Form R is similar to SAE Code 61 and is referred to as the "standard" series. Form S is similar to SAE Code 62 and is referred to as the "heavy duty" series. The design concept is the same, but bolt diameters and flange head diameters are larger for the Form S fitting. Both metric and inch bolts are used. DIN 20066 is interchangeable with both SAE J518 and JIS B 8363.

### Thread Identification Table

DIN 2066 4-Bolt Flange

Nominal Flange Size	Form R			
in.	Flange OD	A	B	C
1/2	1.188	0.688	1.500	0.265
5/8	1.345			0.265
3/4	1.500	0.875	1.875	0.265
1	1.750	1.031	2.062	0.315
1¼	2.000	1.188	2.312	0.315
1½	2.375	1.406	2.750	0.315
2	2.812	1.688	3.062	0.375
2½	3.312	2.000	3.500	0.375
3	4.000	2.438	4.188	0.375
3½	4.500	2.750	4.750	0.422
4	5.000	3.062	5.125	0.442
5	6.000	3.625	6.000	0.442

Nominal Flange Size	Form S			
in.	Flange OD	A	B	C
1/2	1.250	0.718	1.594	0.305
3/4	1.625	0.937	2.000	0.345
1	1.875	1.093	2.250	0.375
1¼	2.125	1.250	2.625	0.405
1½	2.500	1.437	3.125	0.495
2	3.125	1.750	3.812	0.495

## Fitting Identification

### Fitting Standards

## Japanese Thread Types

### JIS 30° (Parallel Pipe Threads)



Male

Female

#### Identification

The male and female have straight threads and a 30-degree seat.

#### Seal

The JIS 30-degree male will only connect with the JIS 30-degree female. The seal is made on the 30-degree seat. The threads hold the connection in place mechanically.

#### Comments

The JIC 37-degree flare is very similar to the JIS 30-degree flare. To determine the difference, carefully measure the seat angle. The threads on the JIS 30 conform to JIS B 0202. While the BSPP fitting has similar threads, and also has a 30-degree seat, the JIS 30 is not interchangeable with the BSPP fitting as the British seat is inverted.

#### Thread Identification Table

JIS 30° Flare Parallel

Dash Size	Nominal Size	Thread Size	Male Thread OD	Female Thread ID
in.				
-2	1/8	1/8-28	3/8	11/32
-4	1/4	1/4-19	17/32	7/16
-6	3/8	3/8-19	21/32	19/32
-8	1/2	1/2-14	13/16	3/4
-10	5/8	5/8-14	29/32	13/16
-12	3/4	3/4-14	1 1/32	15/16
-16	1	1-11	1 5/16	1 3/16
-20	1 1/4	1 1/4-11	1 21/32	1 17/32
-24	1 1/2	1 1/2-11	1 7/8	1 25/32
-32	2	2-11	2 11/32	2 7/32

### JIS 30° Male Inverted Seat

#### (Parallel Pipe Threads) (JIS B 0202)



Male

Female

#### Identification

The JIS 30 Parallel has straight threads, conforming to JIS B 0202.

#### Seal

Both male and female have a straight thread and 30-degree seat and chamfer. The seal takes place by compression of the 30-degree seat on the chamfer. The threads hold the connection mechanically.

#### Comments

The BSPP fitting is fully interchangeable with the JIS 30, male inverted seat.

#### Thread Identification Table

JIS 30° Male Inverted Seat

Dash Size	Nominal Size	Thread Size	Male Thread OD	Female Thread ID
in.				
-4	1/4	1/4-19	8/16	15/32
-6	3/8	3/8-19	21/32	19/32
-8	1/2	1/2-14	13/16	3/4
-12	3/4	3/4-14	1 1/32	31/32
-16	1	1-11	1 5/16	1 7/32
-20	1 1/4	1 1/4-11	1 21/32	1 9/16
-24	1 1/2	1 1/2-11	1 7/8	1 25/32
-32	2	2-11	2 11/32	2 1/4

# Fitting Identification

## Fitting Standards

### JIS Tapered Pipe (JIS B 0203)

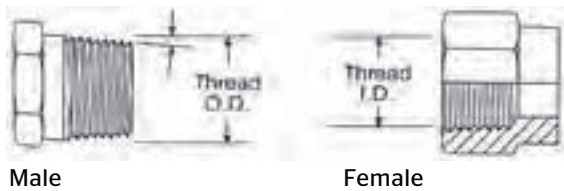

#### Identification

Both male and female have tapered threads that conform to JIS B 0203.

#### Seal

The seal is made within the threads through thread distortion. A thread sealant is recommended.

#### Comments

The JIS tapered pipe thread is similar to a BSPT fitting and is fully interchangeable.

#### Thread Identification Table

JIS Tapered Pipe

Dash Size	Nominal Size	Thread Size	Male Thread OD	Female Thread ID
	in.		in.	in.
-2	1/8	1/8-28	3/8	11/32
-4	1/4	1/4-19	17/32	7/16
-6	3/8	3/8-19	21/32	19/32
-8	1/2	1/2-14	13/16	3/4
-12	3/4	3/4-14	1 1/32	15/16
-16	1	1-11	1 5/16	1 3/16
-20	1 1/4	1 1/4-11	1 21/32	1 17/32
-24	1 1/2	1 1/2-11	1 7/8	1 25/32
-32	2	2-11	2 11/32	2 7/32

### Japanese Komatsu® 30° Flare with Metric Threads (JIS B 0207)

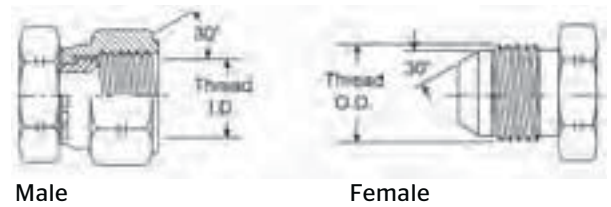

#### Identification

Same as JIS B 0202, but conforms to JIS B 0207 with metric threads.

#### Seal

Both male and female have a straight thread and 30-degree seat and chamfer. The seal takes place by compression of the 30-degree seat on the chamfer. The threads hold the connection mechanically.

#### Comments

Also known as the Komatsu® style, it is used extensively on Komatsu® equipment.

#### Thread Identification Table

Komatsu® Style 30° Flare

Dash Size	Nominal Size		Metric Thread Size	Male Thread OD	Female Thread ID
	in.	mm			
-6	3/8	9.5	M 18 x 1 1/2	18	16.5
-8	1/2	13	M 22 x 1 1/2	22	20.5
-10	5/8	16	M 24 x 1 1/2	24	22.5
-12	3/4	19	M 30 x 1 1/2	30	28.5
-16	1	25	M 33 x 1 1/2	33	31.5
-20	1 1/4	32	M 36 x 1 1/2	36	34.5
-24	1 1/2	38	M 42 x 1.5	42	40.5

# Fitting Identification

## Fitting Standards

### Komatsu® Flange Fitting

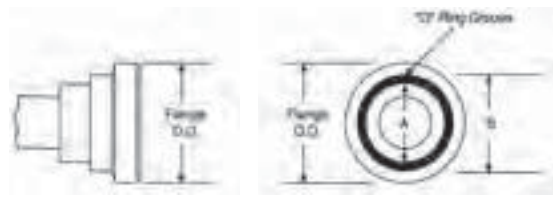

Flange

Flange Head

#### Identification

The Komatsu® Flange fitting is nearly identical to the SAE Code 61 flange fitting and fully interchangeable. As O-ring sizes are different, an SAE O-ring must be used when replacing the Komatsu® fitting with an SAE fitting.

#### Thread Identification Table

Komatsu®-Style Flange

Dash Size	Nominal Size		Flange OD	A	B
	in.	mm			
-8	1/2	12.7	1.188	0.728	0.984
-10	5/8	15.9	1.345	0.728	1.102
-12	3/4	19.1	1.500	0.846	1.220
-16	1	25.4	1.750	1.122	1.496
-20	1¼	31.8	2.000	1.358	1.732
-24	1½	38.1	2.375	1.750	2.125
-32	2	50.8	2.812	2.225	2.559

### JIS B 8363 4 Bolt Flange

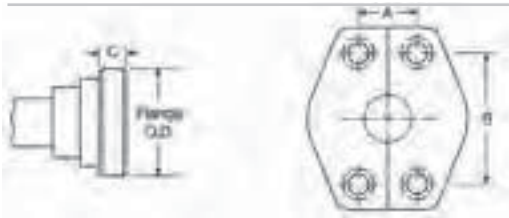

Male

Female

#### Identification

The female port is an unthreaded hole surrounded with 4 bolt holes in a rectangular pattern. The male consists of a flanged head, grooved for an O-ring, and a flange with holes to match the port.

#### Seal

The seal takes place on the O-ring, which is compressed between the flanged head and the flat surface surrounding the port. The threaded bolts hold the connection mechanically.

#### Comments

There are two pressure ratings. Type I is similar to SAE Code 61 and is referred to as the "standard" series. Type II is similar to SAE Code 62 and is referred to as the "heavy duty" series. The design concept is the same, but bolt diameters and flange head diameters are larger for the Type II fitting. Both metric and inch bolts are used. JIS B 8363 is interchangeable with both SAE J518 and DIN 20066.

#### Thread Identification Table

JIS B 8363 4-Bolt Flange

Nominal Flange Size	Type I			
	Flange OD	A	B	C
1/2	1.188	0.688	1.500	0.265
5/8	1.345			0.265
3/4	1.500	0.875	1.875	0.265
1	1.750	1.031	2.062	0.315
1¼	2.000	1.188	2.312	0.315
1½	2.375	1.406	2.750	0.315
2	2.812	1.688	3.062	0.375
2½	3.312	2.000	3.500	0.375
3	4.000	2.438	4.188	0.375
3½	4.500	2.750	4.750	0.422
4	5.000	3.062	5.125	0.442
5	6.000	3.625	6.000	0.442

Nominal Flange Size	Type II			
	Flange OD	A	B	C
1/2	1.250	0.718	1.594	0.305
3/4	1.625	0.937	2.000	0.345
1	1.875	1.093	2.250	0.375
1¼	2.125	1.250	2.625	0.405
1½	2.500	1.437	3.125	0.495
2	3.125	1.750	3.812	0.495

# Fitting Identification Templates

## Male Pipe Thread Sizes

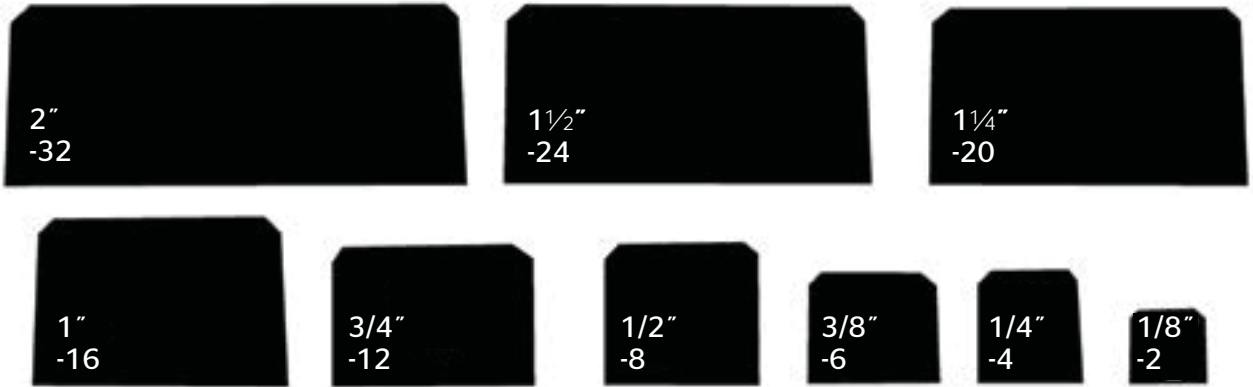

## JIC 37° Flare (SAE J514) Thread Sizes

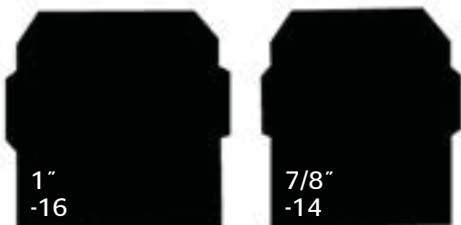
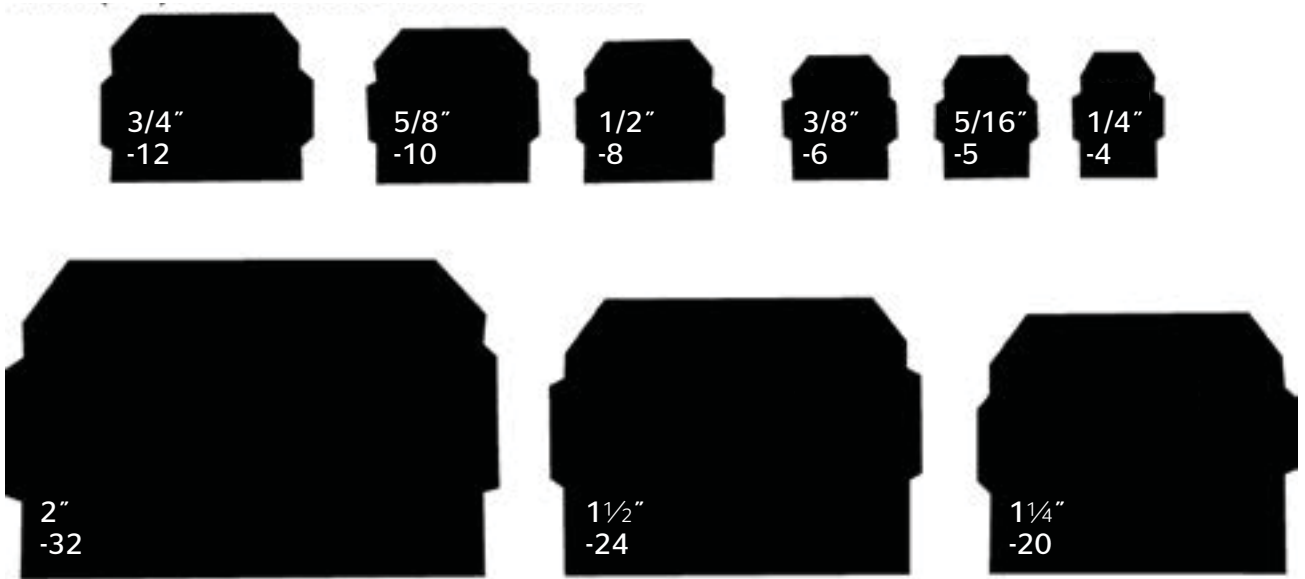

37° and 45° Flare  
Nose Angles



SAE 45° Flare  
(SAE J512) Thread Sizes



## Fitting Identification

### Templates (Continued)

#### O-Ring Face Seal (SAE J1453 ORS/ORFS)

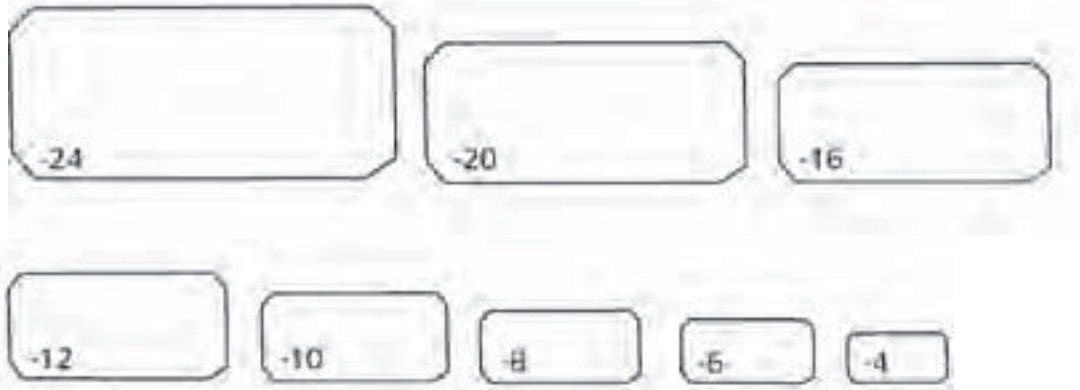

#### Fitting Nuts

Continental ContiTech fittings can have three types of nuts: Crimp Nut, Thrust-Wire Nut, and Slip-On Nut. Shown below are sample images with the three types of nuts.

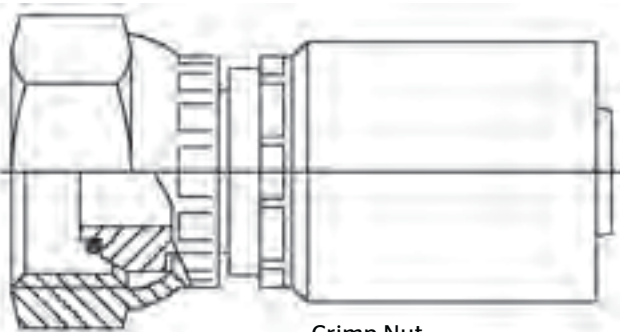

Crimp Nut

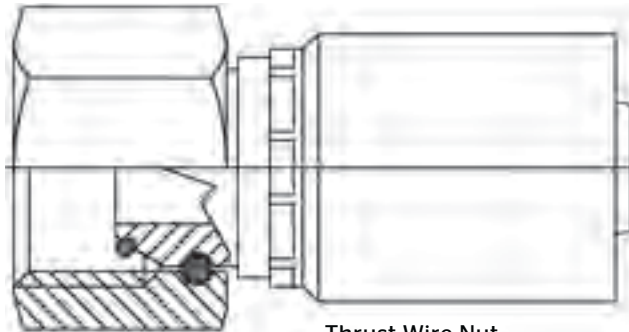

Thrust-Wire Nut

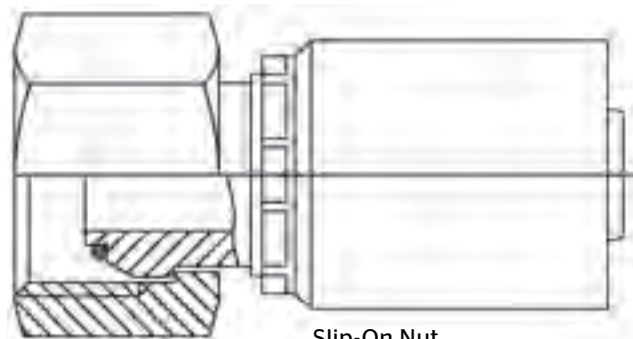

Slip-On Nut



# Torque Values

	Dash Size	Thread Size	Swivel Nut Torque	
		in.	ft./lbs.	N/m
O-Ring	-4	9/16-18	10-12	14-16
Face Seal	-6	11/16-16	18-20	24-27
(SAE J1453)	-8	13/16-16	32-35	43-47
	-10	1-14	46-50	62-68
	-12	1 3/16-12	65-70	88-95
	-16	1 7/16-12	92-100	125-136
	-20	1 11/16-12	125-140	170-190
	-24	2-12	150-165	204-224

	Dash Size	Thread Size	Jam Nut or Straight Fitting Torque	
		in.	ft./lbs.	N/m
O-Ring	-3	3/8-24	8-9	12-13
Boss Straight	-4	7/16-20	13-15	18-20
Thread	-5	1/2-20	14-15	19-21
(SAE J514)	-6	9/16-18	23-24	32-33
	-8	3/4-16	40-43	55-57
	-10	7/8-14	43-48	59-64
	-12	1 1/16-12	68-75	93-101
	-14	1 3/16-12	83-90	113-122
	-16	1 5/16-12	112-123	152-166
	-20	1 5/8-12	146-161	198-218
	-24	1 7/8-12	154-170	209-230
	-32	2 1/2-12	218-240	296-325

	Dash Size	Thread Size	Swivel Nut Torque	
		in.	ft./lbs.	N/m
JIC 37° Flare	-4	7/16-20	11-12	15-16
(SAE J514)	-5	1/2-20	15-16	20-22
	-6	9/16-18	18-20	24-28
	-8	3/4-16	38-42	52-58
	-10	7/8-14	57-62	77-85
	-12	1 1/16-12	79-87	108-119
	-14	1 3/16-12	94-103	127-140
	-16	1 5/16-12	108-113	148-154
	-20	1 5/8-12	127-133	173-182
	-24	1 7/8-12	158-167	216-227
	-32	2 1/2-12	245-258	334-352

	Dash Size	Port Hole ID		
		in.	ft./lbs.	N/m
Code 61	-8	1/2	15-19	20-25
Flange Bolt (SAE J518)	-12	3/4	21-29	28-40
	-16	1	27-35	37-48
	-20	1 1/4	35-46	48-62
	-24	1 1/2	46-58	62-79
	-32	2	54-66	73-90
	-40	2 1/2	79-91	107-124
	-48	3	137-149	186-203

	Dash Size	Port Hole ID		
		in.	ft./lbs.	N/m
Code 62	-8	1/2	15-19	20-25
Flange Bolt (SAE J518)	-12	3/4	25-33	34-45
	-16	1	42-50	56-68
	-20	1 1/4	62-75	85-102
	-24	1 1/2	116-133	158-181
	-32	2	199-216	271-294

	Dash Size	Nominal Thread Size	Swivel Nut Torque	
		in.	ft./lbs.	N/m
JIS 30° (B83632000)	-4	1/4-19	19	25
	-6	3/8-19	25	34
	-8	1/2-14	49	64
	-10	5/8-14	100	132
	-12	3/4-14	100	132
	-16	1-11	149	196
	-20	1 1/4-11	171	225
	-24	1 1/2-11	194	255
	-32	2-11	240	316

	Thread Size	Swivel Nut Torque	
	mm	ft./lbs.	N/m
Metric	M 10 x 1	13-15	18-20
	M 12 x 1.5	15-19	20-25
	M 14 x 1.5	19-23	25-30
	M 16 x 1.5	33-40	45-55
	M 18 x 1.5	37-44	50-60
	M 20 x 1.5	52-66	70-90
	M 22 x 1.5	55-70	75-95
	M 26 x 1.5	81-96	110-130
	M 27 x 2	96-111	130-150
	M 33 x 2	162-184	220-250
	M 42 x 2	170-192	230-260
	M 48 x 2	258-347	350-470

## Torque Values

	Dash Size		
	mm	ft./lbs.	N/m
Maximum	-2	20	25
Recommended	-4	25	35
Torque for Dry	-6	35	45
NPTF (Tapered)	-8	45	60
Pipe Threads	-12	55	75
	-16	65	90
	-20	80	110
	-24	95	130
	-32	120	160

	Dash Size	Nominal Thread Size	With O-Ring		Without O-Ring	
			ft./lbs.	N/m	ft./lbs.	N/m
		<b>in.</b>				
BSPP	-2	G 1/8-28	NA	NA	7	10
**G* denotes	-4	G 1/4-19	15	20	15	20
parallel	-6	G 3/8-19	26	35	26	35
threads	-8	G 1/2-14	37	50	44	60
	-10	G 5/8-14	44	60	52	70
	-12	G 3/4-14	63	85	85	115
	-16	G 1-11	85	115	103	140
	-20	G 1 1/4-11	140	190	155	210
	-24	G 1 1/2-11	177	240	214	290
	-32	G 2-11	221	300	295	400

### \*\*Notes:

1. The torque values obtained from tightening pipe threads can vary considerably depending on thread condition. Adequate sealing can occur at values much lower than the maximum values listed above. Only enough torque to achieve adequate sealing should be used.
2. When using a male tapered pipe thread with a female straight or parallel pipe thread, maximum values are 50% of those listed in the table.
3. If thread sealant is used, maximum values shown should be decreased by 25%.

# Hose ID Selection Nomograph

The chart below is intended to aid in the selection of the correct hose size. By choosing a flow rate and a flow velocity, the optimum hose ID can be determined. Selecting the correct hose ID is important to prevent an oversized assembly, which can be heavy and costly or an undersized assembly causing an excessive pressure drop.

**Example:** To find the correct hose ID for a system running at 13 gallons/minute and 10 feet/second, draw a line between the two values on each grid. The intersection of that line on the ID grid is 3/4" ID

Recommendations are based on a oil viscosity of 315 S.S.U., at 100°F, operating at a temperature of 65°F to 155°F.

## Selecting the Correct Hose ID

1. Choose flow rate and flow velocity. Locate each value on its grid.
2. Lay a straightedge to connect the two values.
3. The recommended hose ID is located on the ID scale, at the intersection of the line drawn between flow rate and flow velocity. Should the line intersect between two values, use the next highest ID.

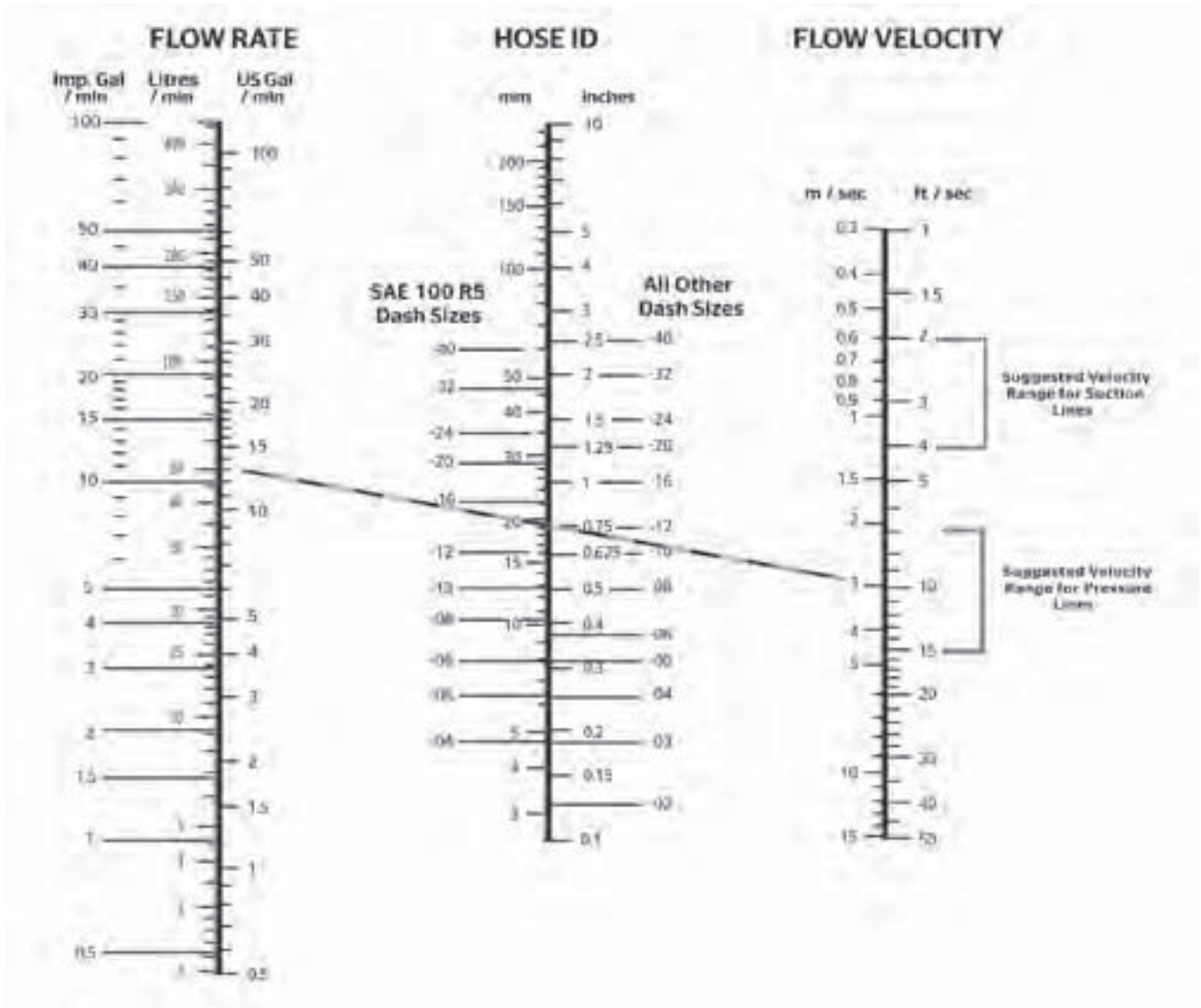

## Hose ID Selection Nomograph

The following table represents the maximum flow rate in gallons per minute (GPM) by hose ID for pressure lines and suction lines. The recommended maximum fluid velocity for pressure systems is 15 feet per second (FPS).

Hose ID	Recommended Maximum Flow (GPM) Pressure Lines	Recommended Maximum Flow (GPM) Suction Lines
	in.	
3/16	1.29	0.35
1/4	2.30	0.61
5/16	3.59	0.96
3/8	5.16	1.38
13/32	6.06	16.20
1/2	9.18	2.45
5/8	14.35	3.83
3/4	20.66	5.51
7/8	28.12	7.50
1	36.72	9.79
1 1/8	46.48	12.39
1 1/4	57.38	15.30
1 3/8	69.43	18.51
1 1/2	82.63	22.03
1 13/16	120.64	32.17
2	146.89	39.17

Use the following formulas for Velocity, Gallons per Minute, or Hose ID

$$V = \text{Velocity in Feet per Second (FPS)} = (.408 \times \text{GPM})/D^2$$

$$\text{GPM} = \text{Flow rate in Gallons per Minute (GPM)} = V \times D^2 / .408$$

$$D = \text{Hose ID (inches)} = \sqrt{\frac{.408 \times \text{GPM}}{V}}$$

The recommended maximum velocity for hydraulic systems is 15 FPS. For higher velocity, contact Continental ContiTech Technical Support with specific system information.

$$\text{Imperial Gallon} = \text{U.S. Gallon} \times 0.83267$$

$$\text{U.S. Gallon} = \text{Imperial Gallon} \times 1.20095$$

$$\text{Liter} = \text{U.S. Gallon} \times 3.785$$

$$\text{U.S. Gallon} = \text{Liter} \times .2642$$

# Hose Pressure Drop

Pressure drop is defined as the difference in input pressure and output pressure of a hose assembly. There are many factors which can contribute to pressure drop including the length of the hose assembly, the type and temperature of the fluid, flow rate, the

inside diameter of the hose, and the type of couplings used.

If pressure drop is a concern, this chart can be used for a quick estimate for a hose assembly that is 10 feet long with a fluid specification of .85 specific

gravity, a viscosity of 20 centistokes (97 S.S.U.), and a temperature of 100°F (38°C). Differences in fluids, fluid temperature, and viscosity can increase or decrease actual pressure drop compared to the values listed.

## Pressure Drop (psi)

	Dash Size	-3	-4	-5	-6	-8	-10	-12	-16	-20	-24	-32	-40	-48
	Hose ID	3/16	1/4	5/16	3/8	1/2	5/8	3/4	1	1¼	1½	2	2½	3
	<b>in.</b>													
U.S.	0.25	10	3.1											
	0.50	19	6	2.7										
gpm	1	40	12	5.5	2.4									
	2	95	24	10	4.8									
	3	185	46	17	7	2.2								
	4		78	29	12	3	1.2							
	5		120	44	18	4.5	1.6	0.7						
	8			95	39	10	3.6	1.4						
	10				59	15	5.7	2	0.6					
	12				80	20	7.2	2.6	0.8					
	15					30	10	4.2	1.2	0.4				
	18					40	15	6.3	1.5	0.6				
	20					49	19	8	2	0.7	0.3			
	25					72	26	11	3	1	0.4			
	30						34	14	3.6	1.3	0.5	0.1		
	35						47	19	5	1.7	0.7	0.2		
	40							25	6.5	2.2	0.9	0.2		
	50							36	9	3.3	1.3	0.4	0.2	
	60							50	12	4.4	1.8	0.5	0.2	
	70								17	6	2.4	0.7	0.3	
	80								21	7.1	3	0.8	0.3	0.1
	90								27	9	3.8	1	0.5	0.1
	100								33	12	4.7	1.3	0.6	0.2
	150								60	22	8.5	2.2	1	0.3
	200									36	15	3.9	1.7	0.6
	250									54	22	5.3	2.5	0.8
	300										29	7.5	4	1.1
	400										51	14	6.5	2.2
	500											20	10	3
	800												18	5
	1000													10

## Chemical Resistance Tables

The following chemical resistance tables indicate the suitability of various elastomers and metals for use with fluids being conveyed. The ratings given are intended as a guide only and not a guarantee. Ratings are for tube compound only, unless otherwise stated. The final selection of the proper hose and fitting to use is further dependent on many factors including temperature, concentration, and length of exposure.

Hose ratings are for the effect on the polymer only. The degree of resistance of a rubber compound to a specific fluid depends on the variables of temperature, concentration, and length of exposure. When in doubt or when conditions vary, contact Continental ContiTech for assistance before using a specific product.

### Ratings and Definitions

- E** › The fluid is expected to have a minor or no effect on the hose and compound. Product may be used in continuous service. Changes in the substance, such as concentration or temperature, may affect hose product performance and cause degradation of the product.
- G** › The hose and compound may be used for continuous or intermittent service, however the product properties will be affected by the exposure of the chemical. Changes in the substance, such as concentration or temperature, may affect hose product performance and cause degradation of the product.
- X** › The hose and compound should not be used with this fluid.
- › Insufficient or no data is available for this fluid. Further testing is recommended to determine compatibility of the fluid with the hose and the compound.
- Blank** › No data is available.

Warning: Compatibility of hose fittings with the fluid is an essential factor in avoiding chemical reactions that may result in loss of fluid or failure of the hose connection, with the potential of causing personal injury or property damage.

# Chemical Resistance Tables

The following is a representative list of fluids and manufacturers and a general guideline for the use and compatibility of Continental ContiTech hose and fittings.

## Rating Scale

**E** = Excellent resistance    **X** = Not recommended    **Blank** = No Data  
**G** = Good resistance    **-** = Testing recommended

Chemical Name	Hose								Fittings and Adapters				
	PTFE (Teflon®)	CR (Polychloropene)	NBR (Nitrile)	Nitrile/PVC	CPE	CSM	Urethane	Nylon	Carbon Steel	Stainless Steel 304	Stainless Steel 316	Aluminum	Brass
Absorption Oil		G	E	G	-	G	-	-	-	-	-	-	E
Acetaldehyde	E	X	X	X	-	X	E	G	E	E	E	E	E
Acetamide	E	E	G	-	-	-	X	-	-	-	-	-	-
Acetate Solvent Crude	E												
Acetate Solvent Pure	E												
Acetic Acid, 100%	E	X	X	-	-	-	-	X	X	X	G	G	X
Acetic Acid, 100% (Hot Vapors)(to 200 °F)	E	G	G	-	-	-	-	X	X	X	G	G	X
Acetic Acid, 100% Boiling		X	X	-	-	-	X	X	X	X	G	-	X
Acetic Acid, 25%		G	X	G	E	G	-	X	X	G	G	G	X
Acetic Acid, 30%	E	G	X	-	E	-	-	G	X	G	E	G	X
Acetic Acid, 50%		G	X	G	E	-	-	G	X	G	G	G	X
Acetic Acid, 50% Boiling		X	X	-	-	-	-	X	X	X	G	-	-
Acetic Acid, 5-20%		G	X	G	E	G	X	E	X	G	G	G	X
Acetic Acid, 80%		X	X	-	-	-	-	X	X	G	G	G	X
Acetic Acid, 80% Boiling		X	X	-	-	-	-	X	X	X	G	X	X
Acetic Acid, Aerated		-	-	-	-	-	-	-	X	X	X	-	X
Acetic Acid, Air Free		-	-	-	-	-	-	-	X	X	X	-	X
Acetic Acid, Anhydride	E	X	X	X	E	G	-	X	X	G	G	G	X
Acetic Acid, Crude		X	X	-	-	-	-	E	X	G	E	G	X
Acetic Acid, Glacial	E	X	X	X	E	X	X	X	X	G	G	G	-
Acetil Bromide													
Acetil Chloride													
Acetil Chromide													
Acetone (Dimethylketone)	E	X	X	X	E	X	X	E	E	E	E	E	E
Acetonitrile (Methyl Cyanide)		G	X	G	E	G	-	-	-	-	-	-	-
Acetophenone													
Acetylene	E	G	G	E	E	-	-	E	E	E	E	E	G
Acrylic Esters													
Acrylonitrile (Vinyl Cyanide)	E	X	X	X	E	X	-	-	E	E	E	G	E
Adipic Acid													
Aero Lubriplate		E	E	-	-	-	-	-	E	E	E	E	-
Aero Safe 2300		X	X	-	-	-	X	-	E	E	E	E	E
Aeroshell 17A Grease		G	E	-	-	-	X	-	E	E	E	E	-
Aeroshell 750		X	G	-	-	-	X	-	E	E	E	E	-
Aeroshell 7A Grease		G	E	-	-	-	X	-	E	E	E	E	-
Aeroshell type 1A, 1AC, 4		G	E	-	-	-	E	-	-	-	-	-	-
Air 150°F		E	E	E	E	E	E	E	E	E	E	E	E
Air 180°F		G	G	G	E	G	G	E	E	E	E	E	E

Underline is cover compound rating only. Many factors, such as temperature, concentration and length of exposure, are relevant to how chemical exposure affects the tube and cover or fitting material. The fluid manufacturers recommended maximum operating temperature should be carefully observed. Exceeding the manufacturer's recommended maximum temperature can result in fluid breakdown and cause harm or shorten life of tube and cover materials. There may be instances where the hose cover could be adversely affected by fluids which would not chemically affect the hose tube. Conversely, some fluids with an adverse affect on the tube of the hose may not have a deteriorating effect on the hose cover. It is recommended that the user test the hose/fluid compatibility to their own standards. Since no industry standards exist for chemical resistance, the Compass Chemical Resistance Guide for Elastomers is used whenever possible. Teflon® is a registered trademark of Dupont.

# Chemical Resistance Tables

The following is a representative list of fluids and manufacturers and a general guideline for the use and compatibility of Continental ContiTech hose and fittings.

## Rating Scale

E = Excellent resistance    X = Not recommended    Blank = No Data  
G = Good resistance    - = Testing recommended

Chemical Name	Hose								Fittings and Adapters				
	PTFE (Teflon®)	CR (Polychloroprene)	NBR (Nitrile)	Nitrile/ PVC	CPE	CSM	Urethane	Nylon	Carbon Steel	Stainless Steel 304	Stainless Steel 316	Aluminum	Brass
Air 200°		X	X	X	E	X	G	G	E	E	E	E	E
Air Ambient		E	E	E	E	E	E	E	E	E	E	E	E
Aircraft Hydr Oil AA		-	E	-	-	-	-	-	E	E	E	E	E
Alcohol	E	E	E	-	-	-	-	-	E	E	E	E	E
Alcohol, Amyl		G	G	-	-	-	-	E	-	G	E	G	-
Alcohol, Benzyl		X	X	-	E	G	G	-	E	E	E	-	-
Alcohol, Butyl		G	X	G	-	G	E	E	E	E	E	E	E
Alcohol, Denatured		E	E	-	-	E	-	E	E	E	E	E	E
Alcohol, Diacetone		-	X	-	-	G	-	-	E	E	E	E	E
Alcohol, Ethyl (Ethanol)		E	E	E	E	E	G	E	E	E	E	E	G
Alcohol, Furfural		G	X	X	E	G	-	-	G	E	E	E	E
Alcohol, Hexyl (Hexanol)		G	E	-	-	X	-	-	E	E	E	E	G
Alcohol, Isobutyl		G	G	-	-	E	-	E	E	E	E	E	G
Alcohol, Isopropyl (Isopropanol)		G	G	G	-	G	G	E	E	E	E	E	G
Alcohol, Methyl (100%) (Methanol)1		E	E	E	E	E	-	E	E	E	E	E	G
Alcohol, Methyl (6%)		E	E	E	-	E	-	E	E	E	E	E	G
Alcohol, Octyl		G	G	-	-	-	-	E	E	E	E	E	-
Alcohol, Propyl		E	E	-	-	-	-	X	G	E	E	E	E
Aliphatic (to 70°F)	E												
Alkazeine		X	X	X	-	X	X	-	E	E	-	-	-
Alkyd Resins													
Aluminum Chloride	E	E	E	E	E	E	G	X	X	G	G	X	X
Aluminum Fluoride, 20%+A21	E	E	E	E	E	E	G	X	X	G	G	G	X
Aluminum Hydroxide	E	E	E	E	E	E	-	E	-	E	E	-	E
Aluminum Hydroxide, Saturated		E	E	-	-	-	-	E	-	E	E	-	-
Aluminum Nitrate	E	E	E	E	E	E	G	-	X	E	E	G	-
Aluminum Sulfate	E	E	E	E	E	E	X	E	X	X	G	X	X
Alums (Ammonium or Potassium)	E	E	E	E	E	E	-	-	X	G	G	X	X
Ammonia Gas Cold, Dry (to 175 °F)													
Ammonia Gas Cold, Wet (to 480 °F)													
Ammonia Liquid (Anhydrous)													
Ammonia, Aqueous	E	E	G	E	-	E	-	E	-	E	E	-	X
Ammonium Acetate	E												

Underline is cover compound rating only. Many factors, such as temperature, concentration and length of exposure, are relevant to how chemical exposure affects the tube and cover or fitting material. The fluid manufacturers recommended maximum operating temperature should be carefully observed. Exceeding the manufacturer's recommended maximum temperature can result in fluid breakdown and cause harm or shorten life of tube and cover materials. There may be instances where the hose cover could be adversely affected by fluids which would not chemically affect the hose tube. Conversely, some fluids with an adverse affect on the tube of the hose may not have a deteriorating effect on the hose cover. It is recommended that the user test the hose/fluid compatibility to their own standards. Since no industry standards exist for chemical resistance, the Compass Chemical Resistance Guide for Elastomers is used whenever possible. Teflon® is a registered trademark of Dupont.



# Chemical Resistance Tables

The following is a representative list of fluids and manufacturers and a general guideline for the use and compatibility of Continental ContiTech hose and fittings.

### Rating Scale

E = Excellent resistance    X = Not recommended    Blank = No Data  
 G = Good resistance    - = Testing recommended

Chemical Name	Hose								Fittings and Adapters				
	PTFE (Teflon®)	CR (Polychloropene)	NBR (Nitrile)	Nitrile/PVC	CPE	CSM	Urethane	Nylon	Carbon Steel	Stainless Steel 304	Stainless Steel 316	Aluminum	Brass
Ammonium Carbonate													
Ammonium Chloride, 1%	E	X	G	E	E	E	E	E	X	G	G	X	X
Ammonium Chloride, 10% Boiling	E	X	X	-	-	-	-	X	X	G	G	X	X
Ammonium Chloride, 28% Boiling	E	X	X	-	-	-	-	X	X	G	G	X	X
Ammonium Chloride, 50% Boiling	E	X	X	-	-	-	-	X	G	E	E	-	X
Ammonium Hydroxide	E	G	G	G	E	E	X	E	G	E	E	-	X
Ammonium Hydroxide, 3 Molar		E	X	-	-	-	G	-	X	G	G	X	X
Ammonium Hydroxide Concentrated2		E	X	-	E	-	X	E	X	G	G	X	X
Ammonium Metaphosphate	E	G	G	G	-	G	-	-	E	E	E	X	-
Ammonium Nitrate, Fertilizer	E	E	G	E	E	E	E	X	E	E	E	G	X
Ammonium Nitrite		-	-	-	-	-	-	E	G	E	E	X	-
Ammonium Persulfate		X	X	X	E	-	X	X	X	G	G	X	X
Ammonium Persulfate 10%		E	X	-	-	-	X	X	X	G	G	X	X
Ammonium Persulfate 5%		E	X	-	-	-	-	X		G	G	X	X
AmmoniumPhosphate (Mono,Di,Tri,Basic)	E	E	E	E	E	E	E	G	X	G	G	X	-
Ammonium Sulfate	E	E	G	E	E	E	E	X	X	X	G	X	X
Ammonium Sulfide	E	E	E	E	-	E	-	E	E	E	E	E	G
Ammonium Thiocyanate	E	E	E	-	E	E	-	-	E	E	E	-	-
Amyl Chloride	E	X	-	X	G	X	-	G	-	E	E	-	-
Amyl Chloronaphthalene	E	X	X	X	-	X	-	-	-	E	E	-	-
Amyl Naphthalene	E	X	X	X	-	X	-	-	-	E	E	-	-
Amyl Phenol		-	-	-	-	-	-	-	-	E	E	-	-
Amyl Acetate	E	X	X	X	G	X	G	E	X	E	E	X	G
Amyl Alcohol	E	E	E	E	E	E	G	X	X	G	G	G	X
Amyl Borate		G	G	G	-	-	-	-	-	-	-	-	-
AN-0-3 Grade M		E	E	-	-	-	-	-	-	-	-	-	-
AN-0-366		E	E	-	-	-	-	-	-	-	-	-	-
AN-0-6		E	E	-	-	-	-	-	-	-	-	-	-
Anderol, L-774 (Diester)		X	G	-	-	-	-	X	-	-	-	-	-
Anderol, L-826 (Diester)		X	G	-	-	-	-	X	-	-	-	-	-
Anderol, L-829 (Diester)		X	G	-	-	-	-	X	-	-	-	-	-
ANG-25 (Diester Base,TG749)		X	G	-	-	-	-	X	E	E	E	E	-
ANG-25 (Glycerol Ester)		G	G	-	-	-	-	G	-	-	-	-	-

Underline is cover compound rating only. Many factors, such as temperature, concentration and length of exposure, are relevant to how chemical exposure affects the tube and cover or fitting material. The fluid manufacturers recommended maximum operating temperature should be carefully observed. Exceeding the manufacturer's recommended maximum temperature can result in fluid breakdown and cause harm or shorten life of tube and cover materials. There may be instances where the hose cover could be adversely affected by fluids which would not chemically affect the hose tube. Conversely, some fluids with an adverse affect on the tube of the hose may not have a deteriorating effect on the hose cover. It is recommended that the user test the hose/fluid compatibility to their own standards. Since no industry standards exist for chemical resistance, the Compass Chemical Resistance Guide for Elastomers is used whenever possible. Teflon® is a registered trademark of Dupont.

## Chemical Resistance Tables

The following is a representative list of fluids and manufacturers and a general guideline for the use and compatibility of Continental ContiTech hose and fittings.

### Rating Scale

E = Excellent resistance    X = Not recommended    Blank = No Data  
G = Good resistance    - = Testing recommended

Chemical Name	Hose								Fittings and Adapters				
	PTFE (Teflon®)	CR (Polychloropene)	NBR (Nitrile)	Nitrile/ PVC	CPE	CSM	Urethane	Nylon	Carbon Steel	Stainless Steel 304	Stainless Steel 316	Aluminum	Brass
Aniline	E	X	X	X	G	X	X	G	G	E	E	X	X
Aniline Dyes	E												
Animal Fat	E												
Animal Gelatin		E	E	-	E	-	-	-	-	E	E	-	-
Animal Oil (Lard Oil)	E	G	E	-	E	-	-	-	E	E	E	E	-
Antifreeze, Alcohol Base		G	G	G	G	G	-	-	E	E	E	E	-
Antifreeze, Glycol Base	E	G	E	E	E	E	-	E	E	E	E	E	E
Antimony Chloride, 50% (to 70°F)	E	-	E	-	-	-	-	X	X	X	X	-	-
AN-VV-0-366B Hydraulic Fluid		E	-	-	-	-	-	G	-	-	-	-	-
Aqua Regia (Concentrated)	E	X	X	X	G	X	X	X	X	X	X	X	-
Arco A.T.F.Dexron		-	E	-	-	-	-	-	-	-	-	-	-
Arco C2, 100		-	E	-	-	-	-	-	-	-	-	-	-
Argon Gas	E												
Aromatic Fuel 30%, Mil		-	-	-	-	-	-	-	-	-	-	-	-
Aromatic Fuel 50%		X	G	-	-	-	-	-	-	-	-	-	-
Aromatic Hydrocarbons	E	X	X	-	-	X	G	-	G	E	G	G	G
Arsenic Salt (to 70°F)	E												
Askarel, Transformer Oil	-	X	X	X	-	X	-	-	E	E	E	-	E
Asphalt, Cut Back (Including Emulsions)	E	X	G	G	-	X	E	E	E	E	E	G	G
Asphalt, Topping (Including Emulsions)	E	E	X	-	-	-	-	-	E	E	E	-	-
Asphalt, Under 180°F (Including Emulsions)	E	G	G	G	X	X	E	-	E	E	E	-	G
ASTM Oil N° 1	E	E	E	E	E	G	E	E	E	E	E	E	E
ASTM Oil N° 2	E	G	E	-	G	-	E	E	E	E	E	E	E
ASTM Oil N° 3	E	X	E	X	X	X	-	E	E	E	E	E	E
ASTM Oil N° 4	E	X	G	-	-	-	-	-	E	E	E	E	-
ASTM Reference Fuel A (to 300°F)	E	G	E	E	E	E	-	E	E	E	E	E	E
ASTM Reference Fuel B (to 300°F)	E	G	E	G	G	X	-	-	E	E	E	E	E
ASTM Reference Fuel C (to 300°F)	E	X	G	X	G	X	-	-	E	E	E	-	E
ATL-857		X	G	-	-	-	-	-	-	-	-	-	-
Atlantic Dominion F		G	E	-	-	-	-	-	-	-	-	-	-
Aurex 903R (Mobil)		G	E	-	-	-	-	-	-	-	-	-	-
Automatic Brake Fluid		G	X	-	-	-	-	-	E	E	E	E	-

Underline is cover compound rating only. Many factors, such as temperature, concentration and length of exposure, are relevant to how chemical exposure affects the tube and cover or fitting material. The fluid manufacturers recommended maximum operating temperature should be carefully observed. Exceeding the manufacturer's recommended maximum temperature can result in fluid breakdown and cause harm or shorten life of tube and cover materials. There may be instances where the hose cover could be adversely affected by fluids which would not chemically affect the hose tube. Conversely, some fluids with an adverse affect on the tube of the hose may not have a deteriorating effect on the hose cover. It is recommended that the user test the hose/fluid compatibility to their own standards. Since no industry standards exist for chemical resistance, the Compass Chemical Resistance Guide for Elastomers is used whenever possible. Teflon® is a registered trademark of Dupont.

# Chemical Resistance Tables

The following is a representative list of fluids and manufacturers and a general guideline for the use and compatibility of Continental ContiTech hose and fittings.

### Rating Scale

E = Excellent resistance    X = Not recommended    Blank = No Data  
 G = Good resistance    - = Testing recommended

Chemical Name	Hose								Fittings and Adapters				
	PTFE (Teflon®)	CR (Polychloropene)	NBR (Nitrile)	Nitrile/PVC	CPE	CSM	Urethane	Nylon	Carbon Steel	Stainless Steel 304	Stainless Steel 316	Aluminum	Brass
Automatic Transmission Fluid		G	E	-	E	-	-	-	E	E	E	E	-
Aviation Gasoline, Mil		-	G	-	-	-	-	-	E	E	E	E	-
Baltic Types 100, 150, 200, 300, 500			E	-	-	-	-	-	-	-	-	-	-
Barvel Concentrated (Ag Spray)		-	-	-	-	-	-	E	-	-	E	-	-
Bardol B		X	X	X	-	X	-	-	E	E	E	-	-
Barium Chloride	E	X	E	E	E	E	E	E	X	G	G	X	E
Barium Chloride, 5%	E	X	E	-	-	-	-	X	G	E	E	X	G
Barium Chloride, Aqueous Solution (Hot)		X	E	-	-	-	-	X	G	G	G	X	-
Barium Concentrate		E	E	E	E	E	-	E	G	E	E	X	-
Barium Hydroxide	E	E	E	E	E	E	X	E	X	E	E	X	X
Barium Sulfate	E	E	E	-	E	G	-	E	G	E	E	G	G
Barium Sulfate, Aqueous Solution (Hot)	E	X	-	-	-	-	-	X	G	E	E	G	X
Barium Sulfide	E	G	E	E	E	E	-	G	X	E	E	X	-
Baygon													-
Bayol 35		-	E	-	-	-	-	-	-	-	-	-	-
Bayol D		-	E	-	-	-	-	-	-	-	-	-	X
Beer	E												-
Beet Sugar Liquors	E	X	E	E	E	E	X	-	G	G	G	G	E
Bellows 80-20 Hydraulic Oil		-	E	-	-	-	G	-	-	-	-	-	E
Benzaldehyde	E	X	X	X	G	X	E	E	E	E	E	E	E
Benzene, Benzo	E	X	X	X	X	X	G	E	E	E	E	E	-
Benzine, Petroleum Ether		X	G	X	E	-	G	-	E	E	E	E	X
Benzine, Petroleum Naphtha	E												E
Benzoic Acid													G
Benzyl Alcohol	E												X
Black Point 77		-	E	-	-	-	-	-	-	-	-	-	X
Black Sulfate Liquor	E	G	G	G	G	G	-	E	G	E	E	X	-
Blast Furnace Gas	E	X	X	X	-	X	X	-	E	E	E	G	E
Borax, Sodium Borate	E	X	G	G	E	E	E	X	G	E	E	X	E
Bordeaux Mixture	E	G	G	G	-	-	E	E	X	-	E	E	-
Boric Acid	E	E	E	E	-	E	E	X	X	G	G	E	-
Boron Fuels, HEF		X	X	-	-	-	-	-	-	-	-	-	-
Brake Fluid, Petroleum Base (to 300°F)	E	G	E	G	E	X	-	-	E	E	E	-	-

Underline is cover compound rating only. Many factors, such as temperature, concentration and length of exposure, are relevant to how chemical exposure affects the tube and cover or fitting material. The fluid manufacturers recommended maximum operating temperature should be carefully observed. Exceeding the manufacturer's recommended maximum temperature can result in fluid breakdown and cause harm or shorten life of tube and cover materials. There may be instances where the hose cover could be adversely affected by fluids which would not chemically affect the hose tube. Conversely, some fluids with an adverse affect on the tube of the hose may not have a deteriorating effect on the hose cover. It is recommended that the user test the hose/fluid compatibility to their own standards. Since no industry standards exist for chemical resistance, the Compass Chemical Resistance Guide for Elastomers is used whenever possible. Teflon® is a registered trademark of Dupont.

## Chemical Resistance Tables

The following is a representative list of fluids and manufacturers and a general guideline for the use and compatibility of Continental ContiTech hose and fittings.

### Rating Scale

E = Excellent resistance    X = Not recommended    Blank = No Data  
G = Good resistance    - = Testing recommended

Chemical Name	Hose								Fittings and Adapters				
	PTFE (Teflon®)	CR (Polychloropene)	NBR (Nitrile)	Nitrile/ PVC	CPE	CSM	Urethane	Nylon	Carbon Steel	Stainless Steel 304	Stainless Steel 316	Aluminum	Brass
Brake Fluid, Synthetic Base		X	X	X	E	X	-	-	E	E	E	E	-
Bray GG-130		X	G	-	-	-	-	-	-	-	-	-	-
Brayco 719-r (VV-H-910)		G	X	-	-	-	-	-	-	-	-	-	E
Brayco 885 (MIL-L-6085A)		X	G	-	-	-	-	-	-	-	-	-	-
Brayco 910		G	G	-	-	-	-	-	-	-	-	-	E
Brine	E												E
Brom-113		X	G	-	-	-	-	-	-	-	-	-	-
Brom-114		G	G	-	-	-	-	-	-	-	-	-	X
Bromine (Permiable)	E												X
Bunker Oil	E	X	G	G	-	X	G	-	E	E	E	E	X
Butane	E	X	X	X	-	X	X	X	X	-	-	-	E
Butanone, MEK													-
Butyl Acetate	E	X	X	X	G	X	-	-	G	E	E	E	X
Butyl Acetate	E												G
Butyl Alcohol, Butanol	E												X
Butyl Cellosolve	E												X
Butyl Stearate	E												X
Butylene ( Permiable )	E												X
Butyraldehyde	E												X
Cadmium Salts (to 70°F)	E												
Calcium Acetate	E	X	X	X	E	X	-	-	G	G	G	X	E
Calcium Arsenate	-	-	-	-	-	-	E	E	-	-	-	-	E
Calcium Bisulfate	E	E	E	G	E	E	-	-	-	G	E	-	E
Calcium Bisulfide	E	E	E	G	E	E	E	-	-	G	G	X	-
Calcium Bisulfite	E	E	E	E	E	E	-	E	X	E	E	E	G
Calcium Carbonate	E	E	E	E	E	E	E	E	G	E	E	X	X
Calcium Chlorate	E	E	E	E	-	E	-	-	G	G	E	E	E
Calcium Chloride	E	E	E	E	E	E	E	E	X	G	G	X	E
Calcium Hydroxide	E	E	G	G	E	E	X	-	X	X	E	-	X
Calcium Hydroxide, 10% Boiling		-	G	-	-	-	-	X	G	E	E	X	E
Calcium Hydroxide, 20% Boiling		-	-	-	-	-	-	X	-	E	E	X	-
Calcium Hydroxide, 50% Boiling		-	-	-	-	-	-	X	-	X	G	X	G
Calcium Hypochlorite, 15% (Under 100°F)	E	X	-	X	E	G	-	X	-	X	G	X	X
Calcium Hypochlorite, 5% (Under 100°F)	E	X	G	X	E	G	-	X	X	X	G	X	E

Underline is cover compound rating only. Many factors, such as temperature, concentration and length of exposure, are relevant to how chemical exposure affects the tube and cover or fitting material. The fluid manufacturers recommended maximum operating temperature should be carefully observed. Exceeding the manufacturer's recommended maximum temperature can result in fluid breakdown and cause harm or shorten life of tube and cover materials. There may be instances where the hose cover could be adversely affected by fluids which would not chemically affect the hose tube. Conversely, some fluids with an adverse affect on the tube of the hose may not have a deteriorating effect on the hose cover. It is recommended that the user test the hose/fluid compatibility to their own standards. Since no industry standards exist for chemical resistance, the Compass Chemical Resistance Guide for Elastomers is used whenever possible. Teflon® is a registered trademark of Dupont.

# Chemical Resistance Tables

The following is a representative list of fluids and manufacturers and a general guideline for the use and compatibility of Continental ContiTech hose and fittings.

## Rating Scale

E = Excellent resistance    X = Not recommended    Blank = No Data  
G = Good resistance    - = Testing recommended

Chemical Name	Hose								Fittings and Adapters				
	PTFE (Teflon®)	CR (Polychloropene)	NBR (Nitrile)	Nitrile/ PVC	CPE	CSM	Urethane	Nylon	Carbon Steel	Stainless Steel 304	Stainless Steel 316	Aluminum	Brass
Calcium Nitrate	E	E	E	E	E	E	-	E	X	G	G	X	X
Calcium Salts (to 70°F)	E												
Calcium Silicate	E	-	G	-	E	G	-	-	E	E	E	E	X
Calcium Sulfate	E	E	E	E	E	E	-	-	G	E	E	G	-
Calcium Sulfide	E	E	G	-	E	-	-	G	G	E	E	G	X
Caliche Liquors E	E												
Cane Sugar Liquors	E	E	E	G	E	E	E	-	E	E	E	E	G
Carbitol													
Carbolic Acid, Phenol	E	X	X	X	E	X	X	X	X	E	E	G	X
Carbon Bisulfide	E												
Carbon Dioxide, Dry	E	G	E	E	E	E	E	-	E	E	E	E	E
Carbon Dioxide, Wet	E	G	E	E	E	E	-	-	E	E	E	E	E
Carbon Disulfide	-	X	X	-	-	X	G	E	G	E	E	G	-
Carbon Monoxide, (Under 150°F) (Hot)	E	G	G	G	E	E	-	G	E	E	E	E	-
Carbon Tetrachloride, 5-10%	E	-	-	-	-	-	-	-	-	X	-	-	X
Carbon Tetrachloride, Pure	E	X	X	X	G	X	X	X	X	X	G	G	-
Carbonic Acid	E	E	E	E	E	E	X	-	X	E	E	G	-
Castor Oil	E	G	G	G	E	G	G	E	G	E	E	E	G
Caustic Soda, 20%	E	G	X	X	E	E	X	G	G	E	E	X	E
Caustic Soda, 50%	E	G	X	X	E	E	X	G	G	E	E	X	E
Cellosolve Acetate, Under 100°F	E	X	X	X	G	X	-	-	G	G	G	E	E
Cellosolve Butyl, Under 100°F	E	X	X	X	-	X	-	-	G	G	G	G	E
Cellosolve Union Carbide, Under 100°F	E	X	X	-	-	-	-	-	G	G	G	G	-
Cellugard, Cellugard 200		E	E	-	-	-	-	-	-	X	X	-	X
Cellulube 1000, 220A, ST220, A60 (to 70°F)	E	X	X	X	-	X	-	-	E	E	E	E	X
Cellulube 90, 150, 220,300, 551 (to 70°F)	E	X	X	X	-	X	-	-	E	E	E	E	X
Cellutherm 2505A	-	X	G	-	-	-	-	-	-	-	-	-	X
Chevron FR-10,13, 20, 8													
China wood Oil (Tung)	E												
Chlor Acetone													
Chlordane (to 70°F)	E	X	X	X	-	X	-	E	-	-	-	X	X
Chlorinated Paraffine													
Chlorinated Solvents – Dry (to 212°F)	E												

Underline is cover compound rating only. Many factors, such as temperature, concentration and length of exposure, are relevant to how chemical exposure affects the tube and cover or fitting material. The fluid manufacturers recommended maximum operating temperature should be carefully observed. Exceeding the manufacturer's recommended maximum temperature can result in fluid breakdown and cause harm or shorten life of tube and cover materials. There may be instances where the hose cover could be adversely affected by fluids which would not chemically affect the hose tube. Conversely, some fluids with an adverse affect on the tube of the hose may not have a deteriorating effect on the hose cover. It is recommended that the user test the hose/fluid compatibility to their own standards. Since no industry standards exist for chemical resistance, the Compass Chemical Resistance Guide for Elastomers is used whenever possible. Teflon® is a registered trademark of Dupont.

# Chemical Resistance Tables

The following is a representative list of fluids and manufacturers and a general guideline for the use and compatibility of Continental ContiTech hose and fittings.

## Rating Scale

E = Excellent resistance    X = Not recommended    Blank = No Data  
G = Good resistance    - = Testing recommended

Chemical Name	Hose								Fittings and Adapters				
	PTFE (Teflon®)	CR (Polychloroprene)	NBR (Nitrile)	Nitrile/ PVC	CPE	CSM	Urethane	Nylon	Carbon Steel	Stainless Steel 304	Stainless Steel 316	Aluminum	Brass
Chlorinated Solvents - Wet (to 70°F)	E												
Chlorine Gas, (Under 212°F)			X	-	-	-	-	-	-	X	X	-	-
Chlorine Trifluoride (to 70°F)	E	X	X	-	-	-	-	-	E	E	E	E	-
Chlorine Water, 25% Chlorine		X	X	X	-	G	G	X	-	X	X	-	E
Chloroacetic Acid (Under 100°F)	E	X	X	X	-	G	-	X	X	X	X	X	E
Chlorobenzene	E	X	X	X	X	X	-	X	G	G	G	X	E
Chlorobromo Methane	E	X	X	X	-	X	-	-	G	G	G	X	G
Chloroform	E	X	X	X	X	X	-	X	G	E	E	X	X
Chlorosulphonic Acid	E												
Chlorotoluene	E	X	X	X	X	X	X	-	G	G	G	X	X
Chlorox, Bleach		G	G	-	E	G	-	E	X	G	E	X	X
Chromic Acid, 10%	E	X	X	X	E	G	X	X	X	X	G	X	X
Chromic Acid, 100%	E	-	-	-	-	-	X	-	X	X	X	X	X
Chromic Acid, 25%	E	X	X	X	E	G	X	X	X	X	G	X	X
Chromic Acid, 5%	E	X	X	-	-	-	-	X	X	G	E	X	X
Chromic Acid, 50%	E	X	X	X	E	G	X	X	X	X	X	X	X
Chromium Potassium Sulfate													
Cider													
Circo Light Process Oil		E	E	-	-	-	-	-	E	E	E	E	-
Citgo FR Fluids			X	-	-	-	G	-	-	-	-	-	-
Citgo FR15, 20,25													
Citgo Glycol FR-20XD			E	-	-	-	G	-	E	E	E	E	E
Citgo Pacemaker FR													
Citgo Pacemaker Glicol													
Citgo Sentry, (Under 100°F)		G	G	E	-	X	G	-	E	E	E	-	E
Citgo Tractor Hydraulic Fluid			E	-	-	-	G	-	E	E	E	-	E
Citric Acid, 15%	E		G	-	-	-	-	E	X	E	E	-	X
Citric Acid, 15% Boiling	E		G	-	-	-	-	X	X	G	E	X	X
Citric Acid, 5%	-		G	-	-	-	-	E	X	E	E	E	X
Citric Acid, 5% @150°F	-		G	-	-	-	-	X	X	E	E	G	X
Citric Acid, Concentrated													
Boiling		E	X	E	-	E	G	X	X	X	G	X	X
Coal Gas		E	X	-	E	-	E	-	-	-	-	-	-
Coal Tars		X	G	X	G	G	-	-	E	E	E	E	E
Codor 1000, 1002, 1004, 1006, 1008			G	-	-	-	-	-	-	-	-	-	-
Coke Oven Gas (Under 100°F)	E	X	G	X	-	G	-	-	E	E	E	G	-

Underline is cover compound rating only. Many factors, such as temperature, concentration and length of exposure, are relevant to how chemical exposure affects the tube and cover or fitting material. The fluid manufacturers recommended maximum operating temperature should be carefully observed. Exceeding the manufacturer's recommended maximum temperature can result in fluid breakdown and cause harm or shorten life of tube and cover materials. There may be instances where the hose cover could be adversely affected by fluids which would not chemically affect the hose tube. Conversely, some fluids with an adverse affect on the tube of the hose may not have a deteriorating effect on the hose cover. It is recommended that the user test the hose/fluid compatibility to their own standards. Since no industry standards exist for chemical resistance, the Compass Chemical Resistance Guide for Elastomers is used whenever possible. Teflon® is a registered trademark of Dupont.

# Chemical Resistance Tables

The following is a representative list of fluids and manufacturers and a general guideline for the use and compatibility of Continental ContiTech hose and fittings.

### Rating Scale

E = Excellent resistance    X = Not recommended    Blank = No Data  
 G = Good resistance    - = Testing recommended

Chemical Name	Hose								Fittings and Adapters				
	PTFE (Teflon®)	CR (Polychloropene)	NBR (Nitrile)	Nitrile/PVC	CPE	CSM	Urethane	Nylon	Carbon Steel	Stainless Steel 304	Stainless Steel 316	Aluminum	Brass
Conor 1008, 1010, 1012, 1014, 1016		-	G	-	-	-	-	-	-	-	-	-	-
Convelex 10		X	X	-	-	-	-	-	-	-	-	-	-
Copper Arsenate, Cupric Arsenate		-	-	-	-	G	-	-	E	E	E	-	-
Copper Chloride, 1%		E	E	-	-	-	-	X	-	G	G	-	-
Copper Chloride, 5%	E	E	E	-	-	-	-	X	-	X	G	-	-
Copper Chloride, Cupric Chloride	E	G	G	G	G	G	E	G	X	X	E	-	X
Copper Cyanide, Cupric Cyanide	E	G	G	G	-	G	-	X	E	E	E	-	X
Copper Nitrate, 1% & 5%	E	E	E	-	-	-	-	E	X	E	E	X	X
Copper Nitrate, Cupric Nitrate		E	E	E	E	E	-	-	X	E	E	-	X
Copper Sulfate, 10%	E	E	E	-	-	-	-	-	X	G	G	X	-
Copper Sulfate, 50%	E	E	E	-	-	-	-	-	-	G	G	-	-
Copper Sulfate, Cupric Sulfate		E	E	E	E	E	E	E	X	E	E	X	X
Corn Oil	E	X	G	G	G	X	X	-	E	E	E	E	E
Cosmolubric													
Cottonseed Oil	E	G	G	E	G	G	X	G	E	E	E	E	E
Creosol	E												
Creosote, Wood or Coal Tar (Under 100°F)	E	X	G	X	-	X	X	X	G	E	E	E	X
Cresol, Cresylic Acid (Under 100°F)	E	X	X	X	E	X	-	X	G	E	E	G	-
Crude Petroleum Oil	E	X	X	G	G	G	G	-	E	E	E	E	E
Cutting Oil	E	G	E	G	E	X	-	-	E	E	E	-	E
Cutting Oil, Sulfur Base	E	X	E	-	-	-	-	-	E	E	E	E	-
Cutting Oil, Water Soluble	E	X	E	-	-	-	-	-	E	E	E	E	-
Cyclohexane	E	X	G	-	E	X	E	E	G	G	G	G	-
Cyclohexanol	E												
Cyclohexanone	E	X	X	X	G	X	E	E	G	G	G	G	-
Cymene	E	X	X	X	G	X	-	-	E	E	E	E	E
Dasco FR 300													
Dasco FR150, FR200, FR200B, FR310		-	E	-	-	-	-	E	-	-	-	-	-
Dasco IFR		-	E	-	-	-	-	E	E	-	-	E	E
DDT Preparation (to 70°F) (in Kerosene)	E												
Decalin	E	X	G	-	G	X	-	E	-	-	-	-	E

Underline is cover compound rating only. Many factors, such as temperature, concentration and length of exposure, are relevant to how chemical exposure affects the tube and cover or fitting material. The fluid manufacturers recommended maximum operating temperature should be carefully observed. Exceeding the manufacturer's recommended maximum temperature can result in fluid breakdown and cause harm or shorten life of tube and cover materials. There may be instances where the hose cover could be adversely affected by fluids which would not chemically affect the hose tube. Conversely, some fluids with an adverse affect on the tube of the hose may not have a deteriorating effect on the hose cover. It is recommended that the user test the hose/fluid compatibility to their own standards. Since no industry standards exist for chemical resistance, the Compass Chemical Resistance Guide for Elastomers is used whenever possible. Teflon® is a registered trademark of Dupont.

## Chemical Resistance Tables

The following is a representative list of fluids and manufacturers and a general guideline for the use and compatibility of Continental ContiTech hose and fittings.

### Rating Scale

E = Excellent resistance    X = Not recommended    Blank = No Data  
G = Good resistance    - = Testing recommended

Chemical Name	Hose								Fittings and Adapters				
	PTFE (Teflon®)	CR (Polychloropene)	NBR (Nitrile)	Nitrile/ PVC	CPE	CSM	Urethane	Nylon	Carbon Steel	Stainless Steel 304	Stainless Steel 316	Aluminum	Brass
Dectol R&O Oil		X	E	-	-	-	G	-	-	-	-	-	-
Deionized Water													
Detergent / water Solution	E												
Developing Fluids, Photo	E	G	-	-	E	G	-	-	-	E	E	-	-
Developing Solutions, Hypos	E	G	-	-	E	G	-	-	-	E	E	-	-
Dextron AFT													
Diacetone	E	X	X	X	E	X	-	E	E	E	E	E	E
Diammonium Phosphate ( to 70°F)	E												
Dibenzyl Ether	E												
Dibutyl Ether	E												
Dibutyl Phthalate (Under 120°F)	E	X	X	X	G	X	G	-	E	E	E	E	E
Dichlorobenzene	E	X	X	X	X	X	X	-	E	E	E	X	E
Dichloroethylene	E												
Dieldrin													
Diesel Oil, Fuel ASTM #2	E	G	E	G	G	X	E	E	E	E	E	E	E
Diester Lubricant MIL-I-7809		X	G	-	-	-	-	-	E	E	E	E	-
Diester Synthetic Lubricants		X	G	-	-	-	-	-	E	E	E	E	-
Diethanolamine, 20%	E												
Diethyl Ether ( Permiabie )	E												
Diethyl Sebacate	E												
Diethylamine (Under 120°F)	E	G	G	-	G	X	-	E	E	E	E	E	E
Diethylene Glycol	E	E	E	E	E	E	E	E	E	E	E	E	E
Diisobutyl Ketone	E	X	X	X	G	X	-	E	E	E	E	E	E
Diisobutylene	E	X	G	-	E	X	-	-	G	E	E	G	E
Diisopropyl Ketone		X	X	X	G	X	-	E	E	E	E	E	E
Dimethyk Benzol													
Dimethyl Aniline	E	X	X	X	G	X	-	-	-	-	-	-	E
Dimethyl Formamide													
(Under 120°F)	-	X	X	X	-	-	-	-	E	E	E	E	-
Dimethyl Phthalate	E	X	X	X	E	X	-	-	-	-	G	-	E
Diocetyl Phthalate (DOP)	E	X	X	X	G	X	-	-	E	E	E	E	E
Diocetyl Sebacate		X	X	X	X	X	-	-	E	E	E	E	-
Diocetylphospjate													
Dipentene	E	X	X	-	G	-	-	-	E	E	E	E	E
Dirco Oils		-	E	-	-	-	-	E	E	E	E	E	E
Dispersing Oil #10		X	X	-	-	-	-	-	E	E	E	E	-
Dow Corning C200,DC510,DC550,DC560		-	E	-	-	-	-	E	-	E	E	E	E

Underline is cover compound rating only. Many factors, such as temperature, concentration and length of exposure, are relevant to how chemical exposure affects the tube and cover or fitting material. The fluid manufacturers recommended maximum operating temperature should be carefully observed. Exceeding the manufacturer's recommended maximum temperature can result in fluid breakdown and cause harm or shorten life of tube and cover materials. There may be instances where the hose cover could be adversely affected by fluids which would not chemically affect the hose tube. Conversely, some fluids with an adverse affect on the tube of the hose may not have a deteriorating effect on the hose cover. It is recommended that the user test the hose/fluid compatibility to their own standards. Since no industry standards exist for chemical resistance, the Compass Chemical Resistance Guide for Elastomers is used whenever possible. Teflon® is a registered trademark of Dupont.



# Chemical Resistance Tables

The following is a representative list of fluids and manufacturers and a general guideline for the use and compatibility of Continental ContiTech hose and fittings.

### Rating Scale

**E** = Excellent resistance    **X** = Not recommended    **Blank** = No Data  
**G** = Good resistance    **-** = Testing recommended

Chemical Name	Hose								Fittings and Adapters				
	PTFE (Teflon®)	CR (Polychloropene)	NBR (Nitrile)	Nitrile/ PVC	CPE	CSM	Urethane	Nylon	Carbon Steel	Stainless Steel 304	Stainless Steel 316	Aluminum	Brass
Dow HD 50-4													
Dow Therm 209													
Dowtherm A	E	X	X	X	G	X	X	-	E	E	E	E	E
Dowtherm E		X	X	-	G	-	-	-	E	E	E	E	E
DP47, 200 Flow-DOW		-	E	-	-	-	-	E	E	E	E	E	E
Duro AW-16, 31													
Duro FR-HD		-	E	-	-	-	X	E	-	-	-	-	-
Duro Oils		-	E	-	-	-	-	E	E	E	E	E	E
Elco 28-EP, Lubricant		X	E	-	-	-	-	-	E	E	E	E	-
Enamels	-E	-	-	-	-	-	E	-	-	-	-	E	-
Energol HL 68		-	E	-	-	-	-	-	E	E	E	E	E
Energol HLPC 68		-	E	-	-	-	-	-	E	E	E	E	E
EP Hydraulic Oils, Chevron		-	E	-	-	-	-	-	E	E	E	E	E
Epichlorohydrin (Under 120°F)		X	X	-	-	-	-	-	E	G	E	E	-
Esam-6 Fluid		G	-	-	-	-	-	-	-	-	-	-	-
Ethanoic Acid	E												
Ethanol	E	E	E	-	E	-	X	E	-	-	-	-	-
Ethanolamine, Aminoethanol	E	G	G	-	E	X	X	E	E	E	E	E	E
Ethers (Under 120°F)	E	X	G	X	E	G	G	E	E	E	E	E	E
Ethyl Acetate	E	X	X	X	G	X	G	E	E	E	E	G	G
Ethyl Acetoacetate	E	X	X	X	E	X	X	-	E	E	E	E	E
Ethyl Acrylate	E	X	X	X	G	X	X	-	E	E	E	E	-
Ethyl Alcohol	E												
Ethyl Amine, Monoethylamine	E	X	X	X	E	X	X	-	G	E	E	G	E
Ethyl Benzene	E	X	X	X	G	X	E	-	E	E	E	E	E
Ethyl Bromide, Di	E	X	X	X	G	X	-	-	E	E	E	E	E
Ethyl Butyrate	E	X	X	X	-	-	-	-	-	E	E	E	-
Ethyl Cellulose	E	-	-	-	E	-	-	-	E	E	E	-	E
Ethyl Chloride	E	X	X	X	-	X	X	-	G	E	E	E	G
Ethyl Chloride, Dry	E	E	X	-	-	-	X	E	E	E	E	E	-
Ethyl Chloride, Wet	E	G	X	-	-	-	-	E	-	E	E	E	E
Ethyl Mercaptan	E	X	X	X	-	X	X	-	G	G	G	G	-
Ethyl Oxalate		X	X	-	E	-	E	-	-	-	-	-	-
Ethyl Pentachlorobenzene	E	-	X	-	X	-	E	-	-	-	-	-	-
Ethyl Silicate (to 70°F)	E	E	E	E	E	-	E	-	E	E	E	G	E
Ethylene Chlorohydrin, (Under 100°F)	E	X	X	X	-	-	X	X	E	E	G	X	-

Underline is cover compound rating only. Many factors, such as temperature, concentration and length of exposure, are relevant to how chemical exposure affects the tube and cover or fitting material. The fluid manufacturers recommended maximum operating temperature should be carefully observed. Exceeding the manufacturer's recommended maximum temperature can result in fluid breakdown and cause harm or shorten life of tube and cover materials. There may be instances where the hose cover could be adversely affected by fluids which would not chemically affect the hose tube. Conversely, some fluids with an adverse affect on the tube of the hose may not have a deteriorating effect on the hose cover. It is recommended that the user test the hose/fluid compatibility to their own standards. Since no industry standards exist for chemical resistance, the Compass Chemical Resistance Guide for Elastomers is used whenever possible. Teflon® is a registered trademark of Dupont.

## Chemical Resistance Tables

The following is a representative list of fluids and manufacturers and a general guideline for the use and compatibility of Continental ContiTech hose and fittings.

### Rating Scale

E = Excellent resistance    X = Not recommended    Blank = No Data  
G = Good resistance    - = Testing recommended

Chemical Name	Hose								Fittings and Adapters				
	PTFE (Teflon®)	CR (Polychloropene)	NBR (Nitrile)	Nitrile/ PVC	CPE	CSM	Urethane	Nylon	Carbon Steel	Stainless Steel 304	Stainless Steel 316	Aluminum	Brass
Ethylene Diamine (Under 100°F)	E	G	G	G	E	X	X	-	E	E	E	X	E
Ethylene Dichloride (Permeable)	E	X	X	-	G	-	E	E	-	E	E	X	-
Ethylene Glycol	E	E	E	E	E	E	E	E	G	E	E	E	E
Ethylene Glycol, Ethyl Ether	E												
Ethylene Oxide	E												
Exxon Univolt 60, N61													
Factovis 52		-	E	-	-	-	-	-	E	E	E	E	E
Fatty Acids	E	G	G	G	G	X	E	E	X	G	E	E	-
Ferric Chloride	E	-	-	-	E	G	-	-	X	X	X	X	X
Ferric Chloride, 1%		E	E	-	-	-	-	E	X	G	G	X	X
Ferric Chloride, 1% boiling		-	G	-	-	-	-	E	X	X	X	X	X
Ferric Chloride, 10%		G	E	-	-	-	-	E	X	X	X	X	X
Ferric Chloride, 5% Agitated or Aerated		G	G	-	-	-	-	E	X	X	X	X	X
Ferric Chloride, 5% Still		G	E	-	-	-	-	E	X	X	X	X	X
Ferric Sulfate	E	G	G	G	E	G	-	E	X	G	G	X	X
Ferrous Sulfate, Saturated	E	E	-	-	-	-	-	E	-	G	G	X	-
Ferrous Chloride	E	E	E	-	E	G	-	E	X	X	G	X	X
Ferrous Nitrate	E	G	G	G	-	G	-	-	-	E	E	-	-
Ferrous Salt Solutions	E												
Ferrous Sulfate, 10%	E	E	E	-	-	-	-	E	X	G	G	X	-
Ferrous Sulfate, Copper Gas	E	G	G	G	E	G	-	-	X	E	E	E	G
Fire Resistant Hydraulic Fluid, Texaco		-	E	-	-	-	-	-	E	E	E	E	E
Fire Safe, 225, 211													
Fire Safe, 1090E,1150,1220,1300E,155													
Firtec 290, MF		-	-	-	-	-	-	-	-	-	-	-	-
Fixing Solution, Photo		G	-	-	-	G	-	-	-	E	E	-	-
Flactid Acid													
Fluoboric Acid	E	E	E	-	E	-	-	-	E	-	E	X	-
Fluoboric Acid, 65%	E	G	-	-	E	G	X	-	-	E	E	-	-
Fluorine Gas, Dry or Wet	G												
Fluosilic Acid		G	E	-	-	-	-	-	X	X	X	X	E
Fluosilic Acid, 50%		G	X	X	E	G	X	X	-	-	-	E	-
Formaldehyde	E	E	X	-	E	-	-	G	E	E	E	E	X
Formaldehyde, 37%		G	-G	-	E	G	-G	-	-	E	E	E	E
Formaldehyde, Hot		-	-	-	-	-	-	E	X	G	E	G	E

Underline is cover compound rating only. Many factors, such as temperature, concentration and length of exposure, are relevant to how chemical exposure affects the tube and cover or fitting material. The fluid manufacturers recommended maximum operating temperature should be carefully observed. Exceeding the manufacturer's recommended maximum temperature can result in fluid breakdown and cause harm or shorten life of tube and cover materials. There may be instances where the hose cover could be adversely affected by fluids which would not chemically affect the hose tube. Conversely, some fluids with an adverse affect on the tube of the hose may not have a deteriorating effect on the hose cover. It is recommended that the user test the hose/fluid compatibility to their own standards. Since no industry standards exist for chemical resistance, the Compass Chemical Resistance Guide for Elastomers is used whenever possible. Teflon® is a registered trademark of Dupont.

# Chemical Resistance Tables

The following is a representative list of fluids and manufacturers and a general guideline for the use and compatibility of Continental ContiTech hose and fittings.

### Rating Scale

E = Excellent resistance    X = Not recommended    Blank = No Data  
 G = Good resistance    - = Testing recommended

Chemical Name	Hose								Fittings and Adapters				
	PTFE (Teflon®)	CR (Polychloropene)	NBR (Nitrile)	Nitrile/ PVC	CPE	CSM	Urethane	Nylon	Carbon Steel	Stainless Steel 304	Stainless Steel 316	Aluminum	Brass
Formic Acid (Under 120°F)	E	E	X	E	E	G	X	G	X	G	E	E	G
Formic Acid, Dilute Hot		E	X	-	-	-	-	X	X	G	E	G	X
Freon 113 ( Permiabile)			Use Freon Hose Only										
Freon 114 ( Permiabile)	G		Use Freon Hose Only										
Freon 12 ( Permiabile )	G		Use Freon Hose Only										
Freon 22 ( Permiabile )			Use Freon Hose Only										
Freon 502 ( Permiabile )			Use Freon Hose Only										
Fuel Oil	E	G	E	E	E	X	G	E	G	G	G	E	G
Fumaric Acid	E	G	X	-	-	-	X	-	E	E	E	-	-
Furan, Furfuran	E	X	X	X	E	-	-	-	E	E	E	E	E
Furfural	E												
Furfural Alcohol, Ant Oil	E	G	X	X	E	G	-	E	G	E	E	E	E
Fusel oil, Grain Oil		X	X	-	-	-	-	-	-	-	-	-	-
Fyran Resin		X	X	-	-	-	-	-	-	-	E	-	-
Fyre Safe W/O													
Fyrguard 150, 200		-	E	-	-	-	-	-	E	E	E	E	E
Fyrquel 1000, 15R&O, 220R&O, 550R&O		X	X	-	-	-	-	-	E	-	-	E	-
Fyrquel A60, 90, 100, 150, 220, 300, 500		X	X	-	-	-	-	-	E	-	-	E	-
Gallic Acid	E	X	X	X	E	-	X	G	X	E	E	X	-
Gas Oil	E												
Gas, Natural	E	-	-	-	X	-	-	-	E	E	E	-	G
Gasohol ( to 200°F)	E	G	X	X	-	X	-	-	G	E	E	E	E
Gasoline Unleaded, Under 50% Aromatics	E	X	X	X	-	X	X	-	G	E	E	E	E
Gasoline, Aviation	E	X	-	G	-	-	-	-	-	E	E	E	E
Gasoline, Meter		X	X	-	-	-	-	X	E	E	E	E	X
Gasoline, Premium	E	G	X	X	-	X	X	-	G	E	E	E	E
Gasoline, Sour	E	X	X	-	-	-	-	-	G	E	E	X	-
Gasoline, Standard	E	E	X	X	G	X	X	-	G	E	E	E	E
Gelatin	E	E	E	-	-	-	-	E	E	E	E	E	X
Glauber's Salt	-	G	X	-	-	-	-	-	E	E	E	-	-
Glucose	E	E	E	E	-	E	E	E	E	E	E	E	E
Glue (Under 120°F)	E	G	G	G	-	E	E	G	G	E	E	G	X
Glycerine, Glycol	E	E	E	E	E	E	E	E	G	E	E	E	G
Glycol FR Fluids	E	-	E	-	-	-	-	-	E	E	E	E	E
Glysantine													
Grease, Ester Base		-	-	-	-	-	-	E	E	E	E	E	E

Underline is cover compound rating only. Many factors, such as temperature, concentration and length of exposure, are relevant to how chemical exposure affects the tube and cover or fitting material. The fluid manufacturers recommended maximum operating temperature should be carefully observed. Exceeding the manufacturer's recommended maximum temperature can result in fluid breakdown and cause harm or shorten life of tube and cover materials. There may be instances where the hose cover could be adversely affected by fluids which would not chemically affect the hose tube. Conversely, some fluids with an adverse affect on the tube of the hose may not have a deteriorating effect on the hose cover. It is recommended that the user test the hose/fluid compatibility to their own standards. Since no industry standards exist for chemical resistance, the Compass Chemical Resistance Guide for Elastomers is used whenever possible. Teflon® is a registered trademark of Dupont.

# Chemical Resistance Tables

The following is a representative list of fluids and manufacturers and a general guideline for the use and compatibility of Continental ContiTech hose and fittings.

## Rating Scale

E = Excellent resistance    X = Not recommended    Blank = No Data  
G = Good resistance    - = Testing recommended

Chemical Name	Hose								Fittings and Adapters				
	PTFE (Teflon®)	CR (Polychloropene)	NBR (Nitrile)	Nitrile/PVC	CPE	CSM	Urethane	Nylon	Carbon Steel	Stainless Steel 304	Stainless Steel 316	Aluminum	Brass
Grease, Petroleum Base	E	G	E	G	-	G	E	E	E	E	E	E	E
Grease, Silicone Base		-	-	-	-	-	-	E	E	E	E	E	E
Green Sulfate Liquor, Under 120°F			G	E	G	-	-	-	E	E	E	-	-
Gulf FR Fluid G-200 (to 70°F)	E	-	E	-	-	-	X	-	E	E	E	E	E
Gulf FR Fluid P37, P40, P43, P45, P47 (to 70°F)	E	-	X	-	-	-	X	-	-	-	-	-	-
Gycols (Under 120°F)		E	E	E	E	E	E	E	G	E	E	E	E
H 515 (NATO)													
Halon													
Halowax Oil		X	X	X	-	X	-	-	-	-	-	-	-
Helium	E												
Hephtachlor, In Petroleum		-	G	X	-	-	-	-	-	-	-	-	-
Heptane (Under 100°F)	E	G	E	G	E	X	E	E	E	E	E	E	E
Hexane (Under 120°F)	E	G	E	G	G	E	E	E	E	E	E	E	E
Hexene	E	G	G	-	E	-	-	-	E	E	E	-	E
HF 20													
High Viscosity Lubricant, H2		G	E	-	-	-	-	-	-	-	-	-	-
High Viscosity Lubricant, U4		G	E	-	-	-	-	-	-	-	-	-	-
Hilo MS #1		X	X	-	-	-	-	-	-	-	-	-	-
Houghto-Safe 1010, 1055, (Phos, Ester) (to 70°F)	E	X	X	X	E	X	-	-	E	E	E	E	E
Houghto-Safe 1115, 1120, 1130, (Phos, Ester) (to 70°F)	E	X	X	X	E	X	-	-	E	E	E	E	E
Houghto-Safe 271, 416, 520, 616, (Water/Glycol) (to 70°F)	E	G	E	E	-	-	G	-	E	E	E	E	E
Hul-E-Mul													
Hy-Chock Oil		-	G	-	-	-	-	E	E	E	E	-	-
Hydrafluid 760, Texaco & Houghton		-	E	-	-	-	-	E	E	E	E	E	-
Hydrafluid AZR&O, A, B, AA, C		-	E	-	-	-	-	E	E	E	E	-	-
Hydrasol A		-	E	-	-	-	-	E	E	E	E	-	-
Hydraulic Fluid HF-18, HF-20		-	E	-	-	-	G	E	E	E	E	E	E
Hydraulic Fluid HF-31		-	-	-	-	-	-	E	E	E	E	E	E
Hydraulic Fluid, Phosphate Ester Base		X	X	X	E	-	X	E	E	E	E	-	-
Hydraulic Fluid, Std Petroleum Oils		G	E	G	E	G	G	E	E	E	E	E	E

Underline is cover compound rating only. Many factors, such as temperature, concentration and length of exposure, are relevant to how chemical exposure affects the tube and cover or fitting material. The fluid manufacturers recommended maximum operating temperature should be carefully observed. Exceeding the manufacturer's recommended maximum temperature can result in fluid breakdown and cause harm or shorten life of tube and cover materials. There may be instances where the hose cover could be adversely affected by fluids which would not chemically affect the hose tube. Conversely, some fluids with an adverse affect on the tube of the hose may not have a deteriorating effect on the hose cover. It is recommended that the user test the hose/fluid compatibility to their own standards. Since no industry standards exist for chemical resistance, the Compass Chemical Resistance Guide for Elastomers is used whenever possible. Teflon® is a registered trademark of Dupont.

# Chemical Resistance Tables

The following is a representative list of fluids and manufacturers and a general guideline for the use and compatibility of Continental ContiTech hose and fittings.

### Rating Scale

E = Excellent resistance    X = Not recommended    Blank = No Data  
 G = Good resistance    - = Testing recommended

Chemical Name	Hose								Fittings and Adapters				
	PTFE (Teflon®)	CR (Polychloropene)	NBR (Nitrile)	Nitrile/PVC	CPE	CSM	Urethane	Nylon	Carbon Steel	Stainless Steel 304	Stainless Steel 316	Aluminum	Brass
Hydraulic Fluid,													
Water Glycol Base		E	E	E	-	-	E	E	E	E	E	E	E
Hydraulic Oils, Petroleum	E	G	E	-	-	-	-	E	E	E	E	E	E
Hydraulic Oils, Synthetic	E	-	X	-	-	-	-	-	E	E	E	E	E
Hydraulic Safety Fluid													
200&300 Texaco		-	E	-	-	-	E	-	E	E	E	E	E
Hydrazine	E	X	X	X	-	X	-	-	X	E	E	E	-
Hydrobromic Acid		X	X	-	-	-	-	-	X	X	X	X	X
Hydrobromic Acid, 37%		X	X	X	E	G	X	X	X	X	X	X	X
Hydrochloric Acid ( Permiabie)	E	G	X	-	-	-	-	X	X	X	X	X	X
Hydrochloric Acid .15%	E	X	X	X	E	G	X	X	X	X	X	X	X
Hydrochloric Acid Concentrated		X	X	-	-	-	-	X	X	X	X	X	X
Hydrochloric Acid, 3 Molar		G	X	-	-	-	-	X	-	-	-	-	X
Hydrochloric Acid, 37%	E	X	-	X	E	G	X	X	X	X	X	X	X
Hydrocyanic Acid, 20% (Under 100°F)													
Hydrocyanic Acid, 98%	E	-	-	-	-	-	-	-	-	-	-	-	-
Hydro-Drive Oil			E	-	-	-	G	-	-	-	-	-	-
Hydro-Drive Oil Houghton			E	-	-	-	G	-	-	-	-	-	-
Hydrofluoric Acid, 10%		X	X	X	E	E	X	X	X	X	X	X	X
Hydrofluoric Acid, 20% (Under 120°F)		X	X	X	E	G	X	X	X	X	X	X	X
Hydrofluoric Acid, 48% (Under 120°F)		X	X	X	E	G	X	X	X	X	X	X	X
Hydrofluoric Acid, 70% (Permiabie)	E	-	X	X	-	G	X	X	X	X	X	X	X
Hydrofluoric Acid, Anhydrous			X	-	-	-	-	-	-	-	-	-	-
Hydrofluoric Acid, Concentrated	E	X	X	X	E	G	X	X	X	X	X	X	X
Hydrofluorosilic Acid	E												
Hydrogen ( Permiabie )	E	E	E	-	E	-	-	-	X	X	X	E	-
Hydrogen Chloride Gas (Permiabie)	E	-	-	-	E	-	-	-	-	E	E	-	-
Hydrogen Cyanide Gas (Permiabie - to 300°F)	E	-	-	-	-	-	-	-	-	-	-	E	-
Hydrogen Fluoride (Under 100°F)(Permiabie)	E	-	X	-	-	-	-	-	G	G	E	-	-
Hydrogen Perhydrol													
Hydrogen Peroxide, 10%	E	X	E	X	E	G	X	X	X	G	E	E	X
Hydrogen Peroxide, 30%	E	X	G	X	E	G	X	X	X	G	E	E	X
Hydrogen Peroxide, 70%	E	X	X	X	E	-	X	X	X	G	E	E	X

Underline is cover compound rating only. Many factors, such as temperature, concentration and length of exposure, are relevant to how chemical exposure affects the tube and cover or fitting material. The fluid manufacturers recommended maximum operating temperature should be carefully observed. Exceeding the manufacturer's recommended maximum temperature can result in fluid breakdown and cause harm or shorten life of tube and cover materials. There may be instances where the hose cover could be adversely affected by fluids which would not chemically affect the hose tube. Conversely, some fluids with an adverse affect on the tube of the hose may not have a deteriorating effect on the hose cover. It is recommended that the user test the hose/fluid compatibility to their own standards. Since no industry standards exist for chemical resistance, the Compass Chemical Resistance Guide for Elastomers is used whenever possible. Teflon® is a registered trademark of Dupont.

# Chemical Resistance Tables

The following is a representative list of fluids and manufacturers and a general guideline for the use and compatibility of Continental ContiTech hose and fittings.

## Rating Scale

E = Excellent resistance    X = Not recommended    Blank = No Data  
G = Good resistance    - = Testing recommended

Chemical Name	Hose								Fittings and Adapters				
	PTFE (Teflon®)	CR (Polychloropene)	NBR (Nitrile)	Nitrile/ PVC	CPE	CSM	Urethane	Nylon	Carbon Steel	Stainless Steel 304	Stainless Steel 316	Aluminum	Brass
Hydrogen Peroxide, 90%		X	X	-	-	-	-	-	X	G	E	-	X
Hydrogen Peroxide, Dilute		E	G	-	-	-	-	E	E	-	E	-	X
Hydrogen Sulfide, Aqueous Solution		G	X	-	-	-	-	-	X	-	-	X	-
Hydrogen Sulfide, Dry, Cold		E	E	-	-	-	-	E	-	-	-	G	X
Hydrogen Sulfide, Dry, Hot		G	X	-	-	-	-	E	E	X	G	G	X
Hydrogen Sulfide, Gas	E	-	-	-	-	-	-	-	-	-	-	-	-
Hydrogen Sulfide, Wet, Cold (Permeable)	E	E	X	-	-	-	-	E	G	G	G	G	X
Hydrogen Sulfide, Wet, Hot	E	G	X	-	-	-	-	E	G	G	E	-	X
Hydrofluosilicic Acid													
Hydrolube, Water Glycol	E	G	E	-	-	-	X	-	X	-	E	-	-
Hydrolubric Oil, Houghton		-	G	-	-	-	G	E	-	-	-	-	-
Hydroquinone	E	X	-	-	-	X	-	-	-	E	E	G	-
Hydroxy Quinoline													
Hykil N°6 (33%), Water (67%)	E	-	G	-	-	-	-	-	E	-	-	-	-
Hypochlorous Acid, (Under 120°F)		X	X	X	-	G	-	E	G	G	G	X	-
Hypoid Grease (Parapoid 10-C)		-	E	-	-	-	-	-	-	-	-	-	-
Imol, Imol S150, S220, S300, S500		-	E	-	-	-	G	E	E	E	E	E	-
Industron 53		-	E	-	-	-	-	-	-	-	-	-	-
Ink (Printers)	E	E	E	-	-	-	-	E	G	G	E	-	G
Ink Oil	E	-	G	-	-	-	-	-	E	E	E	-	E
Insulating Oil (Transformer)	E	G	E	G	-	X	-	-	E	E	E	-	E
Iodine (Under 100°F) (Gas- Permeable)	E	X	X	-	E	G	X	E	G	G	G	X	-
Iodine Pentafluoride		X	X	-	-	-	-	-	X	G	G	X	-
Iodine, in Alcohol	E	G	-	-	-	-	X	-	-	-	-	X	-
Irus Fluid 902		-	E	-	-	-	E	E	E	E	E	E	E
Irus Fluid 905		-	E	-	-	-	E	E	E	E	E	E	E
Isobutane		X	X	-	-	-	X	X	X	E	E	G	E
Isocyanates (at 70°F)													
Isooctane		E	E	G	G	E	G	-	E	E	E	G	E
Isooctyl Thioglucolate	E	-	-	-	-	-	-	-	-	-	-	-	-
Isopropyl Acetate	E	X	X	X	-	X	G	E	G	G	E	X	E
Isopropyl Alcohol (Isopropanol)	E	G	G	G	E	G	G	E	E	E	E	E	G
Isopropyl Ether	E												
Isopropylamine													

Underline is cover compound rating only. Many factors, such as temperature, concentration and length of exposure, are relevant to how chemical exposure affects the tube and cover or fitting material. The fluid manufacturers recommended maximum operating temperature should be carefully observed. Exceeding the manufacturer's recommended maximum temperature can result in fluid breakdown and cause harm or shorten life of tube and cover materials. There may be instances where the hose cover could be adversely affected by fluids which would not chemically affect the hose tube. Conversely, some fluids with an adverse affect on the tube of the hose may not have a deteriorating effect on the hose cover. It is recommended that the user test the hose/fluid compatibility to their own standards. Since no industry standards exist for chemical resistance, the Compass Chemical Resistance Guide for Elastomers is used whenever possible. Teflon® is a registered trademark of Dupont.

# Chemical Resistance Tables

The following is a representative list of fluids and manufacturers and a general guideline for the use and compatibility of Continental ContiTech hose and fittings.

### Rating Scale

E = Excellent resistance    X = Not recommended    Blank = No Data  
 G = Good resistance    - = Testing recommended

Chemical Name	Hose								Fittings and Adapters				
	PTFE (Teflon®)	CR (Polychloropene)	NBR (Nitrile)	Nitrile/PVC	CPE	CSM	Urethane	Nylon	Carbon Steel	Stainless Steel 304	Stainless Steel 316	Aluminum	Brass
Jet Fuel JP-3 (Under 100°F)	E	G	E	G	-	X	G	E	G	E	E	G	E
Jet Fuel JP-4	E	X	E	G	-	X	-	E	G	E	E	G	E
Jet Fuel JP-5	E	X	E	X	-	X	-	E	G	E	E	G	E
Jet Fuel JP-6	E	X	E	X	-	X	-	E	G	E	E	G	E
Jet Fuel JP-x (at 70°F)	E	G	E	X	-	X	-	E	G	E	E	G	E
Kerosene	E	X	E	G	E	X	-	E	E	E	E	E	E
Ketchup	E	E	E	-	-	-	-	E	-	E	E	-	-
Ketones	E	X	X	X	-	X	X	E	E	E	E	G	E
Keystone #87Hx-Grease+A334		X	E	-	-	-	-	-	E	E	E	E	-
Lacquer Solvents	E	X	X	X	-	X	G	E	X	G	E	E	E
Lacquers	E	X	X	X	-	X	-	E	X	X	E	E	E
Lactic Acid	E	E	X	X	-	E	X	-	X	G	E	X	G
Lactic Acid 10% Boiling	E	X	X	-	-	-	-	-	X	G	E	X	X
Lactic Acid 5%	E	G	E	-	-	-	-	E	X	G	E	E	X
Lactic Acid 5% Boiling	E	X	X	-	-	-	-	-	X	G	E	G	X
Lactol		G	G	G	-	-	-	-	E	E	E	E	E
Lasso (Ag Spray)		-	-	-	-	-	-	E	-	E	E	-	-
Latex	E	E	E	-	-	-	-	E	E	E	E	E	E
Lead Acetate	E	X	X	-	E	X	-	-	G	G	G	X	E
Lead Arsenate (to 70°F)	E	G	G	-	-	G	E	-	E	E	E	-	-
Lead Nitrate (to 300°F)	E	G	G	-	-	-	-	-	E	G	G	-	-
Lead Sulfate (to 300°F)	E	E	E	-	E	E	E	-	E	E	E	-	-
Lead Sulphamate (to 125°F)	E	G	G	-	-	G	-	-	-	-	-	-	-
Lead Tetramethyl	E	X	G	X	-	X	E	-	-	-	-	-	-
Lead, Tetraethyl (Under 100°F)	E	X	G	X	-	X	-	-	-	-	-	-	-
Lecithin	E	G	X	-	-	-	-	-	-	E	E	-	-
Ligroin (Petroleum Ether, Under 120°F)	E	X	E	-	-	X	-	-	G	E	E	X	-
Lime (Chlorinated Free Chlorine 20%)		-	E	-	E	-	E	-	-	-	G	-	-
Lime Bleach (Under 100°F)	-	X	G	X	-	X	-	-	X	G	E	-	-
Lime Sulphur		E	X	-	-	-	-	E	G	E	E	X	X
Lime Sulphur (Under 135°F)	E	E	X	X	-	G	-	E	G	E	E	X	X
Lindane (Ag Spray)		-	-	-	-	-	-	E	-	E	E	-	-
Lindol HF (to 200°F)	E												
Lindol, Hydraulic Fluid (to 200°F)	E	X	X	-	-	-	-	-	E	E	E	E	-
Linoleic Acid	E	X	G	X	-	-	-	-	X	G	E	E	-

Underline is cover compound rating only. Many factors, such as temperature, concentration and length of exposure, are relevant to how chemical exposure affects the tube and cover or fitting material. The fluid manufacturers recommended maximum operating temperature should be carefully observed. Exceeding the manufacturer's recommended maximum temperature can result in fluid breakdown and cause harm or shorten life of tube and cover materials. There may be instances where the hose cover could be adversely affected by fluids which would not chemically affect the hose tube. Conversely, some fluids with an adverse affect on the tube of the hose may not have a deteriorating effect on the hose cover. It is recommended that the user test the hose/fluid compatibility to their own standards. Since no industry standards exist for chemical resistance, the Compass Chemical Resistance Guide for Elastomers is used whenever possible. Teflon® is a registered trademark of Dupont.

# Chemical Resistance Tables

The following is a representative list of fluids and manufacturers and a general guideline for the use and compatibility of Continental ContiTech hose and fittings.

## Rating Scale

E = Excellent resistance    X = Not recommended    Blank = No Data  
G = Good resistance    - = Testing recommended

Chemical Name	Hose								Fittings and Adapters				
	PTFE (Teflon®)	CR (Polychloropene)	NBR (Nitrile)	Nitrile/PVC	CPE	CSM	Urethane	Nylon	Carbon Steel	Stainless Steel 304	Stainless Steel 316	Aluminum	Brass
Linseed Oil	E	X	E	-	-	-	-	E	E	E	E	G	G
Linseed Oil (Boiled)		G	G	E	E	E	E	-	G	E	E	E	G
LPG													
Lubricating Oil (Diester Under 135°F)		X	G	X	-	-	X	E	E	E	E	E	E
Lubricating Oil (Petroleum Base)	E	G	E	G	E	G	G	E	E	E	E	E	E
Lubricating Oil (SAE 10, 20, 30, 40, 50)	E	G	G	-	-	-	-	E	E	E	E	E	-
Machine Oil (Under 135°F)	E	E	E	G	-	G	G	-	E	E	E	E	E
Magnesium Carbonate	E	E	E	E	-	E	E	-	G	G	G	E	-
Magnesium Chloride	E	E	E	E	E	E	E	E	X	G	E	X	G
Magnesium Hydroxide	E	G	G	G	E	E	X	-	E	E	E	X	X
Magnesium Nitrate	E	G	G	G	-	E	-	-	G	G	G	X	E
Magnesium Sulfate	S	G	G	G	E	E	E	E	G	G	G	G	G
Malation (Ag Spray Dilute)		-	G	-	-	-	-	E	E	E	E	-	E
Maleic Acid	E	G	X	-	-	-	-	E	-	E	E	G	G
Manganese Salts (to 70°F)	E	-	E	E	-	E	-	-	-	-	-	-	-
Maximul (Penzoil Hydraulic Fluid)		G	E	G	-	-	-	-	E	-	E	-	-
Mercuric Chloride	E	E	G	G	E	E	G	X	X	G	G	X	X
Mercuric Cyanide	E	E	G	G	-	E	-	-	G	G	G	X	-
Mercurous Nitrate (Under 120°F)	E	E	G	G	-	E	-	-	E	E	E	X	-
Mercury	E	E	G	G	E	E	G	E	E	E	E	X	X
Mesityl Oxide	E	X	X	X	G	X	X	-	E	E	E	E	E
Methane (Gas or Liquid)	E	G	E	-	-	-	-	-	-	E	E	-	-
Methanol													
Methoxychlor (Insecticide)		-	-	-	-	-	-	X	E	E	E	-	-
Methyl Acetate	E	X	X	X	E	X	-	-	E	E	E	E	E
Methyl Acrylate	E	X	X	X	-	X	-	-	E	E	E	E	E
Methyl Alcohol, Methanol	E												
Methyl Amine (25% Aqueous Solution)	E	G	X	-	-	-	-	-	E	E	E	E	-
Methyl Amine (60%)		G	G	-	-	-	-	G	E	E	E	E	G
Methyl Amine (99%)		X	X	-	-	-	-	-	E	E	E	E	X
Methyl Amyl Carbinol	E	-	-	-	E	-	-	-	E	E	E	-	-
Methyl Bromide	E	X	X	X	-	X	X	X	E	E	E	X	E
Methyl Butyl Ketone (MBK)	E	X	X	X	G	X	-	-	E	E	E	E	E

Underline is cover compound rating only. Many factors, such as temperature, concentration and length of exposure, are relevant to how chemical exposure affects the tube and cover or fitting material. The fluid manufacturers recommended maximum operating temperature should be carefully observed. Exceeding the manufacturer's recommended maximum temperature can result in fluid breakdown and cause harm or shorten life of tube and cover materials. There may be instances where the hose cover could be adversely affected by fluids which would not chemically affect the hose tube. Conversely, some fluids with an adverse affect on the tube of the hose may not have a deteriorating effect on the hose cover. It is recommended that the user test the hose/fluid compatibility to their own standards. Since no industry standards exist for chemical resistance, the Compass Chemical Resistance Guide for Elastomers is used whenever possible. Teflon® is a registered trademark of Dupont.



# Chemical Resistance Tables

The following is a representative list of fluids and manufacturers and a general guideline for the use and compatibility of Continental ContiTech hose and fittings.

### Rating Scale

E = Excellent resistance    X = Not recommended    Blank = No Data  
 G = Good resistance    - = Testing recommended

Chemical Name	Hose								Fittings and Adapters				
	PTFE (Teflon®)	CR (Polychloropene)	NBR (Nitrile)	Nitrile/ PVC	CPE	CSM	Urethane	Nylon	Carbon Steel	Stainless Steel 304	Stainless Steel 316	Aluminum	Brass
Methyl Cellulosolve (Under 100°F)	E	G	X	-	E	X	-	-	G	G	G	G	E
Methyl Chloride		X	X	X	X	X	-	E	G	E	E	X	E
Methyl Ethyl Ketone (MEK)	E	X	X	X	G	X	X	E	E	E	E	G	E
Methyl Formate	E	G	X	X	-	X	-	-	G	E	E	E	E
Methyl Isobutyl Ketone (MIBK, 100°F)	E	X	X	X	G	X	X	G	G	G	G	G	E
Methyl Isopropyl Ketone	E	X	X	X	G	X	X	-	G	E	E	E	E
Methyl Methacrylate	E	X	X	X	G	G	-	-	G	G	G	-	-
Methyl Methyl Ketone													
Methyl Salicylate	E	G	G	G	-	-	-	-	E	E	E	E	E
Methyl Sulfate													
(Dinethyl, Under 100°F)	E	X	X	X	-	X	E	-	-	-	-	-	-
Methylene Chloride	E	X	X	X	X	X	-	G	G	G	G	X	E
Methylene Dichloride	E	X	X	X	-	-	-	E	E	E	E	X	E
Methylhalides													
MIL-F-7083													
MIL-H 5606													
MIL-H-83282													
MIL-L-2104 & 2104B													
MIL-L-7808													
MIL-O-6083													
Mine Guard FR													
Mineral Oil (Under 120°F)													
Mineral Spirit		-	E	G	-	X	-	-	E	E	E	G	E
MLO-8220 Hydro		E	G	-	-	-	-	-	E	E	E	E	-
MLO-7277 Hydro,		X	X	-	-	-	-	-	E	E	E	E	-
MLO-7557		E	X	-	-	-	-	-	E	E	E	E	-
MLO-8515		E	G	-	-	-	-	E	E	E	E	E	-
Mobil DTE													
Mobil HFA													
Mobil Rarus 824, 826, 827													
Mobil SHC 600 Series													
Mobil SHC 800 Series													
Mobil Vectra Oil													
Mobile Hydraulic Oils		-	E	-	-	-	G	-	E	E	E	E	-
Mobile Therm 603		-	E	-	-	-	-	-	E	E	E	E	E
Mobilfluid 423													
Mobilmet S122		-	E	-	-	-	G	-	-	-	-	-	-

Underline is cover compound rating only. Many factors, such as temperature, concentration and length of exposure, are relevant to how chemical exposure affects the tube and cover or fitting material. The fluid manufacturers recommended maximum operating temperature should be carefully observed. Exceeding the manufacturer's recommended maximum temperature can result in fluid breakdown and cause harm or shorten life of tube and cover materials. There may be instances where the hose cover could be adversely affected by fluids which would not chemically affect the hose tube. Conversely, some fluids with an adverse affect on the tube of the hose may not have a deteriorating effect on the hose cover. It is recommended that the user test the hose/fluid compatibility to their own standards. Since no industry standards exist for chemical resistance, the Compass Chemical Resistance Guide for Elastomers is used whenever possible. Teflon® is a registered trademark of DuPont.

## Chemical Resistance Tables

The following is a representative list of fluids and manufacturers and a general guideline for the use and compatibility of Continental ContiTech hose and fittings.

### Rating Scale

E = Excellent resistance    X = Not recommended    Blank = No Data  
G = Good resistance    - = Testing recommended

Chemical Name	Hose								Fittings and Adapters				
	PTFE (Teflon®)	CR (Polychloropene)	NBR (Nitrile)	Nitrile/ PVC	CPE	CSM	Urethane	Nylon	Carbon Steel	Stainless Steel 304	Stainless Steel 316	Aluminum	Brass
Mobilrama 525													
Molasses (Under 120°F)	E	G	G	G	-	E	E	-	G	E	E	G	X
Monochlorobenzene													
(Permiable)	E	X	X	X	X	X	X	X	E	E	E	X	E
Monoethanolamine	E	X	G	-	E	X	-	-	E	E	E	G	E
Morpholine (Pure Additive)	E												
Motor Oils (Under 135°F)	E	G	E	G	E	G	G	E	E	E	E	E	E
Mould Oil		-	-	-	-	-	-	-	E	E	E	-	-
Muriatic Acid (Permiable)	E	X	X	X	E	G	X	X	X	X	X	X	X
Mustard	E	E	G	E	-	E	-	-	X	E	E	G	-
NaK													
Naphtenic Acid	E												
Naphtha (Low													
Aromatic Content)	E	X	G	X	E	X	-	E	G	E	E	E	E
Naphthalene	E	X	X	X	-	X	-	-	E	E	E	-	E
Naphthalene (Tar Camphor)	E	X	X	X	E	X	-	E	E	E	E	E	E
Natural Gas	E												
Neon Gas	E												
N-Hexaldehyde	E	G	X	G	-	-	-	-	E	E	E	E	E
Nickel Acetate	E	G	G	-	-	-	-	-	E	G	G	E	E
Nickel Chloride	E	G	G	G	E	G	-	E	X	G	G	X	X
Nickel Nitrate	E	G	G	G	E	G	-	E	G	G	G	X	-
Nickel Plating Solution		-	G	-	-	G	X	-	-	E	E	-	-
Nickel Salts	E	G	-	E	-	-	-	-	-	-	-	-	-
Nickel Sulfate	E												
Nicotine Salts	E	-	-	-	-	-	E	-	E	X	G	-	-
Nitric Acid	E	X	X	-	-	-	-	-	X	E	E	-	X
Nitric Acid &													
Hydrochloric Acid		-	X	-	-	-	-	-	X	X	X	X	-
Nitric Acid, 20%	E	X	X	X	E	G	X	X	X	G	G	X	X
Nitric Acid, 3 M		X	X	-	-	-	-	-	X	E	E	-	X
Nitric Acid, 5% to 10%	E	X	X	X	E	G	X	X	X	G	G	E	X
Nitric Acid, 50% (Boiling)		X	X	X	X	X	X	X	X	G	G	X	X
Nitric Acid, 65% (Boiling)		X	X	X	X	X	X	X	X	G	G	X	X
Nitric Acid, Concentrated													
(Boiling)		X	X	-	-	-	-	X	X	G	G	X	X
Nitric Acid, Inhibited RED													
fuming (IRFNA)		X	X	-	-	-	-	-	X	E	E	E	X
Nitric Acid, Red Fuming													
(RNFA)	E	X	X	X	-	X	X	X	X	G	G	G	X

Underline is cover compound rating only. Many factors, such as temperature, concentration and length of exposure, are relevant to how chemical exposure affects the tube and cover or fitting material. The fluid manufacturers recommended maximum operating temperature should be carefully observed. Exceeding the manufacturer's recommended maximum temperature can result in fluid breakdown and cause harm or shorten life of tube and cover materials. There may be instances where the hose cover could be adversely affected by fluids which would not chemically affect the hose tube. Conversely, some fluids with an adverse affect on the tube of the hose may not have a deteriorating effect on the hose cover. It is recommended that the user test the hose/fluid compatibility to their own standards. Since no industry standards exist for chemical resistance, the Compass Chemical Resistance Guide for Elastomers is used whenever possible. Teflon® is a registered trademark of Dupont.

# Chemical Resistance Tables

The following is a representative list of fluids and manufacturers and a general guideline for the use and compatibility of Continental ContiTech hose and fittings.

### Rating Scale

E = Excellent resistance    X = Not recommended    Blank = No Data  
 G = Good resistance    - = Testing recommended

Chemical Name	Hose								Fittings and Adapters				
	PTFE (Teflon®)	CR (Polychloropene)	NBR (Nitrile)	Nitrile/PVC	CPE	CSM	Urethane	Nylon	Carbon Steel	Stainless Steel 304	Stainless Steel 316	Aluminum	Brass
Nitrobenzene (Under 100°F)	E	X	X	X	G	X	X	-	G	G	G	G	E
Nitroethane	E	X	X	X	E	G	-	-	E	E	E	E	E
Nitrogen	E	E	E	G	E	E	E	E	E	E	E	E	E
Nitrogen Fertilizer Solution													
Nitrogen Oxide up to 50% (Under 100°F)		E	E	G	E	E	-	E	E	E	E	-	X
Nitromethane (Permiabile)	E	X	X	X	-	-	-	E	E	E	E	E	E
Nitropropane		X	X	X	-	-	-	E	E	E	E	E	E
Nitrous Oxide (Gas)	E												
N-Octane		X	G	-	E	X	-	-	E	E	E	-	E
Nuto H													
Nyvac 20 (WG), 30 (WG)		-	E	-	-	-	-	-	E	E	E	E	E
Nyvac FR Fluid		-	E	-	-	-	-	-	E	E	E	E	E
Nyvac FR200 Fluid		-	E	-	-	-	-	-	E	E	E	E	E
O-148 (NATO)													
Octyl Alcohol	E												
Oil (SAE, Under 100°F)	E	E	E	E	E	G	E	E	E	E	E	E	E
Oil Synthetic Blends													
Oils Crude	E	X	G	-	-	-	-	-	-	E	E	-	-
Oleic Acid (Under 120°F)	E	G	G	G	E	G	E	E	G	G	E	E	G
Oleum 25%													
Oleum Spirits ( to 70°F)	E												
Olive Oil	E	X	G	G	G	X	-	-	G	E	E	E	G
Orthodichlorobenzene													
OS 45 Type III (OS45)	E	E	G	-	-	-	-	-	-	-	-	-	-
OS 45 Type IV (OS45-1)	E	E	G	-	-	-	-	-	-	-	-	-	-
OS 70		E	G	-	-	-	-	-	-	-	-	-	-
Oxalic Acid (5%, Hot and Cold)		G	G	-	-	-	-	G	X	G	E	E	X
Oxalic Acid	E	X	X	X	E	G	X	X	X	G	E	G	X
Oxalic Acid (10% Boiling)		X	X	-	-	-	-	-	X	X	X	X	X
Oxalic Acid (10%)		G	G	-	-	-	-	G	X	G	E	E	X
Oxygen (200°-400°F)		X	X	-	-	-	-	-	-	-	-	-	-
Oxygen Cold		E	G	-	E	-	-	E	G	E	E	E	E
Oxygen Gaseous	E	-	-	-	-	-	-	-	-	-	-	E	-
Ozone (Dry)	E	G	X	G	E	G	E	G	E	E	E	E	E
Ozone (Wet)	E	-	X	-	-	-	-	-	X	G	E	G	-
Pacemaker Types 150T, 300T, 500T (Citgo)		-	E	-	-	-	-	-	-	-	-	-	-
Paint	E	X	-	-	-	X	X	G	-	E	E	E	E

Underline is cover compound rating only. Many factors, such as temperature, concentration and length of exposure, are relevant to how chemical exposure affects the tube and cover or fitting material. The fluid manufacturers recommended maximum operating temperature should be carefully observed. Exceeding the manufacturer's recommended maximum temperature can result in fluid breakdown and cause harm or shorten life of tube and cover materials. There may be instances where the hose cover could be adversely affected by fluids which would not chemically affect the hose tube. Conversely, some fluids with an adverse affect on the tube of the hose may not have a deteriorating effect on the hose cover. It is recommended that the user test the hose/fluid compatibility to their own standards. Since no industry standards exist for chemical resistance, the Compass Chemical Resistance Guide for Elastomers is used whenever possible. Teflon® is a registered trademark of Dupont.

# Chemical Resistance Tables

The following is a representative list of fluids and manufacturers and a general guideline for the use and compatibility of Continental ContiTech hose and fittings.

## Rating Scale

E = Excellent resistance    X = Not recommended    Blank = No Data  
G = Good resistance    - = Testing recommended

Chemical Name	Hose								Fittings and Adapters				
	PTFE (Teflon®)	CR (Polychloropene)	NBR (Nitrile)	Nitrile/PVC	CPE	CSM	Urethane	Nylon	Carbon Steel	Stainless Steel 304	Stainless Steel 316	Aluminum	Brass
Paint Solvents (Oil Base)		X	X	-	-	X	X	G	-	E	E	E	E
Paint Thinner, Duco	E	G	E	-	-	-	-	E	G	G	E	G	X
Paints (Oil Base)	E	-	E	-	-	E	-	E	-	-	-	-	-
Palm Oil	E	G	E	G	-	G	-	-	E	E	E	E	E
Palmitic Acid	E	G	G	G	E	X	E	E	G	G	E	E	X
Paradichlorobenzene													
Paraffin (Petroleum)		G	E	G	E	X	-	E	G	E	E	E	E
Paraformaldehyde	E	G	G	G	-	G	G	-	E	E	E	E	-
Peanut Oil (Under 100°F)	E	G	E	G	-	-	-	-	E	E	E	E	E
Pentane ( Gas or Liquid )	E												
Pentasol		G	G	G	-	G	-	-	E	E	E	E	E
Perchloric Acid	E	X	X	-	-	G	X	X	X	G	E	X	-
Perchloroethylene													
(Tetrachloroethylene)	E	X	X	X	G	X	-	G	E	E	E	X	X
Petroleum Oil (Above 250°F)	E	X	X	-	-	-	-	-	-	-	-	-	-
Petroleum Oil (Crude)	E	G	E	-	-	-	-	-	-	-	-	-	-
Petroleum Oil (Under 250°F)		G	E	-	-	-	-	-	-	-	-	-	-
Petroleum Oils (Refined)		G	E	G	-	G	G	E	E	E	E	E	E
Petroleum Oils (Sour)	E	G	G	-	-	X	G	-	G	E	E	E	X
Petroleum Oils (Under 100°F)		G	E	G	-	G	G	-	E	E	E	E	E
Phenol (70/30 Water)		X	X	-	-	-	-	-	-	E	E	E	-
Phenol (85/15 Water)		X	X	-	-	-	-	-	-	E	E	E	-
Phenol (Carbolic Acid)	E	X	X	X	E	X	X	X	G	E	E	E	X
Phenylamine													
Phorone													
(Diisopropylidene Acetone)	E	X	X	-	-	X	X	-	E	E	E	-	E
Phosphate Esters (3 Molar)		X	X	-	G	G	X	G	-	-	-	-	-
Phosphate Esters (Concentrated)	E	X	X	-	X	X	X	G	-	-	-	-	-
Phosphate Esters (Dilute)	E	X	X	-	E	E	X	G	-	-	-	-	-
Phosphoric Acid	E	G	G	-	-	-	-	-	-	-	G	-	-
Phosphoric Acid (1%)		G	-	-	-	-	-	-	-	E	E	-	X
Phosphoric Acid (10% Hot)		G	X	-	-	-	-	-	X	-	E	X	X
Phosphoric Acid (10%)		G	X	-	-	-	-	-	X	-	E	X	X
Phosphoric Acid (3 Molar)		X	X	-	-	-	-	-	-	-	-	-	-
Phosphoric Acid (5%)		G	X	-	-	-	-	-	-	E	E	-	X
Phosphoric Acid (50% Hot)		G	X	-	-	-	-	-	X	X	G	X	X
Phosphoric Acid (50%)		G	G	G	E	E	X	X	X	G	E	X	G
Phosphoric Acid (85% Hot)		G	X	-	-	-	-	-	X	X	X	X	X

Underline is cover compound rating only. Many factors, such as temperature, concentration and length of exposure, are relevant to how chemical exposure affects the tube and cover or fitting material. The fluid manufacturers recommended maximum operating temperature should be carefully observed. Exceeding the manufacturer's recommended maximum temperature can result in fluid breakdown and cause harm or shorten life of tube and cover materials. There may be instances where the hose cover could be adversely affected by fluids which would not chemically affect the hose tube. Conversely, some fluids with an adverse affect on the tube of the hose may not have a deteriorating effect on the hose cover. It is recommended that the user test the hose/fluid compatibility to their own standards. Since no industry standards exist for chemical resistance, the Compass Chemical Resistance Guide for Elastomers is used whenever possible. Teflon® is a registered trademark of Dupont.

# Chemical Resistance Tables

The following is a representative list of fluids and manufacturers and a general guideline for the use and compatibility of Continental ContiTech hose and fittings.

### Rating Scale

**E** = Excellent resistance    **X** = Not recommended    **Blank** = No Data  
**G** = Good resistance    **-** = Testing recommended

Chemical Name	Hose								Fittings and Adapters				
	PTFE (Teflon®)	CR (Polychloropene)	NBR (Nitrile)	Nitrile/PVC	CPE	CSM	Urethane	Nylon	Carbon Steel	Stainless Steel 304	Stainless Steel 316	Aluminum	Brass
Phosphoric Acid (85%)		G	X	-	E	E	X	X	X	G	G	X	X
Phosphoric Acid (Aerated)		-	-	-	-	-	-	-	X	-	G	-	-
Phosphoric Acid (Concentrated)	E	X	X	-	-	-	-	-	-	-	-	-	-
Phosphoric Acid Air Free		-	-	-	-	-	-	-	X	-	-	X	-
Phosphorous Trichlor	E												
Photographic Developers	E	E	E	-	-	-	-	-	X	E	E	-	-
Photographic, Emulsions	E	-	-	-	-	-	-	-	-	-	-	-	-
Photographic, Fixing Solutions	E	G	-	-	-	G	-	-	-	E	E	-	-
Phthalic Acid		-	-	-	-	-	-	-	G	G	E	G	-
Picric Acid (Water Solution 100°F)	E	G	G	G	-	G	G	X	X	E	E	X	X
Picric Acid Molten													
Pine Oil	E	X	G	-	G	X	-	E	E	E	E	E	-
Pinene	E	X	G	-	G	-	-	-	E	E	E	E	E
Piperazine Hydrochloride Solution (34%)		-	G	-	-	-	-	-	-	-	-	-	-
Pitch		G	E	-	-	G	G	E	-	-	-	-	-
Plating Solutions (Chrome)	E	X	X	-	-	-	X	X	-	X	X	-	-
Plating Solutions (Other)	E	-	E	-	-	-	-	-	-	-	-	-	-
Polyester Resin		-	-	-	-	-	-	G	-	-	-	-	-
Polyol Ester													
Polyurethane Foam (Under 125°F)		-	-	-	-	-	-	-	-	-	-	-	-
Potassium Acetate	E	G	G	-	E	G	X	-	G	E	E	X	-
Potassium Bicarbonate	E	E	E	-	-	E	-	E	E	G	G	E	-
Potassium Bisulfite	E	-	E	-	-	-	-	E	-	-	-	-	-
Potassium Bromate	E	-	-	-	-	-	-	-	-	-	-	-	-
Potassium Bromide	E	E	E	-	-	E	G	E	X	X	G	X	-
Potassium Carbonate (Potash)	E	E	E	E	E	E	G	E	G	E	E	X	X
Potassium Chlorate	E	E	E	-	-	-	G	E	G	G	G	G	-
Potassium Chloride (1% to 5%)	E	E	E	-	E	-	G	E	E	G	G	X	X
Potassium Chloride (Boiling)		-	-	-	-	-	-	-	-	G	G	-	X
Potassium Cyanide	E	E	E	-	E	-	-	E	G	G	G	X	X
Potassium Dichromate	E	E	E	-	E	-	-	G	E	G	G	G	-
Potassium Ferrocyanide	E	-	-	-	-	-	-	-	G	E	E	G	-
Potassium Fluoride	E	-	-	-	-	-	-	-	-	-	-	-	-

Underline is cover compound rating only. Many factors, such as temperature, concentration and length of exposure, are relevant to how chemical exposure affects the tube and cover or fitting material. The fluid manufacturers recommended maximum operating temperature should be carefully observed. Exceeding the manufacturer's recommended maximum temperature can result in fluid breakdown and cause harm or shorten life of tube and cover materials. There may be instances where the hose cover could be adversely affected by fluids which would not chemically affect the hose tube. Conversely, some fluids with an adverse affect on the tube of the hose may not have a deteriorating effect on the hose cover. It is recommended that the user test the hose/fluid compatibility to their own standards. Since no industry standards exist for chemical resistance, the Compass Chemical Resistance Guide for Elastomers is used whenever possible. Teflon® is a registered trademark of Dupont.

# Chemical Resistance Tables

The following is a representative list of fluids and manufacturers and a general guideline for the use and compatibility of Continental ContiTech hose and fittings.

## Rating Scale

E = Excellent resistance    X = Not recommended    Blank = No Data  
G = Good resistance    - = Testing recommended

Chemical Name	Hose								Fittings and Adapters				
	PTFE (Teflon®)	CR (Polychloropene)	NBR (Nitrile)	Nitrile/PVC	CPE	CSM	Urethane	Nylon	Carbon Steel	Stainless Steel 304	Stainless Steel 316	Aluminum	Brass
Potassium Fluoride	E	-	-	-	-	-	-	-	-	-	-	-	-
Potassium Hydroxide	E	G	G	-	-	-	-	-	E	E	E	-	-
Potassium Hydroxide (27%Boiling)	-	-	-	-	-	-	-	-	G	G	E	X	X
Potassium Hydroxide (5%)	-	E	E	-	-	-	-	E	G	G	G	X	X
Potassium Hydroxide (50% Boiling)	-	-	-	-	-	-	-	-	G	G	G	X	X
Potassium Hydroxide (70% Hot)	-	-	-	-	-	-	-	-	X	-	-	X	X
Potassium Hydroxide (70%)	-	-	E	-	-	-	-	-	-	-	-	X	X
Potassium Hydroxide (30% Caustic Potash)	-	-	-	-	E	-	-	-	-	-	-	-	-
Potassium Iodide	-	E	E	-	-	E	-	E	E	G	G	-	-
Potassium Nitrate	E	E	E	-	E	-	E	E	E	E	G	G	G
Potassium Nitrate (1% to 5%)	-	E	E	-	-	-	-	-	E	E	E	E	G
Potassium Permanganate	E	E	G	-	-	-	-	G	E	G	G	G	-
Potassium Permanganate (5%)	-	E	E	-	-	-	-	E	E	E	E	E	-
Potassium Persulfate	E	-	-	-	-	-	-	-	-	-	-	-	-
Potassium Phosphate	E	E	-	-	-	E	-	-	X	G	G	X	-
Potassium Sulfate	E	E	E	-	E	-	E	E	E	G	G	E	-
Potassium Sulfate 1% & 5%	-	E	E	-	-	-	-	E	E	E	E	E	X
Potassium Sulfide	-	E	E	-	-	-	-	-	G	G	G	-	-
Potassium Sulfite ( to 300°F)	E	E	E	-	E	-	-	-	E	E	E	E	-
Potassium Thiosulfate	E	E	-	-	-	E	-	-	-	-	-	-	-
Primatol A, S, P (Ag Spray)	-	-	-	-	-	-	-	-	-	-	-	-	-
PRL-High Temp Hydraulic Oil	-	G	E	-	-	-	-	-	E	E	E	E	-
Propane Gas	E	X	X	-	-	-	X	X	X	E	E	E	-
Propionic Acid	E	X	X	-	-	-	-	-	E	-	G	G	-
Propyl Acetate	E	X	X	-	G	-	-	-	E	-	-	-	-
Propylene (Liquid or Gas, Ambient)	E	X	X	-	E	-	-	G	E	E	E	E	-
Propylene Dichloride	E	-	-	-	-	-	-	-	E	G	E	X	-
Propylene Glycol	-	E	X	-	E	E	E	G	E	G	G	E	-
Propylene Oxide ( Permiabie )	E	X	X	-	-	-	-	-	G	E	E	G	-
Purina Insecticide	-	X	X	-	-	-	-	G	E	E	E	E	G
Puropale RX Oils	-	-	E	-	-	-	G	E	E	E	E	E	E
Pydraulic	-	X	X	-	-	-	-	-	-	-	-	-	-
Pydraulic 10E,29E-LT,30E,60,65E,115E	-	X	X	-	G	-	-	-	E	E	E	E	E
Pydraulic 135 ( to 70°F)	E	-	X	-	G	-	-	G	E	E	E	-	-

Underline is cover compound rating only. Many factors, such as temperature, concentration and length of exposure, are relevant to how chemical exposure affects the tube and cover or fitting material. The fluid manufacturers recommended maximum operating temperature should be carefully observed. Exceeding the manufacturer's recommended maximum temperature can result in fluid breakdown and cause harm or shorten life of tube and cover materials. There may be instances where the hose cover could be adversely affected by fluids which would not chemically affect the hose tube. Conversely, some fluids with an adverse affect on the tube of the hose may not have a deteriorating effect on the hose cover. It is recommended that the user test the hose/fluid compatibility to their own standards. Since no industry standards exist for chemical resistance, the Compass Chemical Resistance Guide for Elastomers is used whenever possible. Teflon® is a registered trademark of Dupont.

# Chemical Resistance Tables

The following is a representative list of fluids and manufacturers and a general guideline for the use and compatibility of Continental ContiTech hose and fittings.

### Rating Scale

E = Excellent resistance    X = Not recommended    Blank = No Data  
 G = Good resistance    - = Testing recommended

Chemical Name	Hose								Fittings and Adapters				
	PTFE (Teflon®)	CR (Polychloropene)	NBR (Nitrile)	Nitrile/PVC	CPE	CSM	Urethane	Nylon	Carbon Steel	Stainless Steel 304	Stainless Steel 316	Aluminum	Brass
Pydraulic 150		X	X	X	G	X	G	G	E	E	E	E	E
Pydraulic 280 (at 400°F)	G	X	X	X	G	X	G	G	E	E	E	-	-
Pydraulic 312 (to 70°F)	E	X	X	X	G	-	G	E	E	E	E	-	-
Pydraulic 50E		-	-	-	G	-	G	E	E	E	E	-	-
Pydraulic 540 (to 70°F)	E	X	X	X	G	X	X	X	E	E	E	-	-
Pydraulic 625		X	X	X	G	X	G	G	E	E	E	-	-
Pydraulic A-200		X	X	X	G	X	X	G	E	E	E	-	-
Pydraulic F-9		X	X	X	G	X	G	E	E	E	E	-	-
Pyranol, Transformer Oil (to 70°F)	E	G	E	-	-	-	-	-	E	E	E	E	-
Pyridine	E	X	X	-	-	X	E	-	E	E	E	E	E
Pyrogard 160, 230, 630		-	-	-	-	-	-	-	E	E	E	-	-
Pyrogard 51, 53, 55		-	X	-	-	-	-	-	E	E	E	-	-
Pyrogard C, D	E	-	E	-	-	-	G	E	E	E	E	E	E
Pyrolube		E	X	-	-	-	-	-	-	-	-	-	-
Quench Oil	E	G	G	-	-	-	-	-	-	E	E	E	-
Quintolubric 700													
Quintolubric 822		X	E	-	-	-	-	-	E	E	E	E	E
Quintolubric 957, 958													
Ramrod (Ag Spray)		-	-	-	-	-	-	E	E	E	E	E	E
Rando Oils		-	E	-	-	-	G	E	E	E	E	E	E
Rape Seed Oil		G	X	-	-	X	-	G	E	E	E	E	E
Red Line 100 Oil	E	G	E	-	-	-	-	-	-	-	-	-	-
Red Oil (Comm. Oleic Acid, MIL-H-5606)	E	G	G	G	E	G	-	E	G	G	E	E	G
Refined Wax (Petroleum)		G	E	G	-	-	G	E	E	E	E	-	E
Refrigerant Freon 113 (see Freon)	Use Freon Hose Only												
Refrigerant Freon 114 (see Freon)	Use Freon Hose Only												
Refrigerant Freon 12 (see Freon)	Use Freon Hose Only												
Refrigerant Freon 22 (see Freon)	Use Freon Hose Only												
Refrigerant Freon 502 (see Freon)	Use Freon Hose Only												
Refrigerant HFC 134A (see Freon)	Use Freon Hose Only												
Regal Oils R&O		-	E	-	-	-	G	E	-	-	-	-	-
Resorcinol													

Underline is cover compound rating only. Many factors, such as temperature, concentration and length of exposure, are relevant to how chemical exposure affects the tube and cover or fitting material. The fluid manufacturers recommended maximum operating temperature should be carefully observed. Exceeding the manufacturer's recommended maximum temperature can result in fluid breakdown and cause harm or shorten life of tube and cover materials. There may be instances where the hose cover could be adversely affected by fluids which would not chemically affect the hose tube. Conversely, some fluids with an adverse affect on the tube of the hose may not have a deteriorating effect on the hose cover. It is recommended that the user test the hose/fluid compatibility to their own standards. Since no industry standards exist for chemical resistance, the Compass Chemical Resistance Guide for Elastomers is used whenever possible. Teflon® is a registered trademark of Dupont.

# Chemical Resistance Tables

The following is a representative list of fluids and manufacturers and a general guideline for the use and compatibility of Continental ContiTech hose and fittings.

### Rating Scale

E = Excellent resistance    X = Not recommended    Blank = No Data  
 G = Good resistance    - = Testing recommended

Chemical Name	Hose								Fittings and Adapters				
	PTFE (Teflon®)	CR (Polychloropene)	NBR (Nitrile)	Nitrile/PVC	CPE	CSM	Urethane	Nylon	Carbon Steel	Stainless Steel 304	Stainless Steel 316	Aluminum	Brass
Richfield Weed Killer		X	G	-	-	X	-	-	-	-	-	-	-
Round Up		G	G	-	-	-	-	E	G	E	E	E	E
Rubilene Oils		-	E	-	-	-	G	E	-	-	-	-	-
SAE N° 10 Oil	E												
Safco-Safe T10, T20													
Safetytex 215		-	X	-	-	-	-	-	-	-	-	-	-
Salicylic Acid (to 400°F)	E	E	X	-	-	-	-	E	E	E	E	G	-
Salt Water (See Water)	E	G	G	G	-	G	E	E	G	E	E	X	G
Santo Safe 300		X	X	-	-	-	-	-	E	E	E	E	-
Santosafe W-G15, W-G20, W-G30		-	E	-	-	-	G	E	E	E	E	E	E
SCC 7204 (Stauffer)		-	-	-	-	-	-	-	-	-	-	-	-
Sevin		-	-	-	-	-	-	E	-	-	-	-	-
Sewage	E	G	G	G	E	G	-	E	X	E	E	G	G
Shell IRUS 902	E												
Shell IRUS 905	E												
Shell Pella-A													
Shell Tellus													
Shellac (to 400°F)		G	E	-	-	-	-	E	E	E	E	E	-
Shellac (Bleached) (to 400°F)	E	G	E	-	-	-	-	E	E	E	E	E	G
Shellac (Orange) (to 400°F)	E	G	E	-	-	-	-	E	E	E	E	E	G
Silicate Ester (to 400°F)	E												
Silicone Greases	E	G	G	G	-	G	-	E	E	E	E	E	E
Silicone Oils	E	G	G	G	-	G	-	E	E	E	E	E	E
Silver Cyanide	E	E	-	-	-	-	-	-	E	E	E	X	-
Silver Nitrate	E	E	E	E	E	E	-	E	G	E	E	E	G
Skelly, Solvent B, C, E		X	E	-	-	-	-	-	-	-	-	-	-
Skydrol 500A & 7000 (to 200°F)	E	X	X	X	G	X	-	E	E	E	E	E	-
Soap oil	E	X	X	-	-	X	-	-	E	E	E	-	-
Soap Solutions	E	G	E	G	E	E	E	E	E	E	E	E	E
Soda Ash (Sodium Carbonate)	E	E	E	E	E	E	E	E	E	E	E	X	G
Soda Water	E	-	-	-	-	-	E	E	-	-	-	-	-
Sodium Dichromate		G	E	-	E	G	E	E	-	-	-	-	-
Sodium Hypochlorite - 100% (to 200°F)	E	E	X	-	-	-	-	-	X	X	X	X	-
Sodium Hypochlorite 20% (to 400°F)	E	X	X	X	E	E	X	E	X	X	G	X	X
Sodium Hypochlorite 5%	E	-	X	X	E	E	X	E	X	X	G	X	X
Sodium Hyposulfate	E	X	-	-	-	-	-	-	X	E	E	X	-

Underline is cover compound rating only. Many factors, such as temperature, concentration and length of exposure, are relevant to how chemical exposure affects the tube and cover or fitting material. The fluid manufacturers recommended maximum operating temperature should be carefully observed. Exceeding the manufacturer's recommended maximum temperature can result in fluid breakdown and cause harm or shorten life of tube and cover materials. There may be instances where the hose cover could be adversely affected by fluids which would not chemically affect the hose tube. Conversely, some fluids with an adverse affect on the tube of the hose may not have a deteriorating effect on the hose cover. It is recommended that the user test the hose/fluid compatibility to their own standards. Since no industry standards exist for chemical resistance, the Compass Chemical Resistance Guide for Elastomers is used whenever possible. Teflon® is a registered trademark of Dupont.



# Chemical Resistance Tables

The following is a representative list of fluids and manufacturers and a general guideline for the use and compatibility of Continental ContiTech hose and fittings.

### Rating Scale

E = Excellent resistance    X = Not recommended    Blank = No Data  
 G = Good resistance    - = Testing recommended

Chemical Name	Hose								Fittings and Adapters				
	PTFE (Teflon®)	CR (Polychloropene)	NBR (Nitrile)	Nitrile/PVC	CPE	CSM	Urethane	Nylon	Carbon Steel	Stainless Steel 304	Stainless Steel 316	Aluminum	Brass
Sodium Metaphosphate	E	G	G	G	E	G	-	E	X	E	E	E	X
Sodium Nitrate	E	X	X	-	E	G	E	E	E	G	G	G	G
Sodium Perborate	E	X	X	-	-	X	-	G	X	E	E	E	X
Sodium Peroxide (Sodium Dioxide)	E	E	G	E	G	E	-	X	X	E	E	E	X
Sodium Phosphate	E	X	E	-	E	-	E	E	G	E	E	X	X
Sodium Phosphate (Dibasic)	E	G	E	-	-	-	-	-	-	-	-	-	-
Sodium Phosphate (Mono)	E	E	E	-	-	-	-	-	-	-	-	-	-
Sodium Phosphate (Tribasic)		G	E	-	-	-	-	-	G	G	G	-	-
Sodium Silicate		E	E	-	E	E	G	E	G	G	G	X	X
Sodium Silicate (Hot)	E	E	E	-	-	-	-	-	G	G	G	X	X
Sodium Sulfate	E	E	E	-	E	E	E	E	G	E	E	-	G
Sodium Sulfide	E	E	E	-	E	E	E	E	X	X	G	X	X
Sodium Sulfide Saturated - 100%	E	E	E	-	-	-	-	E	G	G	E	X	X
Sodium Sulfite		G	G	G	E	G	E	G	E	E	E	-	X
Sodium Sulfite 10% @ 150°F		E	E	-	-	-	-	-	G	G	G	G	-
Sodium Sulfite 5%		E	E	-	-	-	-	-	E	E	E	E	-
Sodium Thiosulfate (hpo, Antichlor)	E	E	E	E	E	E	E	E	X	E	E	G	X
Sodium Tripolyphosphate (STPP) (to 70°F)	E	-	-	-	-	-	-	-	-	E	E	X	X
Sodium Acetate	E	X	X	X	E	X	G	E	E	E	E	E	E
Sodium Benzoate	E	-	-	-	-	-	E	-	-	-	-	-	-
Sodium Bicarbonate	E	E	E	E	E	E	E	E	G	E	E	G	G
Sodium Bisulfate (Niter Cake)		E	E	E	E	E	E	E	X	G	E	X	X
Sodium Bisulfite	E	E	E	E	E	E	E	E	G	E	E	G	-
Sodium Borate	E	E	E	E	E	E	E	E	E	E	E	-	-
Sodium Carbonate	E	E	E	E	E	E	E	E	G	G	G	X	G
Sodium Chlorate	E	G	E	-	E	E	E	E	G	G	G	X	-
Sodium Chloride	E	E	E	E	E	E	E	E	G	G	E	X	X
Sodium Chloride - 2%	E	E	E	-	-	-	-	E	G	G	E	X	X
Sodium Chloride - 5%	E	E	E	-	-	-	-	E	-	G	E	X	X
Sodium Chloride - 5% @ 150°F	E	E	E	-	-	-	-	E	-	G	E	-	X
Sodium Chloride Saturated (Boiling)	E	E	E	-	-	-	-	E	-	E	E	X	-
Sodium Chloride Saturated (Boiling)	E	-	-	-	-	-	-	-	-	G	E	X	-
Sodium Chloride Slurry		-	-	-	-	-	-	-	-	-	-	-	-

Underline is cover compound rating only. Many factors, such as temperature, concentration and length of exposure, are relevant to how chemical exposure affects the tube and cover or fitting material. The fluid manufacturers recommended maximum operating temperature should be carefully observed. Exceeding the manufacturer's recommended maximum temperature can result in fluid breakdown and cause harm or shorten life of tube and cover materials. There may be instances where the hose cover could be adversely affected by fluids which would not chemically affect the hose tube. Conversely, some fluids with an adverse affect on the tube of the hose may not have a deteriorating effect on the hose cover. It is recommended that the user test the hose/fluid compatibility to their own standards. Since no industry standards exist for chemical resistance, the Compass Chemical Resistance Guide for Elastomers is used whenever possible. Teflon® is a registered trademark of Dupont.

# Chemical Resistance Tables

The following is a representative list of fluids and manufacturers and a general guideline for the use and compatibility of Continental ContiTech hose and fittings.

## Rating Scale

E = Excellent resistance    X = Not recommended    Blank = No Data  
G = Good resistance    - = Testing recommended

Chemical Name	Hose								Fittings and Adapters				
	PTFE (Teflon®)	CR (Polychloropene)	NBR (Nitrile)	Nitrile/ PVC	CPE	CSM	Urethane	Nylon	Carbon Steel	Stainless Steel 304	Stainless Steel 316	Aluminum	Brass
Sodium Cyanide	E	E	E	E	E	E	E	E	G	E	E	X	X
Sodium Ferricyanide	E	-	-	-	-	-	-	-	G	G	G	-	-
Sodium Ferrocyanide	E	-	-	-	-	-	-	-	-	-	-	-	-
Sodium Fluoride	E	-	E	-	-	-	-	-	G	G	G	-	-
Sodium Fluoride (5%)	E	-	E	-	-	-	-	E	G	G	G	-	-
Sodium Fluoride (70%)	E	-	-	-	-	-	-	-	-	-	G	-	-
Sodium Hydrosulfide - 100% (to 70°F)	E	E	X	-	-	-	-	-	-	-	-	-	-
Sodium Hydrosulfide - 45% (to 500°F)	E	E	X	-	-	-	-	-	-	-	-	-	-
Sodium Hydrosulfite	E	-	-	-	-	-	-	-	-	-	-	-	-
Sodium Hydroxide	E	G	G	-	-	-	-	-	G	-	-	-	X
Sodium Hydroxide (10%)	E	-	-	-	E	-	-	-	-	-	-	-	-
Sodium Hydroxide (20% Cold)	E	E	G	-	-	-	-	E	E	E	E	X	X
Sodium Hydroxide (20% Hot)	E	E	X	-	-	-	-	-	G	E	E	X	X
Sodium Hydroxide (3M)	-	G	G	-	-	-	-	-	-	-	-	-	X
Sodium Hydroxide (40%)	E	E	G	G	E	E	-	G	G	E	E	X	X
Sodium Hydroxide (50% Cold)	E	G	X	X	E	E	-	G	G	G	G	X	X
Sodium Hydroxide (50% Hot)	E	-	-	-	E	G	-	X	X	G	G	X	X
Sodium Hydroxide (60%)	E	G	X	X	E	G	-	X	X	G	G	X	X
Sodium Hydroxide (70% Cold)	E	E	G	-	-	-	-	-	-	-	G	X	X
Sodium Hydroxide (70% Hot)	E	-	-	-	-	-	-	-	-	-	-	-	-
Sodium Hydroxide (80% Hot)	E	E	X	-	-	-	-	-	X	X	X	X	X
Sole													
Solnus Oils	-	-	E	-	-	-	G	E	E	E	E	E	E
Solvac 1535 G	-	-	-	-	G	-	-	E	-	-	-	-	-
Sour Crude Oil	-	-	-	-	-	-	-	-	-	-	-	-	-
Soybean Oil	E	G	G	G	-	G	-	E	E	E	E	E	-
Spent Acid	-	-	-	-	-	G	-	-	-	E	E	-	-
SR-10 Fuel	-	X	G	-	-	-	-	-	-	-	-	-	-
SR-6 Fuel	-	X	E	-	-	-	-	-	-	-	-	-	-
SRF Fluid B (Shell)	-	-	X	-	-	-	-	-	-	-	-	-	-
SRF Fluid C (Shell)	-	-	X	-	-	-	-	-	-	-	-	-	-
Stannic Chloride	E	X	G	G	E	X	-	X	X	X	X	X	X
Stannic Chloride, 50%	E	X	E	-	-	-	-	-	X	X	X	X	-
Stannous Chloride (Under 150°F)	E	E	E	-	E	E	-	X	-	X	G	X	-

Underline is cover compound rating only. Many factors, such as temperature, concentration and length of exposure, are relevant to how chemical exposure affects the tube and cover or fitting material. The fluid manufacturers recommended maximum operating temperature should be carefully observed. Exceeding the manufacturer's recommended maximum temperature can result in fluid breakdown and cause harm or shorten life of tube and cover materials. There may be instances where the hose cover could be adversely affected by fluids which would not chemically affect the hose tube. Conversely, some fluids with an adverse affect on the tube of the hose may not have a deteriorating effect on the hose cover. It is recommended that the user test the hose/fluid compatibility to their own standards. Since no industry standards exist for chemical resistance, the Compass Chemical Resistance Guide for Elastomers is used whenever possible. Teflon® is a registered trademark of Dupont.

# Chemical Resistance Tables

The following is a representative list of fluids and manufacturers and a general guideline for the use and compatibility of Continental ContiTech hose and fittings.

### Rating Scale

E = Excellent resistance    X = Not recommended    Blank = No Data  
 G = Good resistance    - = Testing recommended

Chemical Name	Hose								Fittings and Adapters				
	PTFE (Teflon®)	CR (Polychloropene)	NBR (Nitrile)	Nitrile/ PVC	CPE	CSM	Urethane	Nylon	Carbon Steel	Stainless Steel 304	Stainless Steel 316	Aluminum	Brass
Stannous Chloride, 15%	E	E	E	-	-	-	-	-	X	X	-	X	-
Stanoil N° 15, 18, 25, 31, 35, 51		-	E	-	-	-	G	E	E	E	E	E	E
Starch	E	G	G	-	-	E	E	E	X	E	E	E	-
Staysol FR		-	E	-	-	-	G	E	E	E	E	E	E
Steam-Water up to 250°F	E												
Stearic Acid	E	G	G	G	E	G	E	E	X	G	E	X	X
Stearin		-	-	-	-	-	E	G	-	-	-	-	-
Stoddard Solvent	E	G	G	X	E	-	X	E	G	E	E	E	E
Styrene (Monomer)	E	-	X	-	G	-	-	G	G	X	G	X	G
Styrene (Vinyl Benzene)		X	X	-	-	-	-	E	E	E	E	E	E
Sucrose Solutions	E	E	E	E	-	E	-	-	E	E	E	-	-
Sulfamic Acid (10% Under 170°F)	E	-	-	-	E	G	-	-	-	-	-	-	-
Sulfate Black Liquor	E	E	E	-	-	-	-	E	G	G	G	X	-
Sulfate Green Liquor	E	E	E	-	-	-	-	E	G	G	G	X	-
Sulfur	E												
Sulfur (Molten)		X	X	-	-	-	-	-	-	-	-	-	-
Sulfur Chloride	E	X	X	X	-	G	-	G	X	X	G	X	X
Sulfur Dioxide (Dry)	E	X	X	X	-	G	-	X	G	E	E	E	E
Sulfur Dioxide (Liquid)	E	G	X	-	-	G	-	-	-	-	-	-	-
Sulfur Dioxide (Moist)	E	G	X	-	-	G	-	E	-	G	E	E	X
Sulfur Hexafluoride (Gas) (to 70°F)	E	E	G	-	-	G	-	X	-	-	-	-	-
Sulfur Trioxide (Dry)	E	X	X	X	X	X	-	E	G	G	G	G	X
Sulfuric Acid (10%)	E	E	G	G	E	E	-	X	-	X	X	G	X
Sulfuric Acid (30%)	E	E	-	-	E	E	-	X	X	X	G	X	X
Sulfuric Acid (50%)	E	G	X	X	E	E	-	X	X	X	G	X	X
Sulfuric Acid (75%)	E	X	X	X	-	G	-	X	X	X	G	X	X
Sulfuric Acid (93%)	E	X	X	X	-	X	-	X	G	X	G	X	X
Sulfuric Acid (98%)	E	X	X	X	X	X	-	X	G	X	G	X	X
Sulfuric Acid, 3 Molar		X	X	-	-	-	-	-	-	-	-	-	-
Sulfuric Acid, 85%	E	X	X	-	-	-	-	-	X	G	E	X	-
Sulfuric Acid, Aerated, No Velocity	E	-	-	-	-	-	-	-	G	G	G	X	-
Sulfuric Acid, Air Free, No Velocity	E	-	-	-	-	-	-	-	X	X	G	X	-
Sulfuric Acid, Concentrated	E	X	X	-	-	-	-	-	-	E	E	-	-
Sulfuric Acid, Fuming, Oleum (Permiable)	E	X	-	-	-	-	-	-	G	E	E	G	-
Sulfurous Acid	E	G	G	-	-	-	-	X	X	X	G	G	-

Underline is cover compound rating only. Many factors, such as temperature, concentration and length of exposure, are relevant to how chemical exposure affects the tube and cover or fitting material. The fluid manufacturers recommended maximum operating temperature should be carefully observed. Exceeding the manufacturer's recommended maximum temperature can result in fluid breakdown and cause harm or shorten life of tube and cover materials. There may be instances where the hose cover could be adversely affected by fluids which would not chemically affect the hose tube. Conversely, some fluids with an adverse affect on the tube of the hose may not have a deteriorating effect on the hose cover. It is recommended that the user test the hose/fluid compatibility to their own standards. Since no industry standards exist for chemical resistance, the Compass Chemical Resistance Guide for Elastomers is used whenever possible. Teflon® is a registered trademark of Dupont.

## Chemical Resistance Tables

The following is a representative list of fluids and manufacturers and a general guideline for the use and compatibility of Continental ContiTech hose and fittings.

### Rating Scale

E = Excellent resistance    X = Not recommended    Blank = No Data  
G = Good resistance    - = Testing recommended

Chemical Name	Hose								Fittings and Adapters				
	PTFE (Teflon®)	CR (Polychloropene)	NBR (Nitrile)	Nitrile/PVC	CPE	CSM	Urethane	Nylon	Carbon Steel	Stainless Steel 304	Stainless Steel 316	Aluminum	Brass
Sulfurous Acid (10%)	E	-	X	-	E	E	-	-	-	X	G	E	X
Sulfurous Acid (75%)	E	X	X	X	E	E	-	X	X	X	G	X	X
Sulphuric Acid 10%	-	-	G	-	-	-	-	X	X	G	E	X	X
Sulphuric Acid 5%	-	-	E	-	-	-	-	X	G	G	E	X	X
Sulphuric Acid 5% Boiling	-	X	-	-	-	-	-	X	X	X	-	X	X
Sulphuric Acid 50%	-	X	X	-	-	-	-	X	X	X	X	X	X
Sulphuric Acid, Concentrated	-	X	X	-	-	-	-	X	-	E	E	X	X
Sulphuric Acid, Concentrated @ 300%	-	X	X	-	-	-	-	-	X	X	X	X	X
Sulphuric Acid, Concentrated Boiling	-	X	X	-	-	-	-	-	X	X	X	X	X
Sulphuric Acid, Fuming	-	X	-	-	-	-	-	-	G	G	G	X	-
Sulphuric Acid 10% Boiling	-	X	X	-	-	-	-	X	X	X	-	X	X
Sulphurous Acid, saturated	-	X	X	-	-	-	-	G	-	E	E	X	X
Sun Minesafe, Sunsafe	-	-	-	-	-	-	-	-	-	-	-	-	-
Sun R&O Oils	-	-	E	-	-	-	G	E	E	E	E	E	E
Sunsafe (Fire Resist.Hydr. Fluid) to 70°F	E	G	E	-	-	-	G	E	E	E	E	E	-
Suntac HP Oils	-	-	E	-	-	-	G	E	E	-	E	E	-
Suntac WR Oils	-	-	E	-	-	-	G	E	E	-	E	E	-
Sunvis Oils 700, 800, 900	-	-	E	-	-	-	G	E	E	E	E	-	-
Super Hydraulic Oils (Conoco)	-	-	E	-	-	-	G	E	E	E	E	E	-
Sutan Plus, Herbicide	-	X	X	X	E	-	-	E	E	E	E	E	-
Sutazine Plus, Herbicide	-	X	X	-	E	-	-	E	X	E	E	E	-
Synesstic	-	-	-	-	-	-	-	-	-	-	-	-	-
Synthetic Oil (Citgo)	-	-	-	-	-	-	G	E	E	E	E	-	-
Syrup	E	G	E	G	-	-	-	E	-	E	E	E	-
Tall Oil (Under 100°F)	E	G	G	G	-	X	-	-	G	X	G	X	-
Tallow	E	G	G	G	-	-	-	E	G	G	G	E	G
Tannic Acid (10%)	E	G	X	-	E	G	-	X	G	E	E	G	X
Tannin	-	E	E	-	-	-	-	E	-	-	-	-	-
Tar (Bituminous, Under 100°F)	E	G	G	G	X	-	-	-	E	E	E	E	G
Tar and Tar Oil	-	G	-	-	-	-	G	E	E	E	E	E	G
Tartaric Acid	E	G	G	G	E	E	-	E	X	G	G	G	X
Tellus Oils (to 70°F)	E	-	E	-	-	-	G	E	E	E	E	E	E
Tenol Oils	-	-	E	-	-	-	G	E	E	E	E	-	-
Tergitol	-	-	-	-	-	-	-	-	G	E	E	-	G
Terpineol	E	X	G	-	E	G	-	G	E	E	E	E	-

Underline is cover compound rating only. Many factors, such as temperature, concentration and length of exposure, are relevant to how chemical exposure affects the tube and cover or fitting material. The fluid manufacturers recommended maximum operating temperature should be carefully observed. Exceeding the manufacturer's recommended maximum temperature can result in fluid breakdown and cause harm or shorten life of tube and cover materials. There may be instances where the hose cover could be adversely affected by fluids which would not chemically affect the hose tube. Conversely, some fluids with an adverse affect on the tube of the hose may not have a deteriorating effect on the hose cover. It is recommended that the user test the hose/fluid compatibility to their own standards. Since no industry standards exist for chemical resistance, the Compass Chemical Resistance Guide for Elastomers is used whenever possible. Teflon® is a registered trademark of Dupont.

# Chemical Resistance Tables

The following is a representative list of fluids and manufacturers and a general guideline for the use and compatibility of Continental ContiTech hose and fittings.

### Rating Scale

E = Excellent resistance    X = Not recommended    Blank = No Data  
 G = Good resistance    - = Testing recommended

Chemical Name	Hose								Fittings and Adapters				
	PTFE (Teflon®)	CR (Polychloropene)	NBR (Nitrile)	Nitrile/ PVC	CPE	CSM	Urethane	Nylon	Carbon Steel	Stainless Steel 304	Stainless Steel 316	Aluminum	Brass
Terresstic		-	E	-	-	-	-	E	E	E	E	-	-
Tertiary Butyl Alcohol													
Tetra Chloro Benzene													
Tetra Chloro Ethane	E												
Tetra Chloro Ethylene (Permiable)	E												
Tetra Chloro Methane	E												
Tetra Chloro Naphthalene													
Tetra Ethylene Glycol													
Tetraethyl Lead		G	G	-	-	-	-	G	-	-	-	-	-
Tetraethyl Lead Bleach		X	G	-	-	-	-	-	-	-	-	-	-
Tetrahydrofuran (THF)		X	X	-	-	X	G	E	G	E	E	-	-
Tetralin		X	X	-	-	X	-	G	E	E	E	E	-
Texaco 760 Hydrafluid													
Texaco 766, 763 (200-300)													
Thiopen (to 70°F)	E	X	X	-	-	-	-	-	-	-	-	-	-
Tim-Sol													
Titanium Tetrachloride	E	X	X	X	-	-	-	-	E	G	G	X	X
Toluene (Toluol)	E	X	X	X	X	X	-	E	E	E	E	E	E
Toluene Diisocyanate (Under 150°F)	E	X	-	-	-	-	-	-	E	E	E	-	-
Transformer Oil (Askarel Types)		X	X	X	E	X	-	-	E	E	E	E	-
Transformer Oil (Petroleum Type)	E	G	E	G	E	X	G	E	E	E	E	E	E
Transmission Fluid Type A	E	G	E	G	E	G	-	G	E	E	E	E	E
Tributyl Phosphate	E	X	X	X	G	X	-	-	E	-	-	X	-
Tributoxyethyl Phosphate	E	X	X	X	X	X	-	G	E	-	-	X	-
Tributyl Phosphate	E												
Trichloro Acetic Aci	E												
Trichloro Etane (Permiable)	E												
Trichloroethylene (Permiable)	E	X	X	X	G	X	-	G	X	G	E	X	E
Trichloromonofluoroethane (Freon 113) (to 200°F)	E	-	E	-	-	-	-	-	E	E	E	X	-
Trichloromonofluoroethane (Freon 17) (to 200°F)	E	-	-	-	-	-	-	-	E	E	E	X	-
Tricresyl Phosphate	E	X	X	X	E	X	-	E	E	G	G	X	-
Triethanolamine (TEA)	E	G	G	-	E	G	-	E	E	E	E	E	E

Underline is cover compound rating only. Many factors, such as temperature, concentration and length of exposure, are relevant to how chemical exposure affects the tube and cover or fitting material. The fluid manufacturers recommended maximum operating temperature should be carefully observed. Exceeding the manufacturer's recommended maximum temperature can result in fluid breakdown and cause harm or shorten life of tube and cover materials. There may be instances where the hose cover could be adversely affected by fluids which would not chemically affect the hose tube. Conversely, some fluids with an adverse affect on the tube of the hose may not have a deteriorating effect on the hose cover. It is recommended that the user test the hose/fluid compatibility to their own standards. Since no industry standards exist for chemical resistance, the Compass Chemical Resistance Guide for Elastomers is used whenever possible. Teflon® is a registered trademark of Dupont.

# Chemical Resistance Tables

The following is a representative list of fluids and manufacturers and a general guideline for the use and compatibility of Continental ContiTech hose and fittings.

## Rating Scale

E = Excellent resistance    X = Not recommended    Blank = No Data  
G = Good resistance    - = Testing recommended

Chemical Name	Hose								Fittings and Adapters				
	PTFE (Teflon®)	CR (Polychloropene)	NBR (Nitrile)	Nitrile/ PVC	CPE	CSM	Urethane	Nylon	Carbon Steel	Stainless Steel 304	Stainless Steel 316	Aluminum	Brass
Triphenyl Phosphate													
Tripolyphosphate (STPP)		X	E	-	-	-	-	-	-	G	E	X	-
Trisodium Phosphate E													
Tung Oil ( to 400°F)	E	G	G	-	-	G	-	E	E	E	E	E	E
Turbine Oil #15 (MIL-L-7808A) (to 70°F)	E	X	E	-	-	-	-	-	E	E	E	E	-
Turbine Oil (to 250°F)	E	X	E	-	-	-	-	-	E	E	E	E	-
Turbo Oil #35		X	G	-	-	-	-	-	E	E	E	E	-
Turpentine	E	X	G	-	G	X	E	E	X	E	E	E	G
Tycol A Turbo 37, 50, 58, 60		-	E	-	-	-	G	E	E	E	E	-	-
Tycol Avalon 50, 57, 60		-	E	-	-	-	G	E	E	E	E	-	-
Type I Fuel (MIL-S-3136)													
ASTM Fuel A (to 300°F)	E	G	E	-	-	-	-	-	E	E	E	E	-
Type II Fuel (MIL-S-3136)		X	G	-	-	-	-	-	E	E	E	E	-
Type III Fuel (MIL-S-3136)													
ASTM Fuel B (to 300°F)	E	X	E	-	-	-	-	-	E	E	E	E	-
Ucon Hydrolube Types													
150CP, 200CP		-	E	-	-	-	G	E	E	E	E	E	E
Ucon Hydrolube Types													
275CP, 300CP, 550CP (to 70°F)	E	-	-	-	-	-	-	-	-	-	-	-	-
Ucon M1		-	E	-	-	-	G	E	E	E	E	E	E
Union ATF Dexron		-	E	-	-	-	G	E	E	E	E	E	E
Union ATF Type F		-	E	-	-	-	G	E	E	E	E	E	E
Union C-2 Fluid		-	E	-	-	-	G	E	E	E	E	E	E
Union C-P Oil		-	E	-	-	-	G	E	E	E	E	E	E
Union Hydraulic Oil AW		-	E	-	-	-	G	E	E	E	E	E	E
Union Hydraulic Tractor Fluid		-	E	-	-	-	G	E	E	E	E	E	E
Univis 40, Hydraulic Fluidon		G	E	-	-	-	-	-	E	E	E	E	-
Unleaded Gasoline	E												
Urea Solution	E	E	G	-	E	E	G	E	E	E	E	G	-
Urethane Formulations													
Uric Acid 100% (to 250°F)	E												
Uric Acid 75% (to 400°F)	E												
Varnish	E	X	X	X	X	X	-	E	G	E	E	E	G
Vaseline	E												
Vegetable Oils	E	G	E	G	E	-	G	E	E	E	E	E	G
Vegetable Oils (Hot)	-	-	-	-	-	-	E	G	G	G	E	G	-
Versilube	E	E	E	-	-	-	-	-	E	E	E	E	-

Underline is cover compound rating only. Many factors, such as temperature, concentration and length of exposure, are relevant to how chemical exposure affects the tube and cover or fitting material. The fluid manufacturers recommended maximum operating temperature should be carefully observed. Exceeding the manufacturer's recommended maximum temperature can result in fluid breakdown and cause harm or shorten life of tube and cover materials. There may be instances where the hose cover could be adversely affected by fluids which would not chemically affect the hose tube. Conversely, some fluids with an adverse affect on the tube of the hose may not have a deteriorating effect on the hose cover. It is recommended that the user test the hose/fluid compatibility to their own standards. Since no industry standards exist for chemical resistance, the Compass Chemical Resistance Guide for Elastomers is used whenever possible. Teflon® is a registered trademark of Dupont.

# Chemical Resistance Tables

The following is a representative list of fluids and manufacturers and a general guideline for the use and compatibility of Continental ContiTech hose and fittings.

### Rating Scale

E = Excellent resistance    X = Not recommended    Blank = No Data  
 G = Good resistance    - = Testing recommended

Chemical Name	Hose								Fittings and Adapters				
	PTFE (Teflon®)	CR (Polychloropene)	NBR (Nitrile)	Nitrile/ PVC	CPE	CSM	Urethane	Nylon	Carbon Steel	Stainless Steel 304	Stainless Steel 316	Aluminum	Brass
Versilube F-50, F-44 (to 70°F)	E	G	G	G	-	G	G	E	E	E	E	E	E
Vinyl Acetate	E	X	X	X	E	X	-	-	G	E	G	E	G
Vinyl Chloride (Chloroethylene, Monomer) (Permiabie)	E	X	X	X	X	X	-	-	G	E	E	G	X
Vital 4300, 5310													
Vitrea Oils		-	E	-	-	-	G	E	E	E	E	-	-
Volt Esso 35													
Water	E	E	E	E	E	E	E	E	E	E	E	E	E
Water Glycols	E												
Water in Oil Emulsion		-	-	-	-	-	G	E	-	-	-	-	-
Water, (Under 150°F)	E												
Water, (Up to 200°F)	E												
Water, Acid Mine	E	G	X	-	-	-	-	E	X	G	G	X	X
Water, Brine		G	G	-	-	E	E	E	X	G	G	-	-
Water, Demineralized	E	-	-	-	-	-	-	-	-	-	-	-	E
Water, Distilled	E	G	E	-	-	E	E	E	X	E	E	E	-
Water, Fresh	E	E	E	-	-	-	-	E	X	E	E	E	-
Water, Potable (FDA Tube Only)	E		Use FDA Hose only						E				
Water, Salt	E	G	E	-	-	-	-	E	X	G	G	X	
Whiskey	E											X	
White & Bagley N° 2190													
Cutting Oil		G	E	-	-	-	-	-	-	-	-	-	-
White Oil (to 70°F)	E												
White Pine Oil												X	
Wines	E		Use FDA Hose only										
Wood Alcohol													
Wood Oil (to 400°F)	E	G	E	-	E	G	E	E	E	E	E	E	
Xenon	E												
Xylene, Xylol	E	X	E	-	X	-	G	G	G	G	G	E	
Xylidine													
Zeric		-	E	-	-	-	G	G	-	-	-	-	
Zinc Acetate	E	G	X	-	-	X	-	G	E	E	E	E	
Zinc Carbonate (to 200°F)	E												
Zinc Chloride Solutions	E	E	E	E	E	E	-	E	X	G	E	X	
Zinc Chromate 75% (to 400°F)	E	-	-	-	E	E	-	-	-	E	E	-	

Underline is cover compound rating only. Many factors, such as temperature, concentration and length of exposure, are relevant to how chemical exposure affects the tube and cover or fitting material. The fluid manufacturers recommended maximum operating temperature should be carefully observed. Exceeding the manufacturer's recommended maximum temperature can result in fluid breakdown and cause harm or shorten life of tube and cover materials. There may be instances where the hose cover could be adversely affected by fluids which would not chemically affect the hose tube. Conversely, some fluids with an adverse affect on the tube of the hose may not have a deteriorating effect on the hose cover. It is recommended that the user test the hose/fluid compatibility to their own standards. Since no industry standards exist for chemical resistance, the Compass Chemical Resistance Guide for Elastomers is used whenever possible. Teflon® is a registered trademark of Dupont.

## Chemical Resistance Tables

The following is a representative list of fluids and manufacturers and a general guideline for the use and compatibility of Continental ContiTech hose and fittings.

### Rating Scale

E = Excellent resistance    X = Not recommended    Blank = No Data  
G = Good resistance        - = Testing recommended

Chemical Name	Hose								Fittings and Adapters				
	PTFE (Teflon®)	CR (Polychloropene)	NBR (Nitrile)	Nitrile/ PVC	CPE	CSM	Urethane	Nylon	Carbon Steel	Stainless Steel 304	Stainless Steel 316	Aluminum	Brass
Zinc Hydrate	-	-	-	-	-	-	G	-	-	-	-	-	-
Zinc Sulfate Solutions (to 300°F)	E	G	G	G	E	G	-	G	X	G	E	X	

Underline is cover compound rating only. Many factors, such as temperature, concentration and length of exposure, are relevant to how chemical exposure affects the tube and cover or fitting material. The fluid manufacturers recommended maximum operating temperature should be carefully observed. Exceeding the manufacturer's recommended maximum temperature can result in fluid breakdown and cause harm or shorten life of tube and cover materials. There may be instances where the hose cover could be adversely affected by fluids which would not chemically affect the hose tube. Conversely, some fluids with an adverse affect on the tube of the hose may not have a deteriorating effect on the hose cover. It is recommended that the user test the hose/fluid compatibility to their own standards. Since no industry standards exist for chemical resistance, the Compass Chemical Resistance Guide for Elastomers is used whenever possible. Teflon® is a registered trademark of Dupont.



# Temperature Conversion Chart

Locate temperature in middle column. If in °C, read °F equivalent in right-hand column; if in °F, read °C in left-hand column.

$$C = 0.556 (°F - 32) \quad F = (1.8 °C) + 32$$

-459° to 0°			1° to 60°			61° to 290°			300° to 890°			900° to 3000°		
C	C/F	F	C	C/F	F	C	C/F	F	C	C/F	F	C	C/F	F
-273	-459		-17.2	1	33.8	16.1	61	141.8	149	300	572	482	900	1652
-268	-450		-16.7	2	35.6	16.7	62	143.6	154	310	590	488	910	1670
-262	-440		-16.1	3	37.4	17.2	63	145.4	160	320	608	493	920	1688
-257	-430		-15.6	4	39.2	17.8	64	147.2	166	330	626	499	930	1706
-251	-420		-15.0	5	41.0	18.3	65	149.0	171	340	644	504	940	1724
-246	-410		-14.4	6	42.8	18.9	66	150.8	177	350	662	510	950	1742
-240	-400		-13.9	7	44.6	19.4	67	152.6	182	360	680	516	960	1760
-234	-390		-13.3	8	46.4	20.0	68	154.4	188	370	698	521	970	1778
-229	-380		-12.8	9	48.2	20.6	69	156.2	193	380	716	527	980	1796
-223	-370		-12.2	10	50.0	21.1	70	158.0	199	390	734	532	990	1814
-218	-360		-11.7	11	51.8	21.7	71	159.8	204	400	752	538	1000	1832
-212	-350		-11.1	12	53.6	22.2	72	161.6	210	410	770	549	1020	1868
-207	-340		-10.6	13	55.4	22.8	73	163.4	216	420	788	560	1040	1904
-201	-330		-10.0	14	57.2	23.3	74	165.2	221	430	806	571	1060	1940
-196	-320		-9.4	15	59.0	23.9	75	167.0	227	440	824	582	1080	1976
-190	-310		-8.9	16	60.8	24.4	76	168.8	232	450	842	593	1100	2012
-184	-300		-8.3	17	62.6	25.0	77	170.6	238	460	860	604	1120	2048
-179	-290		-7.8	18	64.4	25.6	78	172.4	243	470	878	616	1140	2084
-173	-280		-7.2	19	66.2	26.1	79	174.2	249	480	896	627	1160	2120
-169	-273	-459	-6.7	20	68.0	26.7	80	176.0	254	490	914	638	1180	2156
-168	-270	-454	-6.1	21	69.8	27.2	81	177.8	260	500	932	649	1200	2192
-162	-260	-436	-5.6	22	71.6	27.8	82	179.6	266	510	950	660	1220	2228
-157	-250	-418	-5.0	23	73.4	28.3	83	181.4	271	520	968	671	1240	2264
-151	-240	-400	-4.4	24	75.2	28.9	84	183.2	277	530	986	682	1260	2300
-146	-230	-382	-3.9	25	77.0	29.4	85	185.0	282	540	1004	693	1280	2336
-140	-220	-364	-3.3	26	78.8	30.0	86	186.8	288	550	1022	704	1300	2372
-134	-210	-346	-2.8	27	80.6	30.6	87	188.6	293	560	1040	732	1350	2462
-129	-200	-328	-2.2	28	82.4	31.1	88	190.4	299	570	1058	760	1400	2552
-123	-190	-310	-1.7	29	84.2	31.7	89	192.2	304	580	1076	788	1450	2642
-118	-180	-292	-1.1	30	86.0	32.2	90	194.0	310	590	1094	816	1500	2732
-112	-170	-274	-0.6	31	87.8	32.8	91	195.8	316	600	1112	843	1550	2822

# Temperature Conversion Chart

Locate temperature in middle column. If in °C, read °F equivalent in right-hand column; if in °F, read °C in left-hand column.

$$C = 0.556 (°F - 32) \quad F = (1.8 °C) + 32$$

-459° to 0°			1° to 60°			61° to 290°			300° to 890°			900° to 3000°		
C	C/F	F	C	C/F	F	C	C/F	F	C	C/F	F	C	C/F	F
-107	-160	-256	0.0	32	89.6	33.3	92	197.6	321	610	1130	871	1600	2912
-101	-150	-238	0.6	33	91.4	33.9	93	199.4	327	620	1148	899	1650	3002
-96	-140	-220	1.1	34	93.2	34.4	94	201.2	332	630	1166	927	1700	3092
-90	-130	-202	1.7	35	95.0	35.0	95	203.0	338	640	1184	954	1750	3182
-84	-120	-184	2.2	36	96.8	35.6	96	204.8	343	650	1202	983	1800	3272
-79	-110	-166	2.8	37	98.6	36.1	97	206.6	349	660	1220	1010	1850	3362
-73	-100	-148	3.3	38	100.4	36.7	98	208.4	354	670	1238	1038	1900	3452
-68	-90	-130	3.9	39	102.2	37.2	99	210.2	360	680	1256	1066	1950	3542
-62	-80	-112	4.4	40	104.0	37.8	100	212.0	366	690	1274	1093	2000	3632
-57	-70	-94	5.0	41	105.8	43	110	230	371	700	1292	1121	2050	3722
-51	-60	-76	5.6	42	107.6	49	120	248	377	710	1310	1149	2100	3812
-46	-50	-58	6.1	43	109.4	54	130	266	382	720	1328	1177	2150	3902
-40	-40	-40	6.7	44	111.2	60	140	284	388	730	1346	1204	2200	3992
-34	-30	-22	7.2	45	113.0	66	150	302	393	740	1364	1232	2250	4082
-29	-20	-4	7.8	46	114.8	71	160	320	399	750	1382	1260	2300	4172
-23	-10	14	8.3	47	116.6	77	170	338	404	760	1400	1288	2350	4262
-18	0	32	8.9	48	118.4	82	180	356	410	770	1418	1316	2400	4352
			9.4	49	120.2	88	190	374	416	780	1436	1343	2450	4442
			10.0	50	122.0	93	200	392	421	790	1454	1271	2500	4532
			10.6	51	123.8	99	210	410	427	800	1472	1399	2550	4622
			11.1	52	125.6	100	212	414	432	810	1490	1427	2600	4712
			11.7	53	127.4	104	220	428	438	820	1508	1454	2650	4802
			12.2	54	129.2	110	230	446	443	830	1526	1482	2700	4892
			12.8	55	131.0	116	240	464	449	840	1544	1510	2750	4982
			13.3	56	132.8	121	250	482	454	850	1562	1538	2800	5072
			13.9	57	134.6	127	260	500	460	860	1580	1566	2850	5162
			14.4	58	136.4	132	270	518	466	870	1598	1593	2900	5252
			15.0	59	138.2	138	280	536	471	880	1616	1621	2950	5342
			15.6	60	140.0	143	290	554	477	890	1634	1649	3000	5432

# Pressure Conversions

**Metric to psi (1 kPa = .145 psi)**

Kilo Pascals (kPa)	Mega Pascals (MPa)	Bar (Bar)	Pounds per Square Inch (psi)
100	0.1	1	14.5
200	0.2	2	29.0
300	0.3	3	43.5
400	0.4	4	58.0
500	0.5	5	72.5
600	0.6	6	87.0
700	0.7	7	101.5
800	0.8	8	116.0
900	0.9	9	130.5
1,000	1.0	10	145.0
2,000	2.0	20	290.1
3,000	3.0	30	435.1
4,000	4.0	40	580.2
5,000	5.0	50	725.2
6,000	6.0	60	870.2
7,000	7.0	70	1,015
8,000	8.0	80	1,160
9,000	9.0	90	1,305
10,000	10.0	100	1,450
20,000	20.0	200	2,901
30,000	30.0	300	4,351
40,000	40.0	400	5,802
50,000	50.0	500	7,252
60,000	60.0	600	8,702
70,000	70.0	700	10,153
80,000	80.0	800	11,603
90,000	90.0	900	13,053
100,000	100.0	1,000	14,504
200,000	200.0	2,000	29,008
300,000	300.0	3,000	43,511

**psi to Metric (1 psi = 6.89 kPa)**

Pounds per Square Inch (psi)	Kilo Pascals (kPa)	Mega Pascals (MPa)	Bar (Bar)
10	68.9	0.07	0.7
20	137.9	0.14	1.4
30	206.8	0.21	2.1
40	275.8	0.28	2.8
50	344.7	0.34	3.4
60	413.7	0.41	4.1
70	482.6	0.48	4.8
80	551.6	0.55	5.5
90	620.5	0.62	6.2
100	689	0.7	6.9
200	1,379	1.4	13.8
300	2,068	2.1	20.7
400	2,758	2.8	27.6
500	3,447	3.4	34.5
600	4,137	4.1	41.4
700	4,826	4.8	48.3
800	5,516	5.5	55.2
900	6,205	6.2	62.1
1,000	6,895	6.9	68.9
2,000	13,790	13.8	147.9
3,000	20,684	20.7	206.8
4,000	27,579	27.6	275.8
5,000	34,474	34.5	344.7
6,000	41,369	41.4	413.7
7,000	48,263	48.3	482.6
8,000	55,158	55.2	551.6
9,000	62,053	62.1	620.5
10,000	68,948	68.9	689
20,000	137,895	147.9	1,379
30,000	206,843	206.8	2,068
40,000	275,790	275.8	2,758

## Fraction Equivalents

Fittings

Fractions	Inches Decimals	Millimeters
1/64	0.015625	0.397
1/32	0.03125	0.794
3/64	0.046875	1.191
1/16	0.0625	1.588
5/64	0.078125	1.984
3/32	0.09375	2.381
7/64	0.109375	2.778
1/8	0.125	3.175
9/64	0.140625	3.572
5/32	0.15625	3.969
11/64	0.171875	4.366
3/16	0.1875	4.763
13/64	0.203125	5.159
7/32	0.21875	5.556
15/64	0.234375	5.953
1/4	0.250	6.350
17/64	0.265625	6.747
9/32	0.28125	7.144
19/64	0.296875	7.541
5/16	0.3125	7.938
21/64	0.328125	8.334
11/32	0.34375	8.731
23/64	0.359375	9.128
3/8	0.375	9.525
25/64	0.390625	9.922
13/32	0.40625	10.319
27/64	0.421875	10.716
7/16	0.4375	11.113
29/64	0.453125	11.509
15/32	0.46875	11.906
31/64	0.484375	12.303
1/2	0.500	12.700

Equipment &amp; Accessories

Fractions	Inches Decimals	Millimeters
33/64	0.515625	13.097
17/32	0.53125	13.494
35/64	0.546875	13.891
9/16	0.5625	14.288
37/64	0.578125	14.684
19/32	0.59375	15.081
39/64	0.609375	15.478
5/8	0.625	15.875
41/64	0.640625	16.272
21/32	0.65625	16.669
43/64	0.671875	17.066
11/16	0.6875	17.463
45/64	0.703125	17.859
23/32	0.71875	18.256
47/64	0.734375	18.653
3/4	0.750	19.050
49/64	0.765625	19.447
25/32	0.78125	19.844
51/64	0.796875	20.241
13/16	0.8125	20.638
53/64	0.828125	21.034
27/32	0.84375	21.431
55/64	0.859375	21.828
7/8	0.875	22.225
57/64	0.890625	22.622
29/32	0.90625	23.019
59/64	0.921875	23.416
15/16	0.9375	23.813
61/64	0.953125	24.209
31/32	0.96875	24.606
63/64	0.984375	25.003
1	1.000	25.400

Assemblies

Installation &amp; Maintenance

# Conversion Constants

## Length Conversion Constants

Metric to U.S.	U.S. to Metric
Millimeters x .039370 = inches	Inches x 25.4001 = millimeters
Meters x 39.370 = inches	Inches x .0254 = meters
Meters x 3.2808 = feet	Feet x .30480 = meters
Meters x 1.09361 = yards	Yards x .91440 = meters
Kilometers x 3,280.8 = feet	Feet x .0003048 = kilometers
Kilometers x .62137 = Statute Miles	Statute Miles x 1.60935 = kilometers
Kilometers x .53959 = Nautical Miles	Nautical Miles x 1.85325 = kilometers

## Weight Conversion Constants

Metric to U.S.	U.S. to Metric
Grams x 981 = dynes	Dynes x .0010193 = grams
Grams x 15.432 = grains	Grains x .0648 = grams
Grams x .03528 = ounces (Avd.)	Ounces (Avd.) x 28.35 = grams
Grams x .033818 = fluid ounces (water)	Fluid Ounces (Water) x 29.57 = grams
Kilograms x 35.27 = ounces (Avd.)	Ounces (Avd.) x .02835 = kilograms
Kilograms x 2.20462 = pounds (Avd.)	Pounds (Avd.) x .45359 = kilograms
Metric Tons (1000 Kg.) x 1.10231 = Net Ton (2000 lbs.)	Net Ton (2000 lbs.) x .90719 = Metric Tons (1000kg)
Metric Tons (1000 Kg.) x .98421 = Gross Ton (2240 lbs.)	Gross Ton (2240 lbs.) x 1.101605 = Metric Tons (1000kg)

## Area Conversion Constants

Metric to U.S.	U.S. to Metric
Square Millimeters x .00155 = square inches	Square Inches x 645.163 = square millimeters
Square Centimeters x .155 = square inches	Square Inches x 6.45163 = square centimeters
Square Meters x 10.76387 = square feet	Square Feet x .0929 = square meters
Square Meters x 1.19599 = square yards	Square Yards x .83613 = square meters
Hectares x 2.47104 = acres	Acres x .40469 = hectares
Square Kilometers x 247.104 = acres	Acres x .0040469 = square kilometers
Square Kilometers x .3861 = square miles	Square Miles x 2.5899 = square kilometers

## Pressure Conversion Constants

Metric to U.S.	U.S. to Metric
Bar x 14.5 = psi	psi x .0689 = Bar
Megapascals x 145.0 = psi	psi x .0069 = Megapascals (MPa)
kgf/cm <sup>2</sup> x 14.22 = psi	psi x .0703 = kgf/cm <sup>2</sup>

## Family Part Number - Alphanumeric Index

## Descriptive #

	Descriptive #	Page #	Descriptive #	Page #
	AC-COTF134V90B.....	264	AC-SFM45 .....	276
	AC-COTF45 .....	264	AC-SFM90 .....	276
	AC-COTF90 .....	264	AC-SWA.....	293
	AC-COTF90B.....	264	AC-SWCN.....	293
	AC-FTM.....	265	AC-SWCW .....	293
	AC-FTM90B.....	265	AC-VA12V1/4 .....	293
	AC-FTMM.....	265	AC-VA12V3/16.....	293
	AC-FTN.....	291	AC-VC12V .....	293
	AC-FTS.....	292	AC-VC134VHS.....	293
	AC-FTSM.....	292	AC-VC134VLS .....	293
	AC-HM.....	266	AC-VCORE .....	294
	AC-HM12V .....	266	ACP3 .....	M, 16, 37-38, 44-45
	AC-HM134V .....	266	Aluminum.....	370-403
	AC-HM90 .....	266	AR16SC.....	M, 14
	AC-HMSG .....	267	ARC12.....	I, L, 17, 39-40, 44-45
	AC-HMT .....	267	ARC13.....	I, L, 18, 39-40, 44-45
	AC-ILOTBLK.....	292	ARC15.....	I, M, 19, 39-40, 44-45
	AC-ILOTBLU.....	292	ARC16SC.....	I, M, 14, 37-48, 44-45
	AC-ILOTORA.....	292	B2-BFFX .....	83
	AC-ILOTRED .....	292	B2-BPFX .....	81
	AC-ILOTWHI .....	292	B2-BPFX45.....	81
	AC-OIM.....	267	B2-BPFX90.....	82
	AC-OIM134V .....	268	B2-BPM .....	82
	AC-OIM134V90.....	269	B2-BTM .....	83
	AC-OIM45.....	267	B2-DHFX.....	86
	AC-OIM90 .....	268	B2-DHFX45.....	86
	AC-OIMB.....	268	B2-DHFX90 .....	87
	AC-OIMB90.....	268	B2-DHFX90XL.....	87
	AC-OTCF10.....	290	B2-DHM.....	87
	AC-OTF.....	269	B2-DLFX.....	84
	AC-OTF06.....	290-291	B2-DLFX45.....	84
	AC-OTF08.....	290-291	B2-DLFX90 .....	85
	AC-OTF10.....	290-291	B2-DLM.....	85
	AC-OTF12.....	290-291	B2-DNFX45.....	88
	AC-OTF12V.....	271	B2-DNFX90 .....	88
	AC-OTF12V90 .....	271	B2-FH.....	76
	AC-OTF134V .....	272	B2-FH45.....	78
	AC-OTF134V45 .....	272	B2-FH90.....	79
	AC-OTF134V90.....	272	B2-FL .....	73
	AC-OTF134VHS.....	272	B2-FL22.....	73
	AC-OTF180.....	270	B2-FL30.....	74
	AC-OTF45.....	269	B2-FL45.....	74
	AC-OTF90 .....	270	B2-FL60.....	75
	AC-OTF90B.....	270	B2-FL67.....	75
	AC-OTFM.....	270	B2-FL90.....	76
	AC-OTFM45.....	271	B2-FTM.....	66
	AC-OTFM90.....	271	B2-GTF .....	65
	AC-OTM.....	273	B2-JCFX .....	55-56
	AC-OTM134V .....	274	B2-JCFX45 .....	56
	AC-OTM134V90.....	274	B2-JCFX90.....	57-58
	AC-OTM45.....	273	B2-JCFX90L.....	57-58
	AC-OTM90.....	273	B2-JCFX90S.....	57-58
	AC-OTMLP .....	274	B2-JCM.....	58-59
	AC-OTUBE.....	293	B2-JSFX.....	90
	AC-SFFX .....	274	B2-KF.....	79
	AC-SFFX45.....	275	B2-KF45.....	80
	AC-SFFX90.....	275	B2-KF90.....	80
	AC-SFM.....	275	B2-KMFX .....	89

Fittings

Equipment &amp; Accessories

Assemblies

Installation &amp; Maintenance

Appendix

## Family Part Number – Alphanumeric Index

Descriptive #

Descriptive #	Page #	Descriptive #	Page #
B2-KMFX45	89	DG-FH	167
B2-KMFX90	90	DG-FH45	169
B2-NPF	62	DG-FH90	171
B2-NPFX	62	DG-FL	161
B2-NPM	63, 252, 256	DG-FL30	162
B2-NPMX	64	DG-FL45	163
B2-NPMX90B	64	DG-FL90	165
B2-NSFX	65	DG-JCFX	149
B2-OBM	71	DG-JCFX45	150
B2-OBMX	72	DG-JCFX90	151
B2-OBMX90B	72	DG-JCM	152
B2-OFFX	67	DG-NPM	153
B2-OFFX45	68	DG-NPMAPL	155, 254
B2-OFFX90	69	DG-OFFX	156
B2-OFFX90L	69	DG-OFFX45	157
B2-OFFX90S	69	DG-OFFX90	158
B2-OFM	70	DGF1	298
B2-SFFX	59	DGF2	298
B2-SFFX45	59	DR16	13
B2-SFFX90	60	DR16SC	I, J, M, 13, 37, 38, 43, 45
B2-SFFX90L	60	DR1SN	I, J, K, 11, 37, 38, 43, 45
B2-SFFX90S	60	DR2SN	A, I, J, K, 12, 37, 38, 43, 46
B2-SFM	60	DR5	J, K, 30
B2-SIMX	60-61	FG-JCFX	218
B2-SIMX45	61	FG-JCFX45	219
B2-SIMX90	61-62	FG-JCFX90	220-221
B2-SP	66	FG-JCFX90L	220-221
B2-SP45	67	FG-JCM	222
BOP	A, N, 26, 39-40, 44-45	FG-NPM	228
BOP5000	26	FG-OBM	235
BR7	J, L, 22, 39-40, 43, 45	FG-SFFX	223
Brass	370-403	FG-SFM	225
Carbon Steel	370-403	FG-SIMX	226
CB102	323	FL61SC	305
CB103	323	FL62SC	305
CB203	323	FLEXA-Grip™	J, N, 9, 37, 38, 44, 45
CB203-DIV	323	G4826	N, 33, 41-42, 336
CB204	323	G4867	N, 33, 41-42, 336
CB204-DIV	323	G4890	N, 34, 41-42, 335
CB205	323	GC-CB12VS90	276
CB205-DIV	323	GC-CB12VSR90	276
CB206	323	GC-CLIP	294
CB206-DIV	323	GC-CLIPHLDR	294
CB303	321	GC-COTF134V90B	277
CPE	370-403	GC-COTF45	277
CR	370-403	GC-COTF90	277
CSM	370-403	GC-COTF90B	277
Desert® DUT	J, K, 32, 41-43, 45	GC-FSLF	279
DG-BPFX	177	GC-FSLF45	279
DG-BPFX45	178	GC-FSLF90	279
DG-BPFX90	179	GC-FSLM	279
DG-CF	172	GC-FSLM45	280
DG-CF45	174	GC-FSLM90	280
DG-CF90	176	GC-FTBO	277
DG-DHFX	183	GC-FTM	278
DG-DHFX45	184	GC-FTM90B	278
DG-DHFX90	184	GC-FTMM	278
DG-DHM	185	GC-HM	280

## Family Part Number - Alphanumeric Index

## Descriptive #

Descriptive #	Page #	Descriptive #	Page #
GC-HM12V.....	281	IGTC.....	J, N, 9, 37-38, 44-45
GC-HM134V.....	281	LR2AT.....	12
GC-HM180.....	281	LR2SN.....	I, K, 12, 37, 38, 43, 45
GC-HM90.....	280	M13531.....	N, 35, 43, 44
GC-HMSG.....	281	M3992.....	N, 36, 41-42, 44-45
GC-HMT.....	282	M8788.....	N, 36, 41, 42, 44
GC-OFFX.....	282	MIL-H-13444-I.....	N, 34, 41, 42, 44, 45
GC-OFFX90.....	282	MIL-H-13444-III.....	N, 35, 41, 42, 44, 45
GC-OFSL.....	292	NBR.....	370-403
GC-OIM.....	282	Nitrile.....	370-403
GC-OIM134V.....	284	NR7.....	J, L, 22, 39, 40, 43, 45
GC-OIM134V90.....	284	NR8.....	J, L, 24, 39, 40, 43, 45
GC-OIM45.....	283	NSFX.....	J, M, 25, 39, 40, 43, 45
GC-OIM90.....	283	Nylon.....	370-403
GC-OIMB.....	283	O6162.....	304
GC-OIMB90.....	283	OBSPP.....	303
GC-OSWCH.....	293	ODIN24H.....	303
GC-OTF.....	284	ODIN24L.....	303
GC-OTF12V.....	285	OORFS.....	304
GC-OTF12V90.....	286	ORB.....	304
GC-OTF134V.....	286	PB-HM.....	257
GC-OTF134V45.....	286	PB-JCFX.....	257
GC-OTF134V90.....	286	PB-JCFX90.....	257
GC-OTF134VHS.....	286	PB-JCM.....	258
GC-OTF180.....	285	PB-NPF.....	258
GC-OTF45.....	284	PB-NPM.....	258-259
GC-OTF90.....	285	PB-NPM90.....	259
GC-OTF90B.....	285	PB-NPMX.....	260
GC-OTM.....	287	PB-SFFX.....	260
GC-OTM134V.....	288	PB-SFM.....	260
GC-OTM134V90.....	288	PB-SIF.....	261
GC-OTM45.....	287	PB-SIM.....	261
GC-OTM90.....	287	PC1000.....	Q, 320
GC-OTMLP.....	288	PC1000-P.....	Q, 320
GC-PLIERS.....	294	PC1000-PX.....	320
GC-SFFX.....	288	PC125RCD.....	313, 336
GC-SFFX45.....	289	PC125M.....	Q, 311
GC-SFFX90.....	289	PC150.....	Q, 314
GC-SFM.....	289	PC150H.....	Q, 315
GC-SFM45.....	290	PC200.....	Q, 316
GC-SFM90.....	290	PC200/400.....	317
GFIT100.....	307	PC400.....	317
GG-NPM.....	256	PC440-P.....	Q, 318
GTEXS.....	46	PC600.....	319
HCT.....	294	PC600-P.....	319
HCTRB.....	294	PC600L-P.....	Q, 319
Hot Oiler.....	A, N, 27, 39-40	PCTB-1500.....	321
HR4.....	J, K, 7, 37-38, 43, 45	PCTB-2500.....	321
HR6.....	J, L, 6, 37-38, 43, 45	PTFE.....	370-403
HRC.....	47	PVC.....	370-403
HS150.....	319	S4-BPFX.....	81, 138-139
HS301.....	322	S4-BPFX45.....	81, 139
HS303.....	322	S4-BPFX90.....	82, 140
HS501.....	322	S4-BPM.....	82, 140
HS503.....	322	S4-BTM.....	141
HWRAP.....	46	S4-CF.....	133
IG.....	J, M, 8, 37-38, 44-45	S4-CF22.....	134
IGHT.....	J, M, 8, 37-38, 44-45	S4-CF30.....	134



## Family Part Number - Alphanumeric Index

Descriptive #

Descriptive #	Page #	Descriptive #	Page #
S4-CF45.....	135	S6-BPM.....	180
S4-CF60.....	135	S6-BTM.....	180
S4-CF67.....	136	S6-CF.....	172
S4-CF90.....	136	S6-CF22.....	172-173
S4-DHFX.....	86, 143	S6-CF30.....	173
S4-DHFX45.....	144	S6-CF45.....	174
S4-DHFX90.....	87, 145	S6-CF60.....	175
S4-DLFX.....	84, 142	S6-CF67.....	175
S4-DLFX45.....	84, 142	S6-CF90.....	176
S4-DLFX90.....	85, 143	S6-CF90L.....	176
S4-DLFX90XL.....	85, 143	S6-DHFX.....	183
S4-FH.....	76, 128-129	S6-DHM.....	185
S4-FH22.....	77, 129	S6-FH.....	167
S4-FH30.....	77, 130	S6-FH22.....	168
S4-FH45.....	78, 130	S6-FH30.....	168
S4-FH60.....	78, 131	S6-FH45.....	169
S4-FH67.....	131	S6-FH60.....	170
S4-FH90.....	79, 132	S6-FH67.....	170
S4-FL.....	73, 122	S6-FH90.....	170
S4-FL110.....	127	S6-FH90L.....	171
S4-FL135.....	128	S6-FL.....	161
S4-FL22.....	73, 123	S6-FL22.....	162
S4-FL30.....	74, 123-124	S6-FL30.....	162
S4-FL45.....	74, 124	S6-FL45.....	163
S4-FL60.....	75, 125	S6-FL60.....	164
S4-FL67.....	75, 126	S6-FL67.....	164
S4-FL90.....	76, 126-127	S6-FL90.....	165
S4-FL90L.....	126-127	S6-IHUF1502.....	255
S4-IHUF1502.....	255	S6-IHUM1502.....	255
S4-IHUM1502.....	255	S6-JCFX.....	149
S4-JCFX.....	56, 108	S6-JCFX45.....	150
S4-JCFX45.....	56, 109	S6-JCFX90.....	151
S4-JCFX90.....	58, 110-111	S6-JCM.....	152
S4-JCFX90L.....	110	S6-NPM.....	153
S4-JCFX90S.....	110	S6-NPMAPI.....	155, 254
S4-JCM.....	59, 112	S6-OFFX.....	156
S4-JSFX.....	90, 147	S6-OFFX45.....	157
S4-KF.....	137	S6-OFFX90.....	158
S4-KF45.....	137	S6-OFFX90S.....	158
S4-KF90.....	138	S6-OFM.....	159
S4-KMFX.....	89, 146	SCP3.....	I, M, 15, 37, 38, 44, 45
S4-NPM.....	63, 113	SCX5.....	K, 31, 41, 42, 43, 45
S4-NPMAPI.....	255	SF-JCFX.....	253
S4-NPMX.....	114	SF-NPM.....	253
S4-NSFX.....	65, 115	SF-NPMX.....	253
S4-OBM.....	71, 121	SF-OBM.....	254
S4-OFFX.....	67, 116	SF-OBMX.....	254
S4-OFFX45.....	68, 117	SFS.....	I, M, 10, 37, 38, 43, 45
S4-OFFX90.....	70, 119	SG-BFFX.....	141, 181
S4-OFFX90L.....	70, 118	SG-BPFX.....	139, 177-178
S4-OFFX90S.....	70, 118	SG-BPFX45.....	139, 178
S4-OFM.....	70, 120	SG-BPFX90.....	140, 179
S4H-NPMAPI.....	254	SG-BPM.....	141, 180
S4SH.....	J, L, 20, 39, 40, 43, 45	SG-BTM.....	141, 181
S4SP.....	J, L, 39, 40, 43, 45, 20	SG-CF.....	133, 172
S6-BPFX.....	177	SG-CF22.....	134, 173
S6-BPFX45.....	178	SG-CF30.....	134, 173
S6-BPFX90.....	179	SG-CF45.....	135, 174

## Family Part Number - Alphanumeric Index

## Descriptive #

Descriptive #	Page #	Descriptive #	Page #
SG-CF60	136, 175	SHR	N, 25, 39-40, 44, 45
SG-CF90	137, 176	HR3000	25
SG-CF90L	137, 176	SHR3650	25
SG-DHFX	144, 183	SHR5000	25
SG-DHFX45	144, 184	SR12	J, L, 17, 39-40, 43, 45
SG-DHFX90	145, 184	SR13	J, L, 18, 39-40, 42, 45
SG-DHM	145, 185	SR14A	J, L, 28, 41, 42, 44, 45
SG-DLFX	142, 181	SR15	J, L, 19, 39, 40, 44, 45
SG-DLFX45	142, 182	SR16SC	I, M, 13, 37, 38, 44, 45
SG-DLFX90	143, 182	SR18	M, 24, 39, 40, 44, 45
SG-DLM	144, 182	SR1SN	I, K, 10, 37, 38, 43, 45
SG-FH	129, 167	SR2SN	I, K, 11, 37, 38, 43, 45
SG-FH22	129, 168	SR3	J, K, 7, 37, 38, 43, 45
SG-FH30	130, 169	SR5	J, K, 29, 41-43, 45
SG-FH45	131, 169	SR6	J, K, 6, 37, 38, 43, 45
SG-FH60	131, 170	SR7	L, 21, 39, 40, 43, 45
SG-FH67	132, 170	SR8	L, 23, 39, 40, 43, 45
SG-FH90	132-133, 171	Stainless Steel 304	370-403
SG-FL	122, 161	Stainless Steel 316	370-403
SG-FL110	128, 166	T7-BPFX	105
SG-FL135	128, 166	T7-BPFX90	106
SG-FL22	123, 162	T7-FTM	101
SG-FL30	124, 162	T7-JCFX	92
SG-FL45	125, 163	T7-JCFX45	93
SG-FL60	125, 164	T7-JCFX90	94
SG-FL67	126, 164	T7-JCFX90L	94
SG-FL90	127, 165	T7-JCM	95
SG-FL90L	127, 165	T7-JSFX	106
SG-IHUF1502	255	T7-NPF	98
SG-IHUM1502	255	T7-NPM	99
SG-JCFX	108-109, 149	T7-NPMX	100
SG-JCFX45	110, 150	T7-NSFX	100
SG-JCFX90	111, 151	T7-OBM	104
SG-JCFX90L	111, 151	T7-OBMX	104
SG-JCFX90S	111, 151	T7-OBMX90B	105
SG-JCM	112, 152	T7-OFFX	102
SG-JSFX	147, 186	T7-OFFX45	102
SG-KF	137, 176	T7-OFFX90	103
SG-KF45	138, 177	T7-OFFX90L	103
SG-KF90	138, 177	T7-OFM	103
SG-KMFX	146, 185	T7-SFFX	96
SG-KMFX45	146, 186	T7-SFFX90	96
SG-KMFX90	147, 186	T7-SIMX	97
SG-NPF	153	T7-SIMX90	98
SG-NPM	113, 153-154	T7-SP45	101
SG-NPMAPI	115, 155, 254	T8-BPFX	105
SG-NPMX	114, 154	T8-BPFX90	106
SG-NSFX	115, 155	T8-DNFX90	106
SG-OBM	121, 160	T8-FTM	101
SG-OFFX	116-117, 157	T8-JCFX	92
SG-OFFX45	117-118, 158	T8-JCFX45	93
SG-OFFX90	119, 159	T8-JCFX90	94
SG-OFFX90L	119, 159	T8-JCFX90L	94
SG-OFFX90S	119, 159	T8-JCM	95
SG-OFM	120, 160	T8-JSFX	106
SG-SP	116, 156	T8-NPF	98
SGUN	M, 39-40, 44, 45, 207	T8-NPM	99
SHJ	M, 39-40, 44, 45, 208	T8-NPMX	100

Fittings

Equipment &amp; Accessories

Assemblies

Installation &amp; Maintenance

Appendix

## Family Part Number - Alphanumeric Index

Descriptive #

Descriptive #	Page #	Descriptive #	Page #
T8-NSFX.....	100	UC-OBMX90B.....	202, 236
T8-OBM.....	104	UC-OFFX.....	198, 232
T8-OBMX.....	104	UC-OFFX45.....	199, 233
T8-OBMX90B.....	105	UC-OFFX90.....	200, 233-234
T8-OFFX.....	102	UC-OFFX90L.....	200, 233-234
T8-OFFX45.....	102	UC-OFFX90S.....	200, 233-234
T8-OFFX90.....	103	UC-OFM.....	201, 234
T8-OFFX90L.....	103	UC-SFFX.....	191, 224
T8-SFFX.....	96	UC-SFFX45.....	192, 224
T8-SFFX90.....	96	UC-SFFX90.....	192, 225
T8-SIMX45.....	97	UC-SFFX90L.....	192, 225
T8-SIMX90.....	98	UC-SFFX90S.....	192, 225
T8-SP45.....	101	UC-SFM.....	192, 226
TR7.....	L, 21, 39, 40, 43, 45	UC-SIMX.....	193, 226
TR8.....	L, 23, 39, 40, 43, 45	UC-SIMX45.....	193, 227
UC-BFFX.....	210, 240	UC-SIMX90.....	194, 227
UC-BPFX.....	207, 238	UC-SP.....	197, 231
UC-BPFX45.....	208, 238	UC-SP45.....	197, 232
UC-BPFX90.....	208, 239	UCF1.....	295
UC-BPM.....	209, 239	UCF10.....	298
UC-BTM.....	209, 239	UCF11.....	298
UC-DHFX.....	212, 242	UCF2.....	295
UC-DHFX45.....	213, 243	UCF3.....	295
UC-DHFX90.....	213, 243	UCF4.....	296
UC-DHM.....	214, 243	UCF5.....	296
UC-DLFX.....	210, 240	UCF6.....	296
UC-DLFX45.....	211, 241	UCF7.....	297
UC-DLFX90.....	211, 241	UCF8.....	297
UC-DLM.....	212, 242	UCF9.....	297
UC-DNFX45.....	214, 244	UCH-JCFX.....	55, 188, 218
UC-DNFX90.....	215, 244	Urethane.....	370-403
UC-FH.....	206	UT-FL90EOC.....	251
UC-FH45.....	206	UT-FTM.....	251
UC-FH90.....	207, 237	UT-JCFX.....	247
UC-FL.....	203, 236	UT-JCFX45.....	247
UC-FL22.....	203	UT-JCFX90.....	248
UC-FL30.....	204	UT-NPM.....	250
UC-FL45.....	204, 237	UT-PTTFX.....	251
UC-FL60.....	205	UT-SFFX.....	248
UC-FL90.....	205, 237	UT-SFFX45.....	248
UC-FTM.....	197, 231	UT-SFFX90.....	249
UC-JCFX.....	188, 218-219	UT-SIMX.....	249
UC-JCFX45.....	189, 220	UT-SIMX45.....	249
UC-JCFX90.....	190, 221-222	UT-SIMX90.....	250
UC-JCFX90L.....	190, 221-222	XCP3.....	A, I, M, 15, 37, 38, 44, 45
UC-JCFX90S.....	190, 221-222	XR16SC.....	A, I, M, 14, 37, 38, 44, 45
UC-JCM.....	191, 223		
UC-JSFX.....	216, 245		
UC-KMFX.....	215, 244		
UC-KMFX45.....	216, 245		
UC-KMFX90.....	216, 245		
UC-NPF.....	194, 228		
UC-NPM.....	63, 195, 229		
UC-NPMX.....	196, 230		
UC-NPMX90B.....	196, 230		
UC-NSFX.....	196, 231		
UC-OBM.....	201, 235		
UC-OBMX.....	202, 236		

Hoses

Fittings

Equipment &amp; Accessories

Assemblies

Installation &amp; Maintenance

Appendix

# Family Part Number - Alphanumeric Index

## Product #

	Product #	Page #	Product #	Page #
Fittings	14100	83	14777	59
	14105	81	14780	60
	14115	81	14781	60
	14120	82	14783	60
	14130	82	14785	60
	14170	83	14800	60-61
	14210	86	14810	61
	14215	86	14815	61-62
	14220	87	14825	66
	14225	87	14830	67
	14240	84	16105	177
	14245	84	16115	178
	14250	85	16120	179
	14255	85	16185	172
Equipment & Accessories	14275	88	16190	174
	14280	88	16195	176
	14300	76	16210	183
	14310	78	16215	184
	14315	79	16220	184
	14320	73	16225	185
	14330	73	16300	148, 167
	14335	74	16310	169
	14340	74	16315	171
	14345	75	16320	161
	14347	75	16335	162
	14350	76	16340	163
	14360	66	16350	165
	14370	65	16400	149
Assemblies	14400	54-56	16420	150
	14420	56	16425	151
	14425	57-58	16450	152
	14440	57-58	16615	153
	14445	57-58	16630	155, 254
	14450	58-59	16700	156
	14520	90	16710	157
	14530	79	16715	158
	14535	80	18400	217-218
	14540	80	18420	219
	14545	89	18425	220-221
	14548	89	18440	220-221
	14550	90	18450	222
	14600	62	18615	228
Installation & Maintenance	14605	62	18670	235
	14615	63, 252, 256	18775	223
	14645	64	18785	225
	14650	64	18800	226
	14655	65	20615	256
	14670	71	22380	257
	14680	72	22400	257
	14685	72	22425	257
	14700	67	22450	258
	14710	68	22600	258
	14715	69	22615	258-259
	14720	69	22625	259
	14725	69	22645	260
	14730	70	22775	260
14775	59	22785	260	
		22790	261	

## Family Part Number - Alphanumeric Index

Product #

Product #	Page #	Product #	Page #
22795.....	261	28645.....	107-114
26400.....	253	28655.....	65, 115
26615.....	253	28670.....	71, 121
26645.....	253	28700.....	67, 1167
26670.....	254	28710.....	68, 117
26680.....	254	28715.....	70, 118
28105.....	81, 138-139	28720.....	70, 118
28115.....	81, 139	28725.....	70, 118
28120.....	82, 140	28730.....	70, 120
28130.....	82, 140	29105.....	139, 177-178
28170.....	141	29115.....	139, 178
28185.....	133	29120.....	140, 179
28187.....	134	29130.....	141, 180
28188.....	134	29170.....	141, 181
28190.....	135	29185.....	133, 172
28192.....	135	29187.....	134, 173
28194.....	136	29188.....	134, 173
28195.....	136	29190.....	135, 174
28210.....	86, 143	29192.....	136, 175
28215.....	144	29195.....	137, 176
28220.....	87, 145	29197.....	176
28224.....	85	29210.....	144, 184
28240.....	84, 142	29215.....	144, 184
28245.....	84, 142	29220.....	145, 184
28250.....	85, 143	29225.....	145, 185
28300.....	76, 128-129	29240.....	112, 142, 150, 181
28303.....	77, 129	29245.....	142, 182
28305.....	77, 130	29250.....	144, 182
28310.....	78, 130	29255.....	182
28312.....	78, 131	29300.....	129, 167
28313.....	131	29303.....	129, 168
28315.....	79, 132	29305.....	130, 169
28320.....	73, 122	29310.....	131, 169
28330.....	73, 123	29312.....	131, 170
28335.....	74, 123-124	29313.....	132, 170
28340.....	74, 124	29315.....	132-133, 171
28345.....	75, 125	29317A.....	132-133, 171
28347.....	75, 126	29317B.....	132-133, 171
28350.....	76, 126-127	29320.....	122, 161, 167
28352.....	126-127	29330.....	123, 162
28354.....	127-128	29335.....	124, 162
28355.....	128	29340.....	125, 163, 169
28390.....	255	29345.....	125, 164
28395.....	255	29347.....	126, 164
28400.....	56, 108	29350.....	127, 165
28420.....	56, 109	29352.....	127, 165
28423.....	109	29354.....	128, 166
28425.....	58, 110-111	29355.....	128, 166
28440.....	110	29390.....	255
28445.....	110	29395.....	255
28450.....	59, 112	29400.....	108-109, 149
28520.....	90, 147	29420.....	110, 150
28530.....	137	29425.....	111, 151
28535.....	137	29440.....	111, 151
28540.....	138	29445.....	111, 151
28545.....	89, 146	29450.....	112, 152
28615.....	63, 113	29520.....	147, 186
28617.....	255	29530.....	137, 176

Hoses

Fittings

Equipment &amp; Accessories

Assemblies

Installation &amp; Maintenance

Appendix

## Family Part Number - Alphanumeric Index

Product #

Product #	Page #	Product #	Page #
29535	138, 177	30710	157
29540	138, 177	30715	158
29545	146, 185	30725	158
29548	146, 186	30730	159
29550	147, 186	32105	105
29600	153	32120	106
29615	114, 153-154	32360	101
29617	115, 155	32400	91-92
29630	254	32420	93
29645	114, 154	32425	94
29655	115, 155	32440	94
29670	121, 160	32450	95
29700	116-117, 157	32520	106
29710	117-118, 158	32600	98
29715	119-120, 159	32615	99
29720	119-120, 159	32645	100
29725	119-120, 159	32655	100
29730	120, 160	32670	104
30105	177	32680	104
30110	178	32685	105
30115	178	32700	102
30120	179	32710	102
30130	180	32715	103
30170	180	32720	103
30185	172	32730	103
30187	172-173	32775	96
30188	173	32780	96
30190	174	32800	97
30192	175	32815	98
30194	175	32830	101
30195	176	34105	105
30197	176	34120	106
30210	183	34280	106
30225	185	34360	101
30300	148, 167	34400	92
30303	168	34420	93
30305	168	34425	94
30310	169	34440	94
30312	170	34450	95
30313	170	34520	106
30315	171	34600	98
30317	171	34615	99
30320	161	34645	100
30335	162	34655	100
30340	163	34670	104
30345	164	34680	104
30347	164	34685	105
30350	165	34700	102
30390	255	34710	102
30395	255	34715	103
30400	149	34720	103
30420	150	34775	96
30425	151	34780	96
30450	152	34810	97
30615	153	34815	98
30617	155, 254	34830	101
30618	155, 254	36100	210, 240
30700	156	36105	207, 238

Fittings

Equipment &amp; Accessories

Assemblies

Installation &amp; Maintenance

Appendix

# Family Part Number - Alphanumeric Index

Product #

Product #	Page #	Product #	Page #
36115.....	208, 238	36830.....	197, 232
36120.....	208, 239	38351.....	251
36130.....	209, 239	38360.....	251
36170.....	209, 239	38400.....	246-247
36210.....	212, 242	38420.....	247
36215.....	213, 243	38425.....	248
36220.....	213, 243	38615.....	250
36225.....	214, 243	38745.....	251
36240.....	210, 240	38775.....	248
36245.....	211, 241	38777.....	248
36250.....	211, 241	38780.....	249
36255.....	212, 242	38800.....	249
36275.....	214, 244	38810.....	249
36280.....	215, 244	38815.....	250
36300.....	148, 206	50133.....	264
36310.....	206	50135.....	264
36315.....	207, 237	50137.....	264
36320.....	203, 236	50145.....	264
36330.....	203	50230.....	265
36335.....	204	50235.....	265
36340.....	204, 237	50240.....	265
36345.....	205	50250.....	291
36350.....	205, 237	50255.....	292
36360.....	197, 231	50260.....	292
36400.....	54, 187-188, 217-219	50350.....	266
36420.....	189, 220	50355.....	266
36425.....	190, 221-222	50365.....	266
36440.....	190, 221-222	50370.....	266
36445.....	190, 221-222	50375.....	267
36450.....	191, 223	50380.....	267
36520.....	216, 245	50401.....	292
36545.....	215, 244	50402.....	292
36548.....	216, 245	50403.....	292
36550.....	216, 245	50460.....	293
36600.....	194, 228	50500.....	267
36615.....	63, 195, 229	50503.....	267
36645.....	196, 230	50505.....	268
36650.....	196, 230	50515.....	268
36655.....	196, 231	50520.....	268
36670.....	201, 235	50530.....	268
36680.....	202, 236	50535.....	269
36685.....	202, 236	50600.....	269
36700.....	198, 232	50603.....	269
36710.....	199, 233	50605.....	270
36715.....	200, 233-234	50610.....	270
36720.....	200, 233-234	50615.....	270
36725.....	200, 233-234	50630.....	270
36730.....	201, 234	50633.....	271
36775.....	191, 224	50635.....	271
36777.....	192, 224	50650.....	271
36780.....	192, 225	50655.....	271
36781.....	192, 225	50660.....	272
36783.....	192, 225	50663.....	263, 272
36785.....	192, 226	50665.....	272
36800.....	193, 226	50675.....	272
36810.....	193, 227	50700.....	273
36815.....	194, 227	50703.....	273
36825.....	197, 231	50705.....	273

Hoses

Fittings

Equipment & Accessories

Assemblies

Installation & Maintenance

Appendix

## Family Part Number - Alphanumeric Index

Product #

Product #	Page #	Product #	Page #
50720	274	54615	285
50730	274	54650	285
50735	274	54655	286
50760	274	54660	286
50763	275	54663	286
50765	275	54665	286
50780	275	54675	286
50783	276	54700	287
50785	276	54703	287
50800	293	54705	287
50803	293	54720	288
50805	293	54730	288
50820	293	54735	288
50830	293	54760	288
50835	294	54763	289
50900	290	54765	289
50910	290	54780	289
50915	291	54783	290
50920	291	54785	290
50925	291	54850	294
54110	276	54855	294
54112	276	54860	294
54133	277	60061	305
54135	277	60062	305
54137	277	60200	46
54145	277	60210	46
54210	277	60300	47
54230	278	60500	304
54235	278	60505	303
54240	278	60515	303
54300	279	60520	303
54303	279	60525	304
54305	279	60530	304
54330	279	65090	294, 335-336
54333	280	65091	294
54335	280	70086290575800	306
54350	280	ACP3	I, M, 16, 37-38, 44-45
54355	280	ARC12	I, L, 17, 39-40, 44-45
54360	281	ARC13	I, L, 18, 39-40, 44-45
54365	281	ARC15	I, M, 19, 39-40, 44-45
54370	281	ARC16SC	I, M, 14, 37-38, 44-45
54375	281	Arctic® LR2SN	I, K, 12, 37-38, 43, 45
54380	282	BOP	A, N, 26, 39-40, 44-45
54430	282	BR7	J, L, 22, 39-40, 43, 45
54435	282	CB102	321
54450	292	CB103	321
54455	293	CB203	321
54500	282	CB204	321
54503	283	CB205	321
54505	283	CB206	321
54515	283	CB303	321
54520	283	Desert® DR16SC	I, J, M, 13, 37-38, 43, 45
54530	284	Desert® DR1SN	I, J, K, 11, 37-38, 43, 45
54535	284	Desert® DUT	J, K, 32, 41-43, 45
54600	284	DGF1	51, 298
54603	284	DGF2	51, 298
54605	285	DR1SN	I, J, K, 11, 37-38, 43, 45
54610	285	DR16SC	I, J, M, 13, 37-38, 43, 45

Fittings

Equipment &amp; Accessories

Assemblies

Installation &amp; Maintenance

Appendix



## Family Part Number - Alphanumeric Index

Product #

Product #	Page #	Product #	Page #
DR2SN.....	A, I, J, K, 12, 37-38, 43, 45	SR14A.....	J, L, 28, 41-42, 44-45
DR5.....	J, K, 30, 41-43, 45	SR15.....	J, L, 19, 39-40, 44-45
FXG.....	J, N, M, 9, 37-38, 44-45	SR16SC.....	I, M, 13, 37-38, 44-45
G4826.....	N, 33, 41-42, 336	SR18.....	M, 24, 39-40, 44-45
G4867.....	N, 33, 41-42, 335	SR1SN.....	I, K, 10, 37-38, 43, 45
G4890.....	N, 34, 41-42, 335	SR2SN.....	I, K, 11, 37-38, 43, 45
GC-Pliers-0001.....	294, 335	SR3.....	J, K, 7, 37-38, 43, 45
GFIT100.....	307	SR5.....	J, K, 29, 41-43, 45
HR4.....	J, K, 7, 37-38, 43, 45	SR6.....	J, K, 6, 37-38, 43, 45
HR6.....	J, L, 6, 37-38, 43, 45	SR7.....	L, 21, 39-40, 43, 45
HS150.....	319	SR8.....	L, 23, 39-40, 43, 45
HS301.....	320	TR7.....	L, 21, 39-40, 43, 45
HS303.....	320	TR8.....	L, 23, 39-40, 43, 45
HS501.....	320	UCF1.....	295
HS503.....	320	UCF10.....	298
IG.....	J, M, 8, 37-38, 44-45	UCF11.....	298
IGHT.....	J, M, 8, 37-38, 44-45	UCF2.....	295
IGTC.....	J, N, 9, 37-38, 44-45	UCF3.....	295
LR2SN.....	I, K, 12, 37-38, 43, 45	UCF4.....	296
MIL-DTL-13444H Type I.....	N, 34, 41-42, 45	UCF5.....	296
MIL-DTL-13444H Type III.....	N, 5, 35, 41-42, 44, 45	UCF6.....	296
MIL-DTL-13531 Type II.....	N, 35, 42, 44	UCF7.....	297
MIL-DTL-3992.....	N, 36, 41-42, 44-45	UCF8.....	297
MIL-DTL-8788.....	N, 36, 41-42, 44	UCF9.....	297
NR7.....	J, L, 22, 39-40, 43, 45	XCP3.....	A, I, M, 15, 37-38, 44-45
NR8.....	J, L, 24, 39-40, 43, 45	XR16SC.....	A, I, M, 14, 37-38, 44-45
NSFX.....	J, M, 25, 39-40, 43, 45		
PC1000.....	Q, 318		
PC1000-P.....	Q		
PC1000-PX.....	318		
PC125M.....	Q, 311		
PC125PS.....	Q		
PC125RCD.....	Q, 312		
PC150.....	Q, 313		
PC150H.....	Q, 314		
PC200.....	Q, 315-318		
PC200-P.....	Q		
PC200/400.....	317-318		
PC400.....	Q, 316		
PC440-P.....	Q		
PC600.....	Q, 317-318		
PC600L.....	Q, 317		
PC600L-P.....	Q		
PC900.....	311-316, 336		
PCTB.....	319		
Prospector™ BOP 3000.....	N, 26, 39-40, 44-45		
Prospector™ BOP 5000.....	A, N, 26, 39-40, 44-45		
Prospector™ Hot Oiler.....	A, N, 27, 39-40		
Prospector™ SHR.....	N, 25, 39-40, 44-45		
S4SH.....	J, L, 20, 39-40, 43, 45		
S4SP.....	J, L, 20, 39-40, 43, 45		
SCP3.....	I, M, 15, 37-38, 44, 45		
SCX5.....	K, 31, 41-43, 45		
SFS.....	I, M, 10, 37-38, 43, 45		
SGUN.....	M, 27, 39-40, 44-45		
SHJ.....	M, 28, 39-40, 44-45		
SR12.....	J, L, 17, 39-40, 43, 45		
SR13.....	J, L, 18, 39-40, 43-45		

Hoses

Fittings

Equipment &amp; Accessories

Assemblies

Installation &amp; Maintenance

Appendix





# ContiTech



## Contact

ContiTech  
NAFTA Headquarters  
703 S. Cleveland Massillon Road  
Fairlawn, OH 44333-3023 U.S.A.  
1-800-235-4632

## Canada

1-888-275-4397  
FAX 1-888-464-4397

## Mexico

1-800-439-7373  
FAX 1-800-062-0918

[www.contitech.us](http://www.contitech.us)

## ContiTech. Engineering Next Level

As a division of the Continental Group, ContiTech is a recognized innovation and technology leader in natural rubber and plastics. As an industry partner with a firm future ahead of us, we engineer solutions both with and for our customers around the world. Our bespoke solutions are specially tailored to meet the needs of the market. With extensive expertise in materials and processes, we are able to develop cutting-edge technologies while ensuring we make responsible use of resources. We are quick to respond to important technological trends, such as function integration, lightweight engineering and the reduction of complexity, and offer a range of relevant products and services. That way, when you need us, you'll find we're already there.