

AODDampener[™]

POWERED BY

BLACOH[™]
FLUID CONTROL



Installation and Operation Manual

When the dampener is sized correctly, properly installed and charged according to the instructions provided it will greatly reduce the damaging effects of pressure variations in piping systems and significantly improve the efficiency of transferring liquids.

All dampeners manufactured by BLACOH use pressure bodies made in the USA to ensure quality. Prior to shipment, each and every dampener is factory tested at design pressure or higher to assure proper function and leak-free operation.

Copyright © 2016 BLACOH Fluid Controls, Inc. All rights reserved.

Information in this document is subject to change without notice. No part of this publication may be reproduced, stored in a retrieval system or transmitted in any form or by any means electronic or mechanical, including photocopying and recording for any purpose other than the purchaser's personal use without the express written permission of BLACOH Fluid Controls, Inc.

Contents

SAFETY Warnings	1
Safety Symbols	1
General Safety	2
Equipment Misuse Hazard	2
GENERAL Information	3
Must Read Before Installation	3
Installation Notes	3
ATEX Standard	3
Temperature Limits	3
Maintenance	4
Installation & Operation Instructions: AODDAMPENER™ Models	4
Installation for Pump Discharge Pulsation	5
Maintenance and Repair	6
Manufacturer's Limited Warranty & Return Policy	10

MODEL Specifications & Installation Information

Installation Date _____

Model No.	Serial No.	Pump Area and Number

Purchased From	Contact	Phone	Email

SAFETY Warnings

Dampeners should only be installed, operated and repaired by experienced and trained professional mechanics. Read and observe all instructions and safety warnings in this Manual before installing, operating or repairing dampeners.

Safety Symbols

The following symbols indicate cautions, warnings and notes that must be observed for safe and satisfactory installation, operation and maintenance of dampener.



WARNINGS

Danger of serious injury or death could occur if these warnings are ignored.



CAUTIONS

Equipment damage, injury or death could occur if these cautions are not observed.



NOTES

Special instructions for safe and satisfactory installation, operation and maintenance.

General Safety

⚠ CAUTION!

- Observe all safety symbols in installation and operation instructions.
- The internal dampener pressure will equal the maximum fluid pressure of the system in which it is installed.
- **DO NOT** exceed maximum allowable working pressure (MAWP) specified on dampener serial tag or marked on dampener. If serial tag is missing, **DO NOT** use dampener without consulting distributor or factory for maximum pressure rating.
- Always make sure safety shutoff valves, regulators, pressure relief valves, gauges, etc. are working properly before starting system or assembly.
- Verify dampener model received against purchase order and shipper.
- Before starting a system or assembly make certain the discharge point of the piping system is clear and safe, and all persons have been warned to stand clear.
- **DO NOT** put your face or body near dampener when the system or assembly is operating or dampener is pressurized.
- **DO NOT** operate a dampener that is leaking, damaged, corroded or otherwise unable to contain internal fluid, air or gas pressure.
- **DO NOT** pump incompatible fluids through dampener. Consult distributor or factory if you are not sure of the compatibility of system fluids with dampener materials.
- AODDampener™ models are designed to operate with compressed air **only**. Other compressed gases have not been tested and may be unsafe to use. **DO NOT USE OXYGEN.**
- Always shut off air supply, remove internal dampener pressure and shut dampener isolation valve before performing dampener maintenance or repair.
- Remove all pressure from dampener AND pumping system before disassembly, removal or maintenance.
- **Static spark can cause an explosion resulting in severe injury or death. Ground dampeners and pumping system when pumping flammable fluids or operating in flammable environments.**
- **NOTE: EC standard EN-13463-1 and EN-13463-5 (ATEX) require grounding (earthing) on dampeners when the potential for static sparking is present. A grounding point is located and marked on ATEX specific dampener models.**

Equipment Misuse Hazard

⚠ CAUTION!

General Safety

DO NOT misuse dampener, including but not limited to over-pressurization, modification of parts, using incompatible chemicals, or operating with worn or damaged parts. **DO NOT** use any gases other than compressed air to charge dampener. **DO NOT USE OXYGEN.** Any misuse could result in serious bodily injury, death, fire, explosion or property damage.

Over-Pressurization

Never exceed the maximum pressure rating for the dampener model being used. Maximum allowable working pressure (MAWP) is specified on dampener serial tag or marked on dampener. Maximum allowable working pressure (MAWP) is rated at 70°F (21°C).

Temperature Limits

DO NOT exceed the operating temperature limits for the body and/or diaphragm materials being used. Excessive temperature will result in dampener failure. For temperature limits, refer to the "Temperature Limits" section of this Manual. Temperature limits are stated at zero psi/bar.

Installation and Startup Hazards

Install dampener before charging or pressurizing. **DO NOT** start system or assembly without first charging or pressurizing dampener. Failure to charge may result in damage to the PTFE diaphragm.

Temperature & Pressure Hazard

Temperature and pressure reduce the strength and chemical resistance of plastic, metal, elastomers and PTFE.

Charging / Pressurization

Charge or pressurize dampener with clean compressed air only. **DO NOT USE OXYGEN.**

Dampener Diaphragm Failure

AODDampener™ models utilize a PTFE diaphragm to separate system fluid from the air supply. When failure occurs, system fluid may be expelled from the air valve. Always perform preventive maintenance and replace diaphragm before excessive wear occurs.









Maintenance Hazards

Never over-tighten fasteners. This may cause leakage of system fluid and damage to dampener body. Bolts should not be reused as re-torquing reduces bolt strength. **After dampener maintenance or reassembly, use new fasteners and torque fasteners according to specification on dampener. If missing, consult distributor or factory for torque specifications.**





GENERAL Information

-  For safe and satisfactory operation of dampener read all safety warnings, caution statements and this complete Manual before installation, startup, operation or maintenance.

Must Read Before Installation

-  **DO NOT** use Oxygen to charge dampener. Use clean compressed air only.
-  **DO NOT** exceed maximum allowable working pressure (MAWP) specified on dampener serial tag or marked on dampener.
-  Turn pump off and remove all pressure from system prior to dampener installation.
-  Always wear safety glasses and other appropriate safety equipment when installing, charging or repairing dampener.
-  **Danger of static spark!** Grounding precautions must be considered when dampener is used in flammable or explosive environments.
-  ATEX models must be grounded (earthed) before operation.
-  **DO NOT** operate a dampener that is leaking, damaged, corroded or otherwise unable to contain internal fluid, air or gas pressure.
-  Temperature, pressure and chemicals affect the strength of plastic, elastomer and metal components.
-  Due to the nature of the material, PTFE diaphragm will *cold flow*. Prior to installation, tighten bolts to torque specification on dampener tag.

Installation Notes

-  Dampening of flow pulsations can only be effective if a minimum of 5 to 10 psi (0.4 to 0.7 bar) back pressure downstream of dampener is available. A BLACOH back pressure valve may be required downstream of dampener, except when dampener is used as an inlet stabilizer for the inlet side of the pump.
-  It is recommended that a BLACOH pressure relief valve be installed in all pump systems to ensure compliance with pressure limits on system equipment.
-  To avoid possible damage to diaphragm from a system pressure test, prior to test dampener must be equipped with a constant source of compressed air with pressure equal to or greater than system test pressure.
-  Install dampener in-line as close to the pump discharge/inlet or quick closing valve as possible. Dampener installation should be no more than ten pipe diameters from pump discharge/inlet or quick closing valve.
-  It is recommended that an isolation valve be installed between the dampener and system piping.

ATEX Standard

-  Certain models made for the European market comply with the ATEX standard for use in potentially explosive atmospheres. These models have the AT designation at the end of the part number and comply with EC standard EN-13463-5 with protection degree of II 2 GD IIB T4. AT models have a grounding lug and must be grounded (earthed) before operation.

Temperature Limits

-  Operating temperatures are based on the maximum temperature of the wetted dampener components only. Non-wetted dampener components may have a lower temperature limit. Temperature and certain chemicals may reduce the maximum allowable working pressure (MAWP) of the dampener.

Elastomer Materials	Temperature Limits	
Buna-N	+10°F to +180°F	(-12°C to +82°C)
PTFE Diaphragm	+40°F to +220°F	(+4°C to +104°C)

Maintenance

-  **Remove all pressure from dampener AND pumping system before disassembly, removal or maintenance. Refer to Installation & Operation Instructions, Maintenance and Repair section below for detailed procedure.**

Dampeners require very little maintenance.

PTFE diaphragm replacement should be part of a preventive maintenance program. As with any pumping system, wear is dependent on many factors including material, temperature, chemicals, fluid abrasiveness and system design.

Periodic inspection of the dampener and fasteners should be conducted to visually check for signs of over-pressurization, fatigue, stress or corrosion. Body housings and fasteners must be replaced at first indication of deterioration.

-  **CAUTION! Replace nut and bolt fasteners at each reassembly with fasteners of equal grade/strength value. DO NOT reuse old nuts and bolts.**

After the initial torque of fasteners, bolts may lose strength when re-torqued. Failure to replace both nuts and bolts upon each vessel reassembly will void the product warranty given by the manufacturer and the manufacturer will have no liability whatsoever for any vessel failure or malfunction.

Where dampeners are used in corrosive environments, nut and bolt fasteners should be regularly inspected and replaced with nut and bolt fasteners of equal grade/strength value if corrosion is observed. Failure to conduct such regular inspections and replacement will void the product warranty given by the manufacturer and the manufacturer will have no liability whatsoever for any vessel failure or malfunction.

-  **IMPORTANT!** After maintenance or reassembly, use new fasteners and torque fasteners according to specification on dampener. If missing, consult distributor or factory for specifications.

-  **DO NOT** use dampener if the fasteners (nuts and bolts) are corroded. Check for fastener corrosion frequently, especially in atmospheres containing salt or corrosive chemicals, or if dampener leakage has occurred.

Installation & Operation Instructions: AODDAMPENER™ Models

-  **AODDAMPENER™ automatic dampener models are designed specifically for use with air operated diaphragm pumps, and are not recommended for use as Inlet Stabilizers at pump inlets or as Surge Suppressors at quick closing valves. Use Inlet Stabilizer models on the inlet side of pumps and metal Surge Suppressors for water hammer or quick closing valve applications. Consult factory for options.**

-  **ATEX models must be grounded (earthed) before operation.**

-  Turn pump off and remove all pressure from system prior to dampener installation.

-  Remove all pressure from dampener AND pumping system before disassembly, removal or maintenance.

-  Equip dampener with constant source of clean compressed air. **DO NOT USE OXYGEN.**

-  **DO NOT exceed 150 psi (10.3 bar) maximum allowable working pressure (MAWP). Check maximum pressure rating specified on dampener.** If missing, consult distributor or factory for specifications.

-  Always wear safety glasses and other appropriate safety equipment when installing, charging or repairing dampener.

-  Read and observe all safety warnings and instructions in this Manual before installation, operation or repair.

-  **IMPORTANT! After maintenance or reassembly, use new fasteners and torque fasteners according to specification on dampener tag.** If tag is missing, consult distributor or factory for specifications.

-  Before performing a system pressure test, an air line with a constant source of compressed air must be attached to dampener to avoid possible damage to diaphragms. Compressed air pressure must be equal to or greater than system test pressure.

Installation for Pump Discharge Pulsation

Read Before Installation

- ⚠ Due to the nature of the material, PTFE diaphragm will *cold flow*. Prior to installation, tighten bolts to torque specification on dampener tag.

Step 1 — INSTALLATION POSITION

Install the dampener in-line as close to the pump discharge as possible to absorb the pulse at its source and before any downstream equipment such as risers, valves, elbows, meters or filters. Dampener installation should be no more than ten pipe diameters from pump discharge. If using a flexible connector on the discharge side of the pump between the pump and system piping, the dampener should be installed at the pump discharge manifold. The flexible connector should be attached to the dampener's tee and system piping (see FIGURE 1). Since pressure is equal in all directions, the dampener can be installed in a vertical, horizontal or upside-down position. A vertical installation is recommended for better drainage of the dampener. Limitations for horizontal and upside-down mounting include high specific gravity, high viscosity, settling of solid material or possible air entrapment which could result in shortened diaphragm life and/or reduced dampening performance. An isolation valve installed at the dampener inlet is suggested to assist in removal for repairs (see FIGURE 1).

FIGURE 1

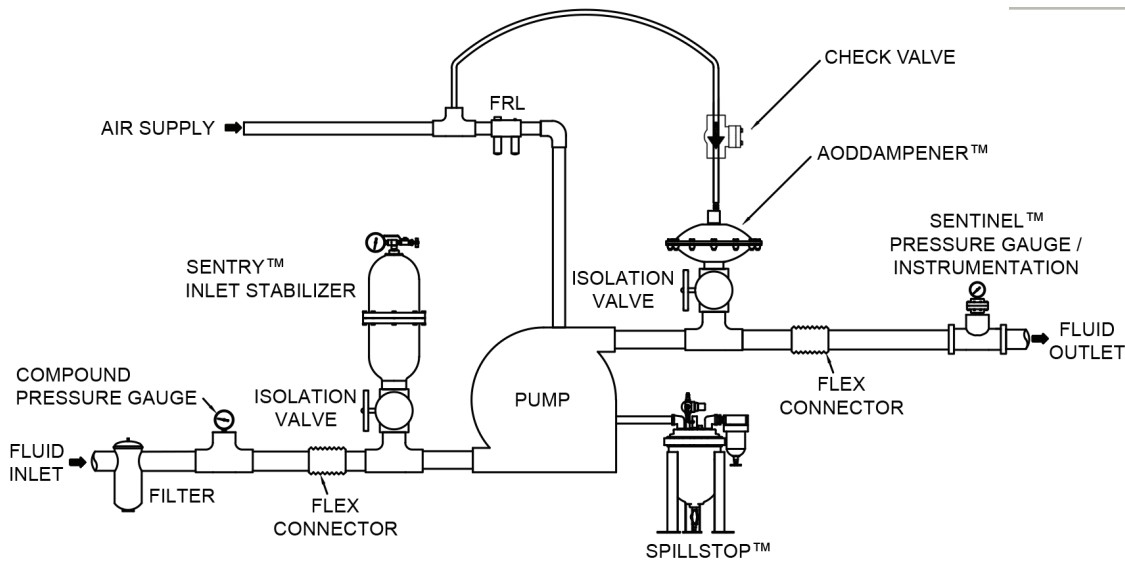

Step 2 — AIR LINE CONNECTION

AODDAMPENER™ models have an automatic valve with two 1/8" NPT ports fitted in the non-wetted (top) housing. Supply compressed air to the unit using a 1/4" or larger air line to ensure adequate air supply to the dampener. Using a suitable adapter, connect the air line to the 1/8" NPT inlet connection indicated by the arrow. Attach the air line to the plant's compressed air system upstream of any regulator used at the pump's air valve (see FIGURE 1). The compressed air pressure to the dampener must be equal to or greater than the air pressure supplied to the pump.

Compressed air should be applied to the dampener charge port at all times. Failure to maintain a charge to the dampener may result in damage to the PTFE diaphragm. In case the compressed air supply to the dampener is interrupted, it is recommended that a check valve be added to the compressed air supply line to prevent the charge from escaping through the air inlet while the dampener is depressurized.



- ⚠ The exhaust port in the automatic valve is supplied with a breather plug. Dampener will not operate if the exhaust port is blocked or, if an air supply is attached to that port.
- ⚠ If a diaphragm failure occurs, it is possible for the pumped product to enter the dampener air chamber and into the compressed air line. It is recommended that a one-way check valve be installed at the air connection to prevent backflow of product.

Step 3 — STARTUP

- ⚠ To avoid damage to diaphragms, DO NOT start the pump before compressed air is supplied to dampener.

Prior to starting the pump, dampener must have the air supply connected and available to the dampener to avoid possible damage to diaphragms. Once the air supply connection is complete, dampener is fully functional and will operate automatically when the pump is started.

- ⚠ DO NOT use dampener if the fasteners (nuts and bolts) are corroded. Check for fastener corrosion frequently, especially in atmospheres containing salt or corrosive chemicals, or if dampener leakage has occurred.
- ⚠ Regularly inspect compressed air line for damage. If compressed air to dampener is reduced or stopped, diaphragm failure will occur.

DIAPHRAGM REPLACEMENT KITS

Diaphragm replacement kits include all parts necessary for replacement, including hardware and O-rings.

AODDAMPENER™	AOD-10	AOD-15	AOD-20
REPLACEMENT KIT	AOD-10-100	AOD-15-100	AOD-20-100
REPLACEMENT KIT - ATEX	AOD-10-100-AT	AOD-15-100-AT	AOD-20-100-AT

REMOVE DAMPENER FROM SERVICE

- ⚠ Pump must be turned off and system pressure must be zero prior to disassembly. In systems with a static head pressure, it is not sufficient to simply isolate the dampener. To prevent damage to the PTFE diaphragm, fluid system pressure must be relieved prior to removing the charge pressure from the diaphragm.
1. Turn pump off and allow system pressure to drop to zero pressure.
 2. Disconnect compressed air line to dampener.
 3. Close isolation valve (if installed) on dampener inlet. Dampener can be repaired in place but, the preferred method is to remove it from the system.
 4. Remove and clean any thread sealant at the connection to the piping system.

DISASSEMBLY

1. There should be no residual pressure in dampener, however; slowly loosen all fasteners first to slowly release any remaining pressure before removing fasteners. Discard used fasteners; new fasteners are supplied with diaphragm replacement kits.

- ⚠ Replace nut and bolt fasteners at each reassembly with fasteners of equal/greater strength value. DO NOT reuse old nuts and bolts.

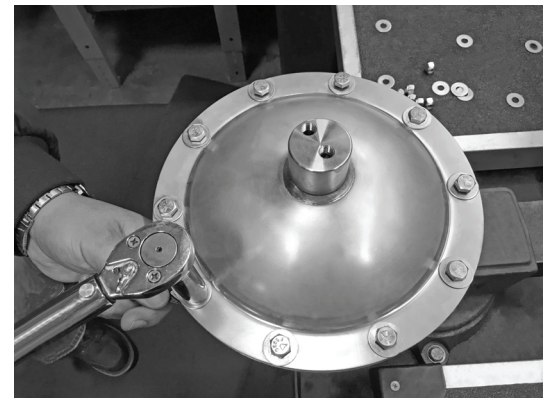

2. Remove non-wetted (top) section of dampener.

- ⚠ Process liquid may be present if diaphragm failure has occurred. Always wear safety glasses and other appropriate safety equipment when disassembling dampener.



DIAPHRAGM REPLACEMENT

1. The diaphragm is attached to the automatic valve shaft. Gently pull down on the diaphragm to slide the shaft out from the automatic valve body. If the shaft does not slide out easily, remove the breather plug, insert a small screwdriver through the hole and push the top end of the shaft down. Take necessary precautions not to scratch or damage the shaft or the automatic valve may not function properly.

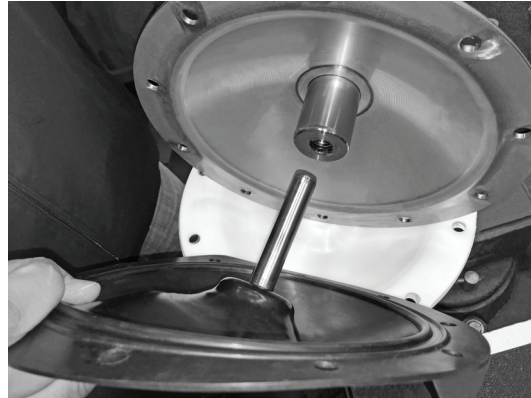

2. To remove the shaft from the diaphragm, secure the shaft in a vise with soft jaws. NOTE: Soft jaws or wood blocks protect the shaft from nicks and scratches. Hold the used diaphragm with two hands and gently turn it counterclockwise to unscrew it from the shaft. Discard the old diaphragm.

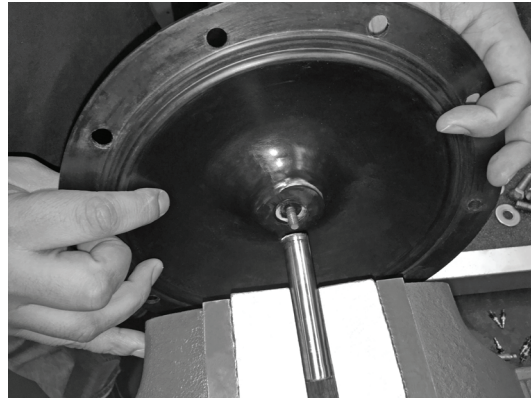
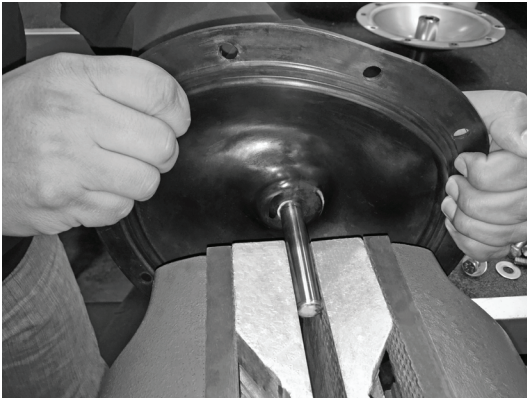

3. There are no special tools required to install the new diaphragm. Apply medium strength thread locker (such as Loctite® 243 or equivalent) to the threads on the new diaphragm. Gently screw the diaphragm threads into the shaft with two hands and stop when hand tight. Remove the diaphragm and shaft from the vise.

O-RING REPLACEMENT

It is recommended that the O-rings in the automatic valve be replaced with each diaphragm replacement. There are three O-rings in the automatic valve body (see FIGURE 2). Diaphragm replacement kits include new O-rings.

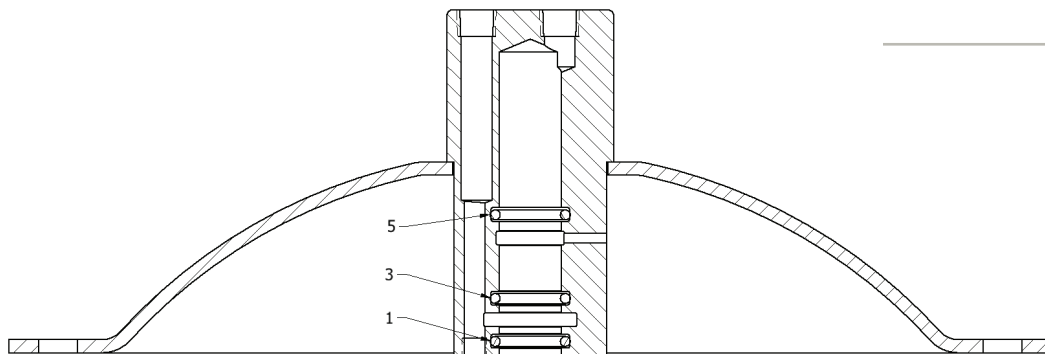
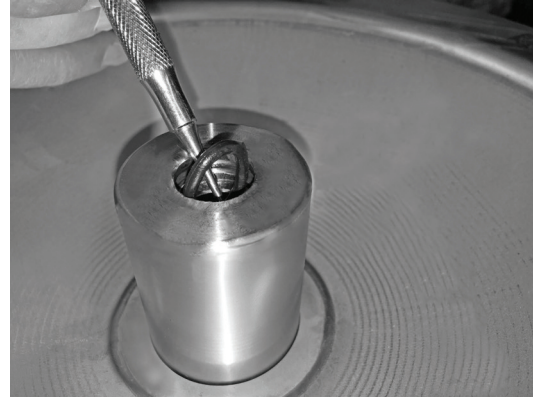
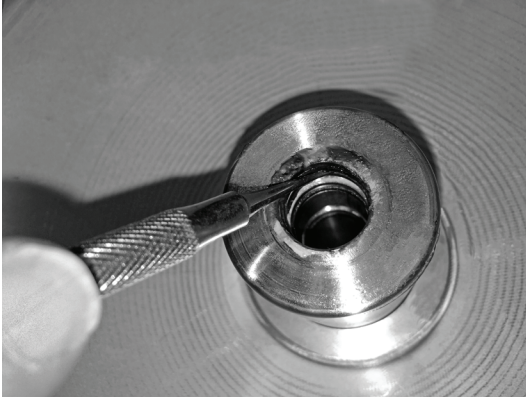

FIGURE 2

1. Secure the dampener non-wetted (top) housing into a vise with soft jaws with the inside (interior) of dampener facing up. Using an O-ring pick, remove and discard the old O-rings.



2. There are five grooves in the automatic valve body. O-rings are installed in grooves number 5, 3 and 1 in that order (see FIGURE 2). Automatic valve will not operate if O-rings are installed in the wrong grooves. Install the first O-ring in groove number 5, the second O-ring in groove number 3 and lastly, install the third O-ring in groove number 1.

TIP: Push the O-ring into the valve body past the intended groove and then pull it back into the intended groove using an O-ring pick.

3. Apply a thin coat of O-ring lubricant (such as Molycote® 55 or equivalent) on the inside of the valve shaft opening, ensuring the O-rings are adequately coated.
4. Clean and dry the internal housing surface, taking particular care to ensure the flange area is clean and dry.



AUTOMATIC VALVE TEST

△ IMPORTANT! When replacing dampener diaphragms the automatic valve must be tested for proper function before dampener is reassembled.

1. Attach a compressed air line to the air inlet port on the top of dampener.
2. Install the dampener shaft into the automatic valve body.
3. Push the diaphragm and shaft into the automatic valve until it stops. Compressed air should now be flowing into the air chamber. If there is no air flow, one or more O-rings are installed in the wrong groove.
4. Pull the diaphragm shaft downward and compressed air should stop flowing. If air flow does not stop, one or more O-rings are installed in the wrong groove.
5. Remove top housing from the vise.

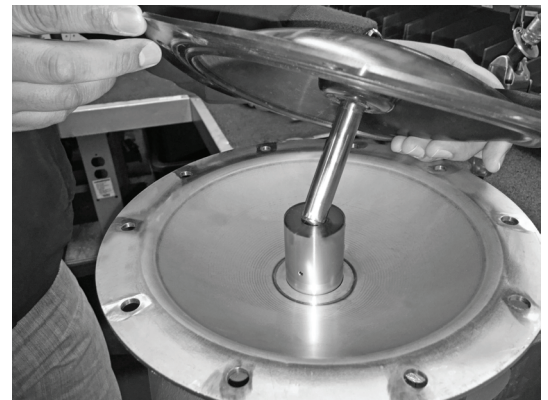

REASSEMBLY

1. Place dampener wetted (bottom) housing in a vise, clamping the inlet neck between soft jaws.
2. Clean and dry the internal housing surface, taking particular care to ensure the flange area is clean and dry.



3. Place the PTFE diaphragm in the wetted (bottom) housing with the dome (convex) side down.

4. Place the non-wetted (top) housing and diaphragm sub-assembly onto the wetted (bottom) housing with bolt holes aligned. Ensure the diaphragms fit together snugly to minimize any air between them.

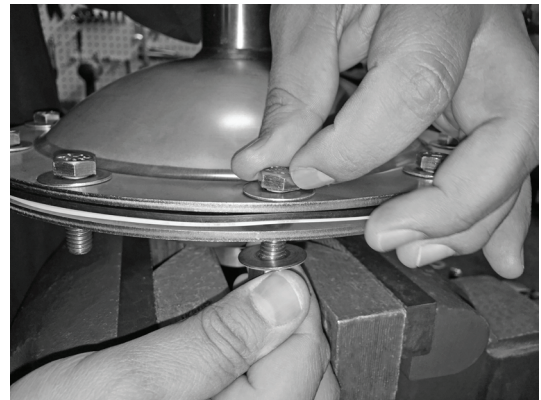

5. Insert bolts with flat washers through the top side.
 - 1" inlet model, 3/8" hardware
 - 1 1/2" and 2" inlet models, 7/16" hardware

6. Attach flat washers and lock nuts on the bottom side for each bolt.

7. Torque bolts in star pattern according to the following torque specifications:

- 1" inlet model, (10) 3/8" bolts - **17 ft-lb / 23 Nm**
- 1 1/2" and 2" inlet models, (12) 7/16" bolts - **30 ft-lb / 40 Nm**

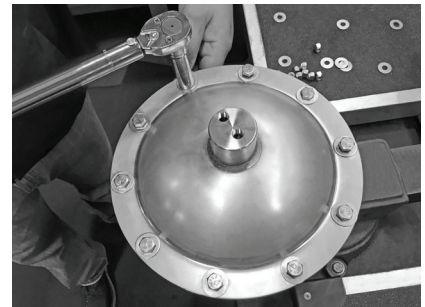
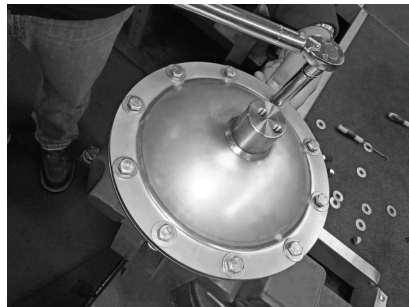
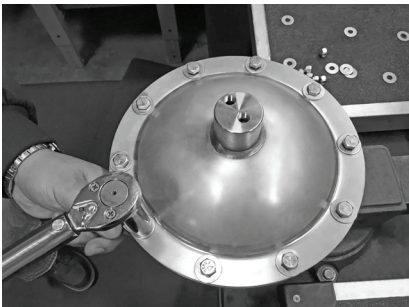

Manufacturer's Limited Warranty & Return Policy

Standard Product Limited Warranty

Subject to the limitations set forth below, BLACOH Fluid Controls, Inc. ("BLACOH") warrants its products to be free from defects in material and workmanship under normal use, service, and maintenance in accord with BLACOH's published specifications for a period of two years from date of shipment by BLACOH (the "Warranty"). The EXCLUSIVE REMEDY for any product defect covered under this Warranty shall be one of the following, as determined by BLACOH in BLACOH's sole discretion: (a) refund of the purchase price; or (b) replacement or repair of the defective part or parts at BLACOH's facility. This Warranty will be null and void if the product is used in an inappropriate application or if the product has been altered, misapplied, improperly installed, or not properly inspected and maintained. To the maximum extent allowed by applicable law, BLACOH will not be responsible for nor have any liability for any "Damage," which means any of the following, whether the claim sounds in breach of contract, breach of warranty, tort, strict liability, implied contractual indemnity, or otherwise: (i) any damage, loss, or injury of any kind, or destruction, or death, whether or not caused by any defect in a BLACOH product and whether or not the BLACOH product is installed, used, operated, and/or maintained in accord with BLACOH instructions, to other products, machinery, buildings, property, or persons, and (ii) any costs, expenses, losses, or incidental, consequential, or special damages of any kind or nature, including but not limited to loss of profits, arising from or related to any BLACOH product, whether or not caused by any defect in a BLACOH product and whether or not the BLACOH product is installed, used, operated, and/or maintained in accord with BLACOH instructions. Damage resulting from chemical incompatibility or from over-pressurization of a product, whether from gas or fluid, is not covered under this Warranty, nor will BLACOH be responsible in any way for any such Damage. Because BLACOH does not determine and cannot anticipate or control the many different conditions under which its products may be used, BLACOH does not warrant the applicability, suitability, or fitness of any of its products for any particular use or purpose. Statements concerning the possible use of BLACOH products are not intended and shall not be interpreted as warranties of fitness for any specific use of such products. Each user of BLACOH products must conduct its own engineering analysis and tests to determine the suitability of each BLACOH product for the user's intended uses or purposes, including but not limited to chemical compatibility and pressurization, and any written or oral assistance from BLACOH in this regard does not relieve the user from exclusive responsibility for such engineering analysis and testing. BLACOH products are sold with only this limited Warranty, and each buyer assumes all responsibility for Damage (as defined above), including but not limited to, Damage arising from defects in BLACOH products and/or from the handling and use of BLACOH products whether used in accordance with BLACOH's directions or otherwise. Any products sold by BLACOH which are manufactured by and sold under the name of another company are NOT WARRANTED by BLACOH under the foregoing Warranty or otherwise. The buyer must rely exclusively on the product warranty, if any, given by such other company. Products manufactured by BLACOH as an original equipment manufacturer (OEM) to be sold by a customer under the customer's brand and name are warranted by BLACOH only under the above Warranty, and BLACOH shall have no liability whatsoever with respect to any representation or warranty given by such customer (or such customer's representatives, distributors, agents, employees, or independent contractors) to any of its buyers which is different in any respect whatsoever from the foregoing Warranty. EXCEPT FOR THE WARRANTY GIVEN ABOVE, WHICH IS SUBJECT TO THE ADDITIONAL LIMITATIONS STATED ABOVE, BLACOH GIVES NO WARRANTY OF ANY NATURE WHATSOEVER, EXPRESS OR IMPLIED, WITH RESPECT TO ANY OF ITS PRODUCTS, INCLUDING WITHOUT LIMITATION NO WARRANTY OF MERCHANTABILITY AND NO WARRANTY OF FITNESS FOR A PARTICULAR PURPOSE. NO COURSE OF DEALING, USAGE OF TRADE, OR OTHER ORAL OR WRITTEN STATEMENTS SHALL MODIFY THE FOREGOING WARRANTY PROVISIONS AND LIMITATIONS IN ANY RESPECT WHATSOEVER. This Warranty shall be governed by and construed in accordance with the laws of the State of California.

Warranty Claims

1. Prior to returning any product to BLACOH based on a claim of breach of Warranty, a BLACOH Return Request form must be completed. The form will be reviewed by BLACOH to determine if a Return Merchandise Authorization (RMA) number will be issued. The issuance of an RMA number does not constitute BLACOH's acknowledgment or agreement that the warranty claim is justified or correct.
2. If an RMA number is issued by BLACOH, customer should then deliver the product in question to the address specified on the RMA, freight prepaid.
3. All products so returned to BLACOH based on a claim of breach of Warranty must be cleaned, sanitized and neutralized prior to shipment to BLACOH. BLACOH will not accept any part that contains corrosive chemicals, organic cultures, blood, any harmful residue or air borne materials that might contaminate a breathable atmosphere or put at risk any person or property. Any shipment that does not comply will be returned at the expense of the customer, or the customer will be required to arrange for pickup.
4. HAZMAT SHIPMENTS WILL BE REMOVED AND PROCESSED AT CUSTOMER'S EXPENSE.
5. Receipt by BLACOH of a return does not constitute BLACOH's agreement that BLACOH is in breach of its Warranty.
6. If BLACOH determines that a defect in workmanship or material of a part has occurred, customer is not entitled to a complete unit replacement. In the event of such a defect, BLACOH will repair or replace the defective part or parts or refund the purchase price, as BLACOH determines in BLACOH's sole discretion.

New Product Returns

1. If a customer wishes to return a new, unused product, the customer must first request a Return Merchandise Authorization (RMA) number from BLACOH. BLACOH will determine if the unit can be returned for possible credit.
2. Product to be returned must be new, unused, and of current design and purchased within thirty (30) days of the return request. In addition the product must not have been damaged after original shipment by BLACOH.
3. Product returns must be delivered, freight prepaid.
4. BLACOH has the right to inspect all returned products prior to acceptance or rejection.
5. ALL RETURNS are subject to a minimum \$50.00 or 30% restocking fee, whichever is greater. (Higher restocking fees may be charged on special items and some models may not be eligible for return). Returns accepted by BLACOH will be credited to the customer's account less the re-stocking fee. Refunds will not be issued.
6. Any outsourced product supplied by BLACOH will be subject to the warranty, return policy and re-stock fee charged by the manufacturer of the outsourced product.

[L11E11_060_A01]



CALIFORNIA • ARIZONA • INDIANA • LOUISIANA
ARGENTINA • AUSTRALIA • AUSTRIA • CHINA • GERMANY • KOREA

AODDampener™

PROUDLY MANUFACTURED IN THE USA

BLACOH HEADQUARTERS

601 Columbia Ave, Bldg D, Riverside, CA 92507 USA
Phone 951.342.3100 or 800.603.7867 Fax 951.342.3101
Email Sales@Blacoh.com Visit www.Blacoh.com